



EESTI VABARIIK

T **EESTI**
TÖÖSTUSDISAINI-
LAHENDUSE LEHT



PATENDIAMETI AMETLIK VÄLJAANNE

2
2004
TALLINN



ISSN 1406-376X

EESTI VABARIIK

T **EESTI**
TÖÖSTUSDISAINI-
LAHENDUSE LEHT

**PATENDIAMETI
AMETLIK VÄLJAANNE**

VII aastakäik

**Käesolevas numbris
esitatud andmed
loetakse avaldatuks
17. mail 2004. a.**

2
2004
MAI
TALLINN

Eesti Tööstusdisainilahenduse Lehte antakse välja tööstusdisaini kaitse seaduse (jõustunud 11.01.1998) alusel.
The Estonian Industrial Design Gazette is the official publication of the Estonian Patent Office.
Published under Industrial Design Protection Law of the Republic of Estonia (coming into force 11 January 1998).
Date of publication of the data presented in this issue - 17 May 2004.

Patendiameti
infoosakond
Toompuiestee 7
15041 Tallinn
Tel. 627 7907
Faks 627 7943
E-post: Info@epa.ee

The Information Department
of the Estonian Patent Office
Toompuiestee 7
15041 Tallinn, ESTONIA
Phone +372 627 7907
Fax +372 627 7943
E-mail: Info@epa.ee

Levitaja

Eesti Patendiraamatukogu
Olevimägi 8/10
10123 Tallinn
Tel. 641 1248
Faks 641 1018
E-post: patent@patentlib.ee

Distributor

Estonian Patent Library
Olevimägi 8/10
10123 Tallinn, ESTONIA
Phone +372 641 1248
Fax +372 641 1018
E-mail: patent@patentlib.ee

SISUKORD

Andmete identifitseerimise rahvusvahelised numberkoodid (INID-koodid)	4
I. REGISTREERITUD TÖÖSTUSDISAINILAHENDUSED	5
II. TÖÖSTUSDISAINILAHENDUSE REGISTREERINGU KEHTIVUSE PIKENDAMINE	75
III. TÖÖSTUSDISAINILAHENDUSE REGISTREERINGU ANDMETE MUUTMINE	75
IV. TÖÖSTUSDISAINILAHENDUSE OMANIKU ÕIGUSTE KASUTUSVALDUSSE ANDMINE	-
V. TÖÖSTUSDISAINILAHENDUSE REGISTREERINGU KUSTUTAMINE	75
VI. TÖÖSTUSDISAINILAHENDUSE TUNNISTUSE DUPLIKAADI VÄLJASTAMINE	-
VII. LOENDID	76
Registreeritud tööstusdisainilahenduste süstemaatiline loend	76
Registreeritud tööstusdisainilahenduste registreerimistaotluste numbriline loend	77
VIII. TÖÖSTUSDISAINIALASED ÕIGUSAKTID JA MUU INFO	78
Riiklikus patendivolnike registris registreeritud patendivolnike nimekiri	78
Riikide, teiste ühenduste ja valitsustevaheliste organisatsioonide koodid	85

CONTENTS

Internationally Agreed Numbers for the Identification of Data (INID Codes)	4
I. REGISTERED INDUSTRIAL DESIGNS	5
II. RENEWAL OF TERM OF INDUSTRIAL DESIGN	75
III. CHANGE IN DATA RELATING TO THE REGISTRATION OF INDUSTRIAL DESIGN	75
IV. TRANSFER OF RIGHTS OF PROPRIETOR OF INDUSTRIAL DESIGN INTO USUFRUCT.	-
V. DELETION OF INDUSTRIAL DESIGN REGISTRATION	75
VI. ISSUE OF A DUPLICATE OF INDUSTRIAL DESIGN CERTIFICATE	-
VII. LISTS	76
Systematic List of Registered Industrial Designs	76
Numerical List of Registration Applications of Registered Industrial Designs	77
VIII. LEGAL ACTS AND INFORMATION.	78
List of Patent Attorneys, Registered in the Estonian State Register of Patent Attorneys	81
List of Codes of States, Other Entities and Intergovernmental Organizations	85

**ANDMETE IDENTIFITSEERIMISE
RAHVUSVAHELISED NUMBERKOODID
(INID-KOODID)**

**INTERNATIONALLY AGREED NUMBERS FOR
THE IDENTIFICATION OF DATA
(INID CODES)**

(11) Registreeringu number	(11) Number of the Registration
(15) Registreerimise kuupäev	(15) Date of the Registration
(18) Registreeringu kehtivuse lõppemise kuupäev	(18) Expected expiration date of the registration
(21) Registreerimistaotluse number	(21) Application Number
(22) Registreerimistaotluse esitamise kuupäev	(22) Application Filing Date
(24) Registreeringu kehtivuse alguse kuupäev	(24) Date from which the Industrial Design Right Has Effected
(28) Variantide arv	(28) Number of Industrial Designs Included in the Application
(30) Prioriteet	(30) Priority
(51) Rahvusvahelise klassifikatsiooni klassi ja alaklassi number	(51) International Classification for Industrial Designs (class and subclass of the Locarno Classification)
(54) Tööstusdisainilahenduse nimetus	(54) Title of the Industrial Design
(55) Tööstusdisainilahenduse reproduktsioon	(55) Reproduction of the Industrial Design
(72) Tööstusdisainilahenduse autor(id)	(72) Author(s) of Industrial Design
(73) Tööstusdisainilahenduse omanik(ud)	(73) Proprietor(s) of Industrial Design
(74) Patendivolinik või ühine esindaja	(74) Patent Attorney or Common Representative

I. REGISTREERITUD TÖÖSTUSDISAINILAHENDUSED

(Avaldatakse tööstusdisaini kaitse seaduse § 58 lõike 8 alusel)
Patendiamet ei ole kontrollinud tööstusdisainilahenduse uudsust ja eristatavust tulenevalt
tööstusdisaini kaitse seaduse § 31 lõike 2 punktist 1

- (11) Registreeringu number: **00883**
- (15) Registreerimise kuupäev: 30.01.2004
- (21) Taotluse number: D200300117
- (22) Esitamise kuupäev: 27.10.2003
- (24) Registreeringu kehtivuse alguse kuupäev: 27.10.2003
- (28) Variantide arv: 1
- (72) Autor: Karin Tiisler, Võru tn 4, 63308 Põlva, EE
- (73) Omanik: Karin Tiisler, Võru tn 4, 63308 Põlva, EE

(51) Klass: **25-01**

(54) Nimetus: **Klaasist katteplaat**

(55) Reproduksioon:

00883-01

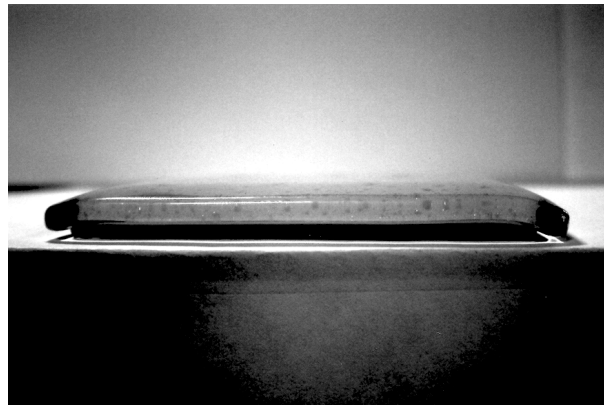

- (11) Registreeringu number: **00884** (51) Klass: **14-03**
- (15) Registreerimise kuupäev: 30.01.2004
- (21) Taotluse number: D200300125
- (22) Esitamise kuupäev: 11.11.2003
- (24) Registreeringu kehtivuse alguse kuupäev: 11.11.2003
- (28) Variantide arv: 1
- (30) Prioriteediandmed: 2003-033612, 06.10.2003, JP
- (72) Autor: Hiroshi Yasutomi, c/o Sony Corporation, 7-35, Kitashinagawa 6-chome, Shinagawa-ku, Tokyo, JP
- (73) Omanik: Sony Computer Entertainment Inc., 2-6-21, Minami-Aoyama, Minato-ku, Tokyo 107-0062, JP
- (74) Patendivolinik või ühine esindaja: Kaie Puur

(54) Nimetus: **Kaugjuhtimispuult**

(55) Reproduktsoon:

00884-01

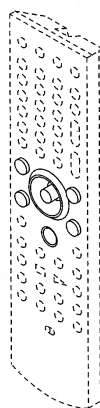
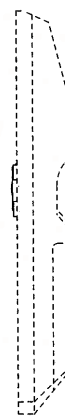
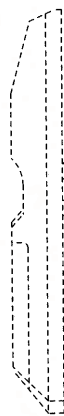
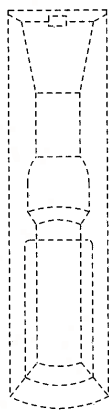
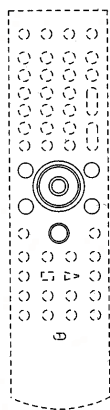

(11) Registreeringu number: **00885**

(51) Klass: **21-01, 21-03**

(15) Registreerimise kuupäev: 30.01.2004

(21) Taotluse number: D200300129

(22) Esitamise kuupäev: 20.11.2003

(24) Registreeringu kehtivuse
alguse kuupäev: 20.11.2003

(28) Variantide arv: 1

(72) Autor: Ivari Männi, Lauteri 1-55, 10117 Tallinn, EE

(73) Omanik: MÄNNI DISAINI OÜ, Lauteri 1-55, 10117 Tallinn, EE

(74) Patendivolinik või ühine esindaja: Ott Moorlat

(54) Nimetus: **Veepiljard "SUPERNOVA"**

(55) Reproduktsoon:

00885-01

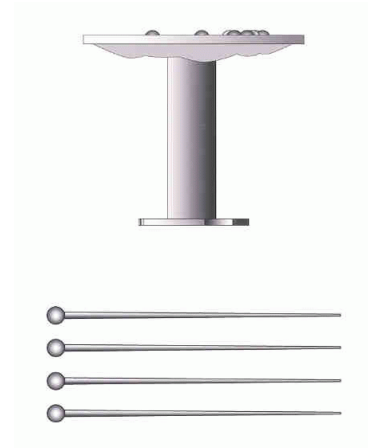
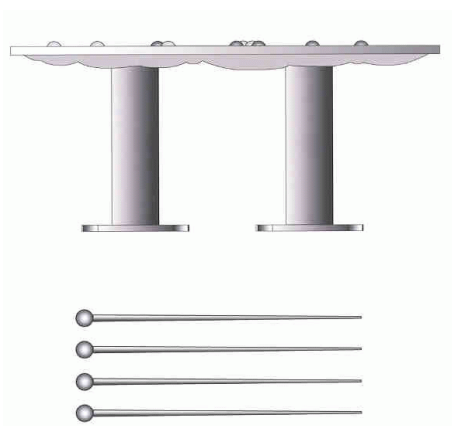
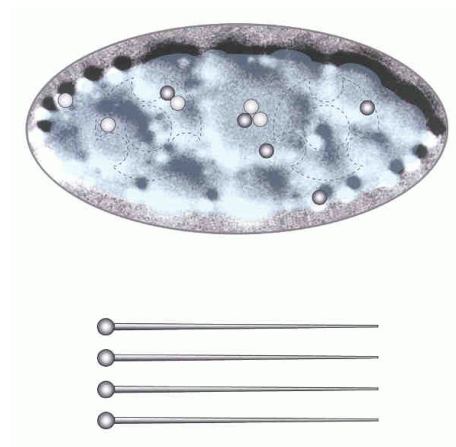
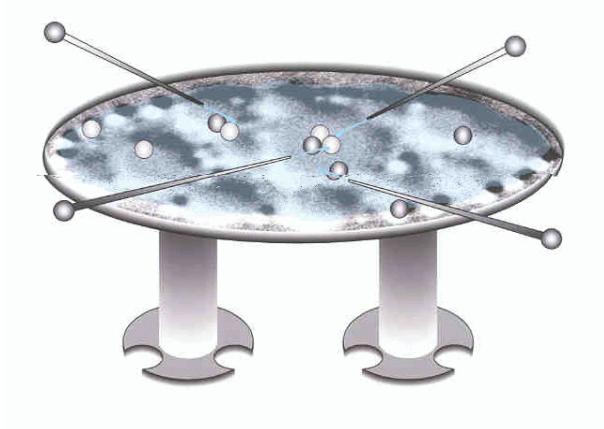

- (11) Registreeringu number: **00886** (51) Klass: **14-03**
- (15) Registreerimise kuupäev: 30.01.2004
- (21) Taotluse number: D200300132
- (22) Esitamise kuupäev: 28.11.2003
- (24) Registreeringu kehtivuse alguse kuupäev: 28.11.2003
- (28) Variantide arv: 1
- (30) Prioriteediandmed: M20030163, 28.05.2003, FI
- (72) Autor: Rudy Widiaman, 21848 Providencia St., Woodland Hills, CA 91364, US
- (73) Omanik: Nokia Corporation, Keilalahdentie 4, FIN-02150 Espoo, FI
- (74) Patendivolinik või ühine esindaja: Kaie Puur

(54) Nimetus: **Käsitelefoni klaviatuur**

(55) Reproduksioon:

00886-01

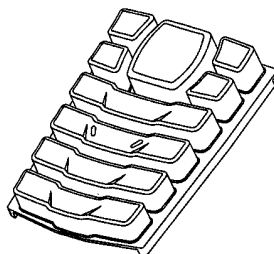
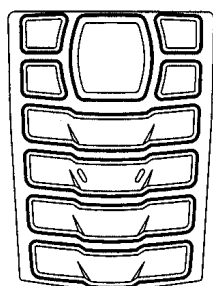

- (11) Registreeringu number: **00887** (51) Klass: **14-03**
- (15) Registreerimise kuupäev: 30.01.2004
- (21) Taotluse number: D200300133
- (22) Esitamise kuupäev: 28.11.2003
- (24) Registreeringu kehtivuse alguse kuupäev: 28.11.2003
- (28) Variantide arv: 1
- (30) Prioriteediandmed: M20030163, 28.05.2003, FI
- (72) Autor: Rudy Widiaman, 21848 Providencia St., Woodland Hills, CA 91364, US
- (73) Omanik: Nokia Corporation, Keilalahdentie 4, FIN-02150 Espoo, FI
- (74) Patendivolinik või ühine esindaja: Kaie Puur

(54) Nimetus: **Käsitelefoni tagapaneel**

(55) Reproduksioon:

00887-01

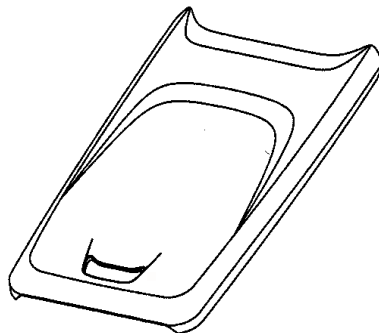
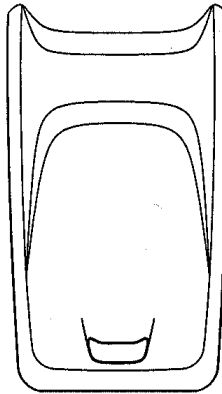

- (11) Registreeringu number: **00888** (51) Klass: **14-03**
- (15) Registreerimise kuupäev: 30.01.2004
- (21) Taotluse number: D200300134
- (22) Esitamise kuupäev: 28.11.2003
- (24) Registreeringu kehtivuse alguse kuupäev: 28.11.2003
- (28) Variantide arv: 1
- (30) Prioriteediandmed: M20030164, 28.05.2003, FI
- (72) Autor: Rudy Widiaman, 21848 Providencia St., Woodland Hills, CA 91364, US
Duncan Burns, #203 18645 Hatteras St., Tarzana, CA 91356, US
- (73) Omanik: Nokia Corporation, Keilalahdentie 4, FIN-02150 Espoo, FI
- (74) Patendivolinik või ühine esindaja: Kaie Puur

(54) Nimetus: **Käsitelefoni klaviatuur**

(55) Reproduksioon:

00888-01

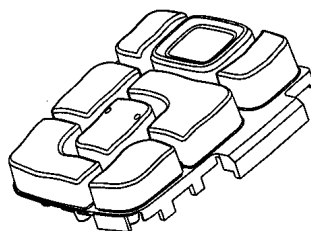
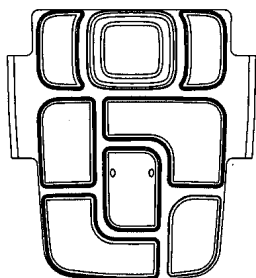

- (11) Registreeringu number: **00889**
- (15) Registreerimise kuupäev: 30.01.2004
- (21) Taotluse number: D200300135
- (22) Esitamise kuupäev: 28.11.2003
- (24) Registreeringu kehtivuse alguse kuupäev: 28.11.2003
- (28) Variantide arv: 1
- (30) Prioriteediandmed: M20030163, 28.05.2003, FI
- (72) Autor: Rudy Widiaman, 21848 Providencia St., Woodland Hills, CA 91364, US
- (73) Omanik: Nokia Corporation, Keilalahdentie 4, FIN-02150 Espoo, FI
- (74) Patendivolinik või ühine esindaja: Kaie Puur

(51) Klass: 14-03

(54) Nimetus: **Käsitelefon**

(55) Reproduksioon:

00889-01

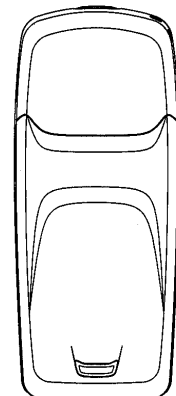
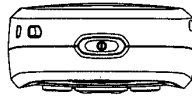
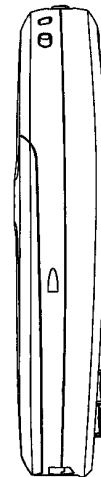
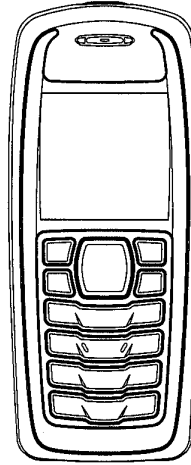
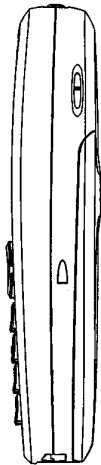
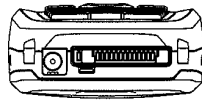

(11) Registreeringu number: **00890**

(51) Klass: **14-03**

(15) Registreerimise kuupäev: 30.01.2004

(21) Taotluse number: D200300136

(22) Esitamise kuupäev: 28.11.2003

(24) Registreeringu kehtivuse
alguse kuupäev: 28.11.2003

(28) Variantide arv: 1

(30) Prioriteediandmed: M20030163, 28.05.2003, FI

(72) Autor: Rudy Widiaman, 21848 Providencia St., Woodland Hills, CA 91364, US

(73) Omanik: Nokia Corporation, Keilalahdentie 4, FIN-02150 Espoo, FI

(74) Patendivolinik või ühine esindaja: Kaie Puur

(54) Nimetus: **Käsitelefoni esipaneel**

(55) Reproduksioon:

00890-01

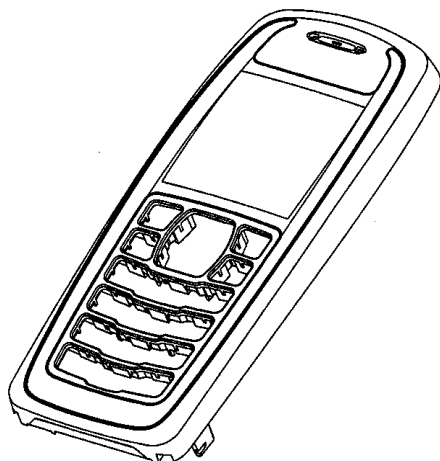
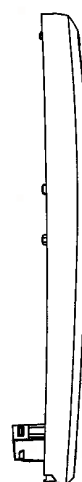
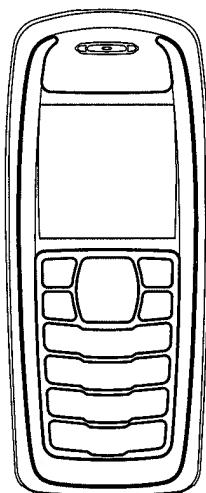

- (11) Registreeringu number: **00891** (51) Klass: **14-03**
- (15) Registreerimise kuupäev: 30.01.2004
- (21) Taotluse number: D200300137
- (22) Esitamise kuupäev: 28.11.2003
- (24) Registreeringu kehtivuse alguse kuupäev: 28.11.2003
- (28) Variantide arv: 1
- (30) Prioriteediandmed: M20030164, 28.05.2003, FI
- (72) Autor: Rudy Widiaman, 21848 Providencia St., Woodland Hills, CA 91364, US
Duncan Burns, #203 18645 Hatteras St., Tarzana, CA 91356, US
- (73) Omanik: Nokia Corporation, Keilalahdentie 4, FIN-02150 Espoo, FI
- (74) Patendivolinik või ühine esindaja: Kaie Puur

(54) Nimetus: **Käsitelefoni esipaneel**

(55) Reproduktsoon:

00891-01

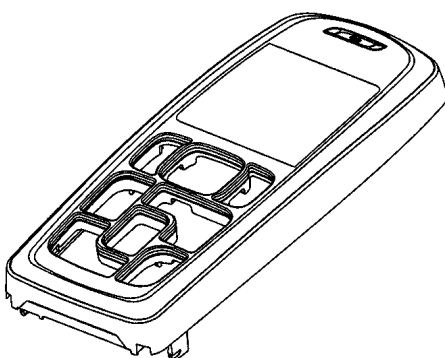
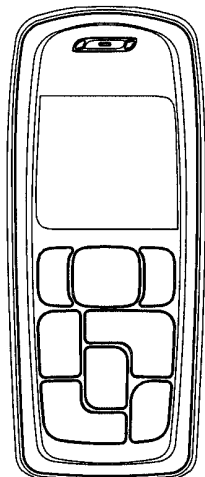
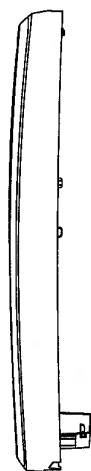

- (11) Registreeringu number: **00892**
- (15) Registreerimise kuupäev: 30.01.2004
- (21) Taotluse number: D200300138
- (22) Esitamise kuupäev: 28.11.2003
- (24) Registreeringu kehtivuse alguse kuupäev: 28.11.2003
- (28) Variantide arv: 1
- (30) Prioriteediandmed: M20030164, 28.05.2003, FI
- (72) Autor: Rudy Widiaman, 21848 Providencia St., Woodland Hills, CA 91364, US
Duncan Burns, #203 18645 Hatteras St., Tarzana, CA 91356, US
- (73) Omanik: Nokia Corporation, Keilalahdentie 4, FIN-02150 Espoo, FI
- (74) Patendivolinik või ühine esindaja: Kaie Puur

(51) Klass: **14-03**

(54) Nimetus: **Käsitelefon**

(55) Reproduksioon:

00892-01

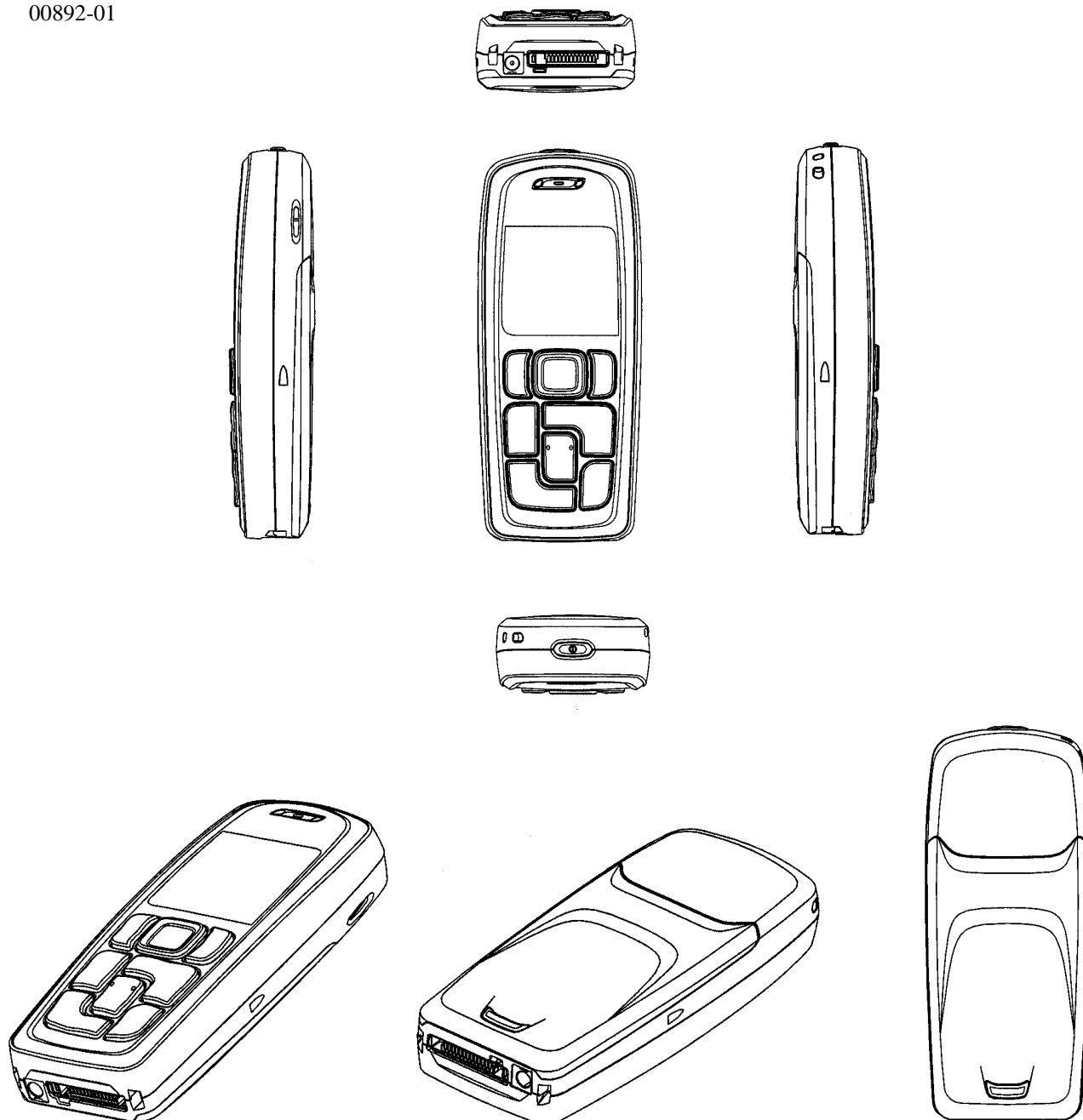

- (11) Registreeringu number: **00893**
- (15) Registreerimise kuupäev: 05.02.2004
- (21) Taotluse number: D200300141
- (22) Esitamise kuupäev: 04.12.2003
- (24) Registreeringu kehtivuse alguse kuupäev: 04.12.2003
- (28) Variantide arv: 1
- (30) Prioriteediandmed: M20030168, 04.06.2003, FI
- (72) Autor: Marianne Thomsen, Halls Alle 13 4tv, 1802 Frederiksberg C, DK
- (73) Omanik: Nokia Corporation, Keilalahdentie 4, FIN-02150 Espoo, FI
- (74) Patendivolinik või ühine esindaja: Aivo Arula

(51) Klass: 14-03

(54) Nimetus: **Käsitelefon**

(55) Reproduksioon:

00893-01

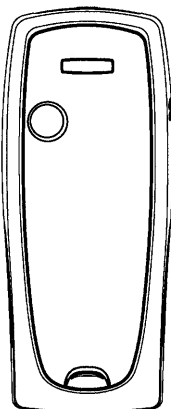
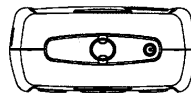
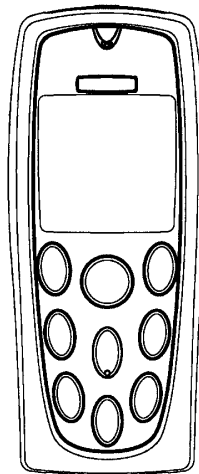
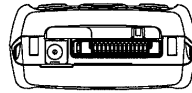

(11) Registreeringu number: **00894**

(51) Klass: **14-03**

(15) Registreerimise kuupäev: 05.02.2004

(21) Taotluse number: D200300142

(22) Esitamise kuupäev: 04.12.2003

(24) Registreeringu kehtivuse
alguse kuupäev: 04.12.2003

(28) Variantide arv: 1

(30) Prioriteediandmed: M20030168, 04.06.2003, FI

(72) Autor: Marianne Thomsen, Halls Alle 13 4tv, 1802 Frederiksberg C, DK

(73) Omanik: Nokia Corporation, Keilalahdentie 4, FIN-02150 Espoo, FI

(74) Patendivolinik või ühine esindaja: Aivo Arula

(54) Nimetus: **Käsitelefoni esipaneel**

(55) Reproduksioon:

00894-01

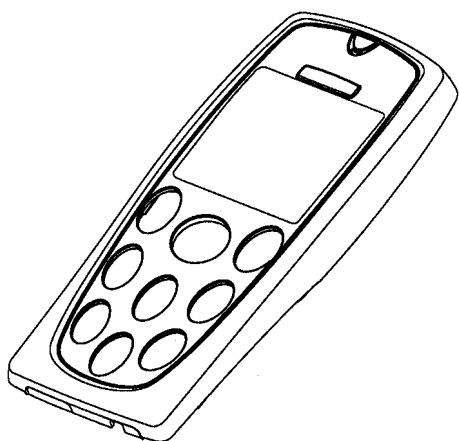
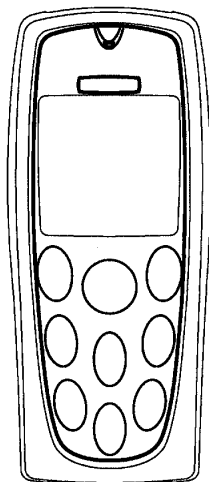
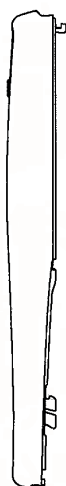

- (11) Registreeringu number: **00895**
- (15) Registreerimise kuupäev: 05.02.2004
- (21) Taotluse number: D200300143
- (22) Esitamise kuupäev: 04.12.2003
- (24) Registreeringu kehtivuse alguse kuupäev: 04.12.2003
- (28) Variantide arv: 1
- (30) Prioriteediandmed: M20030168, 04.06.2003, FI
- (72) Autor: Marianne Thomsen, Halls Alle 13 4tv, 1802 Frederiksberg C, DK
- (73) Omanik: Nokia Corporation, Keilalahdentie 4, FIN-02150 Espoo, FI
- (74) Patendivolinik või ühine esindaja: Aivo Arula

(51) Klass: **14-03**(54) Nimetus: **Käsitelefoni tagapaneel**

(55) Reproduksioon:

00895-01

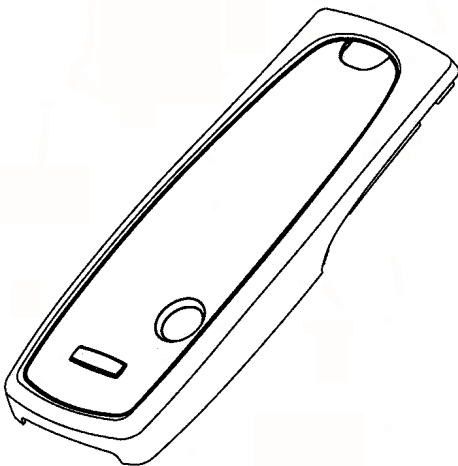
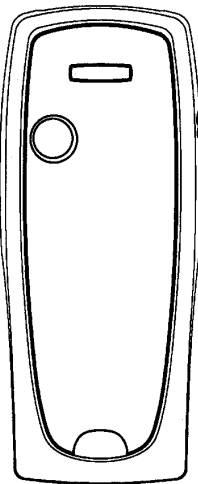

- (11) Registreeringu number: **00896** (51) Klass: **14-03**
- (15) Registreerimise kuupäev: 05.02.2004
- (21) Taotluse number: D200300144
- (22) Esitamise kuupäev: 04.12.2003
- (24) Registreeringu kehtivuse alguse kuupäev: 04.12.2003
- (28) Variantide arv: 1
- (30) Prioriteediandmed: M20030168, 04.06.2003, FI
- (72) Autor: Marianne Thomsen, Halls Alle 13 4tv, 1802 Frederiksberg C, DK
- (73) Omanik: Nokia Corporation, Keilalahdentie 4, FIN-02150 Espoo, FI
- (74) Patendivolinik või ühine esindaja: Aivo Arula

(54) Nimetus: **Käsitelefoni klaviatuur**

(55) Reproduktsoon:

00896-01

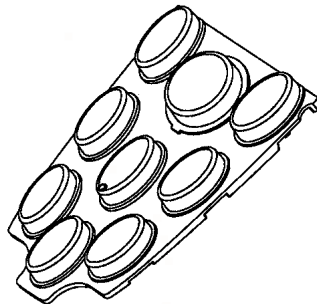
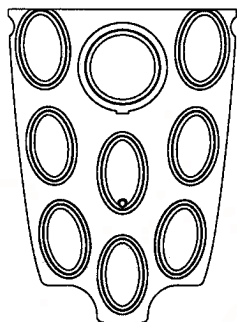

- (11) Registreeringu number: **00897** (51) Klass: **14-01, 14-03**
- (15) Registreerimise kuupäev: 05.02.2004
- (21) Taotluse number: D200300145
- (22) Esitamise kuupäev: 15.12.2003
- (24) Registreeringu kehtivuse alguse kuupäev: 15.12.2003
- (28) Variantide arv: 1
- (30) Prioriteediandmed: M20030170, 13.06.2003, FI
- (72) Autor: Valtteri Eroma, Valopoiju 2 A 27, 02320 Espoo, FI
Sami Lehtovaara, Suovasentie 52, 21250 Masku, FI
Nokia Corporation, Keilalahdentie 4, FIN-02150 Espoo, FI
- (73) Omanik: Nokia Corporation, Keilalahdentie 4, FIN-02150 Espoo, FI
- (74) Patendivolinik või ühine esindaja: Kaie Puur

(54) Nimetus: **Peakomplekt**

(55) Reproduktsoon:

00897-01



- (11) Registreeringu number: **00898** (51) Klass: **16-01**
- (15) Registreerimise kuupäev: 05.02.2004
- (21) Taotluse number: D200300146
- (22) Esitamise kuupäev: 15.12.2003
- (24) Registreeringu kehtivuse alguse kuupäev: 15.12.2003
- (28) Variantide arv: 1
- (30) Prioriteediandmed: 29/183,520, 13.06.2003, US
- (72) Autor: Valtteri Eroma, Valopoiju 2 A 27, 02320 Espoo, FI
John-Rhys Newman, 6126 Coral Pink Circle, Woodland Hills, CA 91302, US
- (73) Omanik: Nokia Corporation, Keilalahdentie 4, FIN-02150 Espoo, FI
- (74) Patendivolinik või ühine esindaja: Kaie Puur

(54) Nimetus: **Kaamera**

(55) Reproduktsoon:

00898-01



- (11) Registreeringu number: **00899** (51) Klass: **14-03**
- (15) Registreerimise kuupäev: 05.02.2004
- (21) Taotluse number: D200300147
- (22) Esitamise kuupäev: 15.12.2003
- (24) Registreeringu kehtivuse alguse kuupäev: 15.12.2003
- (28) Variantide arv: 1
- (30) Prioriteediandmed: 29/183,524, 13.06.2003, US
- (72) Autor: Junichi Kagami, 4-26-7, Akatsutsumi, Setagaya-ku, 156-004 Tokyo, JP
Todd Wood, 1544 12th Street #202, Santa Monica, CA 90401, US
Paresh Desai, 13900 Panay Way #M220, Marina del Rey, CA 90292, US
Robert Shepherd, 5830 Reseda BI, #143, Tarzana, CA 91356, US
- (73) Omanik: Nokia Corporation, Keilalahdentie 4, FIN-02150 Espoo, FI
- (74) Patendivolinik või ühine esindaja: Kaie Puur

(54) Nimetus: **Käsitelefon**

(55) Reproduktsoon:

00899-01

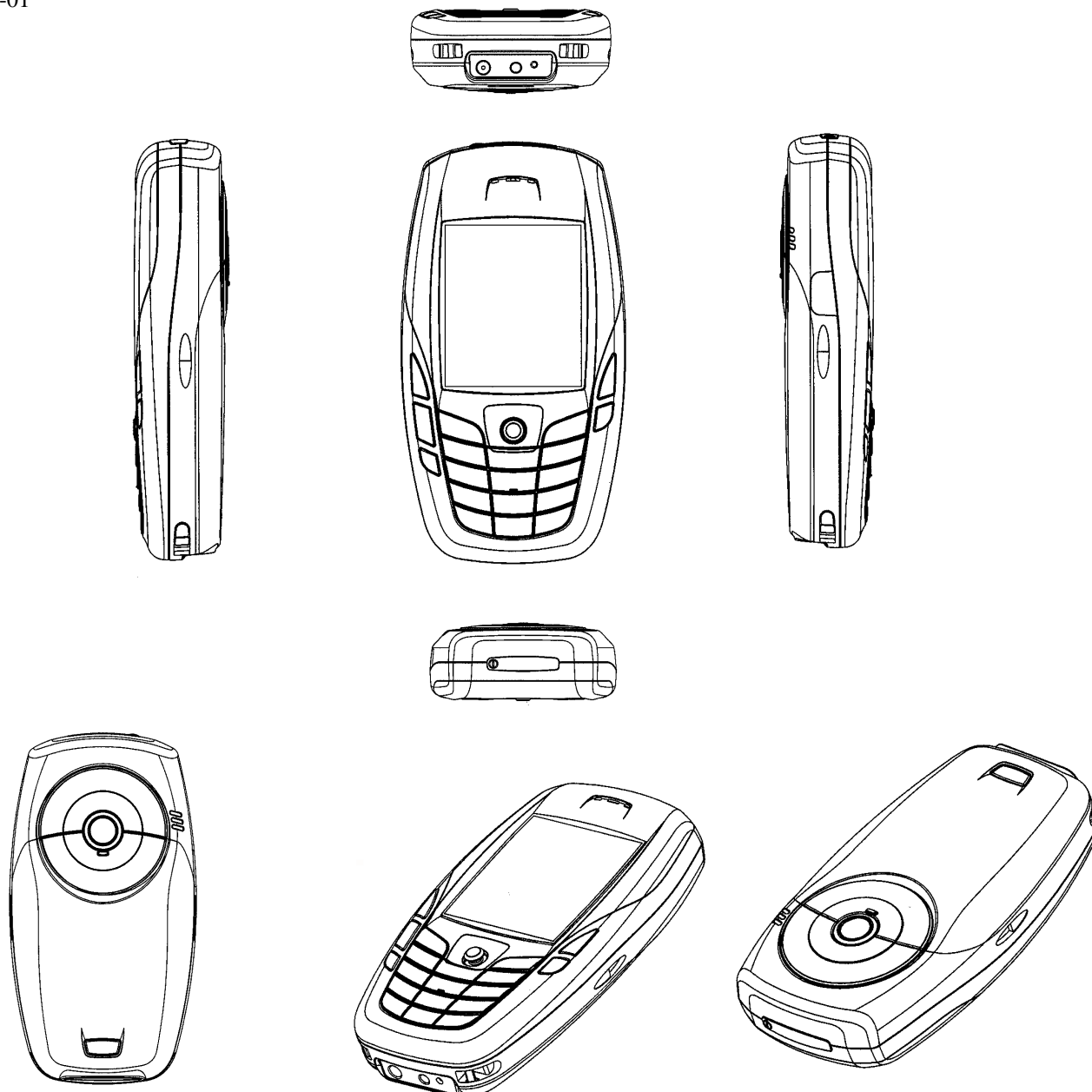

- (11) Registreeringu number: **00900** (51) Klass: **14-03**
- (15) Registreerimise kuupäev: 12.02.2004
- (21) Taotluse number: D200300109
- (22) Esitamise kuupäev: 01.10.2003
- (24) Registreeringu kehtivuse alguse kuupäev: 01.10.2003
- (28) Variantide arv: 1
- (30) Prioriteediandmed: 29/178,730, 01.04.2003, US
- (72) Autor: Frank Nuovo, 1612 Stradella Road, Los Angeles, CA 90077, US
Justin Lyles, 4470 Ventura Canyon Ave Apt F 107, Sherman Oaks, CA 91423, US
- (73) Omanik: Vertu Ltd, 51 Eastcheap, London EC3M 1JP, GB
- (74) Patendivolinik või ühine esindaja: Kaie Puur

(54) Nimetus: **Käsitelefoni esipaneel**

(55) Reproduktsioon:

00900-01

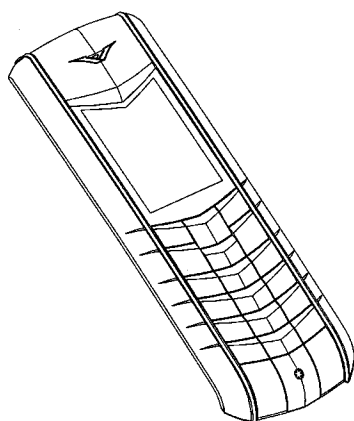
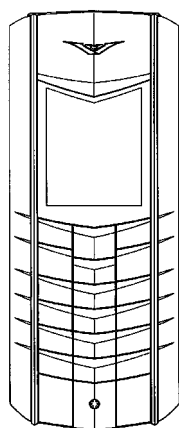

- (11) Registreeringu number: **00901** (51) Klass: **14-03**
- (15) Registreerimise kuupäev: 12.02.2004
- (21) Taotluse number: D200300110
- (22) Esitamise kuupäev: 01.10.2003
- (24) Registreeringu kehtivuse alguse kuupäev: 01.10.2003
- (28) Variantide arv: 1
- (30) Prioriteediandmed: 29/178,730, 01.04.2003, US
- (72) Autor: Frank Nuovo, 1612 Stradella Road, Los Angeles, CA 90077, US
Justin Lyles, 4470 Ventura Canyon Ave Apt F 107, Sherman Oaks, CA 91423, US
- (73) Omanik: Vertu Ltd, 51 Eastcheap, London EC3M 1JP, GB
- (74) Patendivolinik või ühine esindaja: Kaie Puur

(54) Nimetus: **Käsitelefon**

(55) Reproduktsoon:

00901-01

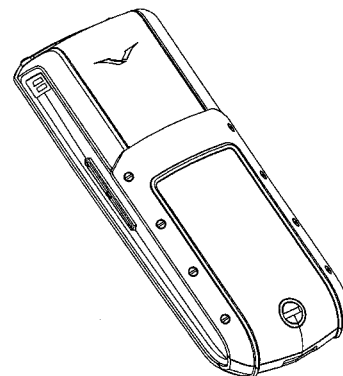
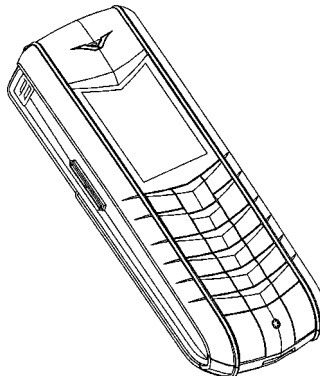
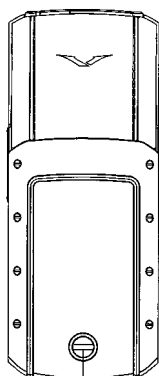
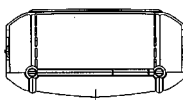
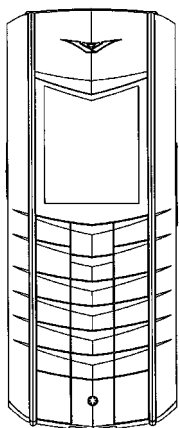
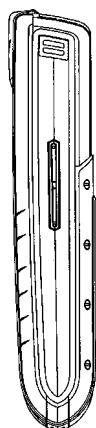
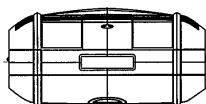

(11) Registreeringu number: **00902**

(51) Klass: **20-03**

(15) Registreerimise kuupäev: 12.02.2004

(21) Taotluse number: D200300149

(22) Esitamise kuupäev: 22.12.2003

(24) Registreeringu kehtivuse
alguse kuupäev: 22.12.2003

(28) Variantide arv: 2

(72) Autor: Franklin D. McMahon, Tartu mnt 18, 10115 Tallinn, EE

(73) Omanik: UNICOM EESTI OÜ, Tartu mnt 18, 10115 Tallinn, EE

(74) Patendivolinik või ühine esindaja: Ott Moorlat

(54) Nimetus: **Linnasammas**

(55) Reproduktsoon:

00902-01

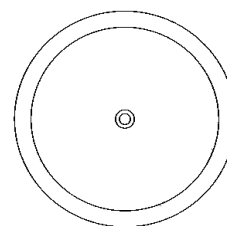
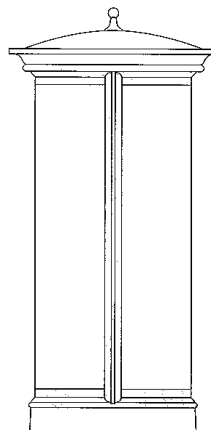
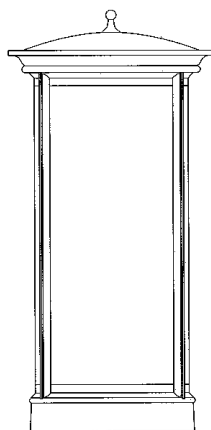
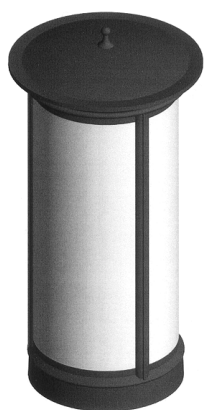

00902-02

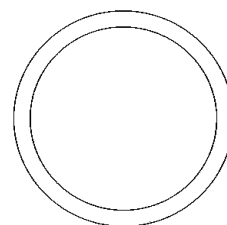
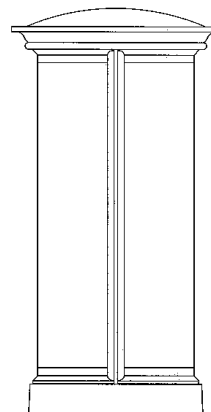
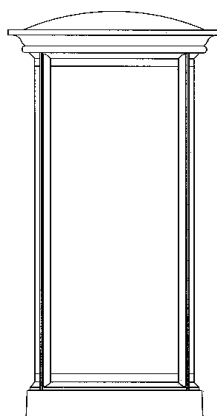
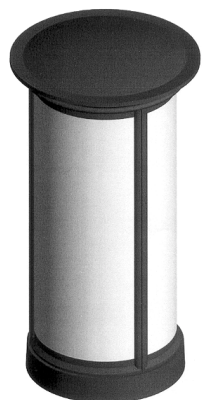

(11) Registreeringu number: **00903**

(51) Klass: **20-03**

(15) Registreerimise kuupäev: 12.02.2004

(21) Taotluse number: D200300150

(22) Esitamise kuupäev: 22.12.2003

(24) Registreeringu kehtivuse
alguse kuupäev: 22.12.2003

(28) Variantide arv: 1

(72) Autor: Franklin D. McMahon, Tartu mnt 18, 10115 Tallinn, EE

(73) Omanik: UNICOM EESTI OÜ, Tartu mnt 18, 10115 Tallinn, EE

(74) Patendivolinik või ühine esindaja: Ott Moorlat

(54) Nimetus: **Linnasammas**

(55) Reproduktsoon:

00903-01

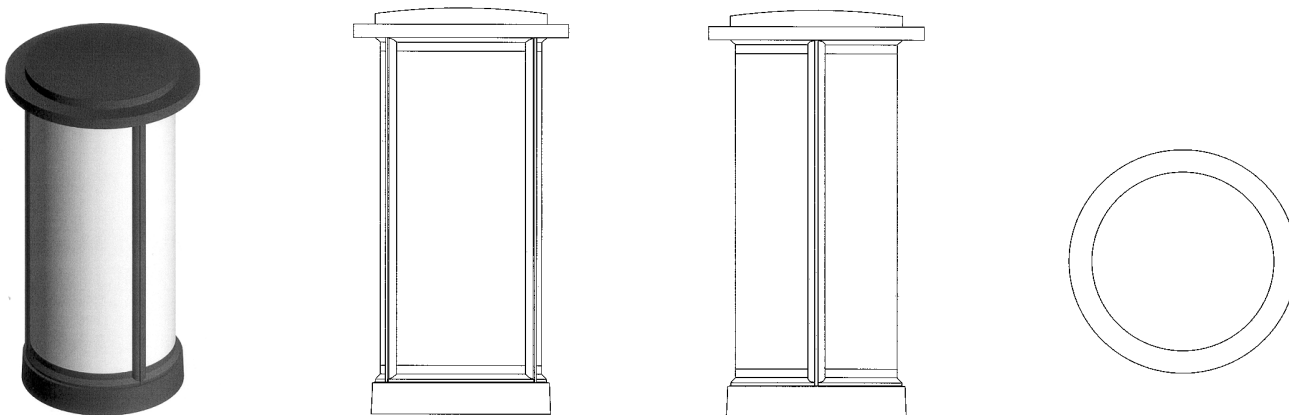

(11) Registreeringu number: **00904**

(51) Klass: **09-07**

(15) Registreerimise kuupäev: 12.02.2004

(21) Taotluse number: D200300151

(22) Esitamise kuupäev: 22.12.2003

(24) Registreeringu kehtivuse
alguse kuupäev: 22.12.2003

(28) Variantide arv: 1

(72) Autor: Blanca Ros, Provenza 398, 02025 Barcelona, ES

(73) Omanik: PEPSICO, INC., 700 Anderson Hill Road, Purchase, NY 10577-1444, US

(74) Patendivolinik või ühine esindaja: Olga Treufeldt

(54) Nimetus: **Pudelikork**

(55) Reproduktsoon:

00904-01

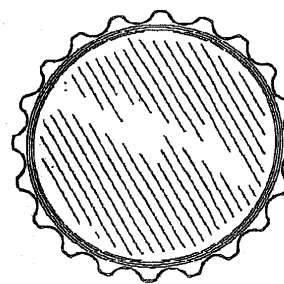
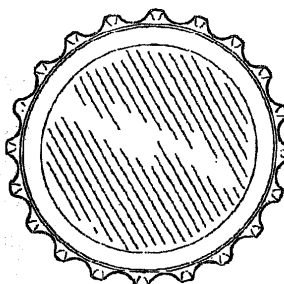
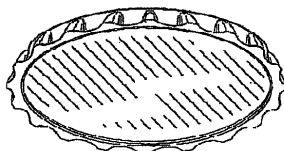
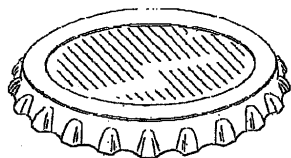

- (11) Registreeringu number: **00905**
- (15) Registreerimise kuupäev: 12.02.2004
- (21) Taotluse number: D200300152
- (22) Esitamise kuupäev: 29.12.2003
- (24) Registreeringu kehtivuse alguse kuupäev: 29.12.2003
- (28) Variantide arv: 2
- (72) Autor: Arne Luhalaid, Laki 5, 10621 Tallinn, EE
Pearn Lehis, Laki 5, 10621 Tallinn, EE
AS Tehnoplast, Laki 5, 10621 Tallinn, EE
- (73) Omanik: AS Tehnoplast, Laki 5, 10621 Tallinn, EE
- (74) Patendivolinik või ühine esindaja: Ott Moorlat

(51) Klass: **09-01**

(54) Nimetus: **Pudel**

(55) Reproduktsoon:

00905-01



00905-02

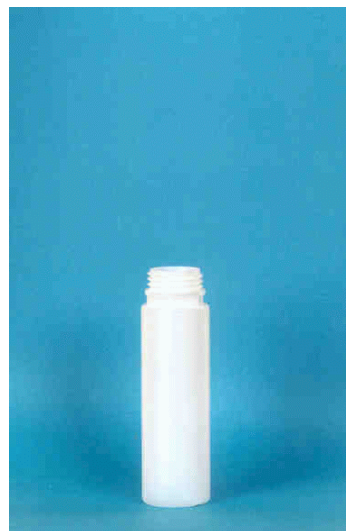

(11) Registreeringu number: **00906**

(51) Klass: **09-01**

(15) Registreerimise kuupäev: 12.02.2004

(21) Taotluse number: D200300153

(22) Esitamise kuupäev: 29.12.2003

(24) Registreeringu kehtivuse alguse kuupäev: 29.12.2003

(28) Variantide arv: 2

(72) Autor: Peeter Remmel, Laki 5, 10621 Tallinn, EE

Pearn Lehis, Laki 5, 10621 Tallinn, EE

(73) Omanik: AS Tehnoplast, Laki 5, 10621 Tallinn, EE

(74) Patendivolinik või ühine esindaja: Ott Moorlat

(54) Nimetus: **Pudel**

(55) Reproduktsoon:

00906-01



00906-02



(11) Registreeringu number: **00907**

(51) Klass: **09-01**

(15) Registreerimise kuupäev: 12.02.2004

(21) Taotluse number: D200300154

(22) Esitamise kuupäev: 29.12.2003

(24) Registreeringu kehtivuse
alguse kuupäev: 29.12.2003

(28) Variantide arv: 2

(72) Autor: Peeter Remmel, Laki 5, 10621 Tallinn, EE

Pearn Lehis, Laki 5, 10621 Tallinn, EE

(73) Omanik: AS Tehnoplast, Laki 5, 10621 Tallinn, EE

(74) Patendivolinik või ühine esindaja: Ott Moorlat

(54) Nimetus: **Pudel**

(55) Reproduktsoon:

00907-01



00907-02



(11) Registreeringu number: **00908**

(51) Klass: **20-03**

(15) Registreerimise kuupäev: 12.02.2004

(21) Taotluse number: D200300155

(22) Esitamise kuupäev: 30.12.2003

(24) Registreeringu kehtivuse
alguse kuupäev: 30.12.2003

(28) Variantide arv: 3

(72) Autor: Franklin D. McMahon, Tartu mnt 18, 10115 Tallinn, EE

(73) Omanik: UNICOM EESTI OÜ, Tartu mnt 18, 10115 Tallinn, EE

(74) Patendivolinik või ühine esindaja: Ott Moorlat

(54) Nimetus: **Piilar**

(55) Reproduktsoon:

00908-01

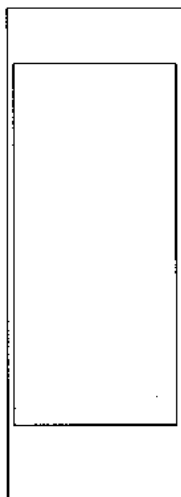
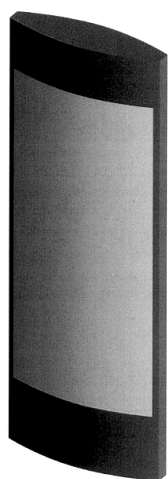

00908-02

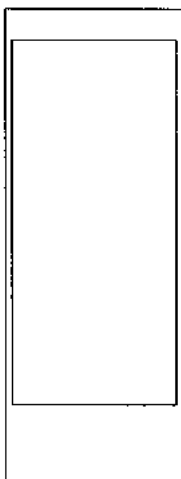
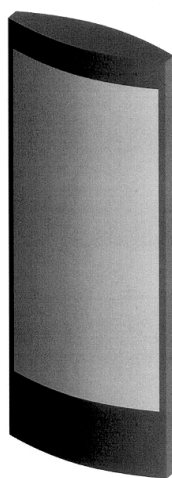

00908-03

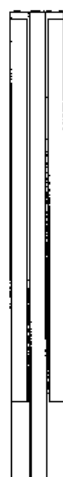
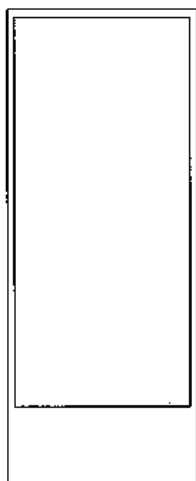
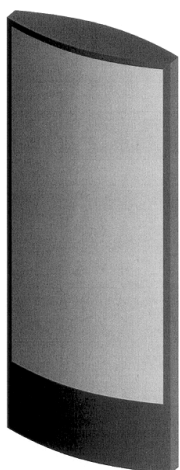

(11) Registreeringu number: **00909**

(51) Klass: **20-03**

(15) Registreerimise kuupäev: 12.02.2004

(21) Taotluse number: D200300156

(22) Esitamise kuupäev: 30.12.2003

(24) Registreeringu kehtivuse
alguse kuupäev: 30.12.2003

(28) Variantide arv: 2

(72) Autor: Franklin D. McMahon, Tartu mnt 18, 10115 Tallinn, EE

(73) Omanik: UNICOM EESTI OÜ, Tartu mnt 18, 10115 Tallinn, EE

(74) Patendivolinik või ühine esindaja: Ott Moorlat

(54) Nimetus: **Reklaamtahvel**

(55) Reproduktsoon:

00909-01

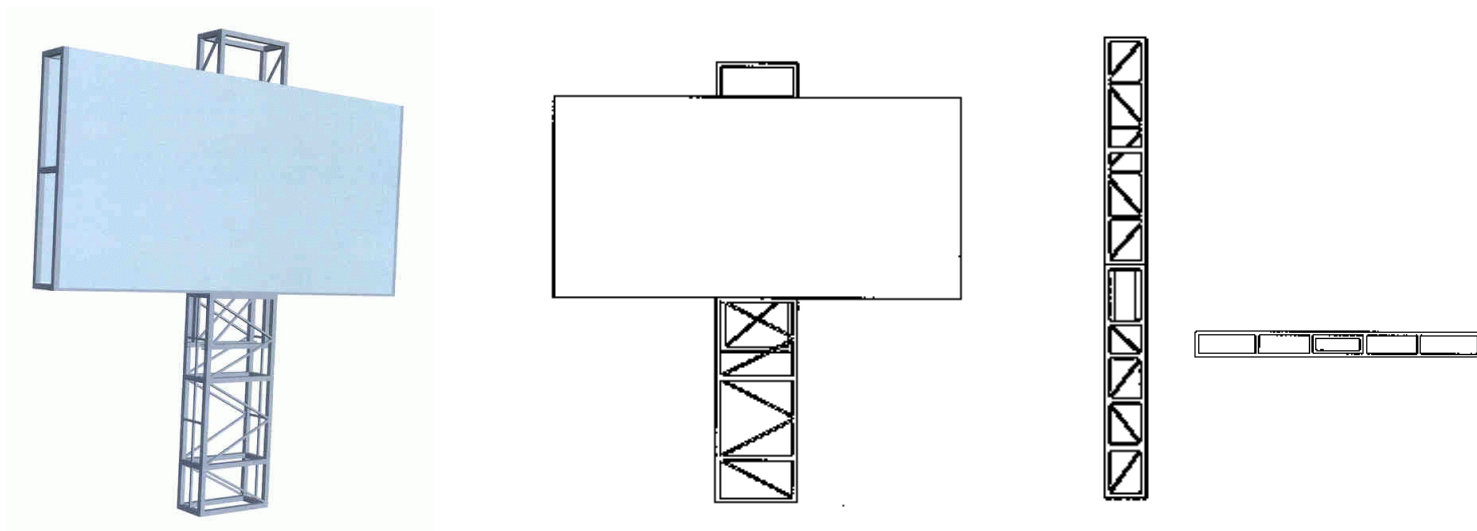

00909-02

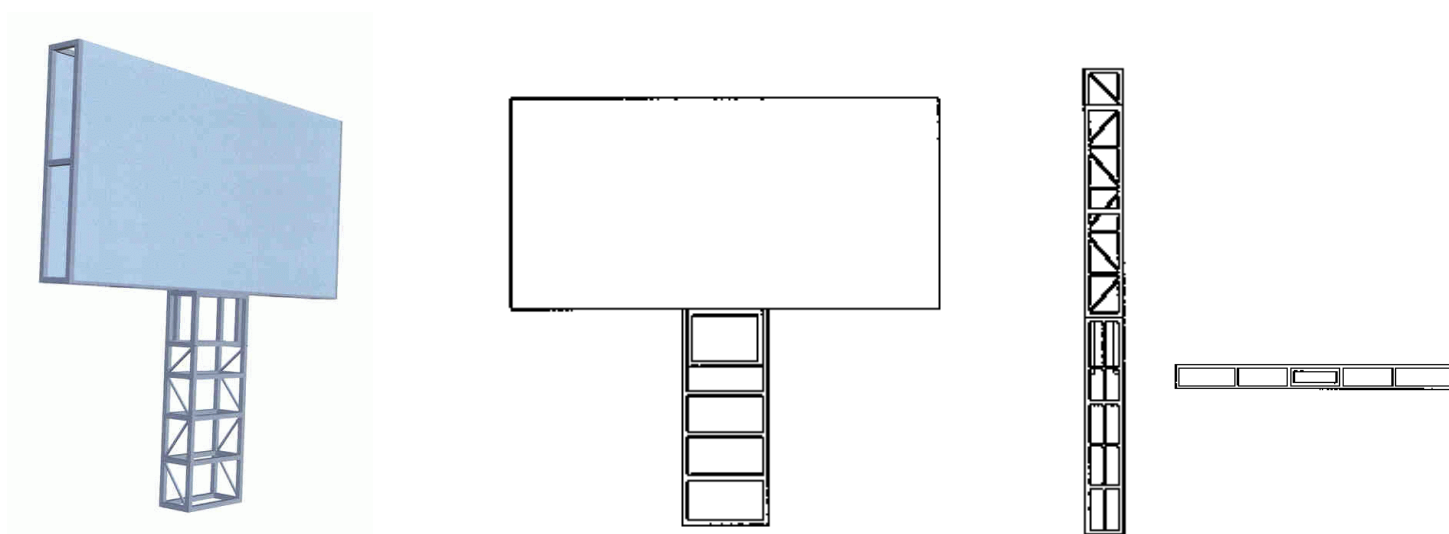

(11) Registreeringu number: **00910**

(51) Klass: **07-02**

(15) Registreerimise kuupäev: 12.02.2004

(21) Taotluse number: D200300157

(22) Esitamise kuupäev: 30.12.2003

(24) Registreeringu kehtivuse
alguse kuupäev: 30.12.2003

(28) Variantide arv: 1

(30) Prioriteediandmed: 48095, 03.07.2003, EM

(72) Autor: Charbel Karam, Svedjegatan, SE-692 38 Kumla, SE

(73) Omanik: Atria Concept AB, SE-697 80 Sköllersta, SE

(74) Patendivolinik või ühine esindaja: Olga Treufeldt

(54) Nimetus: **Hamburgerisoojendi**

(55) Reproduktsoon:

00910-01

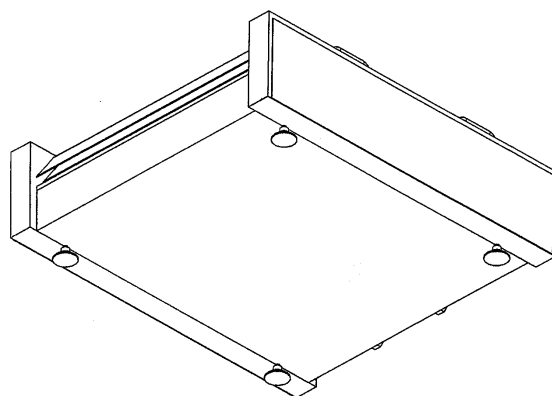
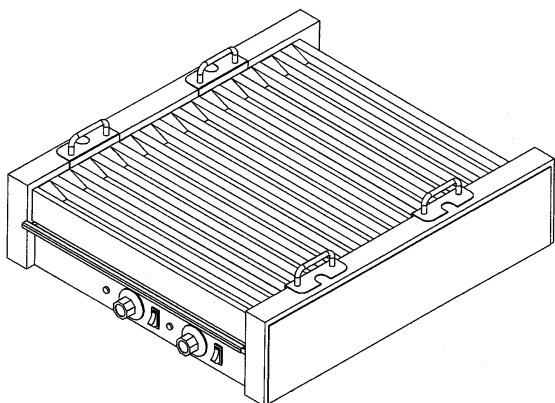

(11) Registreeringu number: **00911**

(51) Klass: **09-01**

(15) Registreerimise kuupäev: 19.02.2004

(21) Taotluse number: D200400002

(22) Esitamise kuupäev: 05.01.2004

(24) Registreeringu kehtivuse
alguse kuupäev: 05.01.2004

(28) Variantide arv: 1

(72) Autor: Karl Heinz Landwehr, Überseering 18, 22297 Hamburg, DE

(73) Omanik: Tchibo Frisch-Röst-Kaffee GmbH, Überseering 18, 22297 Hamburg, DE

(74) Patendivolinik või ühine esindaja: Lembit Mitt

(54) Nimetus: **Purk**

(55) Reproduktsoon:

00911-01



- (11) Registreeringu number: **00912** (51) Klass: **07-05**
- (15) Registreerimise kuupäev: 19.02.2004
- (21) Taotluse number: D200400003
- (22) Esitamise kuupäev: 07.01.2004
- (24) Registreeringu kehtivuse alguse kuupäev: 07.01.2004
- (28) Variantide arv: 1
- (30) Prioriteediandmed: 60793, 04.08.2003, EM
- (72) Autor: Bjorn Weggelaar, Verspronckweg 233, 2023 BH Haarlem, NL
- (73) Omanik: Kiwi European Holdings B.V., Vleutensevaart 100, 3532 AD Utrecht, NL
- (74) Patendivolinik või ühine esindaja: Lembit Mitt

(54) Nimetus: **Kingakreemiaplikaator**

(55) Reproduktsoon:

00912-01

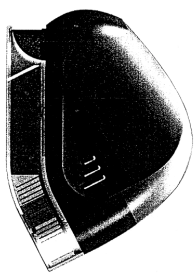
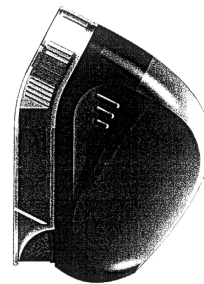
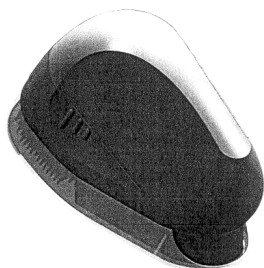

(11) Registreeringu number: **00913**

(51) Klass: **20-03**

(15) Registreerimise kuupäev: 19.02.2004

(21) Taotluse number: D200400005

(22) Esitamise kuupäev: 20.01.2004

(24) Registreeringu kehtivuse
alguse kuupäev: 20.01.2004

(28) Variantide arv: 5

(72) Autor: Franklin D. McMahon, Tartu mnt 18, 10115 Tallinn, EE

(73) Omanik: UNICOM EESTI OÜ, Tartu mnt 18, 10115 Tallinn, EE

(74) Patendivolinik või ühine esindaja: Ott Moorlat

(54) Nimetus: **Valgustatud reklaamtahvel**

(55) Reproduktsoon:

00913-01

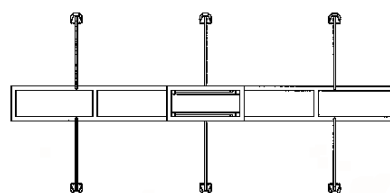
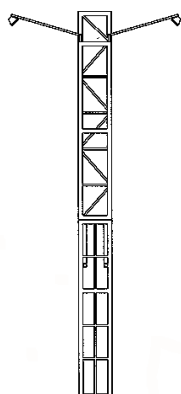
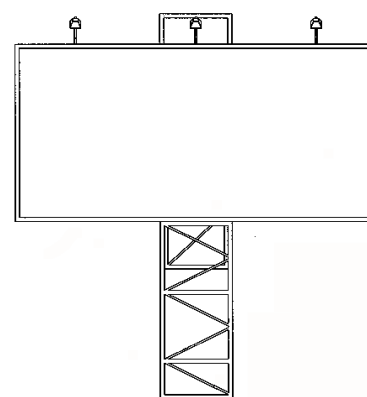
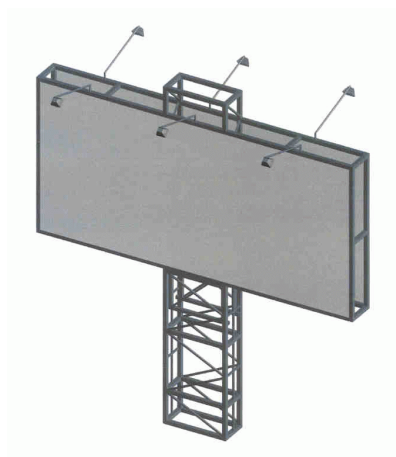

00913-02

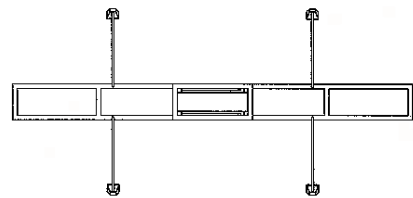
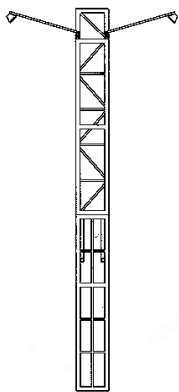
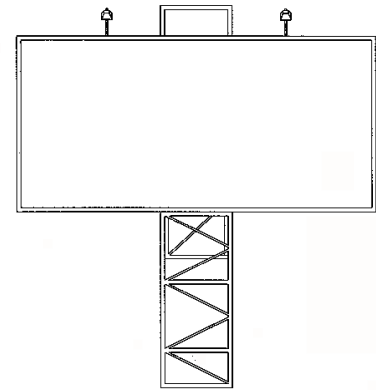
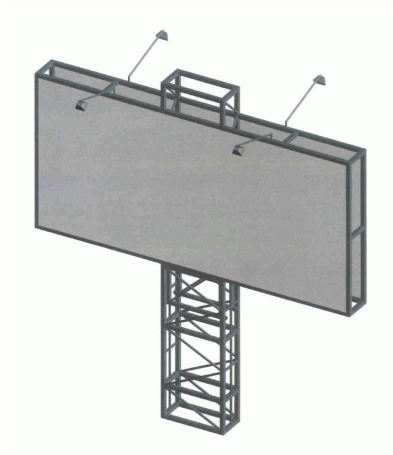

00913-03

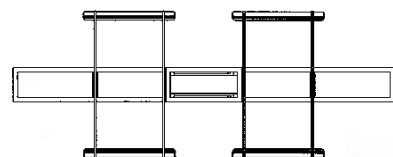
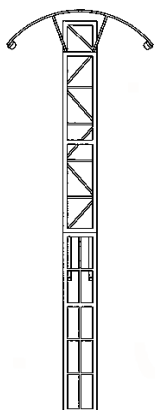
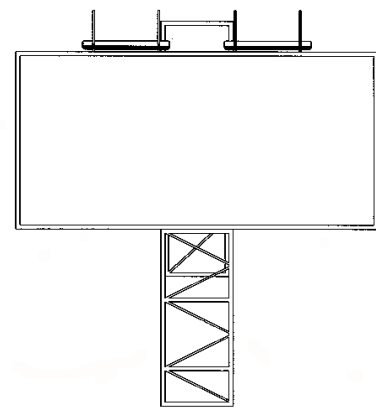
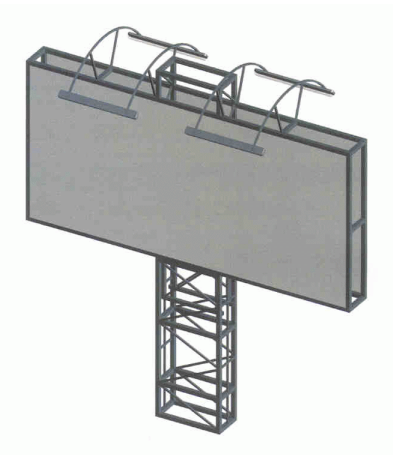

00913-04

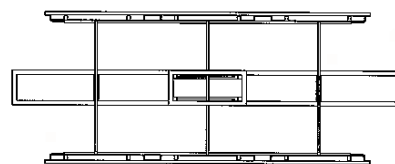
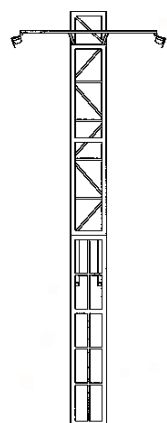
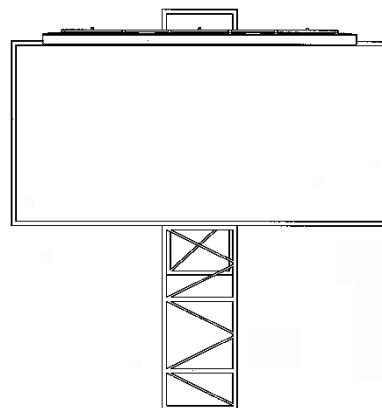

00913-05

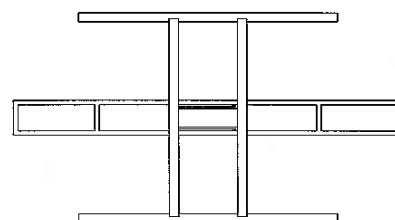
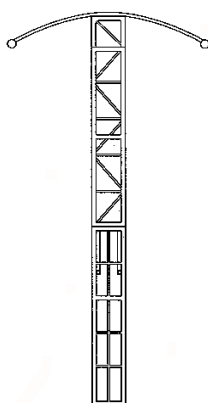
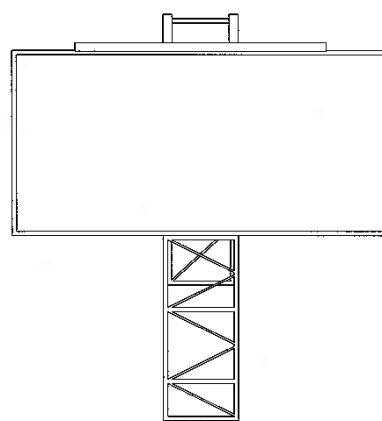
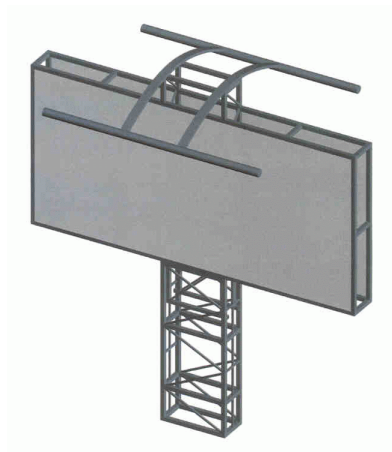

(11) Registreeringu number: **00914**

(51) Klass: **20-03**

(15) Registreerimise kuupäev: 19.02.2004

(21) Taotluse number: D200400006

(22) Esitamise kuupäev: 20.01.2004

(24) Registreeringu kehtivuse
alguse kuupäev: 20.01.2004

(28) Variantide arv: 5

(72) Autor: Franklin D. McMahon, Tartu mnt 18, 10115 Tallinn, EE

(73) Omanik: UNICOM EESTI OÜ, Tartu mnt 18, 10115 Tallinn, EE

(74) Patendivolinik või ühine esindaja: Ott Moorlat

(54) Nimetus: **Valgustatud reklaamtahvel**

(55) Reproduktsoon:

00914-01

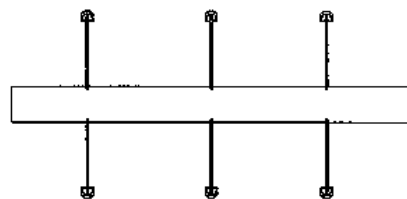
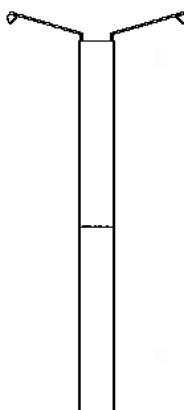
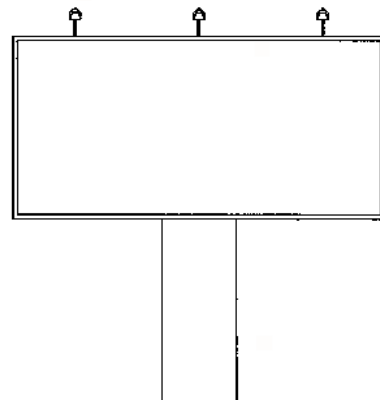

00914-02

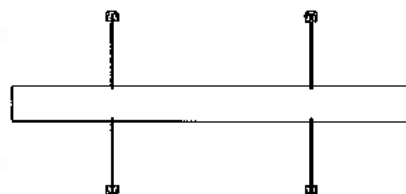
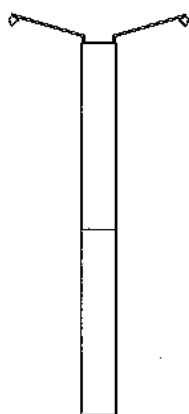
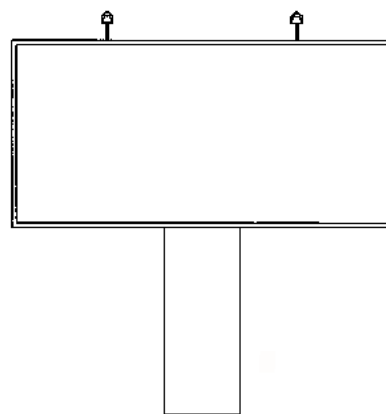

00914-03

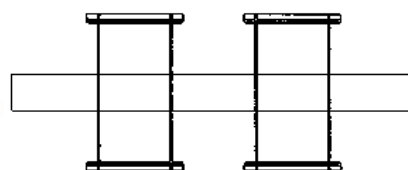
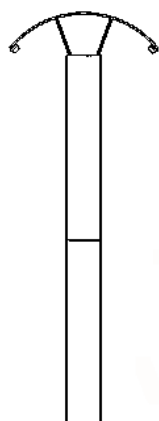
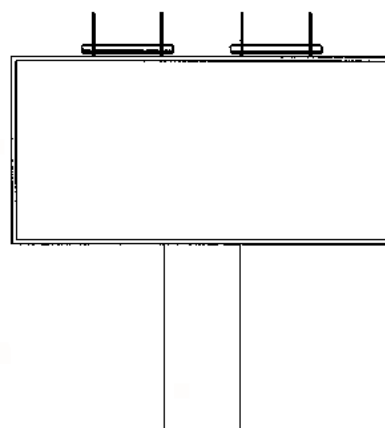
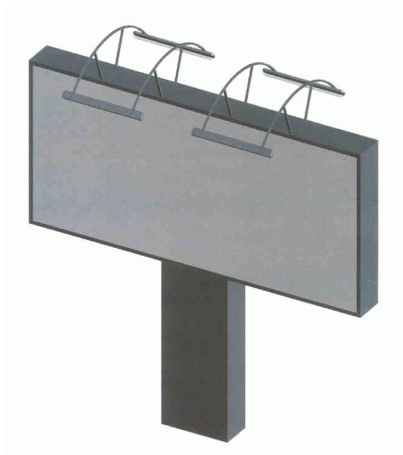

00914-04

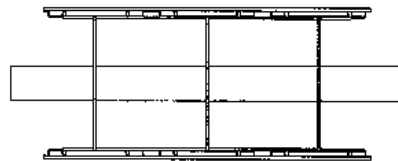
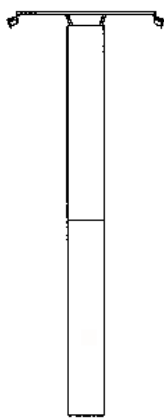
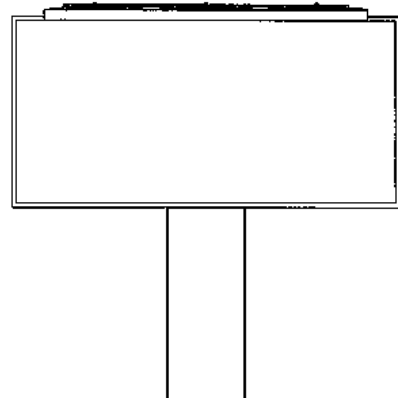

00914-05

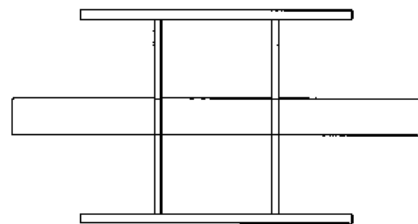
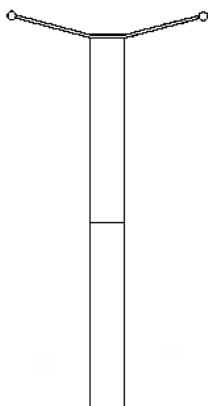
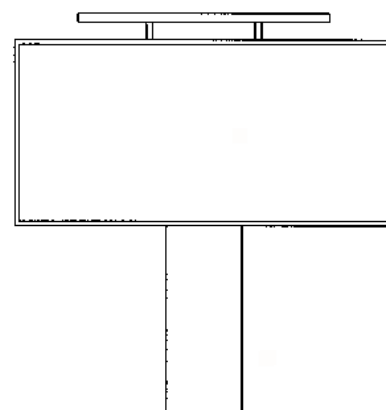

(11) Registreeringu number: **00915**

(51) Klass: **20-03**

(15) Registreerimise kuupäev: 19.02.2004

(21) Taotluse number: D200400007

(22) Esitamise kuupäev: 20.01.2004

(24) Registreeringu kehtivuse alguse kuupäev: 20.01.2004

(28) Variantide arv: 5

(72) Autor: Franklin D. McMahon, Tartu mnt 18, 10115 Tallinn, EE

(73) Omanik: UNICOM EESTI OÜ, Tartu mnt 18, 10115 Tallinn, EE

(74) Patendivolinik või ühine esindaja: Ott Moorlat

(54) Nimetus: **Valgustatud reklaamtahvel**

(55) Reproduktsoon:

00915-01

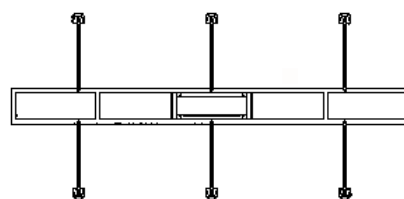
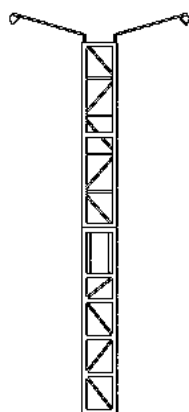
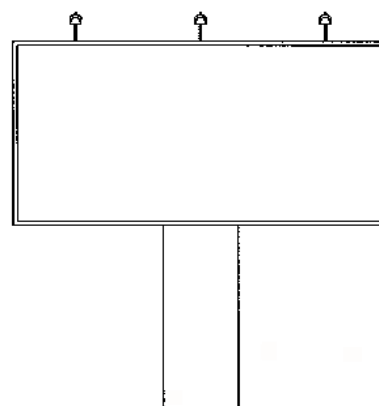
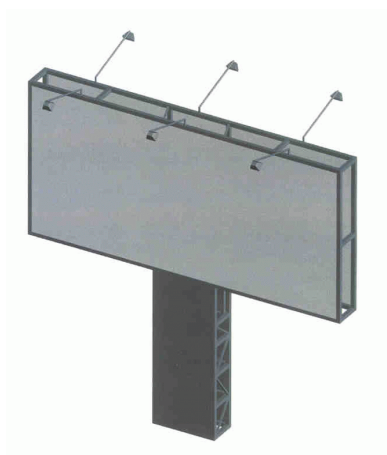

00915-02

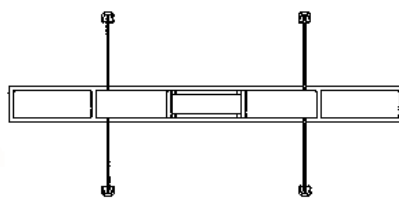
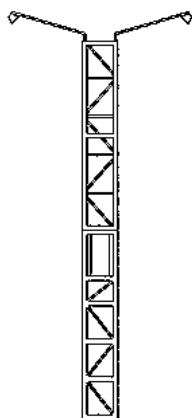
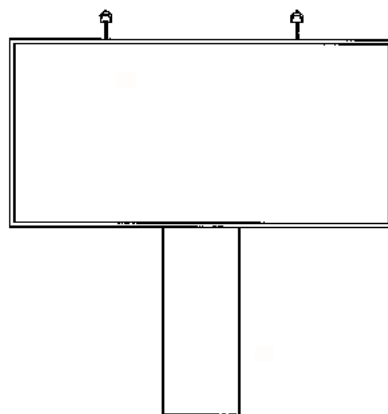
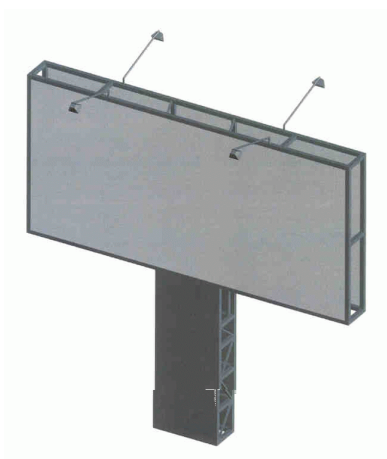

00915-03

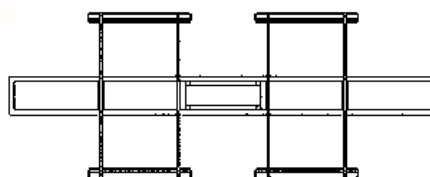
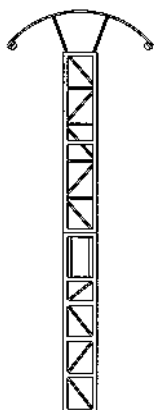
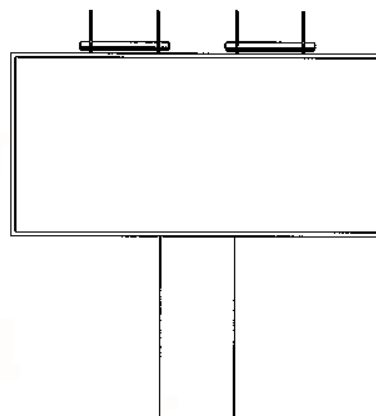

00915-04

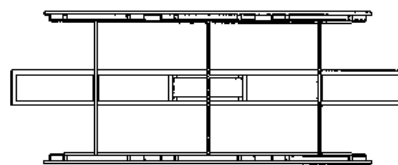
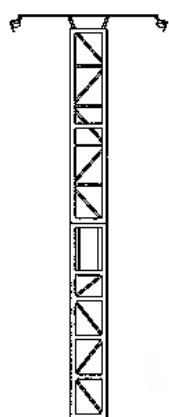
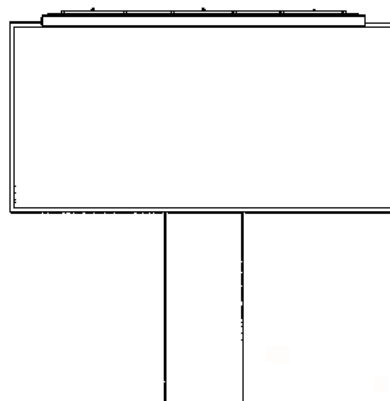
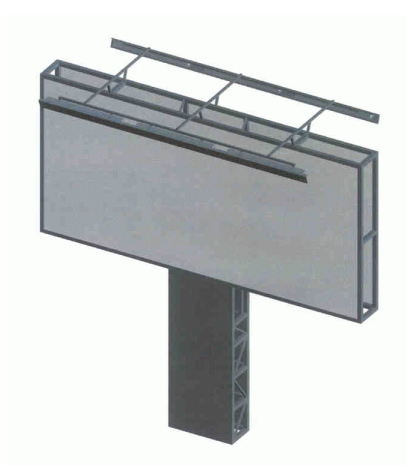

00915-05

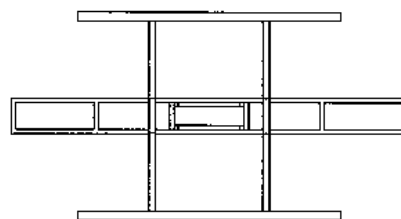
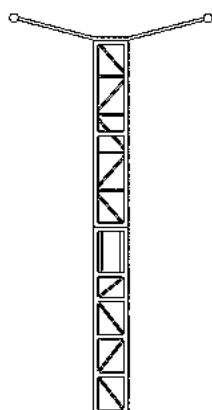
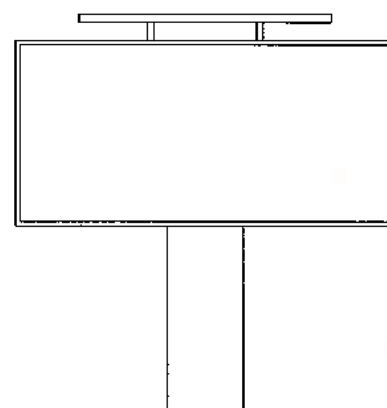

(11) Registreeringu number: **00916**

(51) Klass: **20-03**

(15) Registreerimise kuupäev: 19.02.2004

(21) Taotluse number: D200400008

(22) Esitamise kuupäev: 20.01.2004

(24) Registreeringu kehtivuse
alguse kuupäev: 20.01.2004

(28) Variantide arv: 5

(72) Autor: Franklin D. McMahon, Tartu mnt 18, 10115 Tallinn, EE

(73) Omanik: UNICOM EESTI OÜ, Tartu mnt 18, 10115 Tallinn, EE

(74) Patendivolinik või ühine esindaja: Ott Moorlat

(54) Nimetus: **Valgustatud reklaamtahvel**

(55) Reproduktsoon:

00916-01

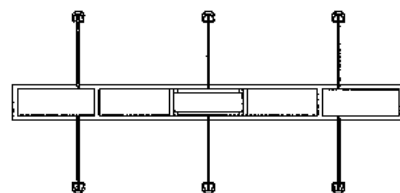
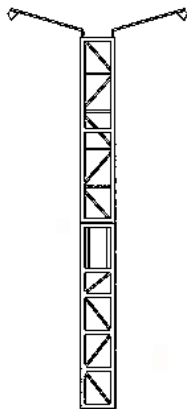
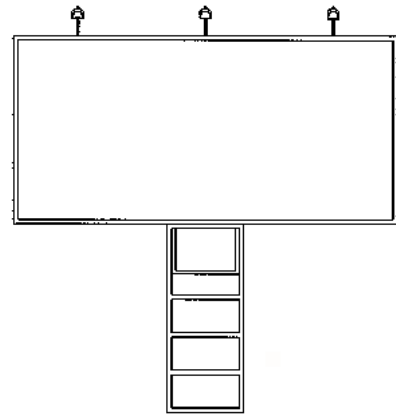
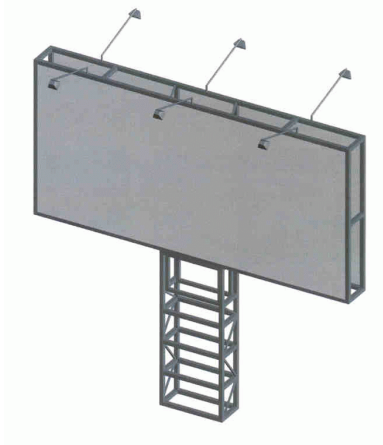

00916-02

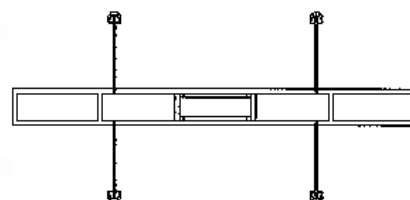
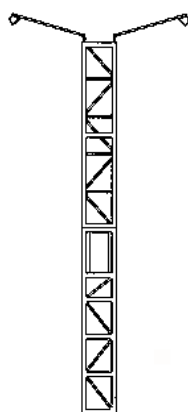
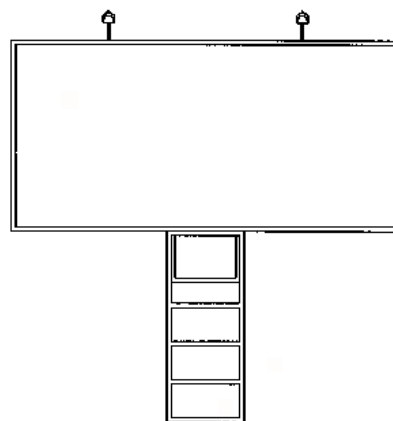
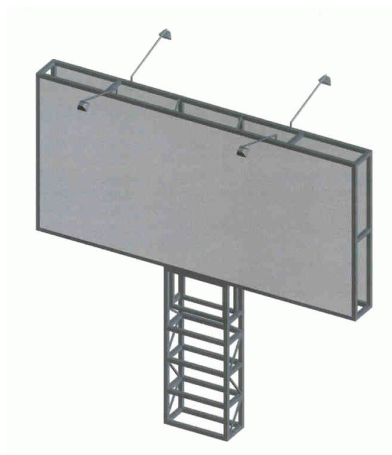

00916-03

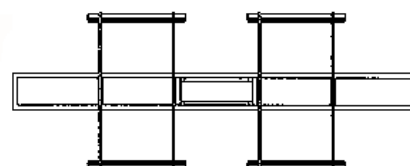
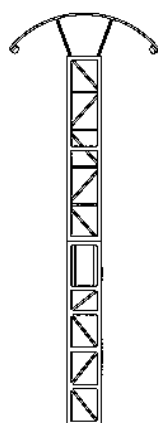
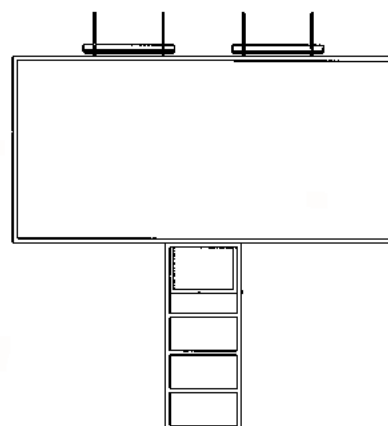
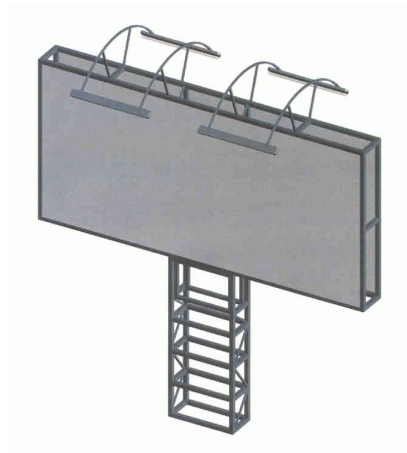

00916-04

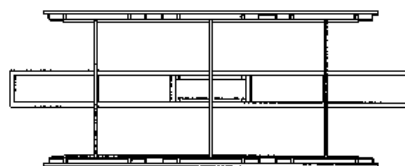
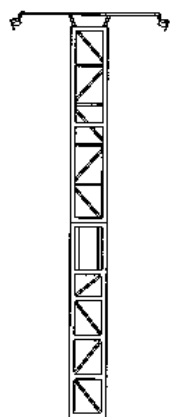
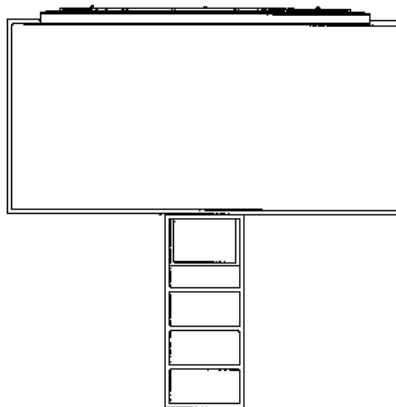
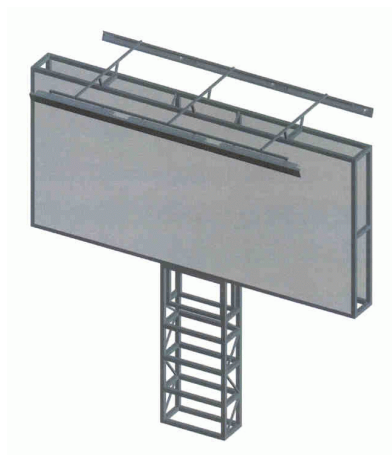

00916-05

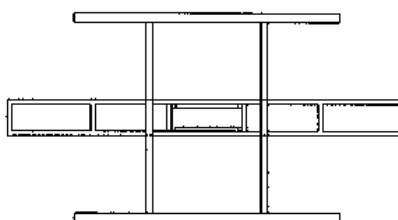
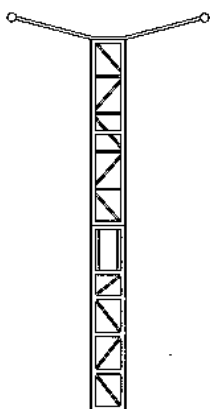
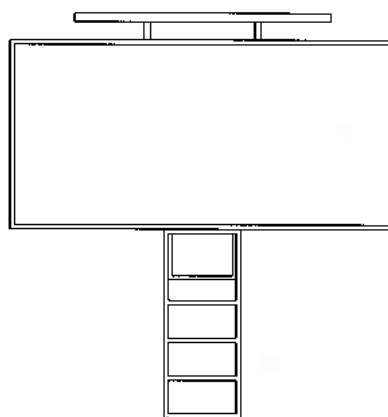
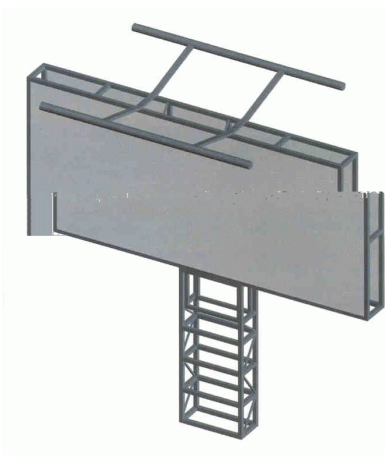

(11) Registreeringu number: **00917**

(51) Klass: **20-03**

(15) Registreerimise kuupäev: 19.02.2004

(21) Taotluse number: D200400009

(22) Esitamise kuupäev: 20.01.2004

(24) Registreeringu kehtivuse alguse kuupäev: 20.01.2004

(28) Variantide arv: 5

(72) Autor: Franklin D. McMahon, Tartu mnt 18, 10115 Tallinn, EE

(73) Omanik: UNICOM EESTI OÜ, Tartu mnt 18, 10115 Tallinn, EE

(74) Patendivolinik või ühine esindaja: Ott Moorlat

(54) Nimetus: **Valgustatud reklaamtahvel**

(55) Reproduktsoon:

00917-01

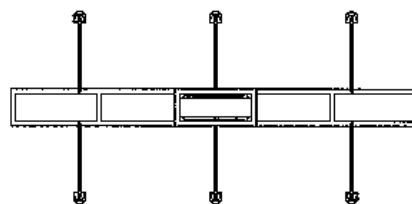
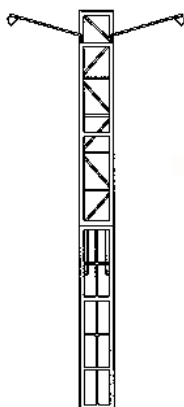
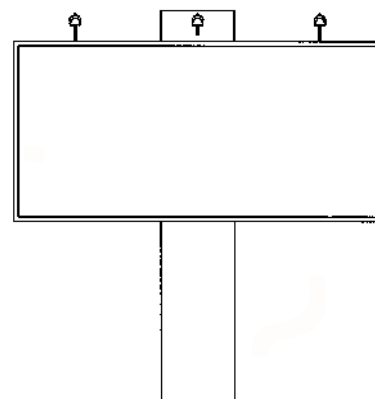
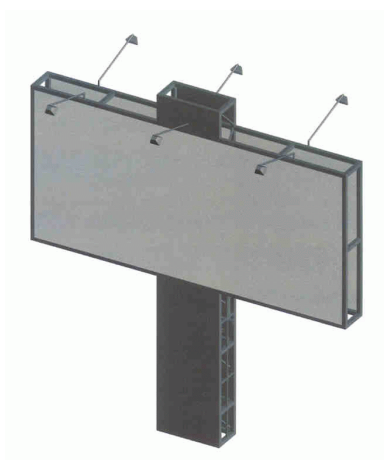

00917-02

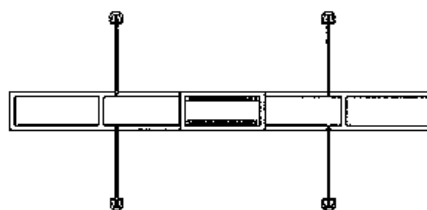
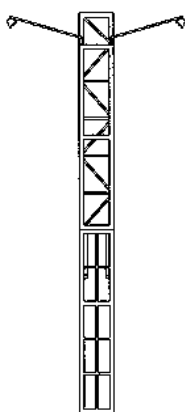
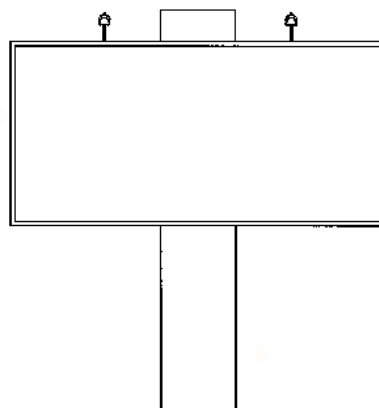
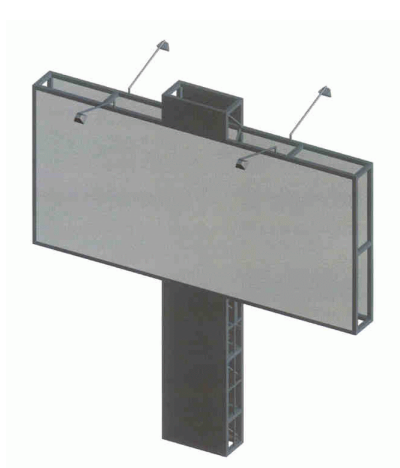

00917-03

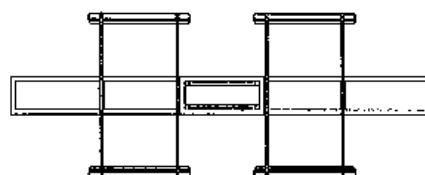
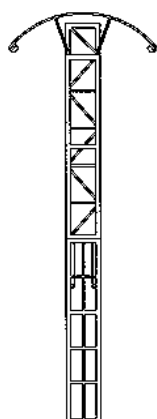
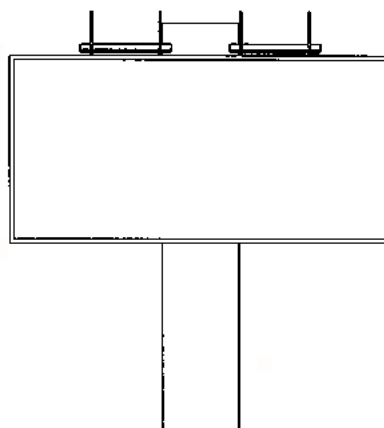
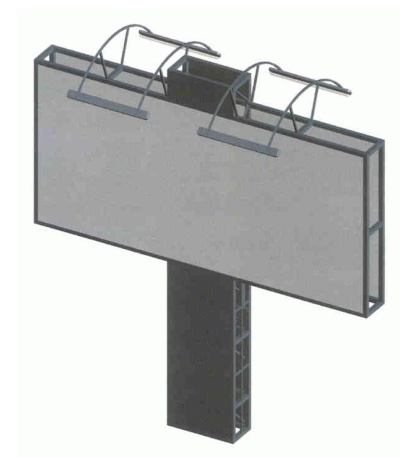

00917-04

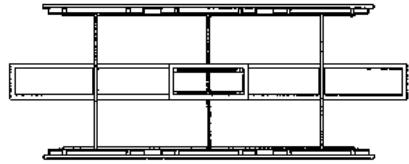
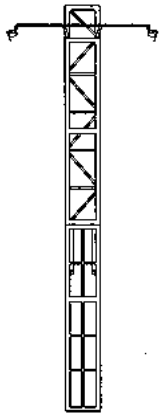
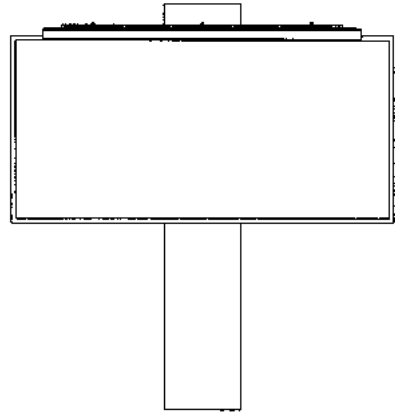
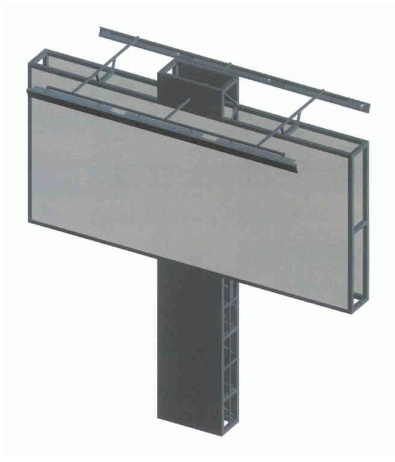

00917-05

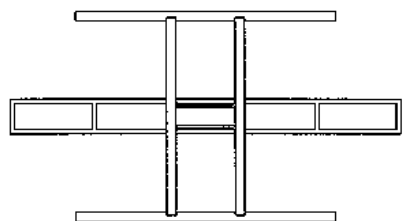
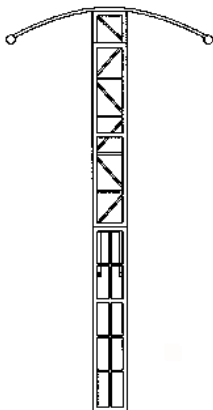
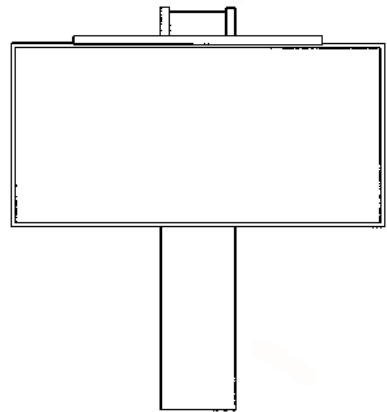

(11) Registreeringu number: **00918**

(51) Klass: **20-03**

(15) Registreerimise kuupäev: 19.02.2004

(21) Taotluse number: D200400010

(22) Esitamise kuupäev: 20.01.2004

(24) Registreeringu kehtivuse
alguse kuupäev: 20.01.2004

(28) Variantide arv: 5

(72) Autor: Franklin D. McMahon, Tartu mnt 18, 10115 Tallinn, EE

(73) Omanik: UNICOM EESTI OÜ, Tartu mnt 18, 10115 Tallinn, EE

(74) Patendivolinik või ühine esindaja: Ott Moorlat

(54) Nimetus: **Valgustatud reklaamtahvel**

(55) Reproduktsoon:

00918-01

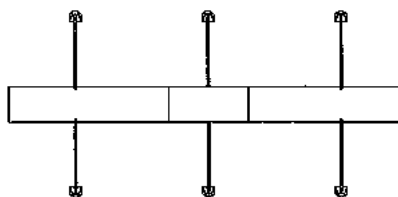
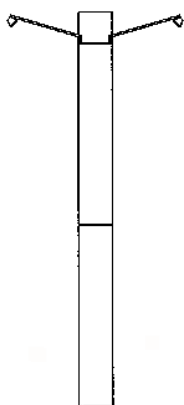
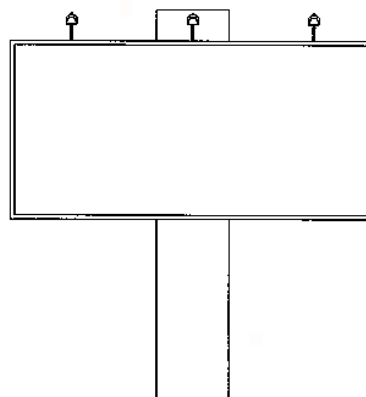
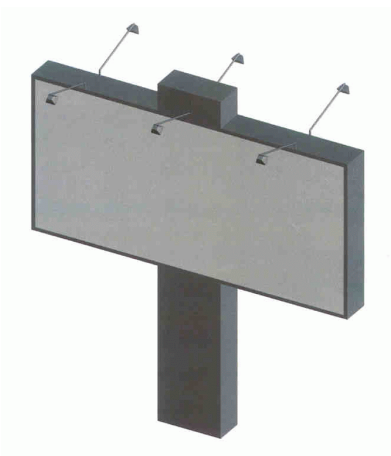

00918-02

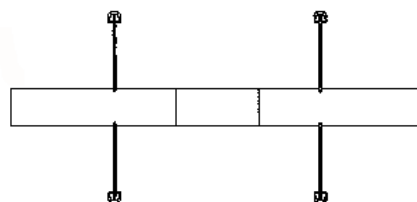
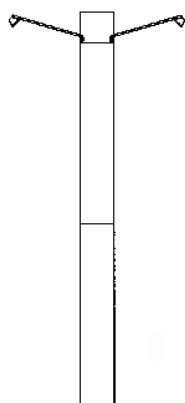
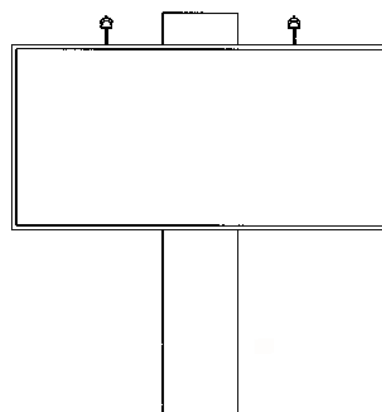
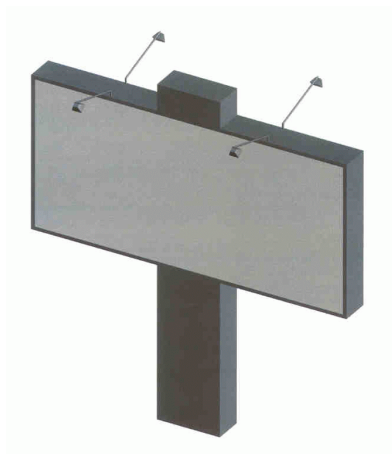

00918-03

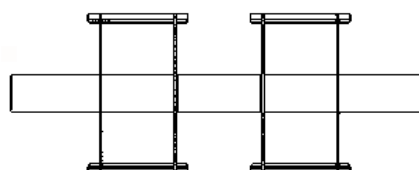
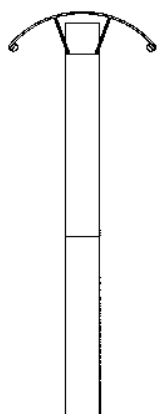
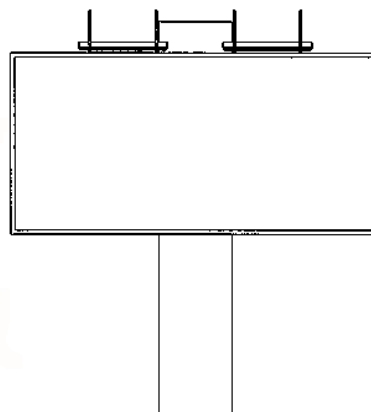
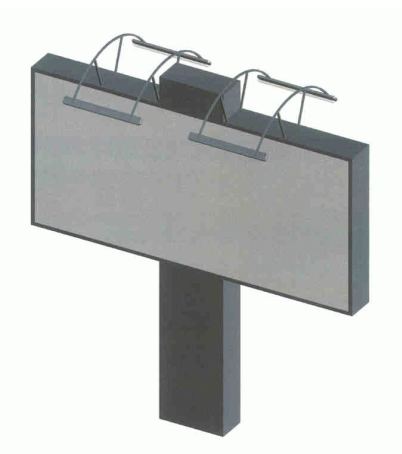

00918-04

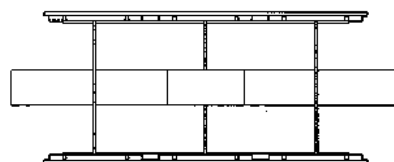
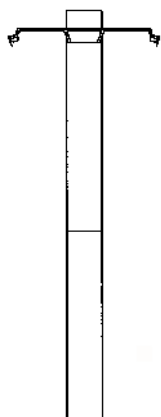
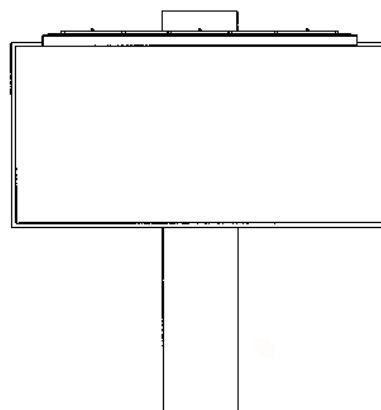
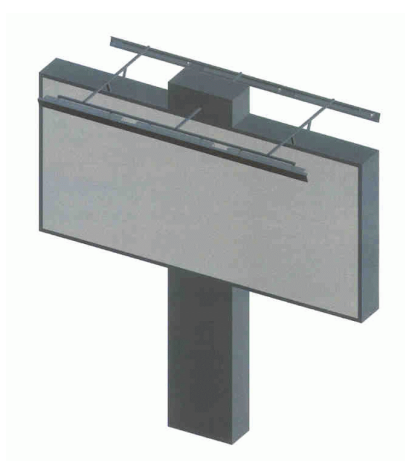

00918-05

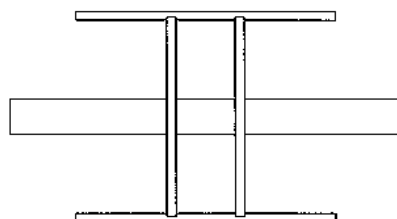
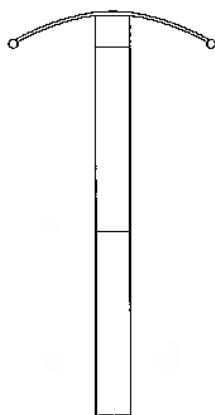
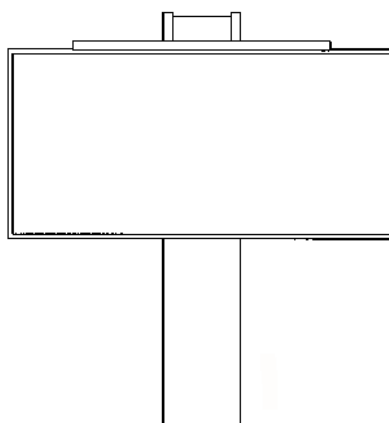
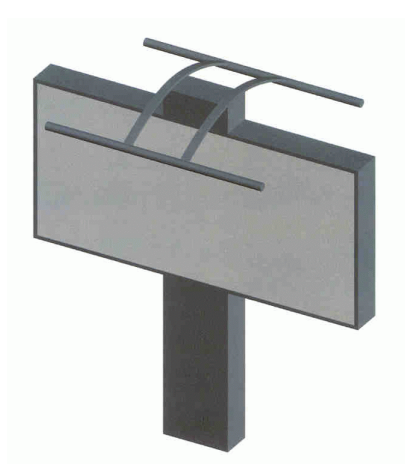

- (11) Registreeringu number: **00919** (51) Klass: **23-03**
- (15) Registreerimise kuupäev: 27.02.2004
- (21) Taotluse number: D200400016
- (22) Esitamise kuupäev: 05.02.2004
- (24) Registreeringu kehtivuse alguse kuupäev: 05.02.2004
- (28) Variantide arv: 2
- (72) Autor: Sergei Zagodorenko, K. Kärberi 12-55, 13812 Tallinn, EE
Vladislav Kremm, Öismäe tee 32-54, 13512 Tallinn, EE
- (73) Omanik: OÜ DELAKONIA, K. Kärberi 12-55, 13812 Tallinn, EE
OÜ SAUNAMAAILM, Pärnu mnt 234, 11622 Tallinn, EE
- (74) Patendivolinik või ühine esindaja: Lembit Kalev
- (54) Nimetus: **Sauna kütteseade**
- (55) Reproduktsoon:

00919-01



00919-02



- (11) Registreeringu number: **00920** (51) Klass: **06-01, 06-03, 21-03**
- (15) Registreerimise kuupäev: 04.03.2004
- (21) Taotluse number: D200400015
- (22) Esitamise kuupäev: 04.02.2004
- (24) Registreeringu kehtivuse alguse kuupäev: 04.02.2004
- (28) Variantide arv: 1
- (72) Autor: Andres Hunt, Vasalemma, Vesikiküla küla, Laagri talu, 76101 Harju maakond, EE
Toomas Kristov, Peterburi tee 4-17, 11411 Tallinn, EE
- (73) Omanik: OÜ Kivimees, Peterburi tee 4-17, 11411 Tallinn, EE
- (74) Patendivolinik või ühine esindaja: Lembit Kalev

(54) Nimetus: **Laste iste-laud-kiik**

(55) Reproduktsoon:

00920-01

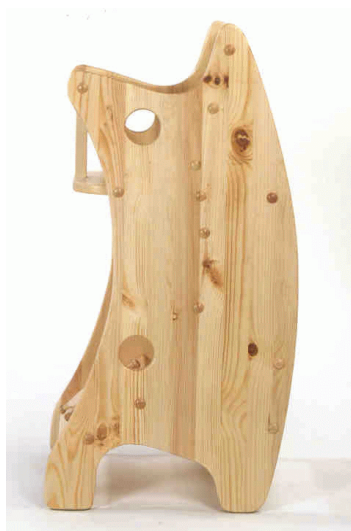



(11) Registreeringu number: **00921**

(51) Klass: **09-01**

(15) Registreerimise kuupäev: 10.03.2004

(21) Taotluse number: D200300139

(22) Esitamise kuupäev: 28.11.2003

(24) Registreeringu kehtivuse
alguse kuupäev: 28.11.2003

(28) Variantide arv: 2

(72) Autor: Peeter Rimmel, Laki 5, 10621 Tallinn, EE

Pearu Lehis, Laki 5, 10621 Tallinn, EE

(73) Omanik: AS Tehnoplast, Laki 5, 10621 Tallinn, EE

(74) Patendivolinik või ühine esindaja: Ott Moorlat

(54) Nimetus: **Pudel**

(55) Reproduktsoon:

00921-01

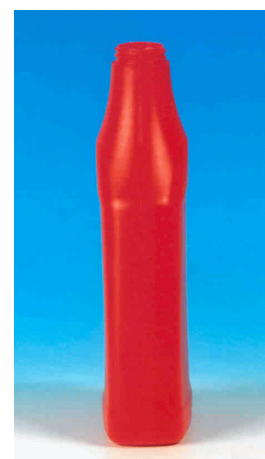
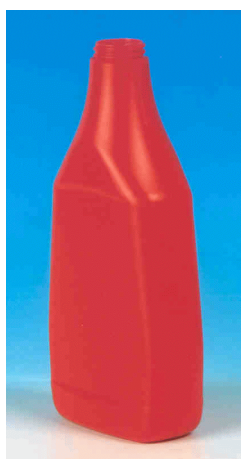

00921-02

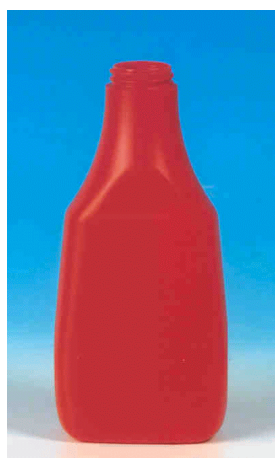
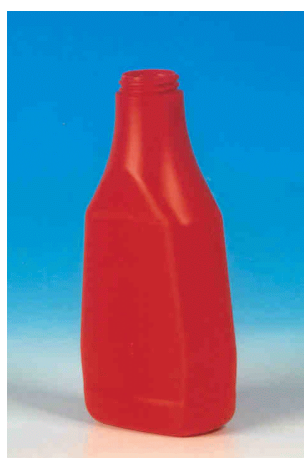

- (11) Registreeringu number: **00922** (51) Klass: **21-01**
- (15) Registreerimise kuupäev: 10.03.2004
- (21) Taotluse number: D200400011
- (22) Esitamise kuupäev: 21.01.2004
- (24) Registreeringu kehtivuse alguse kuupäev: 21.01.2004
- (28) Variantide arv: 3
- (30) Prioriteediandmed: 157 156, 23.07.2003, ES
- (72) Autor: Blanca Ros, Provenza 398, 02025 Barcelona, ES
- (73) Omanik: PEPSICO, INC., 700 Anderson Hill Road, Purchase, NY 10577-1444, US
- (74) Patendivolinik või ühine esindaja: Olga Treufeldt

(54) Nimetus: **Mängude müügienduse**

(55) Reproduktsoon:

00922-01

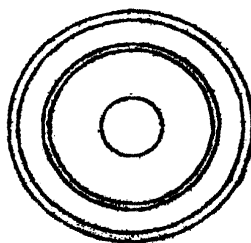
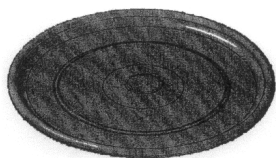

00922-02

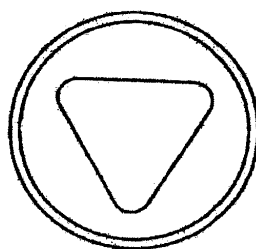
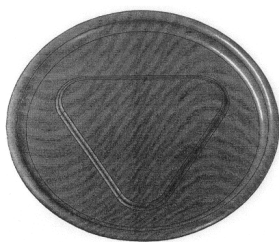

00922-03

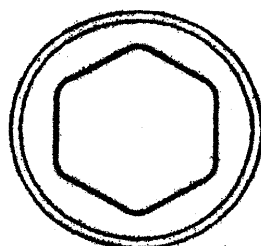
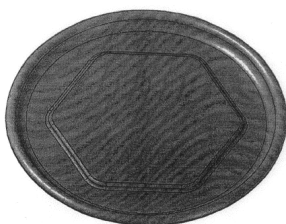

- (11) Registreeringu number: **00923** (51) Klass: **24-02**
- (15) Registreerimise kuupäev: 10.03.2004
- (21) Taotluse number: D200400012
- (22) Esitamise kuupäev: 27.01.2004
- (24) Registreeringu kehtivuse alguse kuupäev: 27.01.2004
- (28) Variantide arv: 1
- (30) Prioriteediandmed: 000066964-0001, 06.08.2003, EM
- (72) Autor: Martin Douglas Pearl, 18 Hilton Street, Over Cambridgeshire CB4 5PU, GB
Andrew Mark Bryant, 9 Old North Road, Bassingbourn cum Kneesworth, Cambridgeshire SG8 5JG, GB
Jonathan Hogwood, 7 Chalkhill Barrow, Melbourn, Royston Hertfordshire SG8 6EQ, GB
- (73) Omanik: Meridica Limited, Cambridge Technology Centre, Melbourn, Hertfordshire SG8 6 DQ, GB
- (74) Patendivolinik või ühine esindaja: Anfia Morna

(54) Nimetus: **Inhalaator**

(55) Reproduktsioon:

00923-01

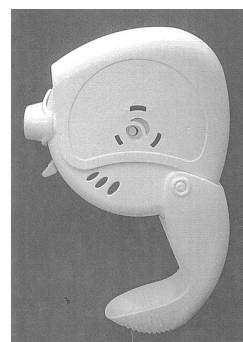
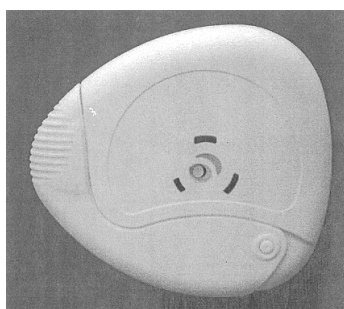
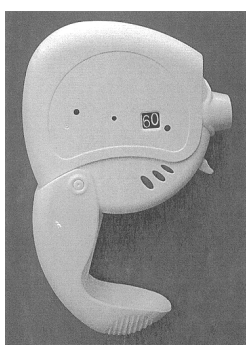
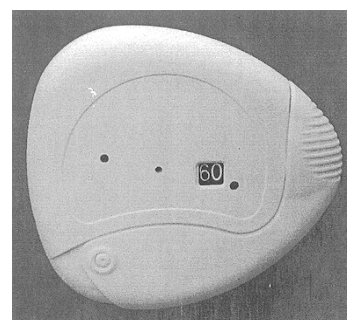
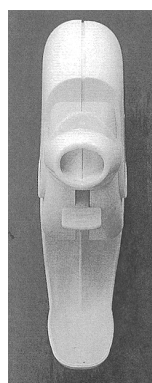
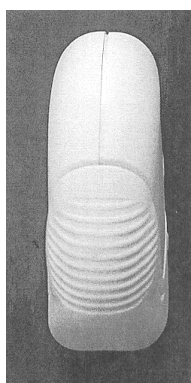

- (11) Registreeringu number: **00924** (51) Klass: **14-03**
- (15) Registreerimise kuupäev: 15.03.2004
- (21) Taotluse number: D200400013
- (22) Esitamise kuupäev: 02.02.2004
- (24) Registreeringu kehtivuse alguse kuupäev: 02.02.2004
- (28) Variantide arv: 1
- (30) Prioriteediandmed: 29/187,405, 01.08.2003, US
- (72) Autor: Anthony Dalby, 30, Chandos Avenue, Ealing, London W5 4 ER, GB
Joonsuh Kim, 4895 Lazio Way, Oak Park, CA 91377, US
Robert Pitt, 3 Dormy Cottages, Linchmere Road, Haslemere, Surrey GU27 3QW, GB
Tej Chauhan, 109 Beverley Drive, Edgware, Middlesex HA8 5NH, GB
Aaron Moss, 42 Collingwood, Farnborough, Hants GU14 6GL, GB
- (73) Omanik: Nokia Corporation, Keilalahdentie 4, FIN-02150 Espoo, FI
- (74) Patendivolinik või ühine esindaja: Kaie Puur

(54) Nimetus: **Käsitelefoni klaviatuur**

(55) Reproduktsioon:

00924-01

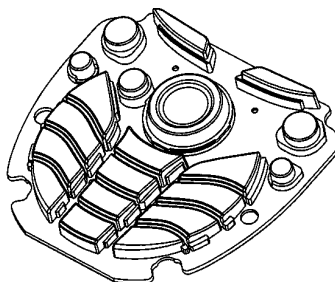
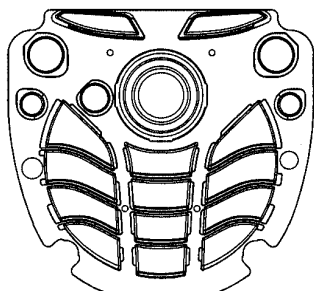

- (11) Registreeringu number: **00925** (51) Klass: **14-03**
- (15) Registreerimise kuupäev: 15.03.2004
- (21) Taotluse number: D200400014
- (22) Esitamise kuupäev: 02.02.2004
- (24) Registreeringu kehtivuse alguse kuupäev: 02.02.2004
- (28) Variantide arv: 1
- (30) Prioriteediandmed: 29/187,405, 01.08.2003, US
- (72) Autor: Anthony Dalby, 30, Chandos Avenue, Ealing, London W5 4 ER, GB
Joonsuh Kim, 4895 Lazio Way, Oak Park, CA 91377, US
Robert Pitt, 3 Dormy Cottages, Linchmere Road, Haslemere, Surrey GU27 3QW, GB
Tej Chauhan, 109 Beverley Drive, Edgware, Middlesex HA8 5NH, GB
Aaron Moss, 42 Collingwood, Farnborough, Hants GU14 6GL, GB
- (73) Omanik: Nokia Corporation, Keilalahdentie 4, FIN-02150 Espoo, FI
- (74) Patendivolinik või ühine esindaja: Kaie Puur

(54) Nimetus: **Käsitelefon**

(55) Reproduktsoon:

00925-01

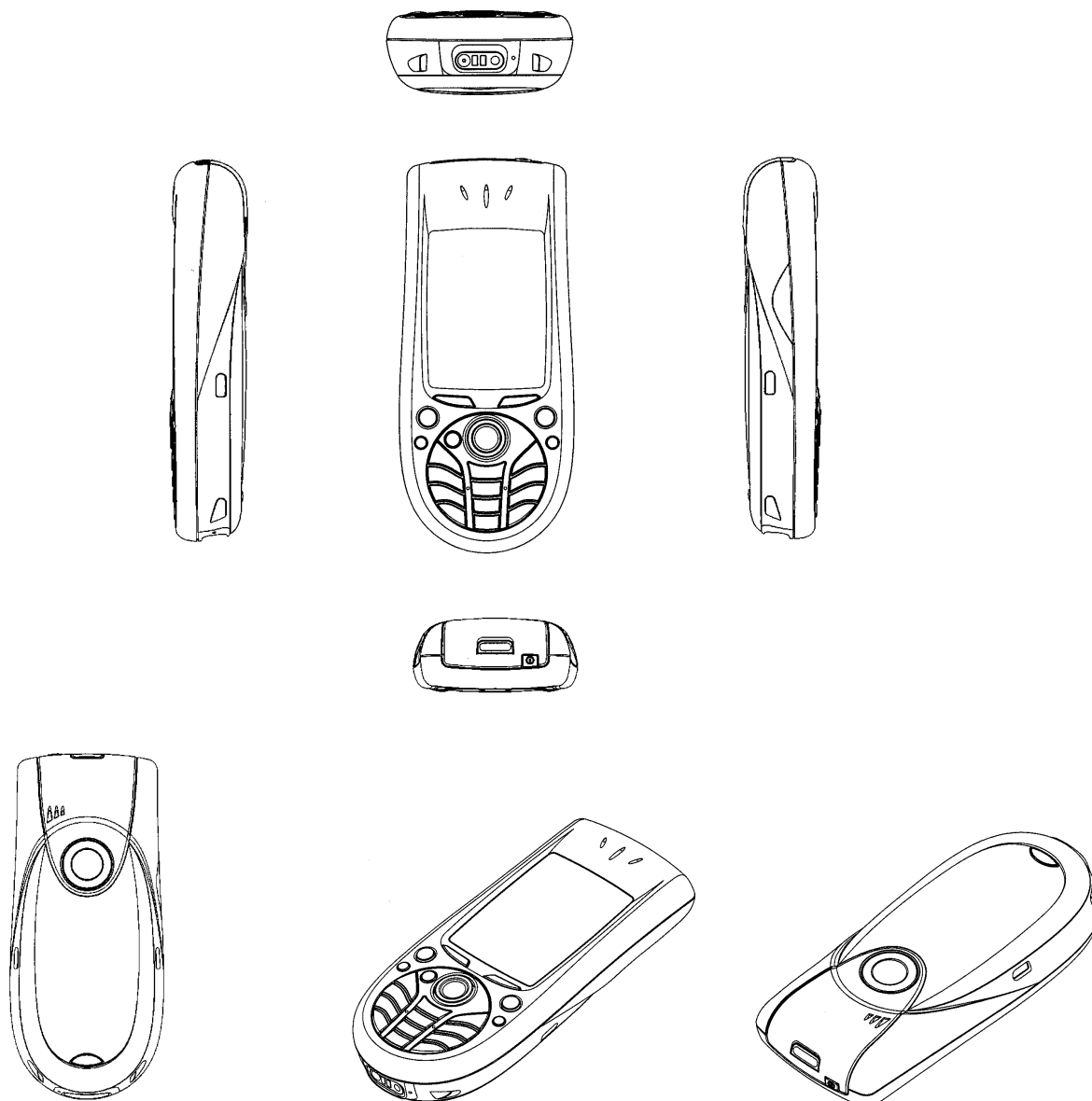

(11) Registreeringu number: **00926**

(51) Klass: **01-01**

(15) Registreerimise kuupäev: 15.03.2004

(21) Taotluse number: D200400017

(22) Esitamise kuupäev: 06.02.2004

(24) Registreeringu kehtivuse
alguse kuupäev: 06.02.2004

(28) Variantide arv: 1

(72) Autor: Veljo Kurik, Liivalaia 14-202, 10118 Tallinn, EE

(73) Omanik: Veljo Kurik, Liivalaia 14-202, 10118 Tallinn, EE

(54) Nimetus: **Valgest ja tumedast šoklaadist malelaud ja malendid**

(55) Reproduktsoon:

00926-01

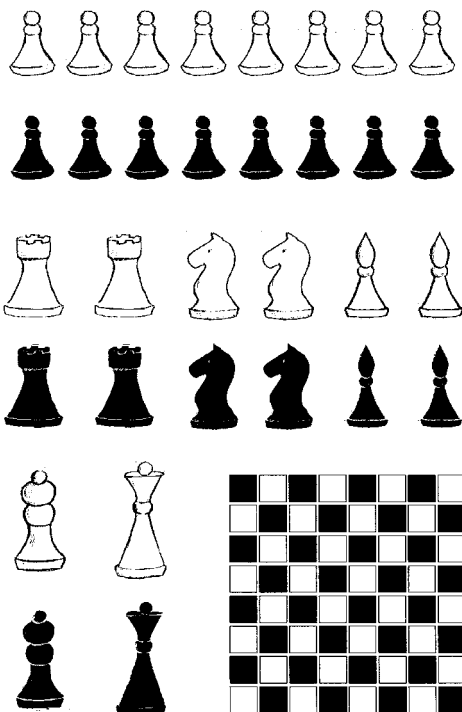

- (11) Registreeringu number: **00927** (51) Klass: **09-01**
- (15) Registreerimise kuupäev: 15.03.2004
- (21) Taotluse number: D200400031
- (22) Esitamise kuupäev: 02.03.2004
- (24) Registreeringu kehtivuse alguse kuupäev: 02.03.2004
- (28) Variantide arv: 1
- (30) Prioriteediandmed: 403 06 212.8, 19.09.2003, DE
- (72) Autor: Robin Goudsblom, Klingenberg Straße 105, 74080 Heilbronn, DE
- (73) Omanik: Lidl Stiftung & Co. KG, Stiftsbergstrasse 1, 74167 Neckarsulm, DE
- (74) Patendivolinik või ühine esindaja: Martina Böckler

(54) Nimetus: **Pudel**

(55) Reproduktsioon:

00927-01

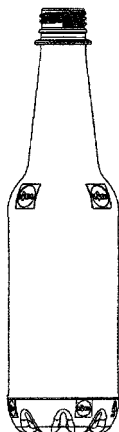
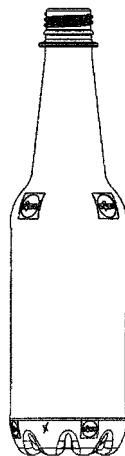
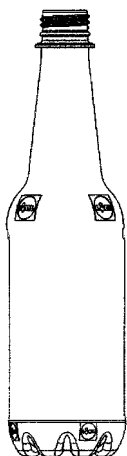

(11) Registreeringu number: **00928**

(51) Klass: **11-02**

(15) Registreerimise kuupäev: 15.03.2004

(21) Taotluse number: D200400032

(22) Esitamise kuupäev: 03.03.2004

(24) Registreeringu kehtivuse
alguse kuupäev: 03.03.2004

(28) Variantide arv: 2

(72) Autor: Heli Rõõm, Harju 1-30, 10146 Tallinn, EE

(73) Omanik: Heli Rõõm, Harju 1-30, 10146 Tallinn, EE

(74) Patendivolinik või ühine esindaja: Martina Böckler

(54) Nimetus: **Keraamiline kuju (ingel)**

(55) Reproduktsoon:

00928-01

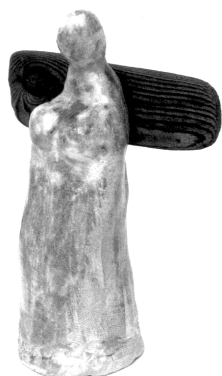

00928-02



- (11) Registreeringu number: **00929** (51) Klass: **14-99**
- (15) Registreerimise kuupäev: 23.03.2004
- (21) Taotluse number: D200300123
- (22) Esitamise kuupäev: 11.11.2003
- (24) Registreeringu kehtivuse alguse kuupäev: 11.11.2003
- (28) Variantide arv: 1
- (30) Prioriteediandmed: 2003-016986, 12.05.2003, JP
- (72) Autor: Teiyu Goto, c/o Sony Corporation, 7-35, Kitashinagawa 6-chome, Shinagawa-ku, Tokyo, JP
- (73) Omanik: Sony Computer Entertainment Inc., 2-6-21, Minami-Aoyama, Minato-ku, Tokyo 107-0062, JP
- (74) Patendivolinik või ühine esindaja: Kaie Puur

(54) Nimetus: **Kettakassett**

(55) Reproduktioon:

00929-01

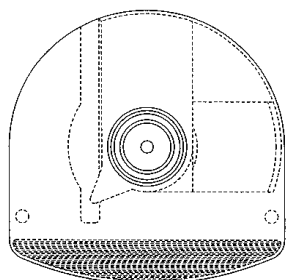
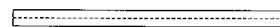
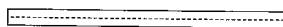
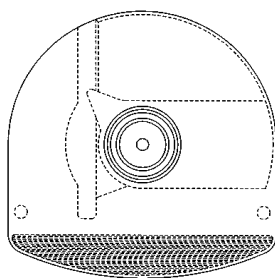
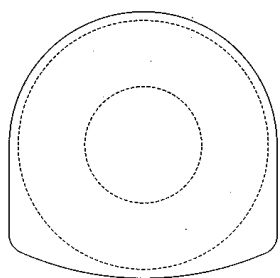

- (11) Registreeringu number: **00930** (51) Klass: **14-01, 14-02**
- (15) Registreerimise kuupäev: 23.03.2004
- (21) Taotluse number: D200300126
- (22) Esitamise kuupäev: 11.11.2003
- (24) Registreeringu kehtivuse alguse kuupäev: 11.11.2003
- (28) Variantide arv: 1
- (30) Prioriteediandmed: 2003-018786, 27.05.2003, JP
- (72) Autor: Masakazu Kanatani, c/o Sony Corporation, 7-35, Kitashinagawa 6-chome, Shinagawa-ku, Tokyo, JP
Hiroshi Yasutomi, c/o Sony Corporation, 7-35, Kitashinagawa 6-chome, Shinagawa-ku, Tokyo, JP
- (73) Omanik: Sony Computer Entertainment Inc., 2-6-21, Minami-Aoyama, Minato-ku, Tokyo 107-0062, JP
- (74) Patendivolinik või ühine esindaja: Kaie Puur

(54) Nimetus: **Kontroller**

(55) Reproduktsoon:

00930-01

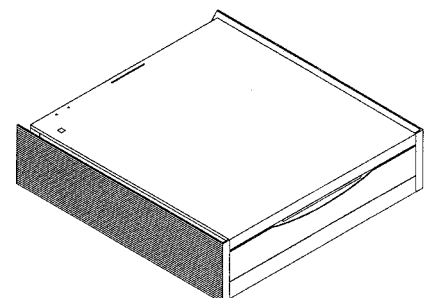
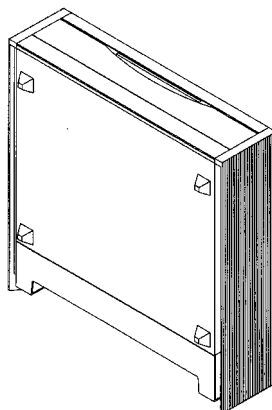
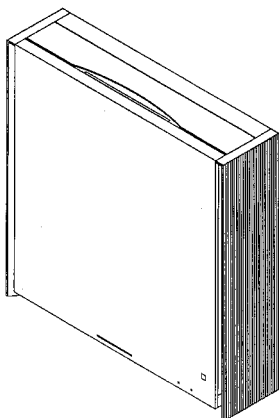
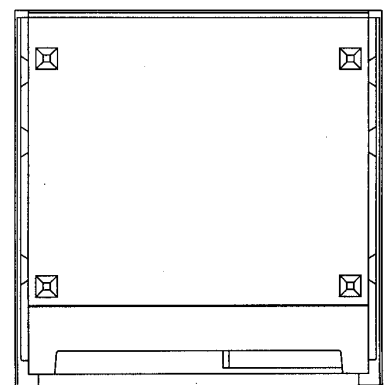
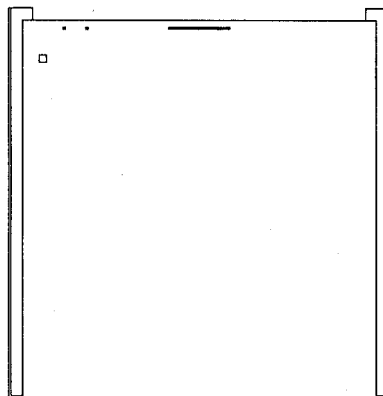
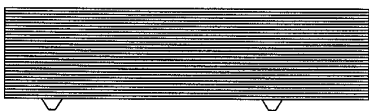
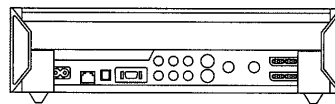
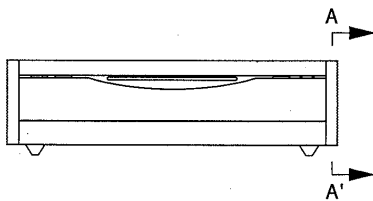

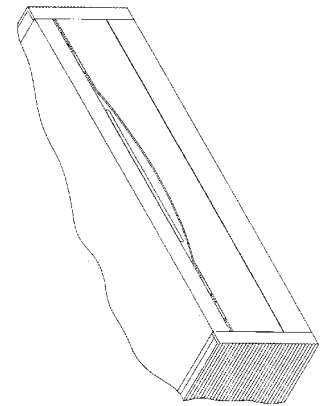
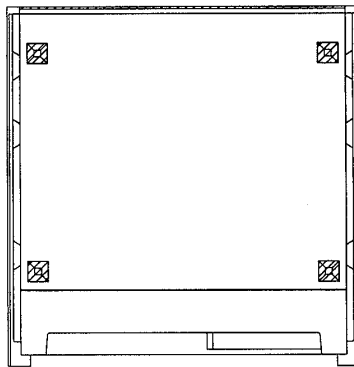
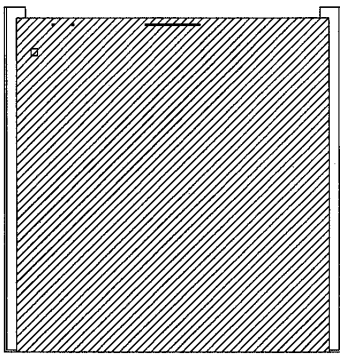
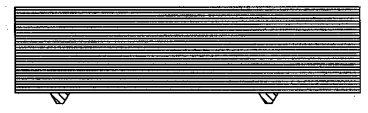
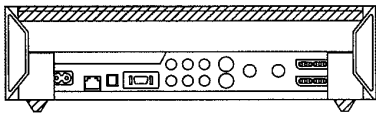
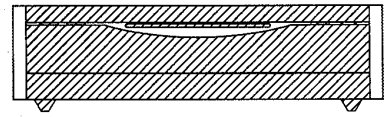
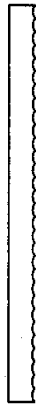
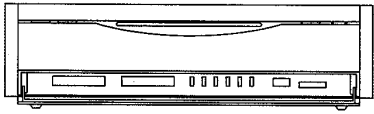

- (11) Registreeringu number: **00931** (51) Klass: **28-03**
- (15) Registreerimise kuupäev: 23.03.2004
- (21) Taotluse number: D200300140
- (22) Esitamise kuupäev: 04.12.2003
- (24) Registreeringu kehtivuse alguse kuupäev: 04.12.2003
- (28) Variantide arv: 1
- (72) Autor: Carl Dinbah, 5 Navigation Way, Victoria Dock, Hull HU9 1SW, GB
Andrew Robert McLeish, Pure Realisation, 4 Brooklyn Works, Green Lane, Sheffield S3 8SH, GB
Jean-Francois L'Hoste, 3 Impasse Des Tilleuls, 28630 Le Codray, FR
- (73) Omanik: Reckitt Benckiser (UK) Limited, 103-105 Bath Road, Slough, Berkshire SL1 3UH, GB
- (74) Patendivolinik või ühine esindaja: Olga Treufeldt
- (54) Nimetus: **Karvaärastusvahend**
- (55) Reproduktsoon:
- 00931-01

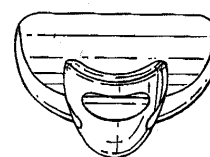
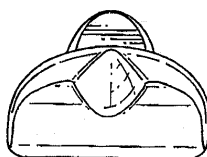
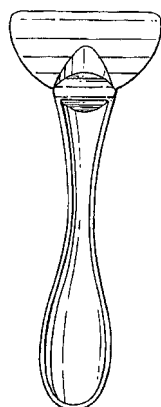
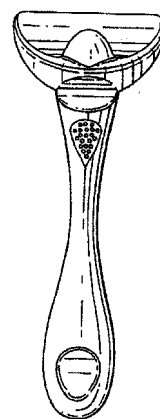
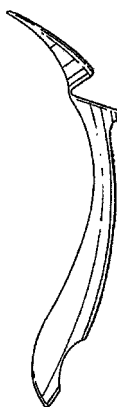
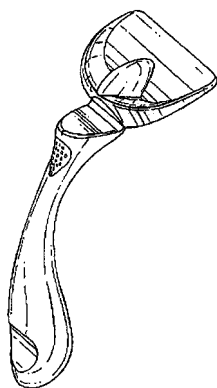

- (11) Registreeringu number: **00932** (51) Klass: **14-03**
- (15) Registreerimise kuupäev: 23.03.2004
- (21) Taotluse number: D200400019
- (22) Esitamise kuupäev: 19.02.2004
- (24) Registreeringu kehtivuse alguse kuupäev: 19.02.2004
- (28) Variantide arv: 1
- (30) Prioriteediandmed: M20030251, 23.10.2003, FI
- (72) Autor: Pekka Majanen, Verkaranta 5 D 43, 20660 Littoinen, FI
- (73) Omanik: Nokia Corporation, Keilalahdentie 4, FIN-02150 Espoo, FI
- (74) Patendivolinik või ühine esindaja: Kaie Puur

(54) Nimetus: **Käsitelefon**

(55) Reproduktsoon:

00932-01

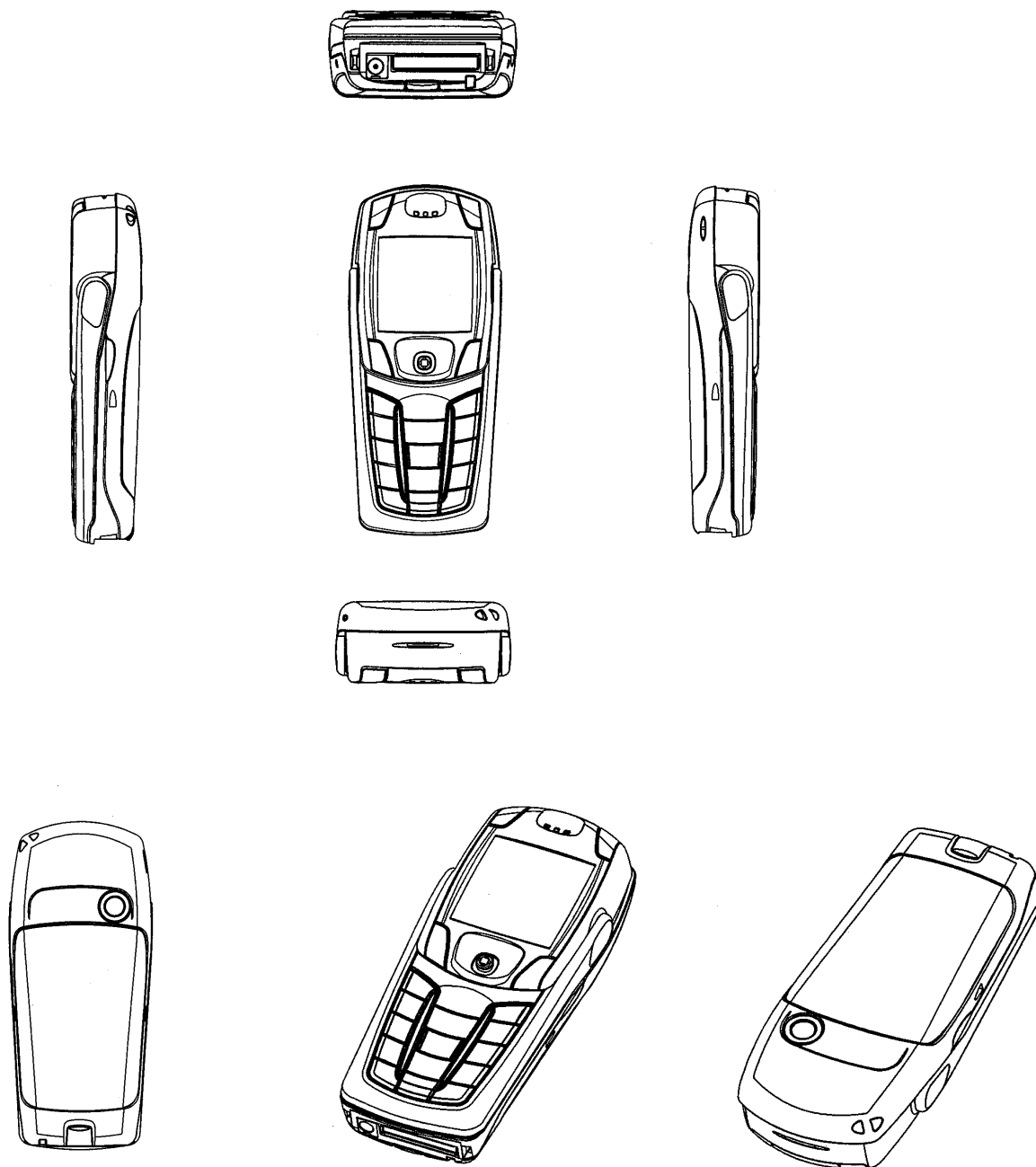

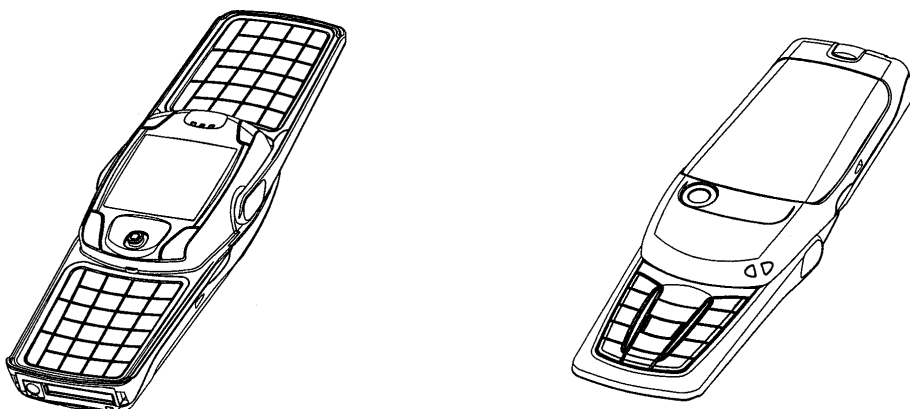
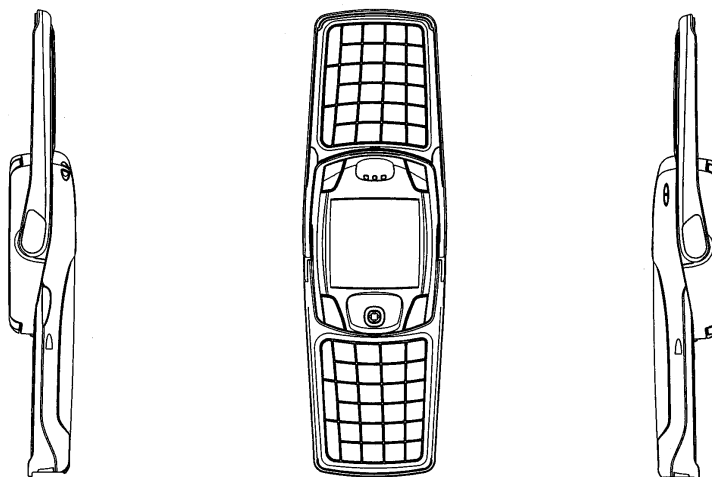

(11) Registreeringu number: **00933**

(51) Klass: **13-02**

(15) Registreerimise kuupäev: 23.03.2004

(21) Taotluse number: D200400020

(22) Esitamise kuupäev: 20.02.2004

(24) Registreeringu kehtivuse alguse kuupäev: 20.02.2004

(28) Variantide arv: 1

(30) Prioriteediandmed: M20030203, 22.08.2003, FI

(72) Autor: Heli Säde, Liitoskatu 11, 24260 Salo, FI

(73) Omanik: Tapani Jokinen, Lahntie 9 as 18, 20760 Piispanristi, FI

(74) Patendivolinik või ühine esindaja: Nokia Corporation, Keilalahdentie 4, FIN-02150 Espoo, FI

(74) Patendivolinik või ühine esindaja: Kaie Puur

(54) Nimetus: **Reisilaadija**

(55) Reproduktsoon:

00933-01

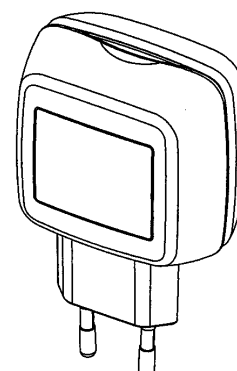
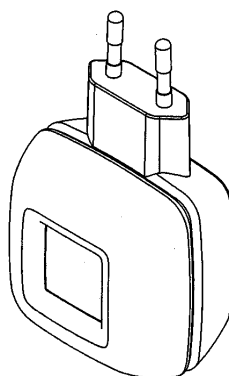
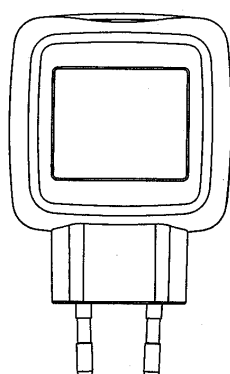
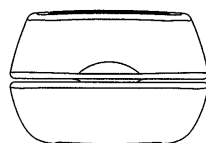
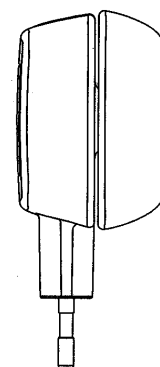
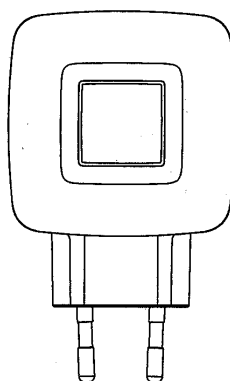
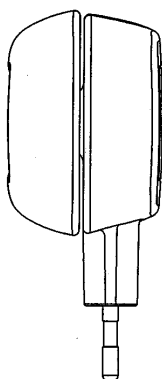
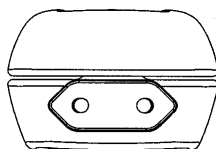

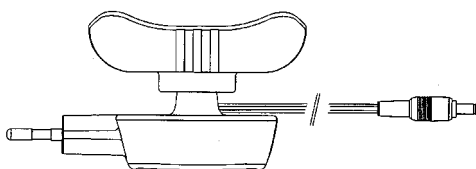
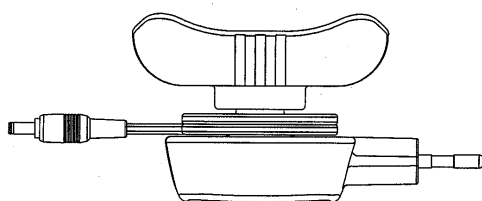
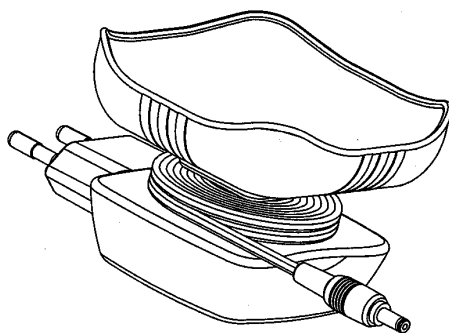

II. TÖÖSTUSDISAINILAHENDUSE REGISTREERINGU KEHTIVUSE PIKENDAMINE

(11)	(18)
00346	05.02.2009
00347	05.02.2009
00348	16.02.2009
00360	02.02.2009
00364	22.03.2009
00367	01.04.2009
00369	16.04.2009
00370	15.02.2009
00371	09.04.2009
00400	09.08.2009
00422	30.07.2009

III. TÖÖSTUSDISAINILAHENDUSE REGISTREERINGU ANDMETE MUUTMINE

Reg nr	Muudetud andmed	Õiguste ülemineku kuupäev	Registrikande jõustumise kuupäev
00262	(73) OÜ Müomeetria, Raatuse 20, 51009 Tartu, EE	05.04.2004	27.04.2004

Reg nr	Muudetud andmed	Registrikande jõustumise kuupäev
00367	(73) AS Tirsi Kinnisvara Haldus, Turu 37a, 50106 Tartu, EE	19.03.2004
00370	(73) Metsä Tissue GmbH, Hochkoppelmühle, 52372 Kreuzau, DE	27.02.2004

V. TÖÖSTUSDISAINILAHENDUSE REGISTREERINGU KUSTUTAMINE

(11)

00295	00303
00296	00307
00297	00308
00299	00313
00300	00314
00301	00322
00302	00323

VII. LOENDID

REGISTREERITUD TÖÖSTUSDISAINILAHENDUSTE
SÜSTEMAATILINE LOEND

Rahvusvahelise klassifikatsiooni klass ja alaklass(id)	Registreerimis- taotluse number	Registreeringu number			
01-01	D200400017	00926	14-03	D200300142	00894
06-01	D200400015	00920	14-03	D200300143	00895
06-03	D200400015	00920	14-03	D200300144	00896
07-02	D200300157	00910	14-03	D200300145	00897
07-05	D200400003	00912	14-03	D200300147	00899
09-01	D200300139	00921	14-03	D200400013	00924
09-01	D200300152	00905	14-03	D200400014	00925
09-01	D200300153	00906	14-03	D200400019	00932
09-01	D200300154	00907	14-99	D200300123	00929
09-01	D200400002	00911	16-01	D200300146	00898
09-01	D200400031	00927	20-03	D200300149	00902
09-07	D200300151	00904	20-03	D200300150	00903
11-02	D200400032	00928	20-03	D200300155	00908
13-02	D200400020	00933	20-03	D200300156	00909
14-01	D200300126	00930	20-03	D200400005	00913
14-01	D200300145	00897	20-03	D200400006	00914
14-02	D200300126	00930	20-03	D200400007	00915
14-03	D200300109	00900	20-03	D200400008	00916
14-03	D200300110	00901	20-03	D200400009	00917
14-03	D200300125	00884	20-03	D200400010	00918
14-03	D200300132	00886	21-01	D200300129	00885
14-03	D200300133	00887	21-01	D200400011	00922
14-03	D200300134	00888	21-03	D200300129	00885
14-03	D200300135	00889	21-03	D200400015	00920
14-03	D200300136	00890	23-03	D200400016	00919
14-03	D200300137	00891	24-02	D200400012	00923
14-03	D200300138	00892	25-01	D200300117	00883
14-03	D200300141	00893	28-03	D200300140	00931

**REGISTREERITUD TÖÖSTUSDISAINILAHENDUSTE REGISTREERIMISTAOTLUSTE
NUMBRILINE LOEND**

Registreerimis- taotluse number	Registreeringu number	Rahvusvahelise klassifikatsiooni klass(id) ja alaklass(id)
------------------------------------	--------------------------	--

D200300109	00900	14-03	D200300151	00904	09-07
D200300110	00901	14-03	D200300152	00905	09-01
D200300117	00883	25-01	D200300153	00906	09-01
D200300123	00929	14-99	D200300154	00907	09-01
D200300125	00884	14-03	D200300155	00908	20-03
D200300126	00930	14-01	D200300156	00909	20-03
D200300126	00930	14-02	D200300157	00910	07-02
D200300129	00885	21-01	D200400002	00911	09-01
D200300129	00885	21-03	D200400003	00912	07-05
D200300132	00886	14-03	D200400005	00913	20-03
D200300133	00887	14-03	D200400006	00914	20-03
D200300134	00888	14-03	D200400007	00915	20-03
D200300135	00889	14-03	D200400008	00916	20-03
D200300136	00890	14-03	D200400009	00917	20-03
D200300137	00891	14-03	D200400010	00918	20-03
D200300138	00892	14-03	D200400011	00922	21-01
D200300139	00921	09-01	D200400012	00923	24-02
D200300140	00931	28-03	D200400013	00924	14-03
D200300141	00893	14-03	D200400014	00925	14-03
D200300142	00894	14-03	D200400015	00920	06-01
D200300143	00895	14-03	D200400015	00920	06-03
D200300144	00896	14-03	D200400015	00920	21-03
D200300145	00897	14-01	D200400016	00919	23-03
D200300145	00897	14-03	D200400017	00926	01-01
D200300146	00898	16-01	D200400019	00932	14-03
D200300147	00899	14-03	D200400020	00933	13-02
D200300149	00902	20-03	D200400031	00927	09-01
D200300150	00903	20-03	D200400032	00928	11-02

VIII. TÖÖSTUSDISAINIALASED ÕIGUSAKTID JA MUU INFO

RIIKLIKUS PATENDIVOLNIKE REGISTRIS REGISTREERITUD PATENDIVOLNIKE NIMEKIRI (seisuga 21. jaanuar 2004)

Register on asutatud 1. septembril 2001. a Vabariigi Valitsuse 7. augusti 2001. a määrusega nr 271 "Riikliku patendivolinike registri asutamine ja registri pidamise põhimäärus" (RT I 2001, 70, 426) patendivoliniku seaduse § 21 alusel (RT I 2001, 27, 151).

TEGEVUSVALDKOND: KAUBAMÄRK, TÖÖSTUSDISAINILAHENDUS JA GEOGRAAFILINE TÄHIS

Arno ANIJALG	OÜ USTERVALL Raekoja plats 16 51004 Tartu pk 21, 50002 Tartu telefon: 744 1980 telefaks: 744 1785 e-post: anijalg@ustervall.ee http://www.ustervall.ee võõrkeeled: saksa, vene	Uno JÄÄGER	Patendibüroo Käosaar & Co OÜ Rüütli 51A, 80010 Pärnu telefon: 447 1021 telefaks: 447 1001 GSM: 551 1758 e-post: uno@estpak.ee http://www.kaosaar.ee võõrkeeled: inglise, soome, vene
Aivo ARULA	Patendibüroo Käosaar & Co OÜ Tähe 94 50107 Tartu telefon: 738 3051 telefaks: 738 3055 e-post: info@kaosaar.ee http://www.kaosaar.ee võõrkeeled: inglise, vene	Sirje KAHU	OÜ USTERVALL Raekoja plats 16 51004 Tartu pk 21, 50002 Tartu telefon: 744 1980 telefaks: 744 1785 e-post: skahu@ustervall.ee http://www.ustervall.ee võõrkeeled: inglise, vene
Martina BÖCKLER	OÜ LASVET Suurtüki 4a, 10133 Tallinn pk 3136, 10505 Tallinn telefon: 640 6600 telefaks: 640 6604 e-post: lasvet@lasvet.ee http://www.lasvet.ee võõrkeeled: inglise, vene, soome	Lembit KALEV	Patendibüroo ROOSILLA OÜ Järveotsa tee 39-61 13520 Tallinn telefon: 657 1722, 657 5381 telefaks: 657 5381 GSM: 511 9951 e-post: roosilla@roosilla.ee http://www.roosilla.ee võõrkeeled: inglise, vene
Alla HÄMMALOV	OÜ Intels Riia 11-3 51010 Tartu telefon: 742 0401 telefaks: 742 0326 e-post: intelses@estpak.ee võõrkeeled: inglise, poola, vene	Urmas KAULER	Patendibüroo TURVAJA OÜ Liivalaia 22 10118 Tallinn telefon: 640 3109 telefaks: 640 3105 e-post: kauler@turvaja.ee http://www.turvaja.ee võõrkeeled: inglise, vene, soome
Juhan HÄMMALOV	OÜ Intels Riia 11-3 51010 Tartu telefon: 742 0401 telefaks: 742 0326 e-post: intelses@estpak.ee võõrkeeled: inglise, saksa, vene	Urmas KERNU	AAA Patendibüroo OÜ Tartu mnt 16 10117 Tallinn pk 3926, 10509 Tallinn telefon: 660 5910, 660 5911 telefaks: 660 5912 e-post: aaa@aaa.ee http://www.aaa.ee võõrkeeled: inglise, saksa, soome, vene

- Ljubov KESSELMAN** **OÜ Kesna**
 Tedre 77-52
 10616 Tallinn
 telefon: 660 8068
 telefaks: 660 8069
 e-post: kesna@online.ee
 võõrkeeled: inglise, vene
- Marina KESSELMAN** **OÜ Kesna**
 Tedre 77-52
 10616 Tallinn
 telefon: 660 8068
 telefaks: 660 8069
 e-post: kesna@online.ee
 võõrkeeled: inglise, saksa, vene
- Heinu KOITEL** **Patendi- & Kaubamärgibüroo Koitel OÜ**
 Tartu mnt 65
 10115 Tallinn
 pk 1759, 10902 Tallinn
 telefon: 603 3260
 telefaks: 603 3261
 e-post: koitel@koitel.ee
<http://www.koitel.ee>
 võõrkeeled: inglise, soome, vene
- Raivo KOITEL** **Patendi- & Kaubamärgibüroo Koitel OÜ**
 Tartu mnt 65
 10115 Tallinn
 pk 1759, 10902 Tallinn
 telefon: 603 3260
 telefaks: 603 3261
 e-post: koitel@koitel.ee
<http://www.koitel.ee>
 võõrkeeled: inglise, soome, vene
- Mart-Enn KOPPEL** kontaktandmed:
 OÜ Advokaadibüroo Andrus Lillo
 Rüütli 14, 51007 Tartu
 telefon: 730 3470
 GSM: 525 0595
 telefaks: 730 3471
 e-post: info@koppelpb.com
<http://www.koppelpb.com>
 võõrkeeled: inglise, vene, soome
- Heinrich KRUPP** **Patendibüroo TURVAJA OÜ**
 Liivalaia 22
 10118 Tallinn
 telefon: 640 3109
 telefaks: 640 3105
 e-post: turvaja@turvaja.ee
<http://www.turvaja.ee>
 võõrkeeled: saksa, vene
- Jüri KÄOSAAR** **Patendibüroo Käosaar & Co OÜ**
 Tähe 94
 50107 Tartu
 telefon: 738 3051
 telefaks: 738 3055
 e-post: info@kaosaar.ee
<http://www.kaosaar.ee>
 võõrkeeled: inglise, vene
- Reet MAASIKAMÄE** **OÜ Kaitsepurus**
 Mulla 4-3
 10611 Tallinn
 telefon: 673 9097, 633 2798
 telefaks: 677 4844
 e-post: purus@online.ee
 purus@hot.ee
<http://www.hot.ee/purus/>
 võõrkeeled: inglise, vene
- Raivo MATSOO** **RM Hirvela Patendibüroo OÜ**
 Saku 15, 11314 Tallinn
 telefon: 614 0816
 telefaks: 614 0818
 e-post: hirvela@online.ee
 võõrkeeled: inglise, vene
- Elle MELLIK** **AAA Patendibüroo OÜ**
 Tartu mnt 16
 10117 Tallinn
 pk 3926, 10509 Tallinn
 telefon: 660 5910, 660 5911
 telefaks: 660 5912
 e-post: aaa@aaa.ee
<http://www.aaa.ee>
 võõrkeeled: inglise, vene
- Lembit MITT** **AAA Patendibüroo OÜ**
 Tartu mnt 16
 10117 Tallinn
 pk 3926, 10509 Tallinn
 telefon: 660 5910, 660 5911
 telefaks: 660 5912
 e-post: aaa@aaa.ee
<http://www.aaa.ee>
 võõrkeeled: inglise, vene
- Ott MOORLAT** **OÜ Moorlat & Ko Patendibüroo**
 pk 723, 12902 Tallinn
 telefon: 655 0450, 654 2844
 telefaks: 654 2844
 e-post: ott.moorlat@moorlat.ee
<http://www.moorlat.ee>
 võõrkeeled: inglise, vene

Anfia MORNA	Patendibüroo TURVAJA OÜ Liivalaia 22, 10118 Tallinn telefon: 640 3109 telefaks: 640 3105 e-post: morna@turvaja.ee http://www.turvaja.ee võõrkeeled: inglise, vene	Kaie PUUR	Patendibüroo Käosaar & Co OÜ Tähe 94 50107 Tartu telefon: 738 3051 telefaks: 738 3055 e-post: info@kaosaar.ee http://www.kaosaar.ee võõrkeeled: inglise, vene
Tõnu NELNAS	AAA Patendibüroo OÜ Tartu mnt 16 10117 Tallinn pk 3926, 10509 Tallinn telefon: 660 5910, 660 5911 telefaks: 660 5912 e-post: aaa@aaa.ee http://www.aaa.ee võõrkeeled: inglise, vene, soome	Tarmo ROSMAN	Rosman ja Partnerid OÜ pk 652, 12602 Tallinn telefon: 656 1450 telefaks: 656 1450 e-post: tarman@cc.ttu.ee võõrkeeled: saksa, inglise, ungari, vene
Jüri OLT	Patendibüroo Käosaar & Co OÜ Tähe 94, 50107 Tartu telefon: 738 3051 telefaks: 738 3055 e-post: info@kaosaar.ee http://www.kaosaar.ee võõrkeeled: inglise, saksa, soome, vene	Arvo SALUMÄE	OÜ Amende Patendibüroo Raua 65 10152 Tallinn telefon: 648 6125 telefaks: 641 0174 e-post: amende@hot.ee võõrkeeled: inglise, saksa, soome, vene
Jaak OSTRAT	OÜ LASVET Suurtüki 4a, 10133 Tallinn pk 3136, 10505 Tallinn telefon: 640 6600 telefaks: 640 6604 e-post: lasvet@lasvet.ee http://www.lasvet.ee võõrkeeled: inglise, saksa, soome, vene	Harald TEHVER	Patendibüroo TURVAJA OÜ Liivalaia 22 10118 Tallinn telefon: 640 3109 telefaks: 640 3105 e-post: tehver@turvaja.ee http://www.turvaja.ee võõrkeeled: inglise, saksa, vene
Villu PAVELTS	OÜ LASVET Suurtüki 4a, 10133 Tallinn pk 3136, 10505 Tallinn telefon: 640 6600 telefaks: 640 6604 e-post: lasvet@lasvet.ee http://www.lasvet.ee võõrkeeled: inglise, soome, vene	Olga TREUFELDT	Patendibüroo TURVAJA OÜ Liivalaia 22 10118 Tallinn telefon: 640 3109 telefaks: 640 3105 e-post: olga@turvaja.ee http://www.turvaja.ee võõrkeeled: inglise, vene
Anneli PUNGAS	OÜ Synest pk 977, 13402 Tallinn telefon: 660 9786 telefaks: 660 9787 e-post: anneli@synest.ee võõrkeeled: inglise, saksa, vene, prantsuse, soome, rootsi	Enn URGAS	Patendibüroo TURVAJA OÜ Liivalaia 22 10118 Tallinn telefon: 640 3109 telefaks: 640 3105 e-post: urgas@turvaja.ee http://www.turvaja.ee võõrkeeled: inglise, vene
Toom PUNGAS	OÜ Synest pk 977, 13402 Tallinn telefon: 660 9786 telefaks: 660 9787 e-post: toom@synest.ee võõrkeeled: inglise, saksa, soome, vene	Juta-Maris UUSTALU	OÜ LASVET Suurtüki 4a, 10133 Tallinn pk 3136, 10505 Tallinn telefon: 640 6600 telefaks: 640 6604 e-post: lasvet@lasvet.ee http://www.lasvet.ee võõrkeeled: inglise, vene

**LIST OF PATENT ATTORNEYS, REGISTERED IN
THE ESTONIAN STATE REGISTER OF PATENT ATTORNEYS**
(by 21 January 2004)

Register is established on September 1st 2001

FIELD OF ACTIVITY: TRADEMARKS, INDUSTRIAL DESIGNS AND GEOGRAPHICAL INDICATIONS

Arno ANIJALG	USTERVALL Ltd. Raekoja plats 16 51004 Tartu, Estonia P.O. Box 21 50002 Tartu, Estonia Phone: +372 744 1980 Fax: +372 744 1785 E-mail: anijalg@ustervall.ee Http://www.ustervall.ee German, Russian, Estonian	Uno JÄÄGER	Patent Agency Käosaar & Co Rüütli 51A 80010 Pärnu, Estonia Phone: +372 447 1021 Fax: +372 447 1001 GSM: +372 551 1758 E-mail: uno@estpak.ee Http://www.kaosaar.ee English, Finnish, Russian, Estonian
Aivo ARULA	Patent Agency Käosaar & Co Tähe Str. 94 50107 Tartu, Estonia Phone: +372 738 3051 Fax: +372 738 3055 E-mail: info@kaosaar.ee Http://www.kaosaar.ee English, Russian, Estonian	Sirje KAHU	USTERVALL Ltd. Raekoja plats 16 51004 Tartu, Estonia P.O. Box 21 50002 Tartu, Estonia Phone: +372 744 1980 Fax: +372 744 1785 E-mail: skahu@ustervall.ee Http://www.ustervall.ee English, Russian, Estonian
Martina BÖCKLER	Lasvet Ltd. P.O. Box 3136 10505 Tallinn, Estonia Phone: +372 640 6600 Fax: +372 640 6604 E-mail: lasvet@lasvet.ee Http://www.lasvet.ee English, Russian, Finnish, Estonian	Lembit KALEV	Patent Bureau ROOSILLA Ltd. Järveotsa Road 39-61 13520 Tallinn, Estonia Phone: +372 657 1722 +372 657 5381 Fax: +372 657 5381 GSM: +372 511 9951 E-mail: roosilla@roosilla.ee Http://www.roosilla.ee English, Russian, Estonian
Alla HÄMMALOV	Intels Ltd. Riia Str. 11-3 51010 Tartu, Estonia Phone: +372 742 0401 Fax: +372 742 0326 E-mail: intelses@estpak.ee English, Polish, Russian, Estonian	Urmas KAULER	Patendibüroo TURVAJA OÜ Liivalaia 22 10118 Tallinn, Estonia Phone: +372 640 3109 Fax: +372 640 3105 E-mail: kauler@turvaja.ee Http://www.turvaja.ee English, Russian, Finnish, Estonian
Juhan HÄMMALOV	Intels Ltd. Riia Str. 11-3 51010 Tartu, Estonia Phone: +372 742 0401 Fax: +372 742 0326 E-mail: intelses@estpak.ee English, German, Russian, Estonian		

- Urmas KERNU** **AAA Legal Services**
Tartu Road 16
10117 Tallinn, Estonia
P.O. Box 3926
10509 Tallinn, Estonia
Phone: +372 660 5910
 +372 660 5911
Fax: +372 660 5912
E-mail: aaa@aaa.ee
Http://www.aaa.ee
English, German, Finnish,
Russian, Estonian
- Marina KESSELMAN** **Kesna Ltd.**
Tedre Str. 77-52
10616 Tallinn, Estonia
Phone: +372 660 8068
Fax: +372 660 8069
E-mail: kesna@online.ee
English, German, Russian,
Estonian
- Ljubov KESSELMAN** **Kesna Ltd.**
Tedre Str. 77-52
10616 Tallinn, Estonia
Phone: +372 660 8068
Fax: +372 660 8069
E-mail: kesna@online.ee
English, Russian, Estonian
- Heinu KOITEL** **Patent- & Trademark Office
Koitel Ltd.**
Tartu Road 65
10115 Tallinn, Estonia
P.O. Box 1759
10902 Tallinn, Estonia
Phone: +372 603 3260
Fax: +372 603 3261
E-mail: koitel@koitel.ee
Http://www.koitel.ee
English, Finnish, Russian,
Estonian
- Raivo KOITEL** **Patent- & Trademark Office
Koitel Ltd.**
Tartu Road 65
10115 Tallinn, Estonia
P.O. Box 1759
10902 Tallinn, Estonia
Phone: +372 603 3260
Fax: +372 603 3261
E-mail: koitel@koitel.ee
Http://www.koitel.ee
English, Finnish, Russian,
Estonian
- Mart-Enn KOPPEL** Law Office Andrus Lillo
Rüütli 14, 51007 Tartu, Estonia
Phone: +372 730 3470
GSM: +372 525 0595
Fax: +372 730 3471
E-mail: info@koppelpb.com
Http://www.koppelpb.com
English, Russian, Finnish,
Estonian
- Heinrich KRUPP** **Patendibüroo TURVAJA OÜ**
Liivalaia 22
10118 Tallinn, Estonia
Phone: +372 640 3109
Fax: +372 640 3105
E-mail: turvaja@turvaja.ee
Http://www.turvaja.ee
German, Russian, Estonian
- Jüri KÄOSAAR** **Patent Agency Käosaar & Co**
Tähe Str. 94
50107 Tartu, Estonia
Phone: +372 738 3051
Fax: +372 738 3055
E-mail: info@kaosaar.ee
Http://www.kaosaar.ee
English, Russian, Estonian
- Reet MAASIKAMÄE** **Patent Bureau Kaitsepurus
Ltd.**
Mulla Str. 4-3
10611 Tallinn, Estonia
Phone: +372 673 9097
 +372 633 2798
Fax: +372 677 4844
E-mail: purus@online.ee
 purus@hotmail.ee
Http://www.hot.ee/purus/
English, Russian, Estonian
- Raivo MATSOO** **RM Hirvela Patent Bureau
Ltd**
Saku 15, 11314 Tallinn, Estonia
Phone: +372 614 0816
Fax: +372 614 0818
E-mail: hirvela@online.ee
English, Russian, Estonian
- Elle MELLIK** **AAA Legal Services**
Tartu Road 16
10117 Tallinn, Estonia
P.O. Box 3926
10509 Tallinn, Estonia
Phone: +372 660 5910
 +372 660 5911
Fax: +372 660 5912
E-mail: aaa@aaa.ee
Http://www.aaa.ee
English, Russian, Estonian

- Lembit MITT** **AAA Legal Services**
Tartu Road 16
10117 Tallinn, Estonia
P.O. Box 3926
10509 Tallinn, Estonia
Phone: +372 660 5910
 +372 660 5911
Fax: +372 660 5912
E-mail: aaa@aaa.ee
Http://www.aaa.ee
English, Russian, Estonian
- Ott MOORLAT** **Moorlat & Co Ltd.**
Patent Bureau
P.O. Box 723
12902 Tallinn, Estonia
Phone: +372 655 0450
 +372 654 2844
Fax: +372 654 2844
E-mail: ott.moorlat@moorlat.ee
Http://www.moorlat.ee
English, Russian, Estonian
- Anfia MORNA** **Patendibüroo TURVAJA OÜ**
Liivalaia 22
10118 Tallinn, Estonia
Phone: +372 640 3109
Fax: +372 640 3105
E-mail: morna@turvaja.ee
Http://www.turvaja.ee
English, Russian, Estonian
- Tõnu NELSAS** **AAA Legal Services**
Tartu Road 16
10117 Tallinn, Estonia
P.O. Box 3926
10509 Tallinn, Estonia
Phone: +372 660 5910
 +372 660 5911
Fax: +372 660 5912
E-mail: aaa@aaa.ee
Http://www.aaa.ee
English, Russian, Finnish,
Estonian
- Jüri OLT** **Patent Agency Käosaar & Co**
Tähe Str. 94
50107 Tartu, Estonia
Phone: +372 738 3051
Fax: +372 738 3055
E-mail: info@kaosaar.ee
Http://www.kaosaar.ee
English, German, Finnish,
Russian, Estonian
- Jaak OSTRAT**
- Villu PAVELTS**
- Lasvet Ltd.**
P.O. Box 3136
10505 Tallinn, Estonia
Phone: +372 640 6600
Fax: +372 640 6604
E-mail: lasvet@lasvet.ee
Http://www.lasvet.ee
English, German, Finnish,
Russian, Estonian
- Lasvet Ltd.**
P.O. Box 3136
10505 Tallinn, Estonia
Phone: +372 640 6600
Fax: +372 640 6604
E-mail: lasvet@lasvet.ee
Http://www.lasvet.ee
English, Finnish, Russian,
Estonian
- Anneli PUNGAS**
- Synest Ltd.**
P.O. Box 977
13402 Tallinn, Estonia
Phone: +372 660 9786
Fax: +372 660 9787
E-mail: anneli@synest.ee
English, German, Russian,
French, Finnish, Swedish,
Estonian
- Toom PUNGAS**
- Synest Ltd.**
P.O. Box 977
13402 Tallinn, Estonia
Phone: +372 660 9786
Fax: +372 660 9787
E-mail: toom@synest.ee
English, German, Finnish,
Russian, Estonian
- Kaie PUUR**
- Patent Agency Käosaar & Co**
Tähe Str. 94
50107 Tartu, Estonia
Phone: +372 738 3051
Fax: +372 738 3055
E-mail: info@kaosaar.ee
Http://www.kaosaar.ee
English, Russian, Estonian
- Tarmo ROSMAN**
- Rosman and Partners Ltd.**
P.O. Box 652
12602 Tallinn, Estonia
Phone: +372 656 1450
Fax: +372 656 1450
E-mail: tarman@cc.ttu.ee
German, English, Hungarian,
Russian, Estonian

- Arvo SALUMÄE** **AMENDE Patent Agency Ltd.**
Raua 65, 10152 Tallinn, Estonia
Phone: +372 648 6125
Fax: +372 641 0174
E-mail: amende@hot.ee
English, German, Finnish,
Russian, Estonian
- Enn URGAS** **Patendibüroo TURVAJA OÜ**
Liivalaia 22
10118 Tallinn, Estonia
Phone: +372 640 3109
Fax: +372 640 3105
E-mail: urgas@turvaja.ee
Http://www.turvaja.ee
English, Russian, Estonian
- Harald TEHVER** **Patendibüroo TURVAJA OÜ**
Liivalaia 22
10118 Tallinn, Estonia
Phone: +372 640 3109
Fax: +372 640 3105
E-mail: tehver@turvaja.ee
Http://www.turvaja.ee
English, German, Russian,
Estonian
- Juta-Maris UUSTALU** **Lasvet Ltd.**
P.O. Box 3136
10505 Tallinn, Estonia
Phone: +372 640 6600
Fax: +372 640 6604
E-mail: lasvet@lasvet.ee
Http://www.lasvet.ee
English, Russian, Estonian
- Olga TREUFELDT** **Patendibüroo TURVAJA OÜ**
Liivalaia 22
10118 Tallinn, Estonia
Phone: +372 640 3109
Fax: +372 640 3105
E-mail: olga@turvaja.ee
Http://www.turvaja.ee
English, Russian, Estonian

**RIIKIDE, TEISTE ÜHENDUSTE JA VALITSUSTEVAAHELISTE
ORGANISATSIOONIDE KOODID**

AD	Andorra	DM	Dominica	IT	Itaalia	PL	Poola
AE	Araabia	DO	Dominikaani	JM	Jamaica	PT	Portugal
	Ühendemiraadid		Vabariik	JO	Jordaania	PW	Belau
AF	Afganistan	DZ	Alžeeria	JP	Jaapan	PY	Paraguay
AG	Antigua ja Barbuda	EA	Euraasia	KE	Kenya	QA	Katar
AI	Anguilla		Patendiorganisat-	KG	Kõrgõzstan	RO	Rumeenia
AL	Albaania		sioon (EAPO)	KH	Kambodža	RU	Venemaa
AM	Armeenia	EC	Ecuador	KI	Kiribati	RW	Rwanda
AN	Hollandi Antillid	EE	Eesti	KM	Komoorid	SA	Saudi Araabia
AO	Angola	EG	Egiptus	KN	Saint Kitts ja Nevis	SB	Saalomoni Saared
AP	Aafrika Regionaalne	EH	Lääne-Sahara	KP	Põhja-Korea	SC	Seišellid
	Tööstusomandi Orga-	EM	Siseturu	KR	Lõuna-Korea	SD	Sudaan
	nisatsioon (ARIPO)		Ühtlustamise	KW	Kuveit	SE	Rootsi
AR	Argentina		Amet (kaubamärgid	KY	Kaimanisaared	SG	Singapur
AS	Ameerika Samoa		ja tööstusdisaini-	KZ	Kasahstan	SH	Saint Helena
AT	Austria		lahendused) (OHIM)	LA	Laos	SI	Sloveenia
AU	Austraalia	EP	Euroopa	LB	Liibanon	SK	Slovakkia
AW	Aruba		Patendiamet (EPO)	LC	Saint Lucia	SL	Sierra Leone
AZ	Aserbaidžaan	ER	Eritrea	LI	Liechtenstein	SM	San Marino
BA	Bosnia ja	ES	Hispaania	LK	Sri Lanka	SN	Senegal
	Hertsegovina	ET	Etiopia	LR	Libeeria	SO	Somaalia
BB	Barbados	FI	Soome	LS	Lesotho	SR	Suriname
BD	Bangladesh	FJ	Fidži	LT	Leedu	ST	São Tomé ja Príncipe
BE	Belgia	FK	Falklandi (Malviini)	LU	Luksemburg	SV	El Salvador
BF	Burkina Faso		saared	LV	Läti	SY	Süüria
BG	Bulgaaria	FM	Mikroneesia	LY	Liibüa	SZ	Svaasimaa
BH	Bahrein	FO	Fääri saared	MA	Maroko	TC	Turks ja Caicos
BI	Burundi	FR	Prantsusmaa	MC	Monaco	TD	Tšaad
BJ	Benin	GA	Gabon	MD	Moldova	TG	Togo
BM	Bermuda	GB	Ühendkuningriik	MG	Madagaskar	TH	Tai
BN	Brunei		(Suurbritannia)	MH	Marshalli Saared	TJ	Tadžikistan
BO	Boliivia	GD	Grenada	MK	Makedoonia	TM	Türkmenistan
BR	Brasiilia	GE	Gruusia	ML	Mali	TN	Tuneesia
BS	Bahama	GH	Ghana	MM	Myanmar (Birma)	TO	Tonga
BT	Bhutan	GI	Gibraltar	MN	Mongoolia	TL	Ida-Timor
BV	Bouvet' saar	GL	Gröönimaa	MO	Macao	TR	Türgi
BW	Botswana	GM	Gambia	MP	Põhja-Mariaanid	TT	Trinidad ja Tobago
BX	Beneluxi	GN	Guinea	MR	Mauritaania	TV	Tuvalu
	Kaubamärgiamet	GQ	Ekvatoriaal-Guinea	MS	Montserratt	TW	Taiwan (Hiina provints)
	(BBM) ja Beneluxi	GR	Kreeka	MT	Malta	TZ	Tansaania
	Tööstusdisainilahen-	GS	Lõuna-Georgia ja	MU	Mauritius	UA	Ukraina
	duste Amet (BBDM)		Lõuna-Sandwichi	MV	Maldiivid	UG	Uganda
			saared	MW	Malawi	US	Ameerika
BY	Valgevene			MX	Mehhiko		Ühendriigid
BZ	Belize	GT	Guatemala	MY	Malaisia	UY	Uruguay
CA	Kanada	GW	Guinea-Bissau	MZ	Mosambiik	UZ	Usbekistan
CF	Kesk-Aafrika	GY	Guyana	NA	Namiibia	VA	Vatikan (Püha Tool)
	Vabariik	HK	Hongkong	NE	Niger	VC	Saint Vincent ja
CG	Kongo	HN	Honduras	NG	Nigeeria		Grenadiinid
CH	Šveits	HR	Horvaatia	NI	Nicaragua	VE	Venezuela
CI	Côte d'Ivoire	HT	Haiti	NL	Holland	VG	Neitsisaared
CK	Cooki saared	HU	Ungari	NO	Norra	VN	Vietnam
CL	Tšiili	IB	Ülemaailmse	NP	Nepal	VU	Vanuatu
CM	Kamerun		Intellektuaalomandi	NR	Nauru	WO	Ülemaailmne
CN	Hiina		Organisatsiooni	NZ	Uus-Meremaa		Intellektuaalomandi
CO	Kolumbia		(WIPO) Rahvus-	OA	Aafrika Intellektuaal-		Organisatsioon
CR	Costa Rica		vaheline Büroo		omandi Organisat-		(WIPO) (Rahvus-
CS	Serbia ja Montenegro	ID	Indoneesia		sioon (OAPI)		vaheline Büroo)
CU	Kuuba	IE	Iiri	OM	Omaan	WS	Samoa
CV	Cabo Verde	IL	Iisrael	PA	Panama	YE	Jeemen
CY	Küpros	IM	Man'i saar	PE	Peruu	ZA	Lõuna-Aafrika Vabariik
CZ	Tšehhi	IN	India	PG	Paapua Uus-Guinea	ZM	Sambia
DE	Saksamaa	IQ	Iraak	PH	Filipiinid	ZR	Zaire
DJ	Djibouti	IR	Iraan	PK	Pakistan	ZW	Zimbabwe
DK	Taani	IS	Island				