



EESTI VABARIIK

**T** **EESTI**  
**TÖÖSTUSDISAINI-**  
**LAHENDUSE LEHT**



PATENDIAMETI AMETLIK VÄLJAANNE

**2**  
**2003**  
TALLINN



ISSN 1406-376X

EESTI VABARIIK

# T

**T** **EESTI**  
**TÖÖSTUSDISAINI-**  
**LAHENDUSE LEHT**

**PATENDIAMETI  
AMETLIK VÄLJAANNE**

**VI aastakäik**

Käesolevas numbris  
esitatud andmed  
loetakse avaldatuks  
**15. mail 2003. a.**

**2**  
**2003**  
MAI  
TALLINN

Eesti Tööstusdisainilahenduse Lehte antakse välja tööstusdisaini kaitse seaduse (jõustunud 11.01.1998) alusel.  
The Estonian Industrial Design Gazette is the official publication of the Estonian Patent Office.  
Published under Industrial Design Protection Law of the Republic of Estonia (coming into force 11 January 1998).  
Date of publication of the data presented in this issue - 15 May 2003.

Patendiameti  
infoosakond  
Toompuiestee 7  
15041 Tallinn  
Tel. 627 7907  
Faks 627 7943  
E-post: [Info@epa.ee](mailto:Info@epa.ee)

The Information Department  
of the Estonian Patent Office  
Toompuiestee 7  
15041 Tallinn, ESTONIA  
Phone (372) 627 7907  
Fax (372) 627 7943  
E-mail: [Info@epa.ee](mailto:Info@epa.ee)

#### Levitaja

Eesti Patendiraamatukogu  
Olevimägi 8/10  
10123 Tallinn  
Tel. 641 1248  
Faks 641 1018  
E-post: [patent@patentlib.ee](mailto:patent@patentlib.ee)

#### Distributor

Estonian Patent Library  
Olevimägi 8/10  
10123 Tallinn, ESTONIA  
Phone (372) 641 1248  
Fax (372) 641 1018  
E-mail: [patent@patentlib.ee](mailto:patent@patentlib.ee)

## SISUKORD

Andmete identifitseerimise rahvusvahelised numberkoodid (INID-koodid) . . . . .	4
I. REGISTREERITUD TÖÖSTUSDISAINILAHENDUSED . . . . .	5
II. TÖÖSTUSDISAINILAHENDUSE REGISTREERINGU KEHTIVUSE PIKENDAMINE . . . . .	76
III. TÖÖSTUSDISAINILAHENDUSE REGISTREERINGU ANDMETE MUUTMINE . . . . .	76
IV. TÖÖSTUSDISAINILAHENDUSE OMANIKU ÕIGUSTE KASUTUSVALDUSSE ANDMINE . . . . .	-
V. TÖÖSTUSDISAINILAHENDUSE REGISTREERINGU KUSTUTAMINE . . . . .	-
VI. TÖÖSTUSDISAINILAHENDUSE TUNNISTUSE DUPLIKAADI VÄLJASTAMINE . . . . .	-
VII. LOENDID . . . . .	77
Registreeritud tööstusdisainilahenduste süstemaatiline loend . . . . .	77
Registreeritud tööstusdisainilahenduste registreerimistaotluste numbriline loend . . . . .	78
VIII. TÖÖSTUSDISAINIALASED ÕIGUSAKTID JA MUU INFO . . . . .	79
Riiklikus patendivolnike registris registreeritud patendivolnike nimekiri . . . . .	79
Riikide, teiste ühenduste ja valitsustevaheliste organisatsioonide koodid . . . . .	86

## CONTENTS

Internationally Agreed Numbers for the Identification of Data (INID Codes) . . . . .	4
I. REGISTERED INDUSTRIAL DESIGNS . . . . .	5
II. RENEWAL OF TERM OF INDUSTRIAL DESIGN . . . . .	76
III. CHANGE IN DATA RELATING TO THE REGISTRATION OF INDUSTRIAL DESIGN . . . . .	76
IV. TRANSFER OF RIGHTS OF PROPRIETOR OF INDUSTRIAL DESIGN INTO USUFRUCT. . . . .	-
V. DELETION OF INDUSTRIAL DESIGN REGISTRATION . . . . .	-
VI. ISSUE OF A DUPLICATE OF INDUSTRIAL DESIGN CERTIFICATE . . . . .	-
VII. LISTS . . . . .	77
Systematic List of Registered Industrial Designs . . . . .	77
Numerical List of Registration Applications of Registered Industrial Designs . . . . .	78
VIII. LEGAL ACTS AND INFORMATION. . . . .	79
List of Patent Attorneys, Registered in the Estonian State Register of Patent Attorneys . . . . .	82
List of Codes of States, Other Entities and Intergovernmental Organizations . . . . .	86

**ANDMETE IDENTIFITSEERIMISE  
RAHVUSVAHELISED NUMBERKOODID  
(INID-KOODID)**

**INTERNATIONALLY AGREED NUMBERS FOR  
THE IDENTIFICATION OF DATA  
(INID CODES)**

(11) Registreeringu number	(11) Number of the Registration
(15) Registreerimise kuupäev	(15) Date of the Registration
(18) Registreeringu kehtivuse lõppemise kuupäev	(18) Expected expiration date of the registration
(21) Registreerimistaotluse number	(21) Application Number
(22) Registreerimistaotluse esitamise kuupäev	(22) Application Filing Date
(24) Registreeringu kehtivuse alguse kuupäev	(24) Date from which the Industrial Design Right Has Effected
(28) Variantide arv	(28) Number of Industrial Designs Included in the Application
(30) Prioriteet	(30) Priority
(51) Rahvusvahelise klassifikatsiooni klassi ja alaklassi number	(51) International Classification for Industrial Designs (class and subclass of the Locarno Classification)
(54) Tööstusdisainilahenduse nimetus	(54) Title of the Industrial Design
(55) Tööstusdisainilahenduse reproduktsioon	(55) Reproduction of the Industrial Design
(72) Tööstusdisainilahenduse autor(id)	(72) Author(s) of Industrial Design
(73) Tööstusdisainilahenduse omanik(ud)	(73) Proprietor(s) of Industrial Design
(74) Patendivolinik või ühine esindaja	(74) Patent Attorney or Common Representative

# **I. REGISTREERITUD TÖÖSTUSDISAINILAHENDUSED**

(Avaldatakse tööstusdisaini kaitse seaduse § 58 lõike 8 alusel)  
Patendiamet ei ole kontrollinud tööstusdisainilahenduse uudsust ja eristatavust tulenevalt  
tööstusdisaini kaitse seaduse § 31 lõike 2 punktist 1

(11) Registreeringu number:	<b>00749</b>	
(15) Registreerimise kuupäev:	03.02.2003	(51) Klass: <b>09-03</b>
(21) Taotluse number:	D2002 00113	
(22) Esitamise kuupäev:	07.10.2002	
(24) Registreeringu kehtivuse alguse kuupäev:	07.10.2002	
(28) Variantide arv:	1	
(72) Autor:	Aina Mälmeistare, Anniņmuižas Bulvāris 64-51, Rīga, LV-1067, LV	
(73) Omanik:	SIA "STORA ENSO PACKAGING", Tiraines Street 5, Rīga, LV-1058, LV	
(74) Patendivolinik või ühine esindaja:	Tarmo Rosman	

(54) Nimetus: **Munade pakend**

(55) Reproduktsoon:

00749-01

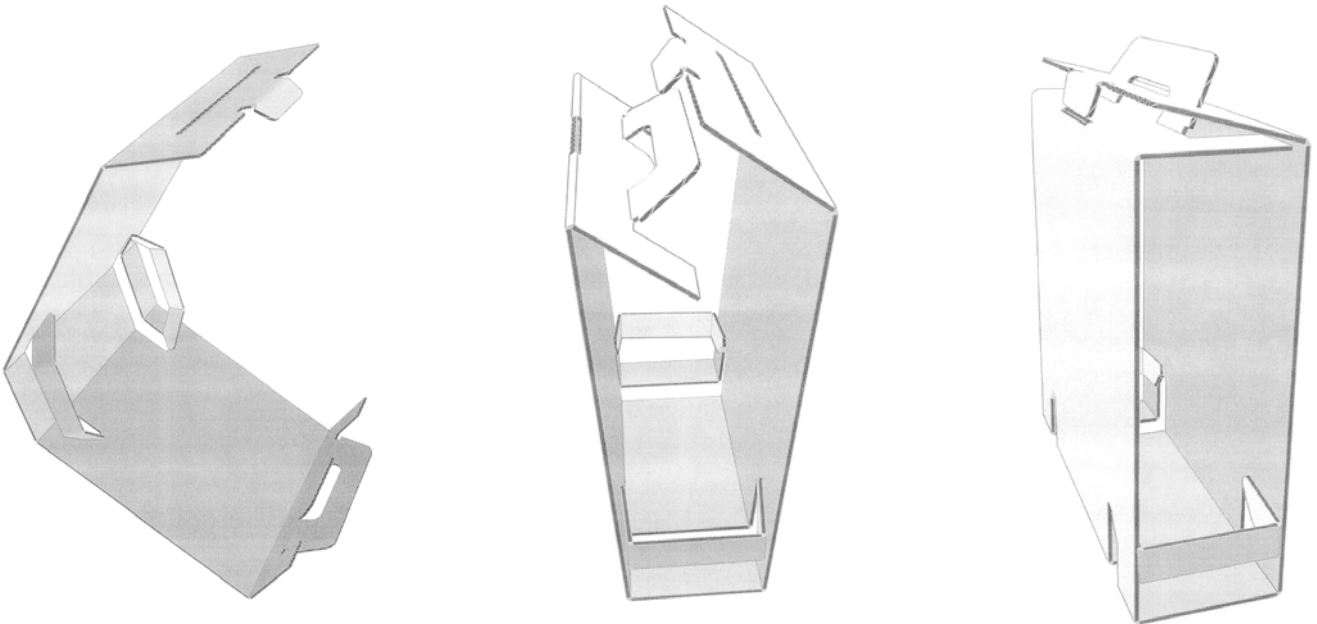

- (11) Registreeringu number: **00750**
- (15) Registreerimise kuupäev: 03.02.2003 (51) Klass: **13-02**
- (21) Taotluse number: D2002 00139
- (22) Esitamise kuupäev: 17.12.2002
- (24) Registreeringu kehtivuse alguse kuupäev: 17.12.2002
- (28) Variantide arv: 1
- (30) Prioriteediandmed: M20020369, 17.06.2002, FI
- (72) Autor: Valtteri Eroma, Itätuulenkuja 5 B 31, FIN-02100 Espoo, FI  
Sami Lehtovaara, Pakkarinkatu 5 as 19, 20100 Turku, FI  
Nokia Corporation, Keilalahdentie 4, FIN-02150 Espoo, FI
- (73) Omanik: Nokia Corporation, Keilalahdentie 4, FIN-02150 Espoo, FI
- (74) Patendivolinik või ühine esindaja: Aivo Arula

(54) Nimetus: **Lauapealne laadija**

(55) Reproduktsoon:

00750-01





- (11) Registreeringu number: **00751**
- (15) Registreerimise kuupäev: 03.02.2003 (51) Klass: **09-01**
- (21) Taotluse number: D2002 00146
- (22) Esitamise kuupäev: 30.12.2002
- (24) Registreeringu kehtivuse alguse kuupäev: 30.12.2002
- (28) Variantide arv: 11
- (30) Prioriteediandmed: 40205280.3, 28.06.2002, DE - variant 1-7  
40206068.7, 24.07.2002, DE - variant 8-9  
40207991.4, 24.09.2002, DE - variant 10-11
- (72) Autor: Giulano Dell'Orto, via Vegevano 41, 20144 Milano, IT  
Meryll Usseglio, via Vegevano 41, 20144 Milano, IT  
Andrea Rogora, via Vegevano 41, 20144 Milano, IT  
Andrea Bandiera, via Vegevano 41, 20144 Milano, IT
- (73) Omanik: Henkel KGaA, Henkelstrasse 67, 40589 Düsseldorf, DE
- (74) Patendivolinik või ühine esindaja: Raivo Matsoo
- (54) Nimetus: **Pudel**
- (55) Reproduktsoon:

00751-01

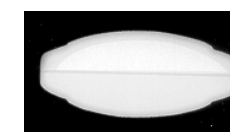
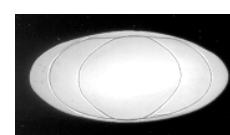
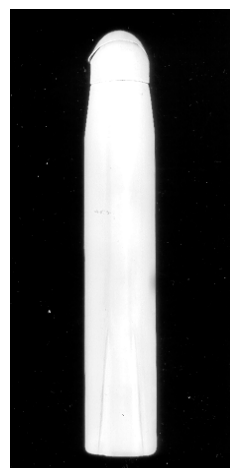
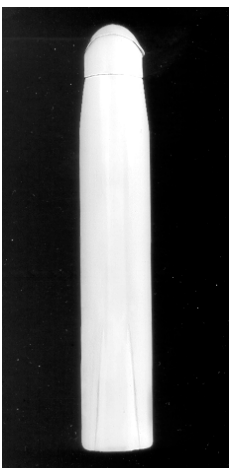
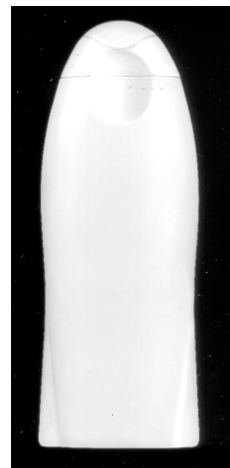
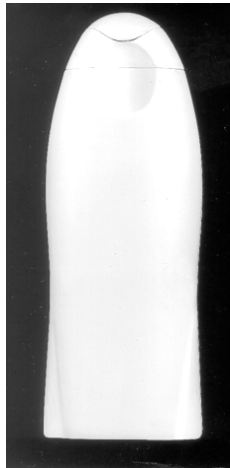
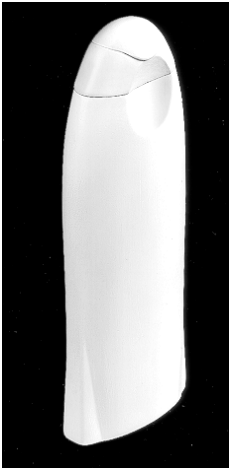

00751-02

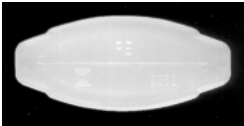
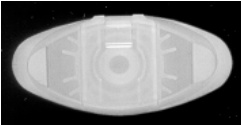
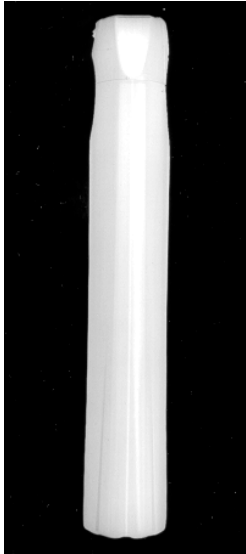
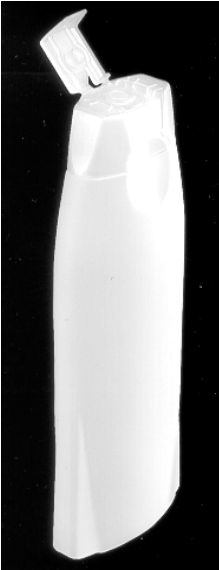

00751-03

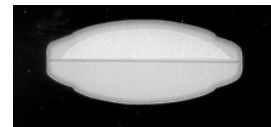
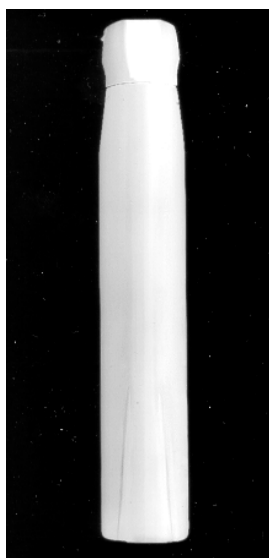
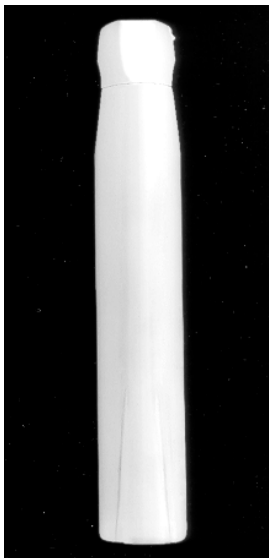
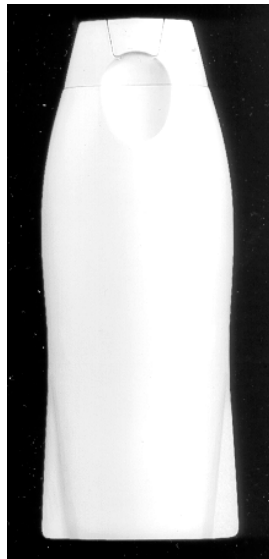

00751-04



00751-05



00751-06

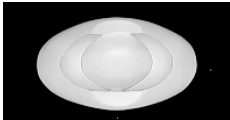
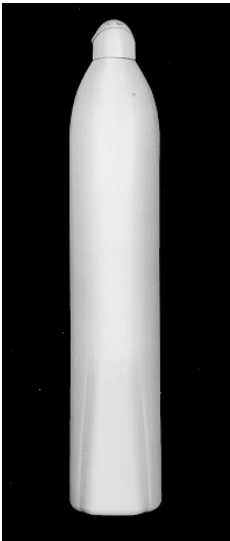
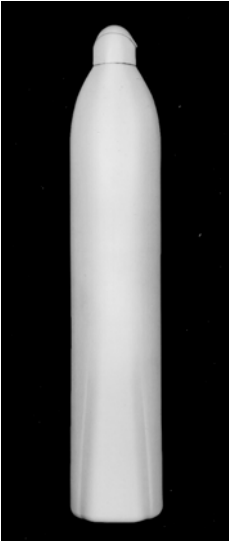
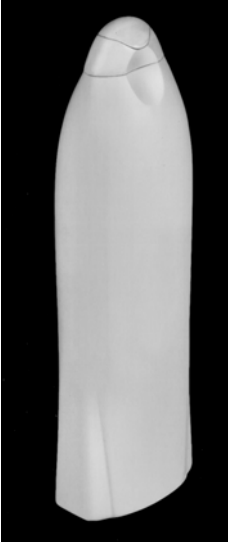

00751-07

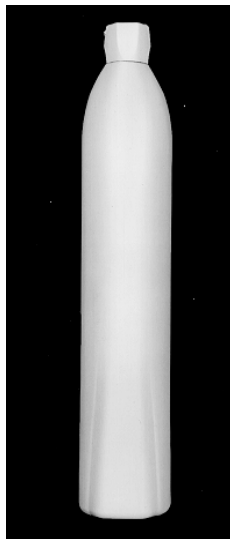
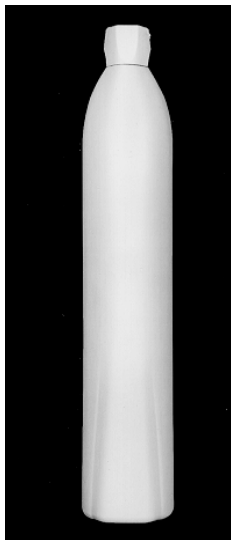
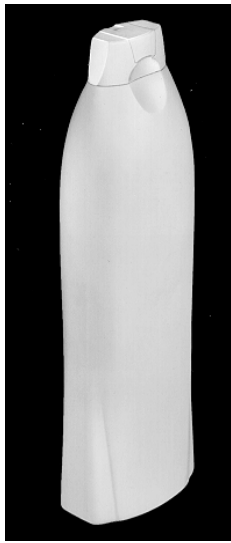

00751-08





00751-09

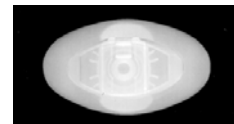
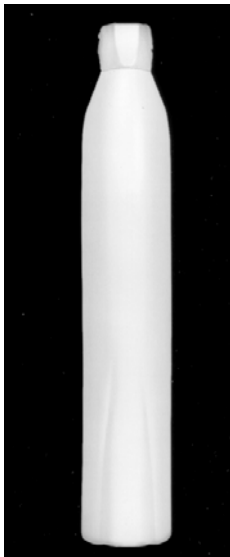
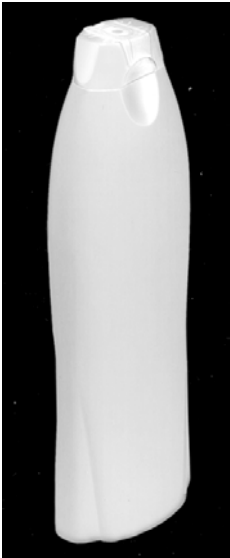

00751-10

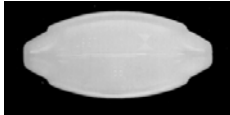
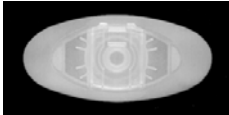
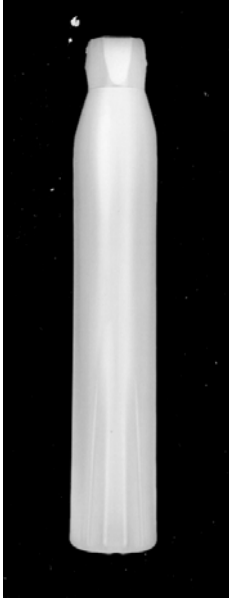
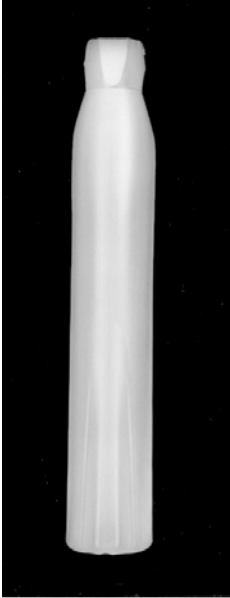
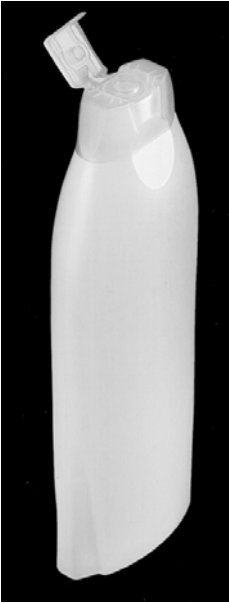

00751-11

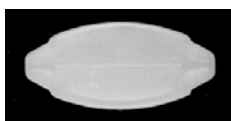
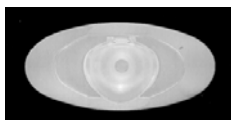
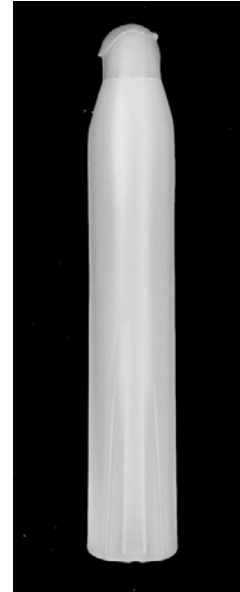
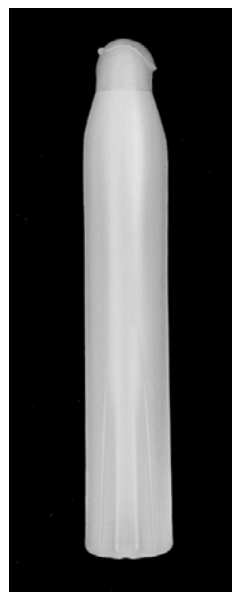
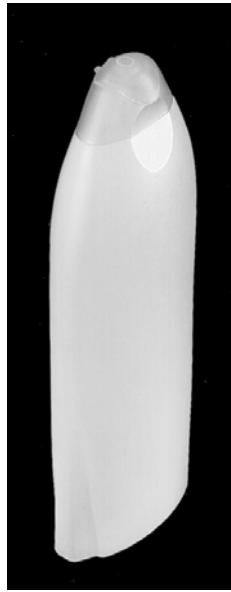
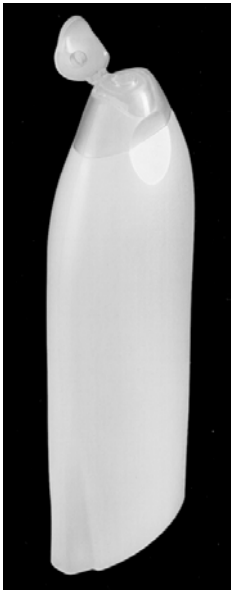

(11) Registreeringu number: **00752**

(15) Registreerimise kuupäev: 03.02.2003

(51) Klass: **06-04; 06-05**

(21) Taotluse number: D2003 00001

(22) Esitamise kuupäev: 07.01.2003

(24) Registreeringu kehtivuse  
alguse kuupäev: 07.01.2003

(28) Variantide arv: 3

(72) Autor: Ivari Männi, Joa 2, 10127 Tallinn, EE

(73) Omanik: OÜ Woodman Trade, Neeme, Jõelähtme vald, 74203 Harju maakond, EE

(74) Patendivolinik või ühine esindaja: Ott Moorlat

(54) Nimetus: **Komplekteeritav riid**

(55) Reproduktsioon:

00752-01

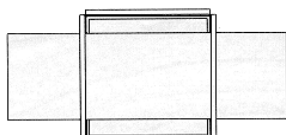
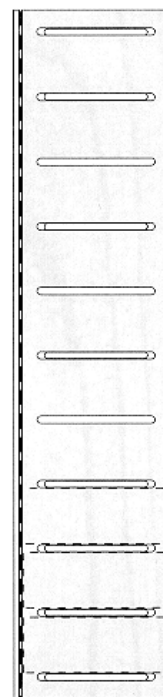
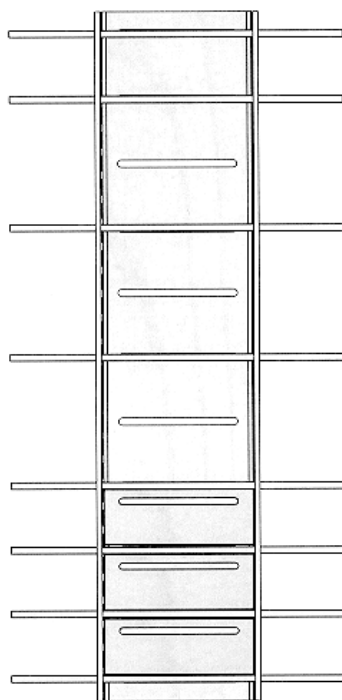
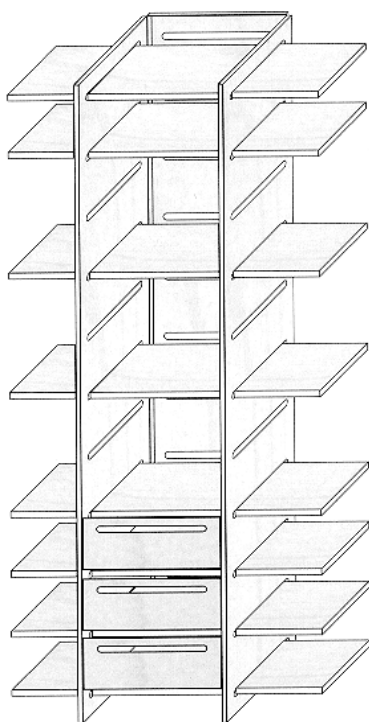

00752-02

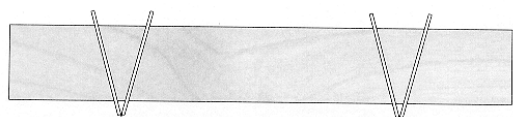
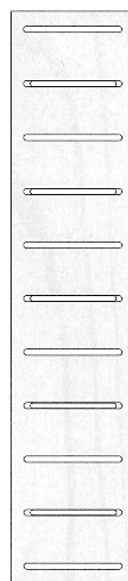
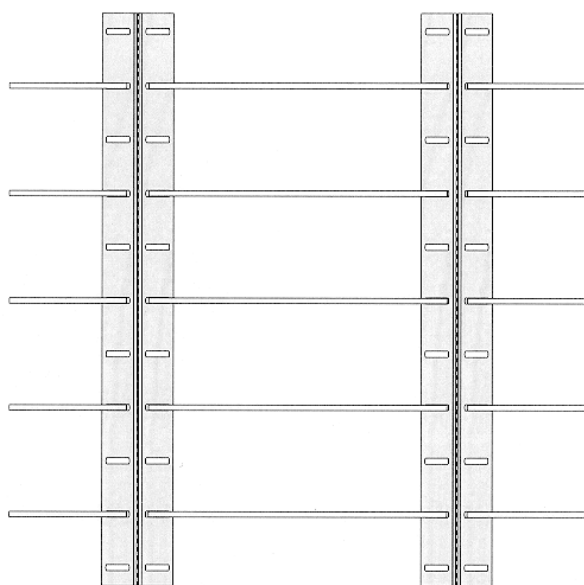

00752-03

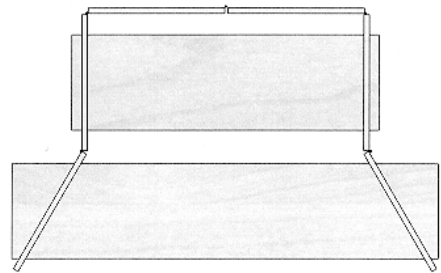
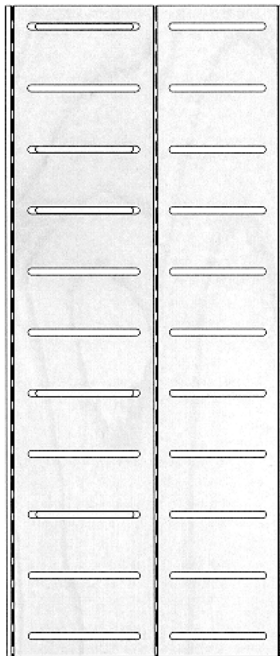
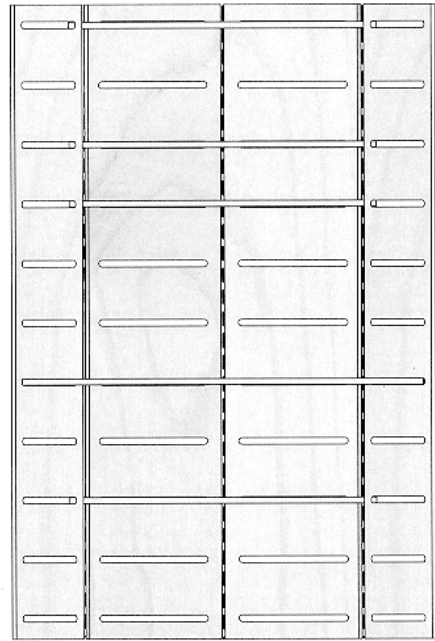
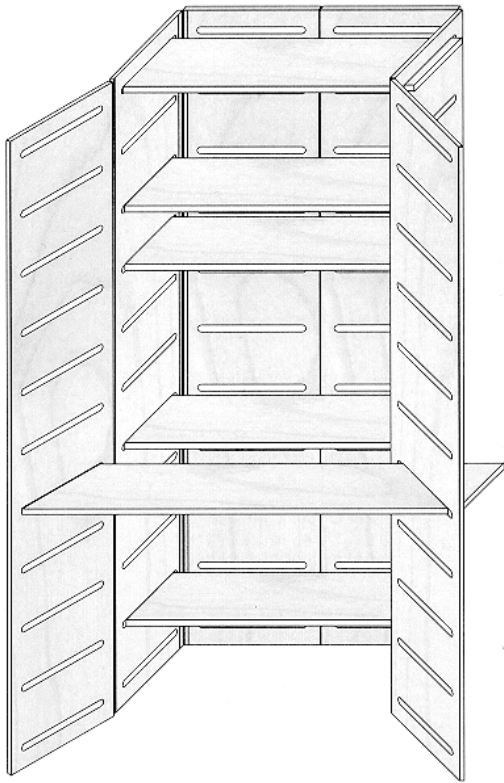

- (11) Registreeringu number: **00753**
- (15) Registreerimise kuupäev: 12.02.2003 (51) Klass: **09-07**
- (21) Taotluse number: D2003 00002
- (22) Esitamise kuupäev: 10.01.2003
- (24) Registreeringu kehtivuse  
alguse kuupäev: 10.01.2003
- (28) Variantide arv: 1
- (72) Autor: Viktor Vladimirovich Krõlov, Fergansky pr., d. 4, kv. 468, 109507 Moskva, RU  
Igor Sergejevich Nikitin, Domodedovskaya ul., d. 20, korp. 3, kv. 276,  
115551 Moskva, RU
- (73) Omanik: Kinnine aktsiaselts INZHENERNIJ PROMISHLIENNIJ KONTSERN "STRAZH",  
Komsomolskij prospekt 16/2, 119021 Moskva, RU
- (74) Patendivolinik või ühine esindaja: Heinu Koitel
- (54) Nimetus: **Lukustus- ja plommimisseadis "KLEŠTŠ-60SC"**
- (55) Reproduktsoon:

00753-01

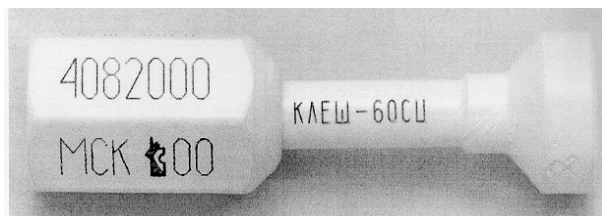

- (11) Registreeringu number: **00754**
- (15) Registreerimise kuupäev: 12.02.2003 (51) Klass: **09-07**
- (21) Taotluse number: D2003 00003
- (22) Esitamise kuupäev: 10.01.2003
- (24) Registreeringu kehtivuse alguse kuupäev: 10.01.2003
- (28) Variantide arv: 1
- (72) Autor: Viktor Vladimirovich Krõlov, Fergansky pr., d. 4, kv. 468, 109507 Moskva, RU  
Igor Sergejevich Nikitin, Domodedovskaya ul., d. 20, korp. 3, kv. 276, 115551 Moskva, RU
- (73) Omanik: Kinnine aktsiaselts INZHENERNIJ PROMISHLENNIJ KONTSERN "STRAZH", Komsomolskij prospekt 16/2, 119021 Moskva, RU
- (74) Patendivolinik või ühine esindaja: Heinu Koitel
- (54) Nimetus: **Lukustus- ja plommimisseadis "SPRUT-UNIVERSAAL"**
- (55) Reproduktsoon:

00754-01

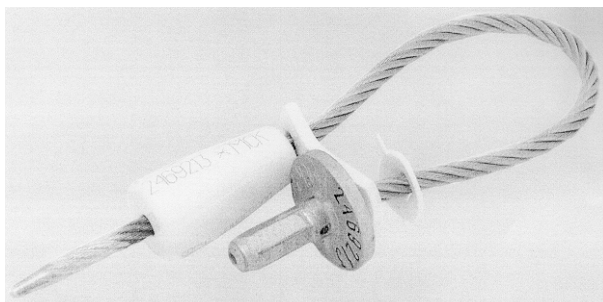



- (11) Registreeringu number: **00755**
- (15) Registreerimise kuupäev: 12.02.2003 (51) Klass: **09-07**
- (21) Taotluse number: D2003 00004
- (22) Esitamise kuupäev: 10.01.2003
- (24) Registreeringu kehtivuse  
alguse kuupäev: 10.01.2003
- (28) Variantide arv: 1
- (72) Autor: Igor Sergejevich Nikitin, Domodedovskaya ul., d. 20, korp. 3, kv. 276,  
115551 Moskva, RU  
Sergey Fyodorovich Gornov, Kluchevaya ul., d. 12, korp. 1, kv. 12,  
115612 Moskva, RU
- (73) Omanik: Kinnine aktsiaselts INZHENERNIJ PROMISHLENNIJ KONTSERN "STRAZH",  
Komsomolskij prospekt 16/2, 119021 Moskva, RU
- (74) Patendivolinik või ühine esindaja: Heinu Koitel
- (54) Nimetus: **Lukustus- ja plommimisseadis "SKAT"**
- (55) Reproduktsoon:

00755-01

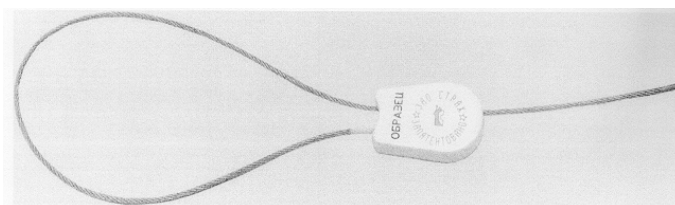

- (11) Registreeringu number: **00756**
- (15) Registreerimise kuupäev: 12.02.2003 (51) Klass: **09-07**
- (21) Taotluse number: D2003 00005
- (22) Esitamise kuupäev: 13.01.2003
- (24) Registreeringu kehtivuse  
alguse kuupäev: 13.01.2003
- (28) Variantide arv: 1
- (72) Autor: Viktor Vladimirovich Krõlov, Fergansky pr., d. 4, kv. 468, 109507 Moskva, RU  
Valery Dmitrievich Gudov, mikrorayon Pavlino, d. 19, kv. 97,  
g. Zheleznodorozhnij, 143960, Moskovskaya obl., RU  
Vladimir Mikhailovich Sinitsin, Mitnaya ul., d. 44, kv. 49, 113162 Moskva, RU
- (73) Omanik: Kinnine aktsiaselts INZHENERNIJ PROMISHLENNIJ KONTSERN "STRAZH",  
Komsomolskij prospekt 16/2, 119021 Moskva, RU
- (74) Patendivolinik või ühine esindaja: Heinu Koitel
- (54) Nimetus: **Lukustus- ja plommimisseadis "SPRUT-777"**
- (55) Reproduktsoon:

00756-01

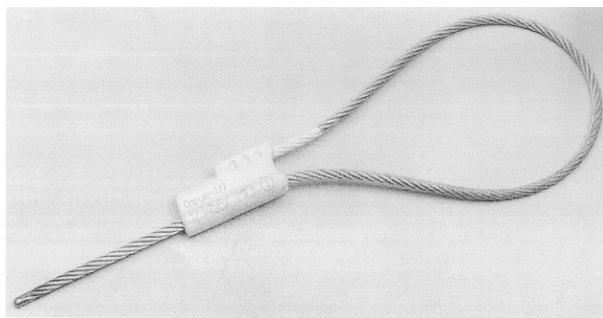

(11) Registreeringu number: **00757**

(15) Registreerimise kuupäev: 12.02.2003

(51) Klass: **19-02; 20-03**

(21) Taotluse number: D2003 00008

(22) Esitamise kuupäev: 24.01.2003

(24) Registreeringu kehtivuse alguse kuupäev: 24.01.2003

(28) Variantide arv: 1

(72) Autor: *Autori andmeid ei avalikustata*

(73) Omanik: OÜ Mainos Grupp, Niidu 3, 80040 Pärnu, EE

(54) Nimetus: **Reklaamkirjutusalus**

(55) Reproduktsoon:

00757-01

**PÄRNU KIRJUTUSALUS 2003**

The advertisement grid includes the following sections and ads:

- Top Row:** Peugeot, GLASKEK, PÄRNU OSAKOND, SCANIA, Mazda.
- Second Row:** Lincon, VIRAAM, PLASTO, MDM-AIHO, SALACIA, GUSTAF, DOLG, FEFYCA.
- Third Row:** OBER HAUS, SÄREKALU, LIMA- JA PIMATOODETE TOOTMINE, Pretty, JART KONSULT, CARGOMAX, FLEXOIL.
- Bottom Row:** ELS EXPRESS, KULTUR, EHTUSTOORIST, PAKT-RENT, TOORHISTALACHUTUS, VAATA!, BERTILON, AS SEVALAN.

Central graphic: **1182** and **20555** with a map of Pärnu.

- (11) Registreeringu number: **00758**
- (15) Registreerimise kuupäev: 20.02.2003 (51) Klass: **10-02**
- (21) Taotluse number: D2002 00126
- (22) Esitamise kuupäev: 09.12.2002
- (24) Registreeringu kehtivuse alguse kuupäev: 09.12.2002
- (28) Variantide arv: 1
- (30) Prioriteediandmed: 3009082, 29.11.2002, GB
- (72) Autor: Thierry de Baschmakoff, 10, Rue Chabanais, 75002 Paris, FR
- (73) Omanik: Asprey Holdings Limited, 167 New Bond Street, London W1S 4AR, GB
- (74) Patendivolinik või ühine esindaja: Lembit Mitt
- (54) Nimetus: **Automaatkäekell**
- (55) Reproduktsoon:

00758-01

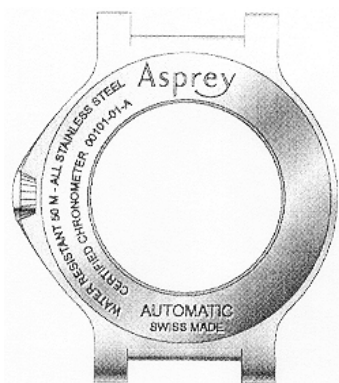
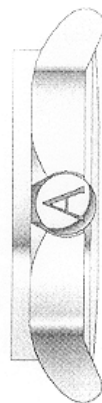

- (11) Registreeringu number: **00759**
- (15) Registreerimise kuupäev: 20.02.2003 (51) Klass: **10-02**
- (21) Taotluse number: D2002 00127
- (22) Esitamise kuupäev: 09.12.2002
- (24) Registreeringu kehtivuse alguse kuupäev: 09.12.2002
- (28) Variantide arv: 1
- (30) Prioriteediandmed: 3009081, 29.11.2002, GB
- (72) Autor: Thierry de Baschmakoff, 10, Rue Chabanais, 75002 Paris, FR
- (73) Omanik: Asprey Holdings Limited, 167 New Bond Street, London W1S 4AR, GB
- (74) Patendivolinik või ühine esindaja: Lembit Mitt
- (54) Nimetus: **Naiste käekell**
- (55) Reproduksioon:

00759-01

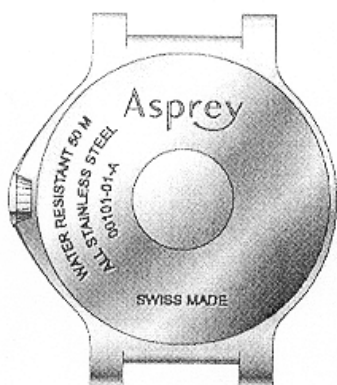

- (11) Registreeringu number: **00760**
- (15) Registreerimise kuupäev: 20.02.2003 (51) Klass: **10-02**
- (21) Taotluse number: D2002 00128
- (22) Esitamise kuupäev: 09.12.2002
- (24) Registreeringu kehtivuse alguse kuupäev: 09.12.2002
- (28) Variantide arv: 1
- (30) Prioriteediandmed: 3009080, 29.11.2002, GB
- (72) Autor: Thierry de Baschmakoff, 10, Rue Chabanais, 75002 Paris, FR
- (73) Omanik: Asprey Holdings Limited, 167 New Bond Street, London W1S 4AR, GB
- (74) Patendivolinik või ühine esindaja: Lembit Mitt
- (54) Nimetus: **Kronomeetiline käekell**
- (55) Reproduktsoon:

00760-01

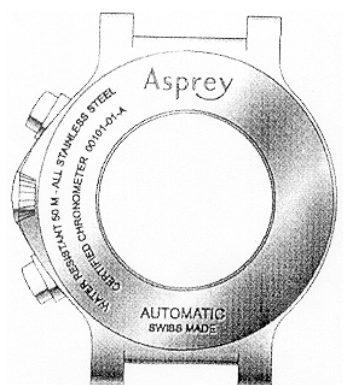
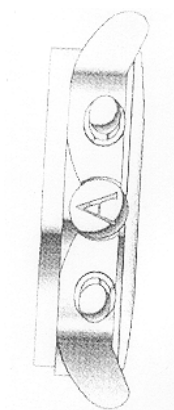
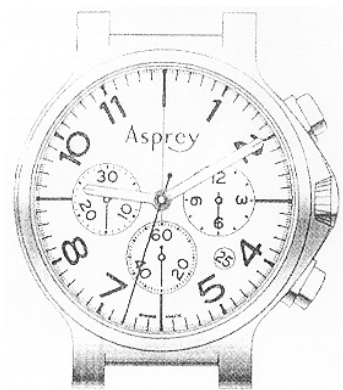

- (11) Registreeringu number: **00761**
- (15) Registreerimise kuupäev: 20.02.2003 (51) Klass: **10-02**
- (21) Taotluse number: D2002 00129
- (22) Esitamise kuupäev: 09.12.2002
- (24) Registreeringu kehtivuse alguse kuupäev: 09.12.2002
- (28) Variantide arv: 1
- (30) Prioriteediandmed: 3009079, 29.11.2002, GB
- (72) Autor: Thierry de Baschmakoff, 10, Rue Chabanais, 75002 Paris, FR
- (73) Omanik: Asprey Holdings Limited, 167 New Bond Street, London W1S 4AR, GB
- (74) Patendivolinik või ühine esindaja:

(54) Nimetus: **8 päeva käekell**

(55) Reproduktsoon:

00761-01

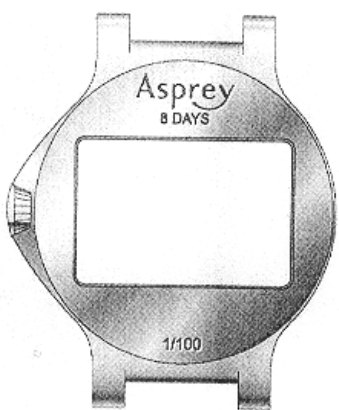
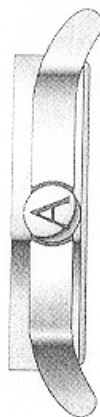

- (11) Registreeringu number: **00762**
- (15) Registreerimise kuupäev: 11.03.2003 (51) Klass: **06-09**
- (21) Taotluse number: D2003 00007
- (22) Esitamise kuupäev: 15.01.2003
- (24) Registreeringu kehtivuse alguse kuupäev: 15.01.2003
- (28) Variantide arv: 1
- (72) Autor: Thomas L. Borcharding, 408 Thorntree Lake Court, Eureka, Missouri, US  
Thomas J. Nurdin, 1 Sunny Slope Drive, Belleville, Illinois, US  
David K. Parsons, 229 Bourdelais Drive, Swansea, Illinois, US  
Dennis L. Clapper, 115 Papillon Drive, Swansea, Illinois, US  
ROHO, INC., 100 Florida Avenue, Belleville, Illinois 62221, US
- (73) Omanik: ROHO, INC., 100 Florida Avenue, Belleville, Illinois 62221, US
- (74) Patendivolinik või ühine esindaja: Lembit Mitt

(54) Nimetus: **Istepadi**

(55) Reproduktsoon:

00762-01

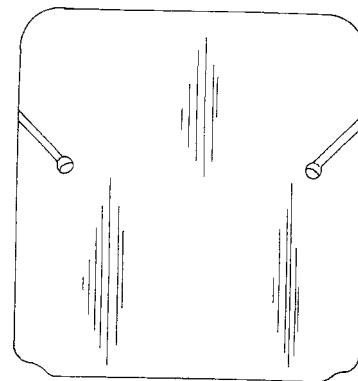
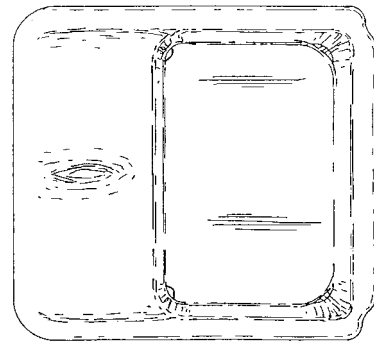
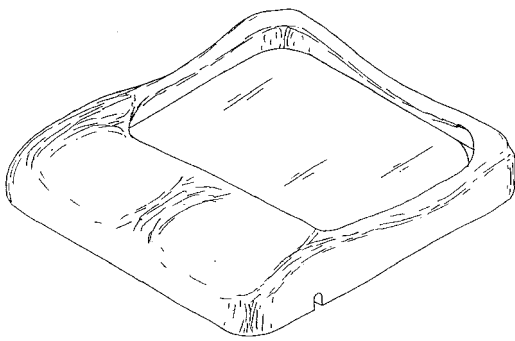



- (11) Registreeringu number: **00763**
- (15) Registreerimise kuupäev: 11.03.2003 (51) Klass: **20-03**
- (21) Taotluse number: D2003 00011
- (22) Esitamise kuupäev: 29.01.2003
- (24) Registreeringu kehtivuse  
alguse kuupäev: 29.01.2003
- (28) Variantide arv: 3
- (72) Autor: Ott Rätsep, Tornimäe 2, 10145 Tallinn EE
- (73) Omanik: UNICOM EESTI OÜ, Tornimäe 2, 10145 Tallinn EE
- (74) Patendivolinik või ühine esindaja: Ott Moorlat

(54) Nimetus: **Reklaamivahend**

(55) Reproduktsoon:

00763-01

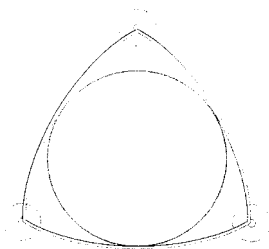
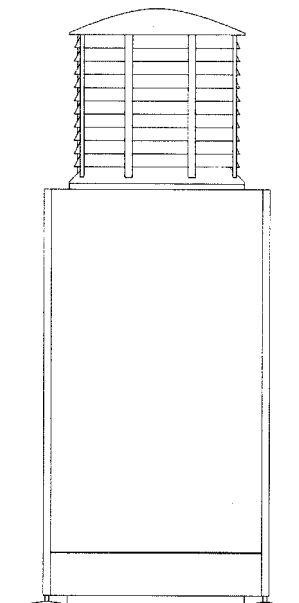
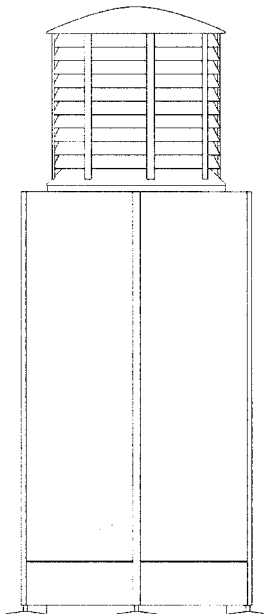

00763-02



00763-03



(11) Registreeringu number: **00764**

(15) Registreerimise kuupäev: 11.03.2003 (51) Klass: **06-09**

(21) Taotluse number: D2003 00012

(22) Esitamise kuupäev: 30.01.2003

(24) Registreeringu kehtivuse  
alguse kuupäev: 30.01.2003

(28) Variantide arv: 1

(72) Autor: *Autori andmeid ei avalikustata*

(73) Omanik: Vaike Elmik, Kolde pst 76-12, 10321 Tallinn, EE

(54) Nimetus: **Tissipadi**

(55) Reproduktsoon:

00764-01



(11) Registreeringu number: **00765**

(15) Registreerimise kuupäev: 11.03.2003

(21) Taotluse number: D2003 00014

(22) Esitamise kuupäev: 10.02.2003

(24) Registreeringu kehtivuse  
alguse kuupäev: 10.02.2003

(28) Variantide arv: 2

(72) Autor: Franklin D. McMahon, Tornimäe 2, 10145 Tallinn, EE

(73) Omanik: UNICOM EESTI OÜ, Tornimäe 2, 10145 Tallinn, EE

(74) Patendivolinik või ühine esindaja: Ott Moorlat

(51) Klass: **25-03**

(54) Nimetus: **Välistend kaardiga**

(55) Reproduktsoon:

00765-01



00765-02



- (11) Registreeringu number: **00766**
- (15) Registreerimise kuupäev: 11.03.2003 (51) Klass: **09-01**
- (21) Taotluse number: D2003 00015
- (22) Esitamise kuupäev: 12.02.2003
- (24) Registreeringu kehtivuse  
alguse kuupäev: 12.02.2003
- (28) Variantide arv: 2
- (72) Autor: Martti Martin, Kolde pst 102-70, 10316 Tallinn, EE
- (73) Omanik: Greiner Packaging Estonia AS, Rajakeskus 10, 76901 Tabasalu, EE
- (74) Patendivolinik või ühine esindaja: Lembit Mitt

(54) Nimetus: **Mahuti**

(55) Reproduktsoon:

00766-01



00766-02



- (11) Registreeringu number: **00767**
- (15) Registreerimise kuupäev: 11.03.2003 (51) Klass: **09-01**
- (21) Taotluse number: D2003 00016
- (22) Esitamise kuupäev: 12.02.2003
- (24) Registreeringu kehtivuse alguse kuupäev: 12.02.2003
- (28) Variantide arv: 1
- (72) Autor: Martti Martin, Kolde pst 102-70, 10316 Tallinn, EE
- (73) Omanik: Greiner Packaging Estonia AS, Rajakeskus 10, 76901 Tabasalu, EE
- (74) Patendivolinik või ühine esindaja: Lembit Mitt

(54) Nimetus: **Mahuti**

(55) Reproduktsoon:

00767-01

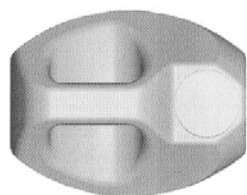
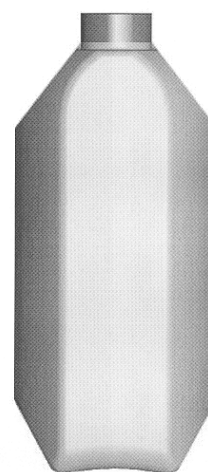
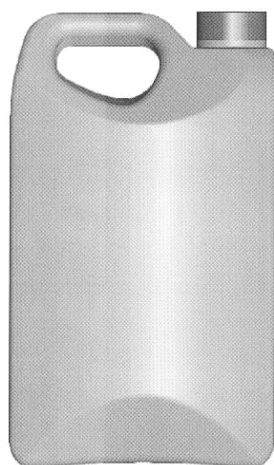
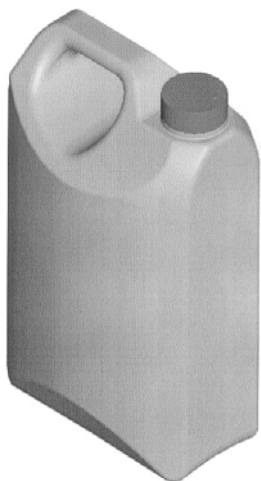

- (11) Registreeringu number: **00768**
- (15) Registreerimise kuupäev: 26.03.2003 (51) Klass: **23-02**
- (21) Taotluse number: D2002 00140
- (22) Esitamise kuupäev: 23.12.2002
- (24) Registreeringu kehtivuse alguse kuupäev: 23.12.2002
- (28) Variantide arv: 1
- (30) Prioriteediandmed: M20020409, 28.06.2002, FI
- (72) Autor: Janne Jaakkola, Leppäkatu 3 B 9, 33100 Tampere, FI  
Tapani Holma, Toljulantie 15, 36200 Kangasala, FI
- (73) Omanik: Metsä Tissue Oyj, Revontulentie 8 C, FIN-02100 Espoo, FI
- (74) Patendivolinik või ühine esindaja: Jüri Käosaar
- (54) Nimetus: **Tualettpaberihoidja 2 rullile**
- (55) Reproduktsoon:

00768-01



- (11) Registreeringu number: **00769**
- (15) Registreerimise kuupäev: 26.03.2003 (51) Klass: **23-02**
- (21) Taotluse number: D2002 00141
- (22) Esitamise kuupäev: 23.12.2002
- (24) Registreeringu kehtivuse alguse kuupäev: 23.12.2002
- (28) Variantide arv: 1
- (30) Prioriteediandmed: M20020409, 28.06.2002, FI
- (72) Autor: Janne Jaakkola, Leppäkatu 3 B 9, 33100 Tampere, FI  
Tapani Holma, Toljolanatie 15, 36200 Kangasala, FI  
Metsä Tissue Oyj, Revontulentie 8 C, FIN-02100 Espoo, FI
- (73) Omanik: Metsä Tissue Oyj, Revontulentie 8 C, FIN-02100 Espoo, FI
- (74) Patendivolinik või ühine esindaja: Kaie Puur

(54) Nimetus: **Tualettpaberihoidja 3 rullile**

(55) Reproduktsoon:

00769-01

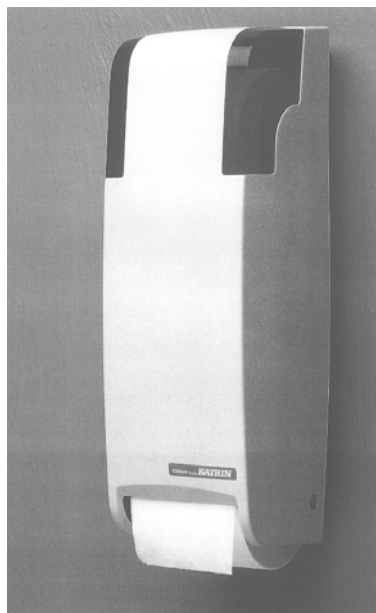
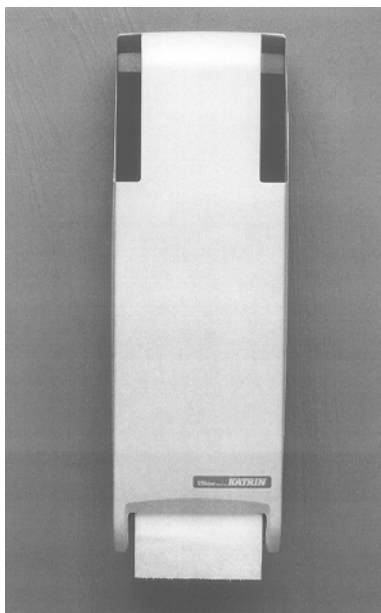



- (11) Registreeringu number: **00770**
- (15) Registreerimise kuupäev: 26.03.2003 (51) Klass: **23-02**
- (21) Taotluse number: D2002 00142
- (22) Esitamise kuupäev: 23.12.2002
- (24) Registreeringu kehtivuse alguse kuupäev: 23.12.2002
- (28) Variantide arv: 1
- (30) Prioriteediandmed: M20020409, 28.06.2002, FI
- (72) Autor: Janne Jaakkola, Leppäkatu 3 B 9, 33100 Tampere, FI  
Tapani Holma, Toljolaantie 15, 36200 Kangasala, FI  
Metsä Tissue Oyj, Revontulentie 8 C, FIN-02100 Espoo, FI
- (73) Omanik: Metsä Tissue Oyj, Revontulentie 8 C, FIN-02100 Espoo, FI
- (74) Patendivolinik või ühine esindaja: Jüri Käosaar

(54) Nimetus: **Paberkäterätihoidja**

(55) Reproduktsoon:

00770-01

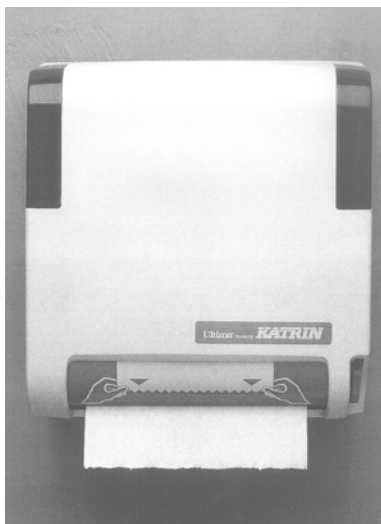

- (11) Registreeringu number: **00771**
- (15) Registreerimise kuupäev: 26.03.2003 (51) Klass: **23-02**
- (21) Taotluse number: D2002 00143
- (22) Esitamise kuupäev: 23.12.2002
- (24) Registreeringu kehtivuse alguse kuupäev: 23.12.2002
- (28) Variantide arv: 1
- (30) Prioriteediandmed: M20020409, 28.06.2002, FI
- (72) Autor: Janne Jaakkola, Leppäkatu 3 B 9, 33100 Tampere, FI  
Tapani Holma, Toljolaantie 15, 36200 Kangasala, FI  
Metsä Tissue Oyj, Revontulentie 8 C, FIN-02100 Espoo, FI
- (73) Omanik: Jüri Käosaar
- (74) Patendivolinik või ühine esindaja: Jüri Käosaar
- (54) Nimetus: **Vedelseebi dosaator**
- (55) Reproduktsoon:

00771-01

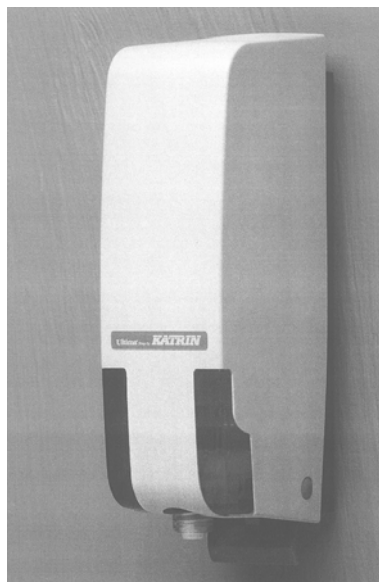
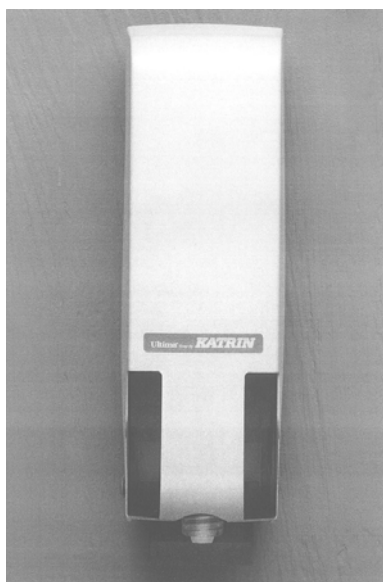

- (11) Registreeringu number: **00772**
- (15) Registreerimise kuupäev: 26.03.2003 (51) Klass: **23-04**
- (21) Taotluse number: D2002 00144
- (22) Esitamise kuupäev: 23.12.2002
- (24) Registreeringu kehtivuse  
alguse kuupäev: 23.12.2002
- (28) Variantide arv: 1
- (30) Prioriteediandmed: M20020409, 28.06.2002, FI
- (72) Autor: Janne Jaakkola, Leppäkatu 3 B 9, 33100 Tampere, FI  
Tapani Holma, Toljolanatie 15, 36200 Kangasala, FI  
Metsä Tissue Oyj, Revontulentie 8 C, FIN-02100 Espoo, FI
- (73) Omanik: Metsä Tissue Oyj, Revontulentie 8 C, FIN-02100 Espoo, FI
- (74) Patendivolinik või ühine esindaja: Jüri Käosaar
- (54) Nimetus: **Õhuvärskendaja**
- (55) Reproduktsoon:

00772-01



(11) Registreeringu number: **00773**

(15) Registreerimise kuupäev: 26.03.2003

(51) Klass: **25-02**

(21) Taotluse number: D2003 00009

(22) Esitamise kuupäev: 27.01.2003

(24) Registreeringu kehtivuse  
alguse kuupäev: 27.01.2003

(28) Variantide arv: 1

(72) Autor: Murayenko Oleksandr, Vormsi 4/33, 13913 Tallinn, EE

(73) Omanik: Murayenko Oleksandr, Vormsi 4/33, 13913 Tallinn, EE

(54) Nimetus: **Uks, komplekt "Dekoor"**

(55) Reproduktsoon:

00773-01

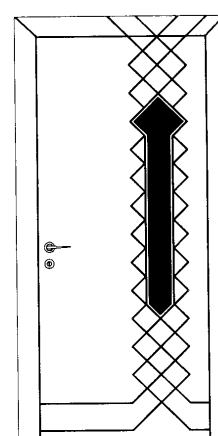
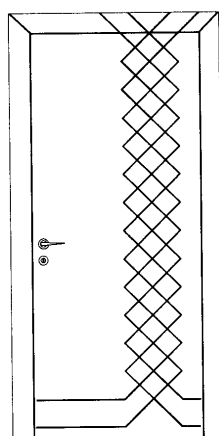
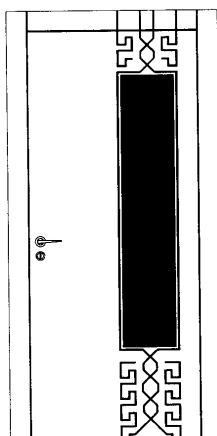
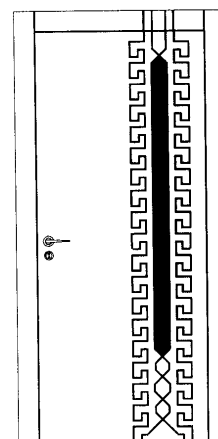
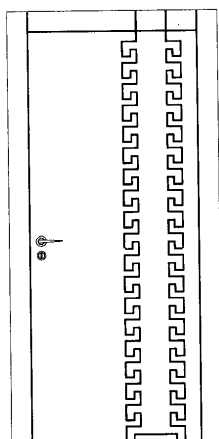
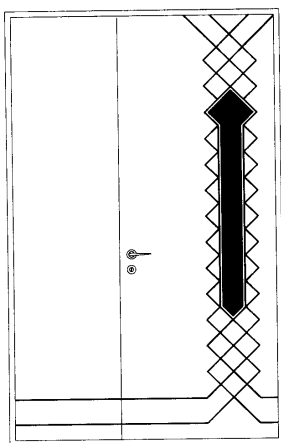

- (11) Registreeringu number: **00774**
- (15) Registreerimise kuupäev: 26.03.2003 (51) Klass: **25-02**
- (21) Taotluse number: D2003 00010
- (22) Esitamise kuupäev: 27.01.2003
- (24) Registreeringu kehtivuse alguse kuupäev: 27.01.2003
- (28) Variantide arv: 1
- (72) Autor: Murayenko Oleksandr, Vormsi 4/33, 13913 Tallinn, EE
- (73) Omanik: Murayenko Oleksandr, Vormsi 4/33, 13913 Tallinn, EE
- (54) Nimetus: **Uks, komplekt "Flora"**
- (55) Reproduksioon:

00774-01

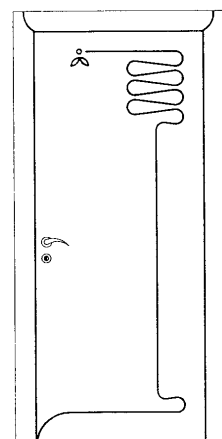
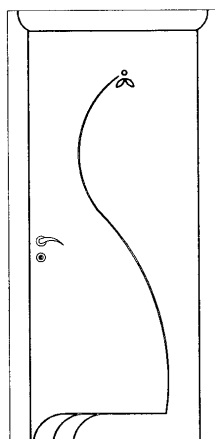
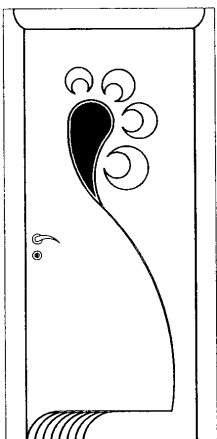
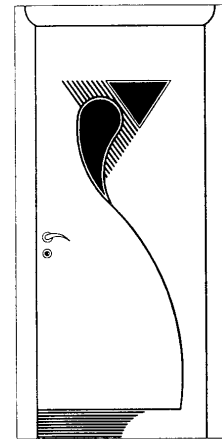
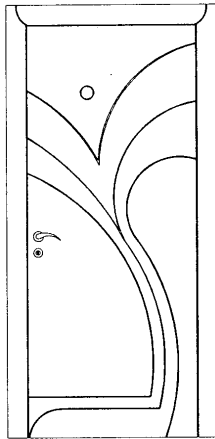
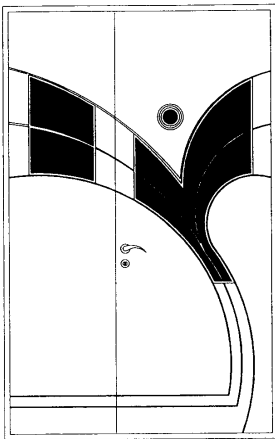

- (11) Registreeringu number: **00775**
- (15) Registreerimise kuupäev: 26.03.2003 (51) Klass: **09-01; 09-04**
- (21) Taotluse number: D2003 00013
- (22) Esitamise kuupäev: 31.01.2003
- (24) Registreeringu kehtivuse alguse kuupäev: 31.01.2003
- (28) Variantide arv: 2
- (30) Prioriteediandmed: 402 06 533.6, 31.07.2002, DE
- (72) Autor: Wilfried Huber, Kapellenberg 3, D-86938 Schondorf, DE
- (73) Omanik: KARWENDEL-WERKE HUBER GmbH & CO. KG, Karwendel Strasse 6-16, D-86807 Buchloe, DE
- (74) Patendivolinik või ühine esindaja: Lembit Mitt

(54) Nimetus: **Piimatoodete, kohupiimajuustu, jogurti, kohupiima tops**

(55) Reproduktsoon:

00775-01

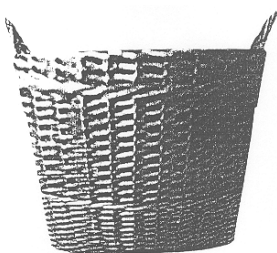

00775-02

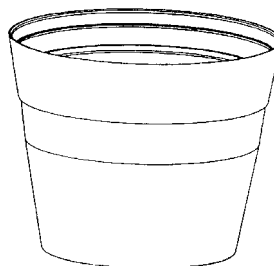
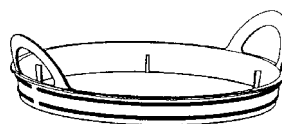

(11) Registreeringu number: **00776**

(15) Registreerimise kuupäev: 26.03.2003 (51) Klass: **20-03**

(21) Taotluse number: D2003 00017

(22) Esitamise kuupäev: 17.02.2003

(24) Registreeringu kehtivuse alguse kuupäev: 17.02.2003

(28) Variantide arv: 8

(72) Autor: Jaanus Miitel, Tornimäe 2, 10145 Tallinn, EE (variandid 1-6)  
Inga Gujyte, Tornimäe 2, 10145 Tallinn, EE (7. variant)  
Andris Tomsons, Tornimäe 2, 10145 Tallinn, EE (8. variant)

(73) Omanik: UNICOM EESTI OÜ, Tornimäe 2, 10145 Tallinn, EE

(74) Patendivolinik või ühine esindaja: Ott Moorlat

(54) Nimetus: **Linnasammas**

(55) Reproduktsoon:

00776-01

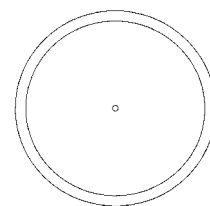
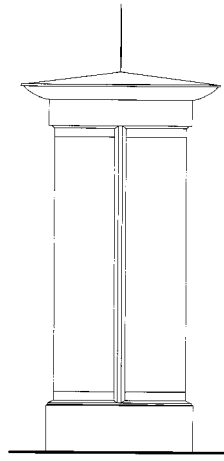
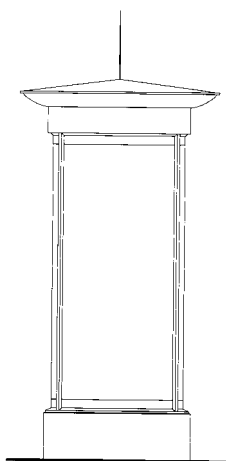
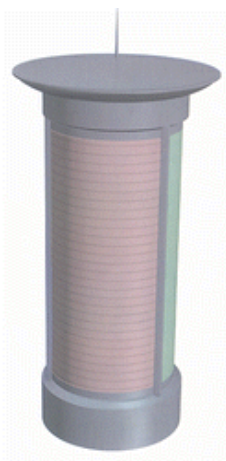

00776-02

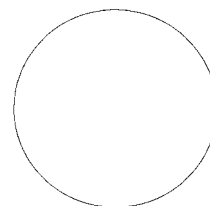
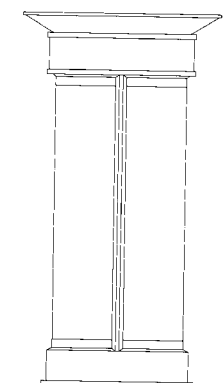
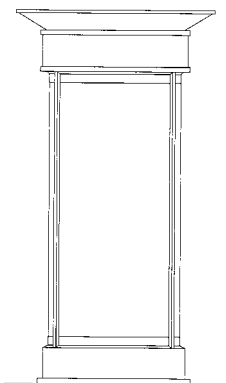

00776-03

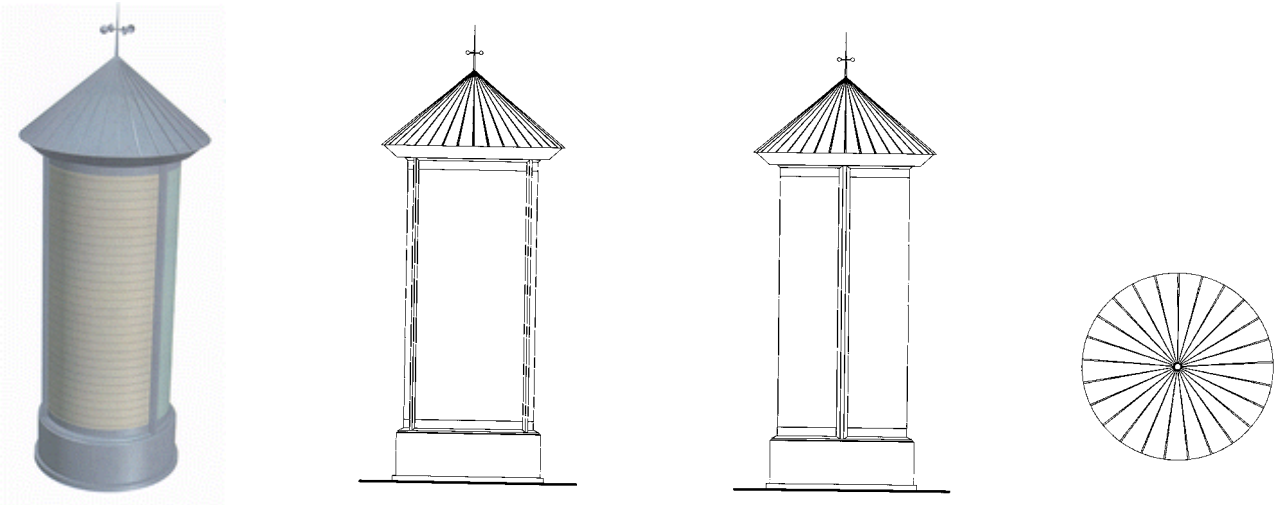

00776-04

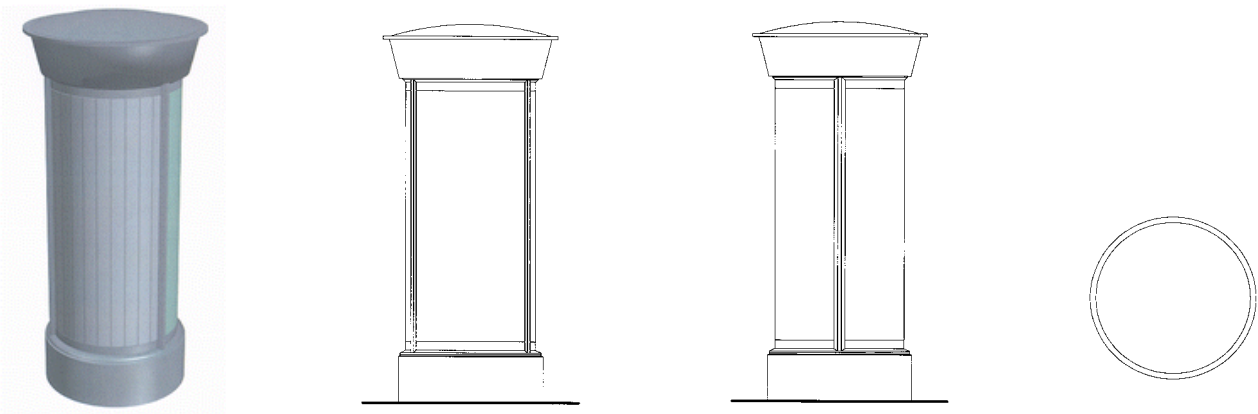

00776-05

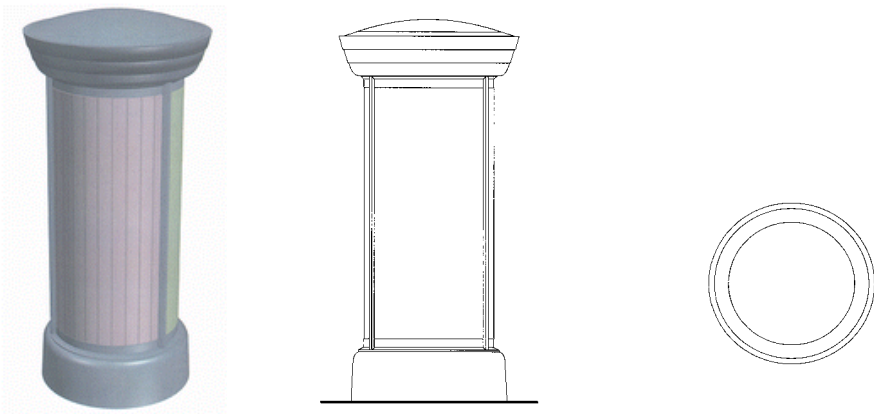



00776-06

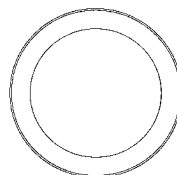
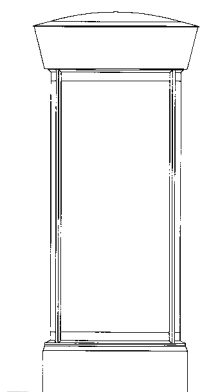
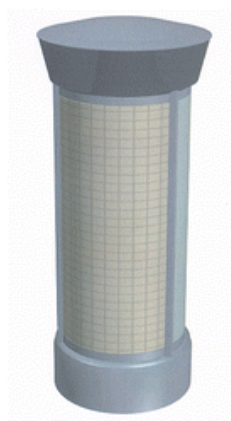

00776-07

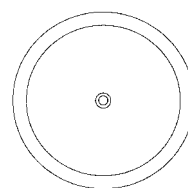
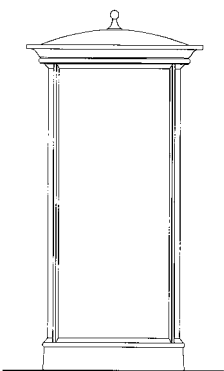
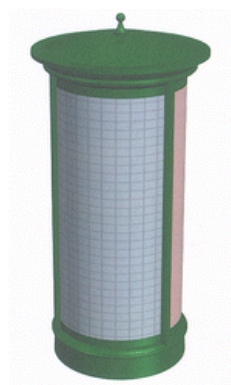

00776-08

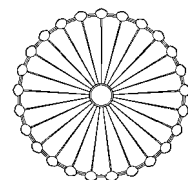
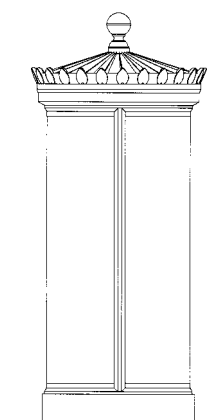
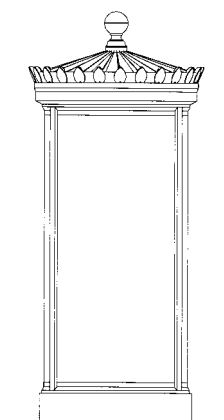
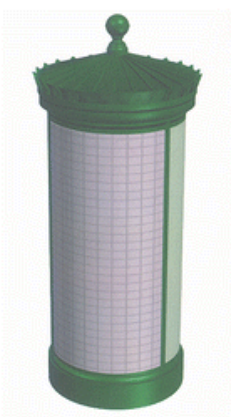

(11) Registreeringu number: **00777**

(15) Registreerimise kuupäev: 26.03.2003

(21) Taotluse number: D2003 00018

(22) Esitamise kuupäev: 17.02.2003

(24) Registreeringu kehtivuse  
alguse kuupäev: 17.02.2003

(28) Variantide arv: 1

(72) Autor: Valentinas Vizgirda, Tornimäe 2, 10145 Tallinn, EE

(73) Omanik: UNICOM EESTI OÜ, Tornimäe 2, 10145 Tallinn, EE

(74) Patendivolinik või ühine esindaja: Ott Moorlat

(51) Klass: **20-03**

(54) Nimetus: **Valgustatud katusega linnasammas**

(55) Reproduktsoon:

00777-01

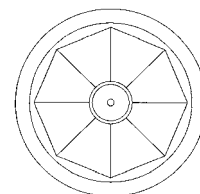
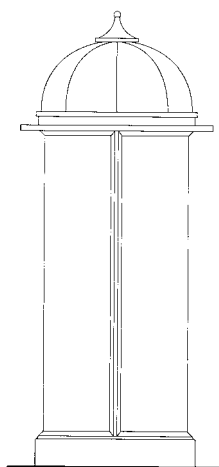
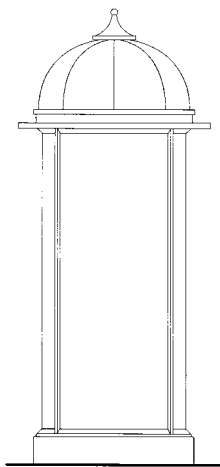
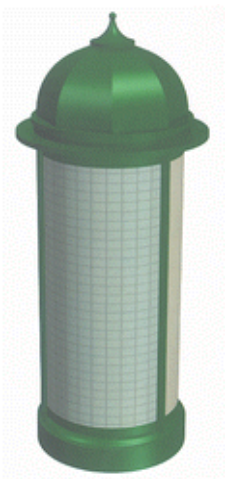

- (11) Registreeringu number: **00778**
- (15) Registreerimise kuupäev: 02.04.2003 (51) Klass: **24-01**
- (21) Taotluse number: D2003 00006
- (22) Esitamise kuupäev: 14.01.2003
- (24) Registreeringu kehtivuse alguse kuupäev: 14.01.2003
- (28) Variantide arv: 1
- (30) Prioriteediandmed: 29/163,996, 15.07.2002, US
- (72) Autor: Steven J. Daffer, 6604 Sally Lane, Edina, Minnesota 55439, US  
James M. Garrison, 3400 Quebec Avenue South, St. Louis Park, Minnesota 55426, US
- (73) Omanik: Visibelle Derma Institute, Inc., 9220 James Avenue South, Bloomington, Minnesota 55431, US
- (74) Patendivolinik või ühine esindaja: Kaie Puur
- (54) Nimetus: **Ravikabiin**
- (55) Reproduktsoon:

00778-01

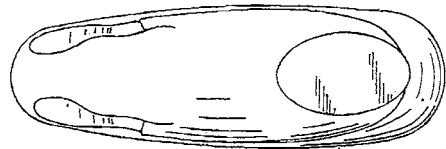
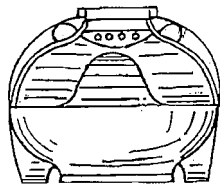
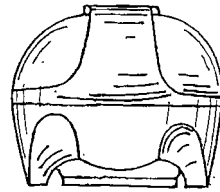
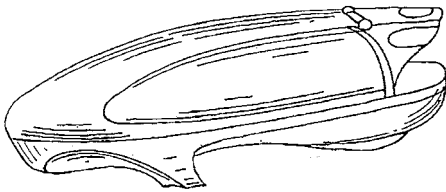

- (11) Registreeringu number: **00779**
- (15) Registreerimise kuupäev: 02.04.2003 (51) Klass: **13-02**
- (21) Taotluse number: D2003 00019
- (22) Esitamise kuupäev: 25.02.2003
- (24) Registreeringu kehtivuse alguse kuupäev: 25.02.2003
- (28) Variantide arv: 1
- (30) Prioriteediandmed: M20020508, 26.08.2002, FI
- (72) Autor: Anu Suomalainen, Rahintie 28, 21500 Piikkiö, FI  
Heli Säde, Liitoskatu 11, 24260 Salo, FI
- (73) Omanik: Nokia Corporation, Keilalahdentie 4, FIN-02150 Espoo, FI
- (74) Patendivolinik või ühine esindaja: Kaie Puur

(54) Nimetus: **Laadija**

(55) Reproduksioon:

00779-01

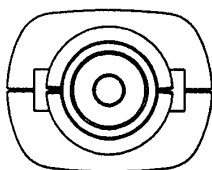
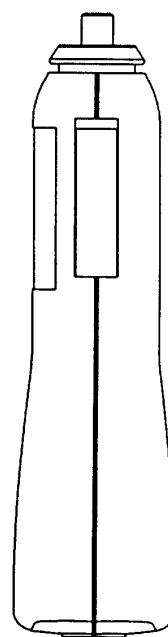
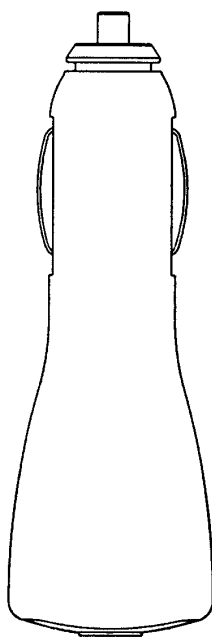
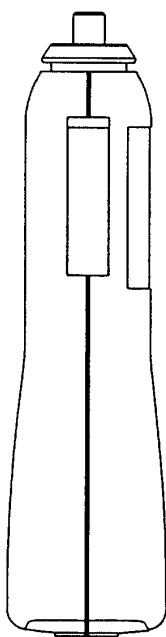
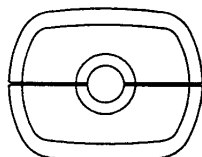

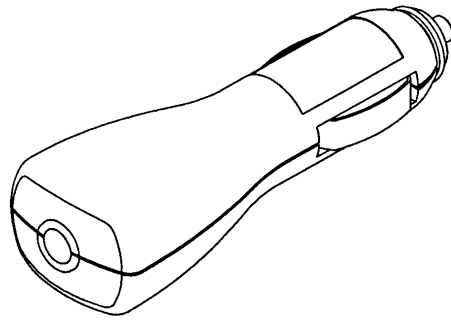
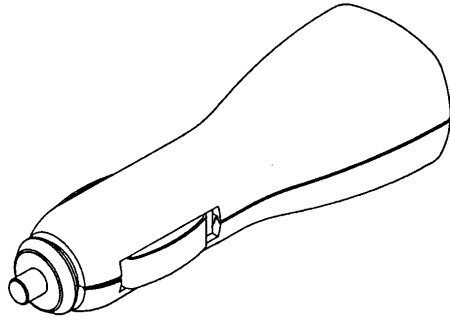
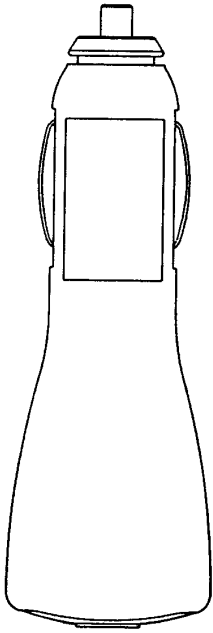

- (11) Registreeringu number: **00780**
- (15) Registreerimise kuupäev: 02.04.2003
- (21) Taotluse number: D2003 00022
- (22) Esitamise kuupäev: 27.02.2003
- (24) Registreeringu kehtivuse alguse kuupäev: 27.02.2003
- (28) Variantide arv: 1
- (72) Autor: Jaanus Ots, Roheline 38 b, Pärnu, EE  
Ranno Künnap, Kuldse Kodu 1-102, Pärnu, EE  
Mainos Grupp OÜ, Niidu 3, 80040 Pärnu, EE
- (73) Omanik:
- (54) Nimetus: **Reklaamidega kalender-märkmik**
- (55) Reproduktsoon:

00780-01



- (11) Registreeringu number: **00781**
- (15) Registreerimise kuupäev: 02.04.2003 (51) Klass: **20-03**
- (21) Taotluse number: D2003 00025
- (22) Esitamise kuupäev: 03.03.2003
- (24) Registreeringu kehtivuse  
alguse kuupäev: 03.03.2003
- (28) Variantide arv: 1
- (72) Autor: Sylvain M. Larray, BP 11, ZI Ste Apolline, 78373 Plaisir cedex, FR
- (73) Omanik: JCDecaux SA, 17 rue Soyer, 92200 Neuilly-sur-Seine, FR
- (74) Patendivolinik või ühine esindaja: Jaak Ostrat

(54) Nimetus: **Teeviit**

(55) Reproduktsoon:

00781-01

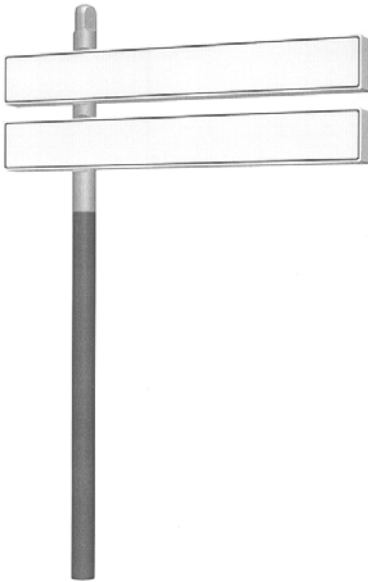

- (11) Registreeringu number: **00782**
- (15) Registreerimise kuupäev: 02.04.2003 (51) Klass: **14-03**
- (21) Taotluse number: D2003 00032
- (22) Esitamise kuupäev: 06.03.2003
- (24) Registreeringu kehtivuse alguse kuupäev: 06.03.2003
- (28) Variantide arv: 1
- (30) Prioriteediandmed: M20020538, 06.09.2002, FI
- (72) Autor: Panu Johansson, Bernhard Bangs Alle 20, 1sal tv, 2000 Frederiksberg, DK
- (73) Omanik: Nokia Corporation, Keilalahdentie 4, FIN-02150 Espoo, FI
- (74) Patendivolinik või ühine esindaja: Aivo Arula

(54) Nimetus: **Käsitelefoni klaviatuur**

(55) Reproduktsoon:

00782-01

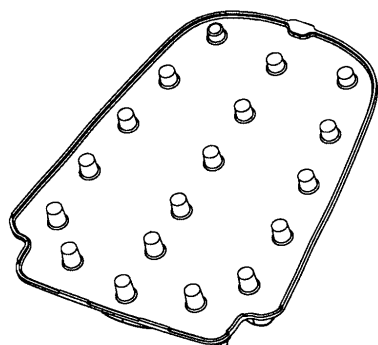
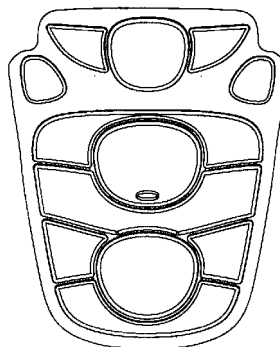
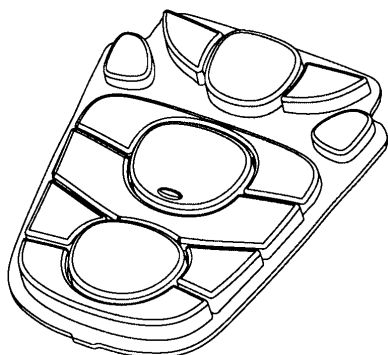



- (11) Registreeringu number: **00783**
- (15) Registreerimise kuupäev: 02.04.2003 (51) Klass: **14-03**
- (21) Taotluse number: D2003 00033
- (22) Esitamise kuupäev: 06.03.2003
- (24) Registreeringu kehtivuse  
alguse kuupäev: 06.03.2003
- (28) Variantide arv: 1
- (30) Prioriteediandmed: M20020538, 06.09.2002, FI
- (72) Autor: Panu Johansson, Bernhard Bangs Alle 20, 1sal tv, 2000 Frederiksberg, DK
- (73) Omanik: Nokia Corporation, Keilalahdentie 4, FIN-02150 Espoo, FI
- (74) Patendivolinik või ühine esindaja: Aivo Arula

(54) Nimetus: **Käsitelefoni tagapaneel**

(55) Reproduktsioon:

00783-01

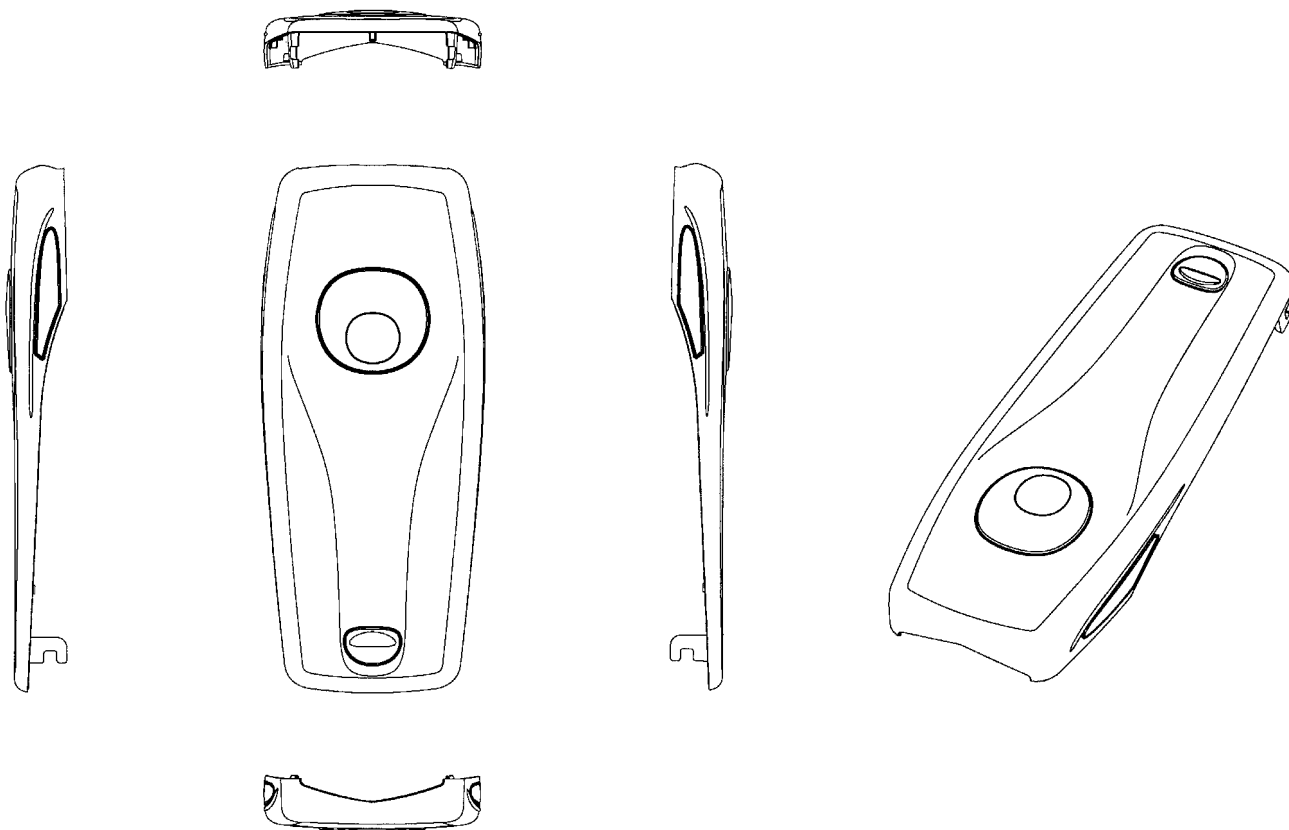

- (11) Registreeringu number: **00784**
- (15) Registreerimise kuupäev: 02.04.2003 (51) Klass: **14-03**
- (21) Taotluse number: D2003 00034
- (22) Esitamise kuupäev: 06.03.2003
- (24) Registreeringu kehtivuse alguse kuupäev: 06.03.2003
- (28) Variantide arv: 1
- (30) Prioriteediandmed: M20020538, 06.09.2002, FI
- (72) Autor: Panu Johansson, Bernhard Bangs Alle 20, 1sal tv, 2000 Frederiksberg, DK
- (73) Omanik: Nokia Corporation, Keilalahdentie 4, FIN-02150 Espoo, FI
- (74) Patendivolinik või ühine esindaja: Aivo Arula

(54) Nimetus: **Käsitelefoni esipaneel**

(55) Reproduktsioon:

00784-01

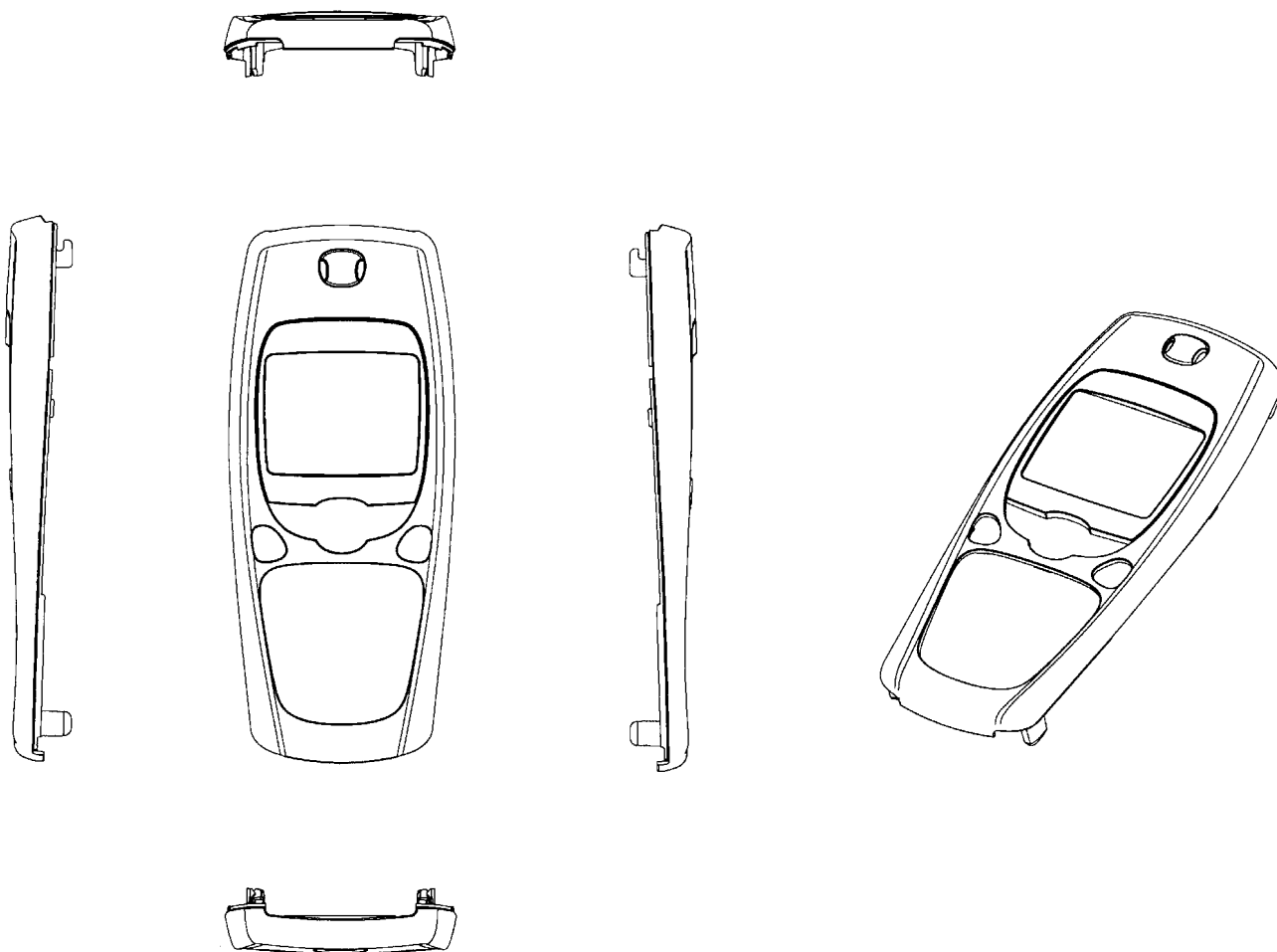

- (11) Registreeringu number: **00785**
- (15) Registreerimise kuupäev: 02.04.2003 (51) Klass: 14-03
- (21) Taotluse number: D2003 00035
- (22) Esitamise kuupäev: 06.03.2003
- (24) Registreeringu kehtivuse alguse kuupäev: 06.03.2003
- (28) Variantide arv: 1
- (30) Prioriteediandmed: M20020538, 06.09.2002, FI
- (72) Autor: Panu Johansson, Bernhard Bangs Alle 20, 1sal tv, 2000 Frederiksberg, DK
- (73) Omanik: Nokia Corporation, Keilalahdentie 4, FIN-02150 Espoo, FI
- (74) Patendivolinik või ühine esindaja: Aivo Arula

(54) Nimetus: **Käsitelefon**

(55) Reproduktsioon:

00785-01

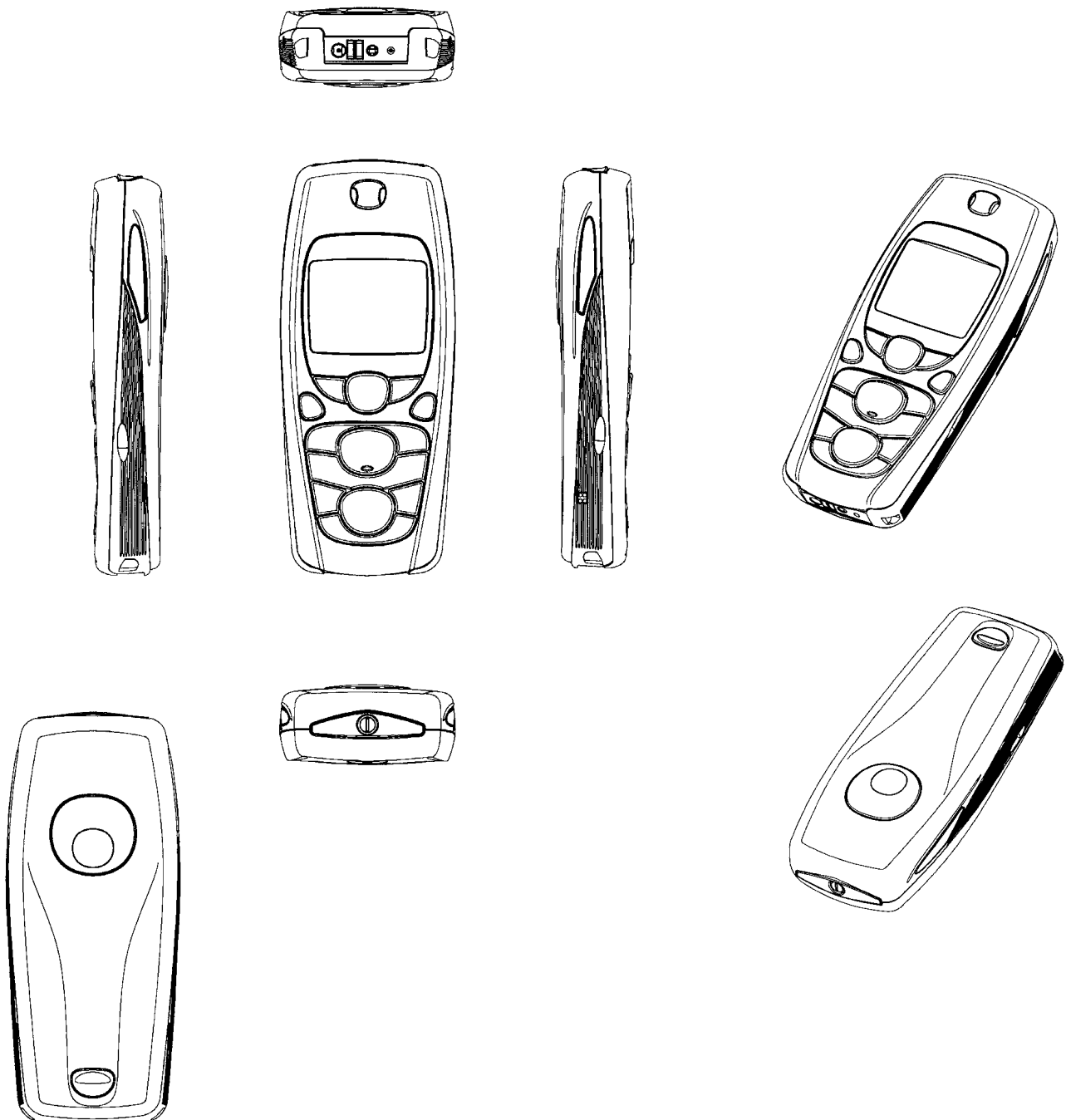

- (11) Registreeringu number: **00786**
- (15) Registreerimise kuupäev: 04.04.2003 (51) Klass: **05-06**
- (21) Taotluse number: D2003 00040
- (22) Esitamise kuupäev: 10.03.2003
- (24) Registreeringu kehtivuse  
alguse kuupäev: 10.03.2003
- (28) Variantide arv: 1
- (30) Prioriteediandmed: 20020773, 13.12.2002, NO
- (72) Autor: Miisa Suviskaari, Design Bridge, 18 Clarkenwell Close, London EC1R 0QN, GB
- (73) Omanik: Metsä Tissue Oyj, Revontulentie 8 C, FIN-02100 Espoo, FI
- (74) Patendivolinik või ühine esindaja: Kaie Puur

(54) Nimetus: **Absorbeeriva paberi muster**

(55) Reproduktsoon:

00786-01

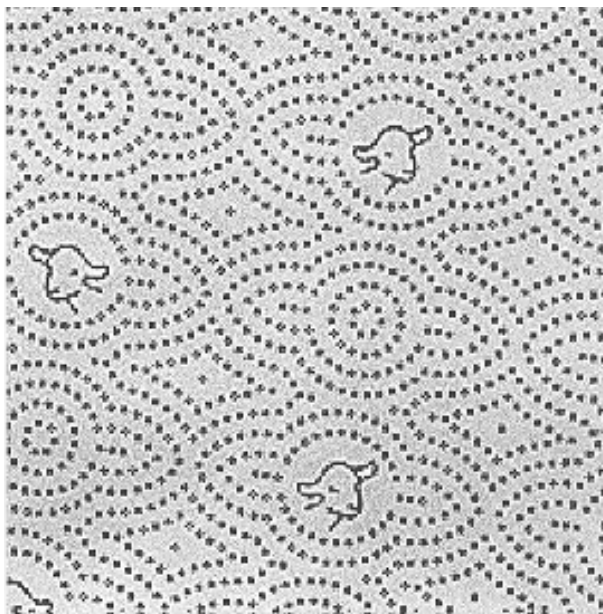

(11) Registreeringu number: **00787**

(15) Registreerimise kuupäev: 04.04.2003

(51) Klass: 14-03

(21) Taotluse number: D2003 00041

(22) Esitamise kuupäev: 13.03.2003

(24) Registreeringu kehtivuse  
alguse kuupäev: 13.03.2003

(28) Variantide arv: 1

(30) Prioriteediandmed: M20020557, 13.09.2002, FI

(72) Autor: Pekka Majanen, Verkaranta 5 D 43, 20660 Littoinen, FI

(73) Omanik: Nokia Corporation, Keilalahdentie 4, FIN-02150 Espoo, FI

(74) Patendivolinik või ühine esindaja: Aivo Arula

(54) Nimetus: **Käsitelefon**

(55) Reproduktsoon:

00787-01

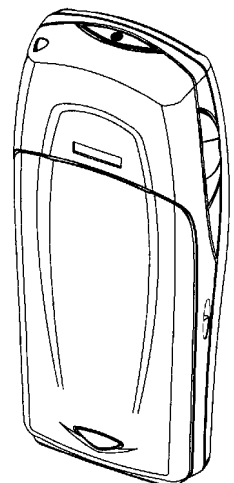
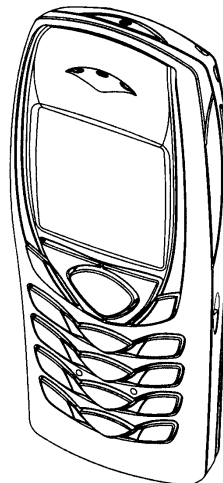
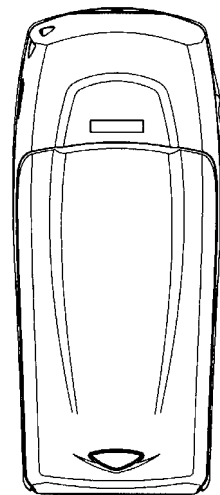
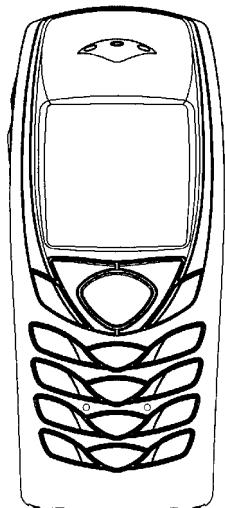
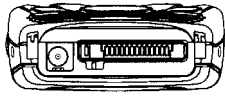

(11) Registreeringu number: **00788**

(15) Registreerimise kuupäev: 04.04.2003

(51) Klass: **14-03**

(21) Taotluse number: D2003 00042

(22) Esitamise kuupäev: 13.03.2003

(24) Registreeringu kehtivuse  
alguse kuupäev: 13.03.2003

(28) Variantide arv: 1

(30) Prioriteediandmed: M20020557, 13.09.2002, FI

(72) Autor: Pekka Majanen, Verkaranta 5 D 43, 20660 Littoinen, FI

(73) Omanik: Nokia Corporation, Keilalahdentie 4, FIN-02150 Espoo, FI

(74) Patendivolinik või ühine esindaja: Aivo Arula

(54) Nimetus: **Käsitelefoni esipaneel**

(55) Reproduksioon:

00788-01

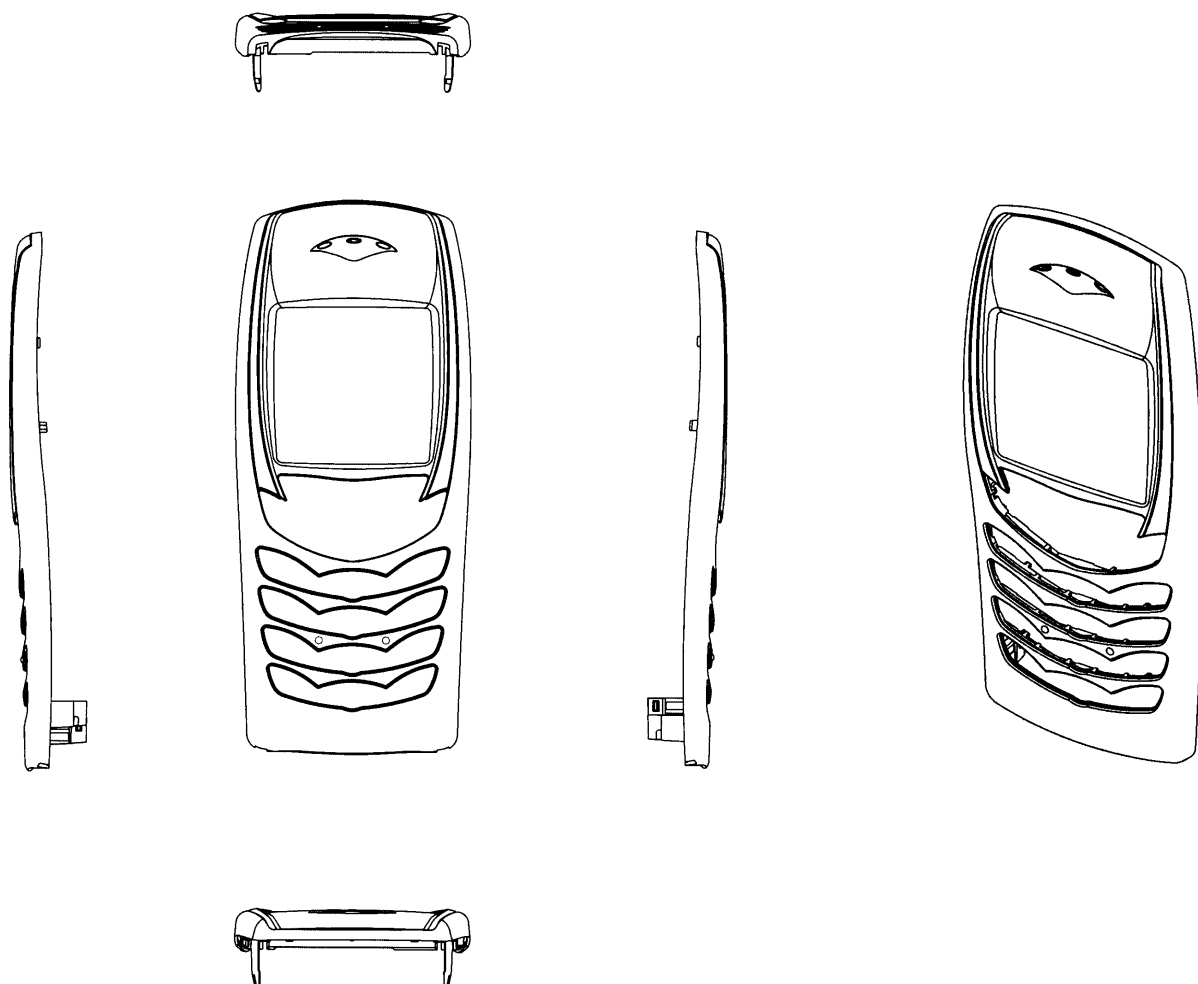

- (11) Registreeringu number: **00789**
- (15) Registreerimise kuupäev: 04.04.2003 (51) Klass: **14-03**
- (21) Taotluse number: D2003 00043
- (22) Esitamise kuupäev: 13.03.2003
- (24) Registreeringu kehtivuse  
alguse kuupäev: 13.03.2003
- (28) Variantide arv: 1
- (30) Prioriteediandmed: M20020557, 13.09.2002, FI
- (72) Autor: Pekka Majanen, Verkaranta 5 D 43, 20660 Littoinen, FI
- (73) Omanik: Nokia Corporation, Keilalahdentie 4, FIN-02150 Espoo, FI
- (74) Patendivolinik või ühine esindaja: Aivo Arula

(54) Nimetus: **Käsitelefoni klaviatuur**

(55) Reproduktsoon:

00789-01

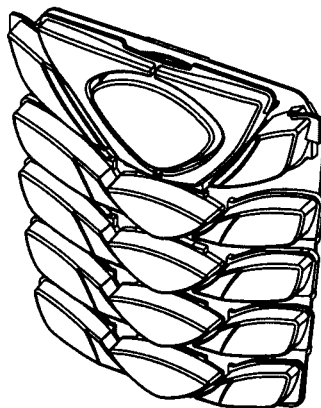
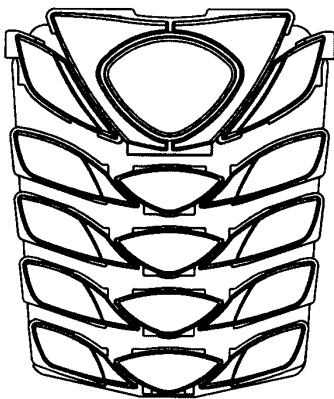

(11) Registreeringu number: **00790**

(15) Registreerimise kuupäev: 04.04.2003

(51) Klass: **14-03**

(21) Taotluse number: D2003 00044

(22) Esitamise kuupäev: 13.03.2003

(24) Registreeringu kehtivuse  
alguse kuupäev: 13.03.2003

(28) Variantide arv: 1

(30) Prioriteediandmed: M20020557, 13.09.2002, FI

(72) Autor: Pekka Majanen, Verkaranta 5 D 43, 20660 Littoinen, FI

(73) Omanik: Nokia Corporation, Keilalahdentie 4, FIN-02150 Espoo, FI

(74) Patendivolinik või ühine esindaja: Aivo Arula

(54) Nimetus: **Käsitelefoni tagapaneel**

(55) Reproduksioon:

00790-01

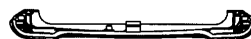
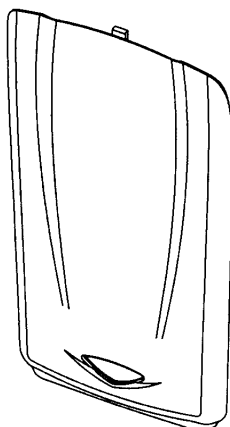
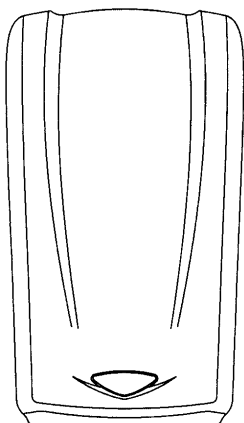



- (11) Registreeringu number: **00791**
- (15) Registreerimise kuupäev: 14.04.2003 (51) Klass: **04-01**
- (21) Taotluse number: D2002 00121
- (22) Esitamise kuupäev: 29.11.2002
- (24) Registreeringu kehtivuse alguse kuupäev: 29.11.2002
- (28) Variantide arv: 1
- (30) Prioriteediandmed: 29/161,450, 31.05.2002, US
- (72) Autor: Ashok H. Solanky, 9105 Rouzie Court, Mechanicsville, Virginia 23116, US  
Robert E. Lee, 11802 Prince Regent Place, Richmond, Virginia 23233, US  
Charles L. Dendy, 232 Tranquility Drive, Ruther Glen, Virginia 22546, US  
Philip Morris Products Inc., 3601 Commerce Road, Richmond, Virginia 23234, US
- (73) Omanik: Philip Morris Products Inc., 3601 Commerce Road, Richmond, Virginia 23234, US
- (74) Patendivolinik või ühine esindaja: Toom Pungas
- (54) Nimetus: **Haripuhastusseade**
- (55) Reproduktsoon:

00791-01

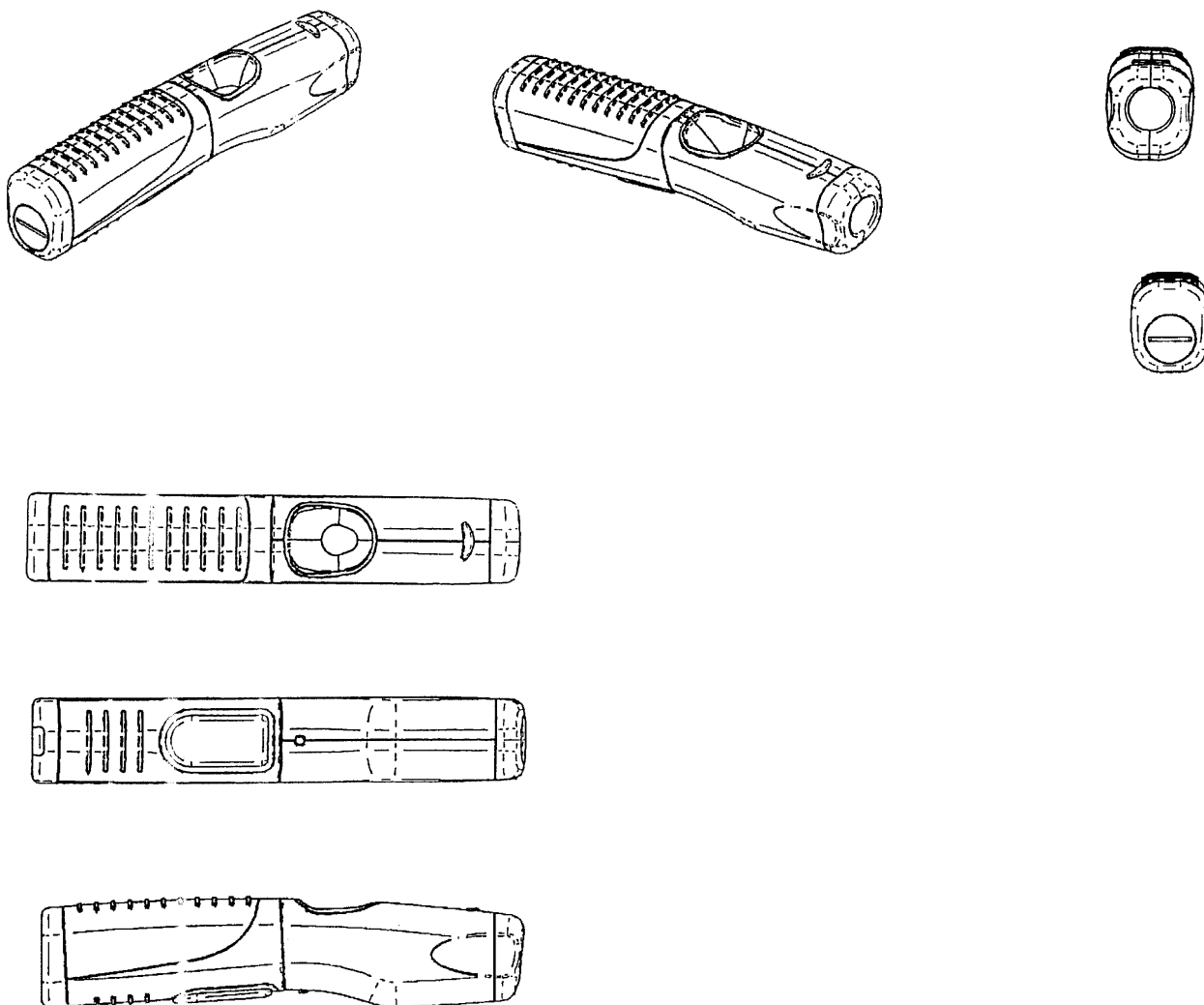

- (11) Registreeringu number: **00792**
- (15) Registreerimise kuupäev: 14.04.2003 (51) Klass: **09-01**
- (21) Taotluse number: D2003 00021
- (22) Esitamise kuupäev: 26.02.2003
- (24) Registreeringu kehtivuse alguse kuupäev: 26.02.2003
- (28) Variantide arv: 1
- (30) Prioriteediandmed: 20030006, 07.01.2003, NO
- (72) Autor: Hedda H. Braathen, c/o Scandinavian Design Group AS, Postboks 4340 Nydalen, 0402 Oslo, NO
- (73) Omanik: Stabburet AS, Postboks 711, N-1411 Kolbotn, NO
- (74) Patendivolinik või ühine esindaja: Kaie Puur

(54) Nimetus: **Pudel**

(55) Reproduktsoon:

00792-01

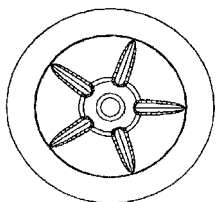
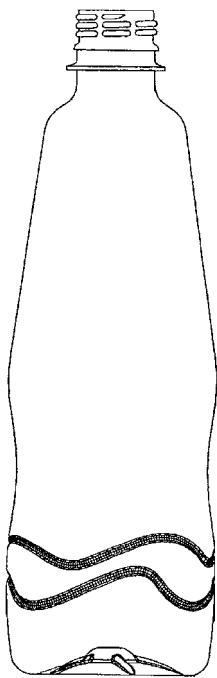

(11) Registreeringu number:

**00793**

(15) Registreerimise kuupäev:

14.04.2003

(51) Klass: **11-01**

(21) Taotluse number:

D2003 00024

(22) Esitamise kuupäev:

03.03.2003

(24) Registreeringu kehtivuse  
alguse kuupäev:

03.03.2003

(28) Variantide arv:

1

(72) Autor:

Kärt Summatavet, Haaviku tee 1A, 12113 Tallinn, EE

(73) Omanik:

Kärt Summatavet, Haaviku tee 1A, 12113 Tallinn, EE

(54) Nimetus:

**Ehtekomplekt**

(55) Reproduktsoon:

00793-01

**Registreeritud värvilisena**



- (11) Registreeringu number: **00794**
- (15) Registreerimise kuupäev: 14.04.2003 (51) Klass: **08-07**
- (21) Taotluse number: D2003 00026
- (22) Esitamise kuupäev: 04.03.2003
- (24) Registreeringu kehtivuse alguse kuupäev: 04.03.2003
- (28) Variantide arv: 1
- (30) Prioriteediandmed: M20020637, 28.10.2002, FI
- (72) Autor: Jarmo Saarinen, Pitkäahtentie 4 A 19, FIN-39880 Lempäälä, FI
- (73) Omanik: Abloy Oy, Wahlforssinkatu 20, FIN-80100 Joensuu, FI
- (74) Patendivolinik või ühine esindaja: Lembit Mitt

(54) Nimetus: **Ukselink**

(55) Reproduksioon:

00794-01

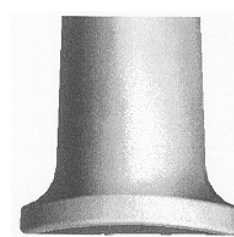
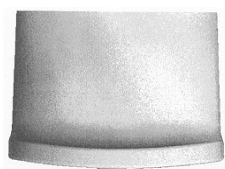
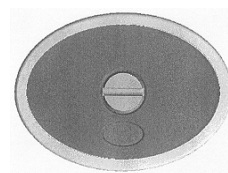
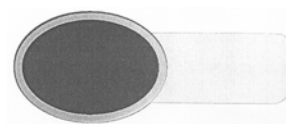
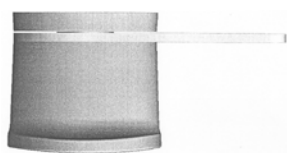
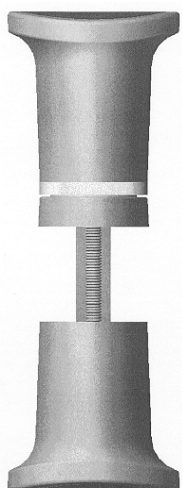
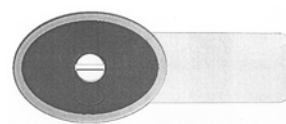
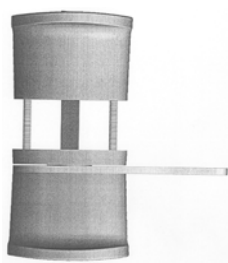
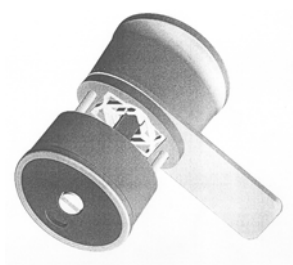

(11) Registreeringu number: **00795**

(15) Registreerimise kuupäev: 17.04.2003

(51) Klass: **20-03**

(21) Taotluse number: D2003 00046

(22) Esitamise kuupäev: 31.03.2003

(24) Registreeringu kehtivuse  
alguse kuupäev: 31.03.2003

(28) Variantide arv: 1

(72) Autor: Ott Rätsep, Tornimäe 2, 10145 Tallinn, EE

(73) Omanik: UNICOM EESTI OÜ, Tornimäe 2, 10145 Tallinn, EE

(74) Patendivolinik või ühine esindaja: Ott Moorlat

(54) Nimetus: **Linnasammas**

(55) Reproduktsoon:

00795-01

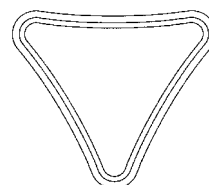
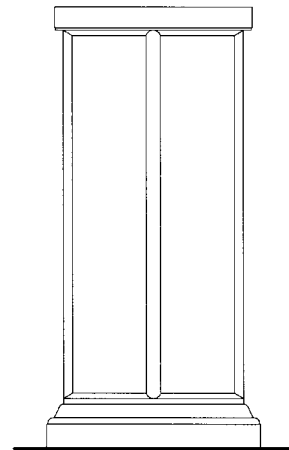
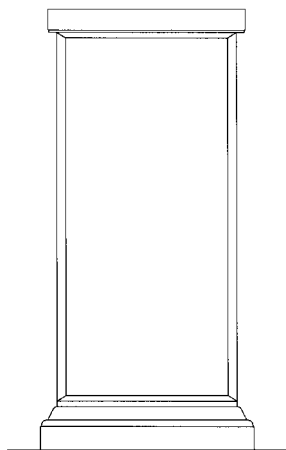

(11) Registreeringu number: **00796**

(15) Registreerimise kuupäev: 17.04.2003

(51) Klass: **06-03; 06-05**

(21) Taotluse number: D2003 00047

(22) Esitamise kuupäev: 31.03.2003

(24) Registreeringu kehtivuse  
alguse kuupäev: 31.03.2003

(28) Variantide arv: 3

(72) Autor: Ivari Männi, Lauteri 1-55, 10114 Tallinn, EE

(73) Omanik: OÜ Woodman Trade, Neeme, Jõelähtme vald, 74203 Harju maakond, EE

(74) Patendivolinik või ühine esindaja: Ott Moorlat

(54) Nimetus: **Komplekteeritav laud**

(55) Reproduktsoon:

00796-01

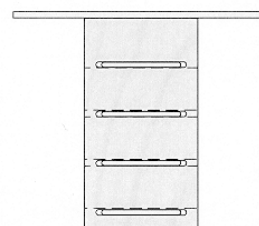
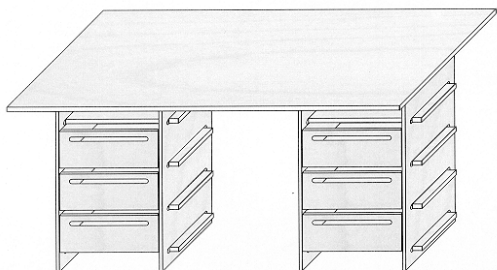

00796-02

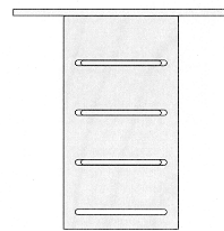
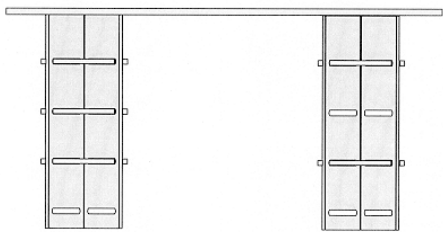
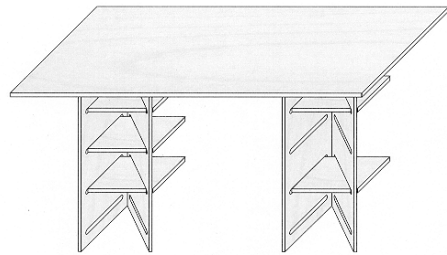

00796-03

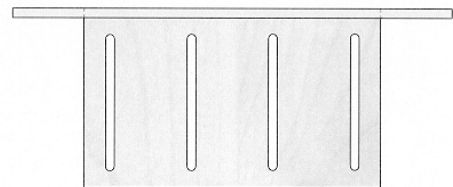
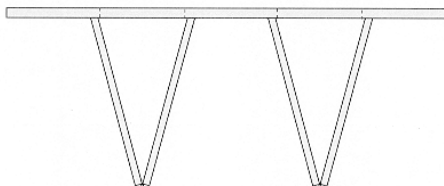
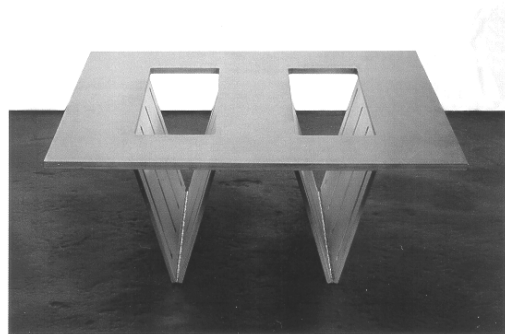
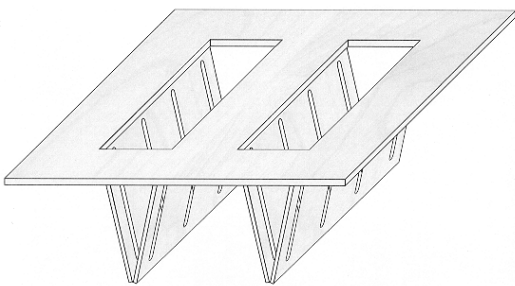

- (11) Registreeringu number: **00797**
- (15) Registreerimise kuupäev: 28.04.2003 (51) Klass: **14-03**
- (21) Taotluse number: D2003 00036
- (22) Esitamise kuupäev: 06.03.2003
- (24) Registreeringu kehtivuse alguse kuupäev: 06.03.2003
- (28) Variantide arv: 1
- (30) Prioriteediandmed: 29/166,906, 06.09.2002, US
- (72) Autor: Panu Johansson, Bernhard Bangs Alle 20, 1sal tv, 2000 Frederiksberg, DK  
Jamie Langford, 3404 Parr Road, Grapevine, Texas 76051,US  
Nokia Corporation, Keilalahdentie 4, FIN-02150 Espoo, FI
- (73) Omanik: Nokia Corporation, Keilalahdentie 4, FIN-02150 Espoo, FI
- (74) Patendivolinik või ühine esindaja: Jüri Käosaar
- (54) Nimetus: **Käsitelefon**
- (55) Reproduktsoon:

00797-01

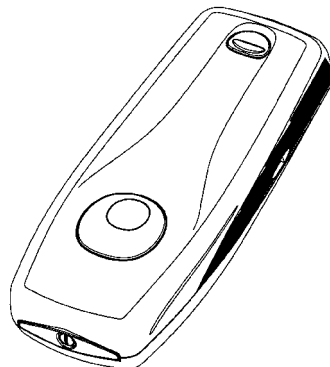
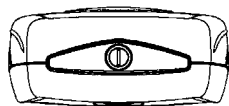
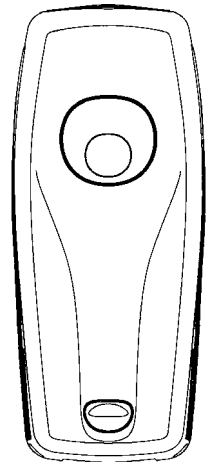
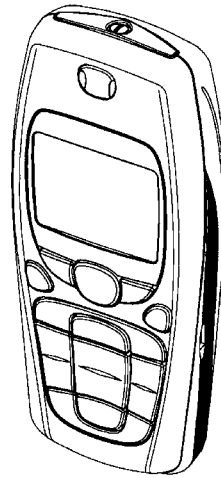
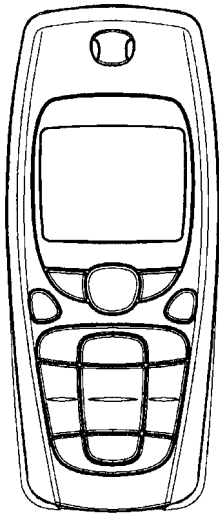



- (11) Registreeringu number: **00798**
- (15) Registreerimise kuupäev: 28.04.2003 (51) Klass: **14-03**
- (21) Taotluse number: D2003 00039
- (22) Esitamise kuupäev: 10.03.2003
- (24) Registreeringu kehtivuse  
alguse kuupäev: 10.03.2003
- (28) Variantide arv: 1
- (30) Prioriteediandmed: 29/167,004, 09.09.2002, US
- (72) Autor: Andrew Gartrell, 20520 Ventura Boulevard#103, Woodland Hills,  
California 91364, US  
Alastair Curtis, 4711 Larkwood Avenue, Woodland Hills, California 91364, US  
Andrea Finke-Anlauf, Friedensallee 12, D-38104 Braunschweig, DE  
Nokia Corporation, Keilalahdentie 4, FIN-02150 Espoo, FI
- (73) Omanik:
- (74) Patendivolinik või ühine esindaja: Kaie Puur

(54) Nimetus: **Käsitelefon**

(55) Reproduktsoon:

00798-01

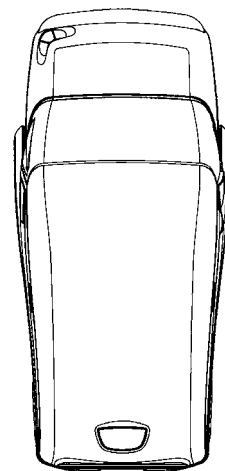
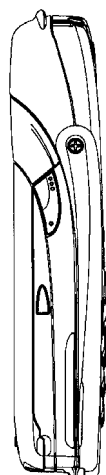
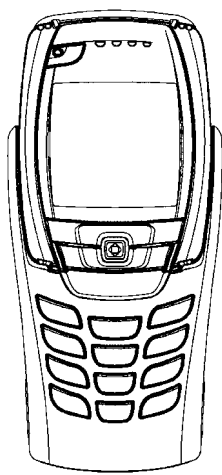
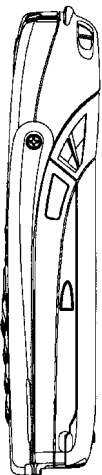
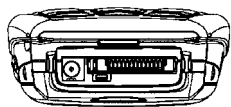

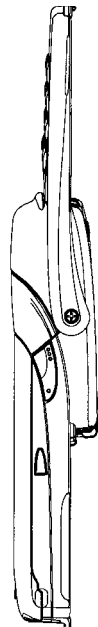
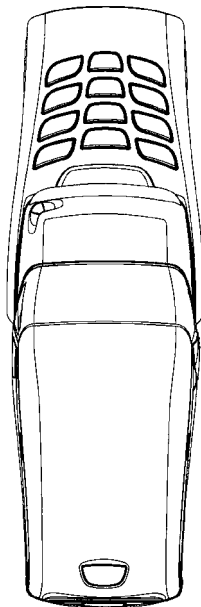
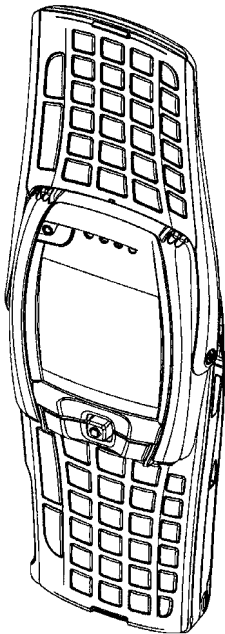
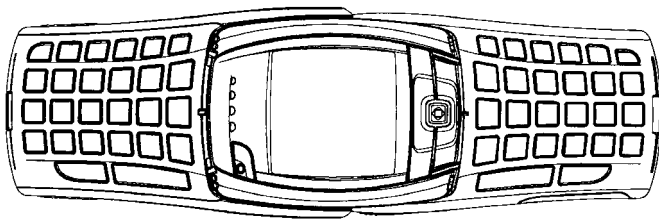
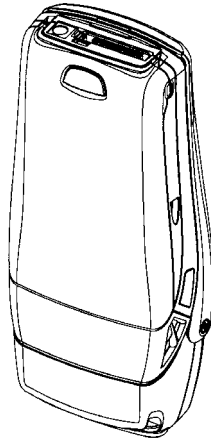
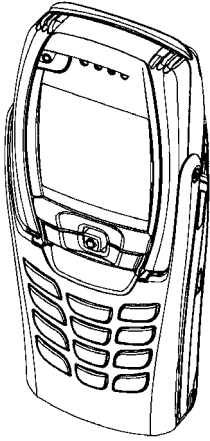

- (11) Registreeringu number: **00799**
- (15) Registreerimise kuupäev: 28.04.2003 (51) Klass: **09-07**
- (21) Taotluse number: D2003 00048
- (22) Esitamise kuupäev: 03.04.2003
- (24) Registreeringu kehtivuse  
alguse kuupäev: 03.04.2003
- (28) Variantide arv: 3
- (72) Autor: Ričardas Suslavičius, Veiverių g. 134 c, LT-3018 Kaunas, LT
- (73) Omanik: UAB SUSLAVIČIUS-FELIX, Veiverių g. 134 c, LT-3018 Kaunas, LT
- (74) Patendivolinik või ühine esindaja: Olga Treufeldt

(54) Nimetus: **Sulgur**

(55) Reproduktsioon:

00799-01

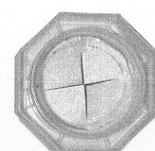
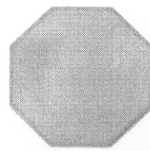
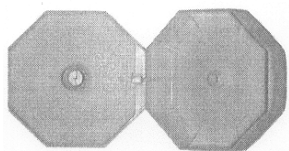
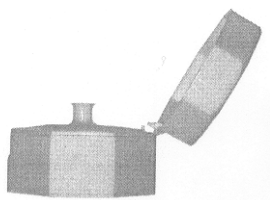

00799-02

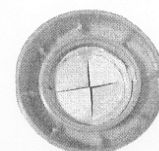
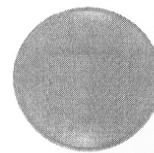
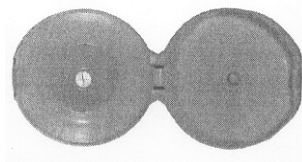
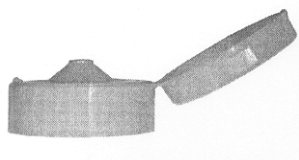

00799-03

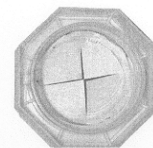
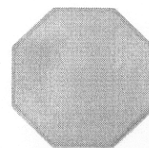
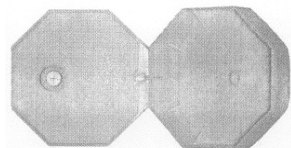
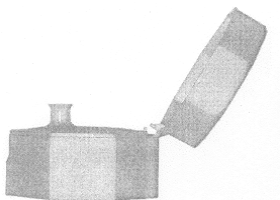

- (11) Registreeringu number: **00800**
- (15) Registreerimise kuupäev: 28.04.2003 (51) Klass: **09-03**
- (21) Taotluse number: D2003 00049
- (22) Esitamise kuupäev: 07.04.2003
- (24) Registreeringu kehtivuse alguse kuupäev: 07.04.2003
- (28) Variantide arv: 1
- (30) Prioriteediandmed: 40209105.1, 01.11.2002, DE
- (72) Autor: Willi Diete, am Falkenberg 19, 51381 Levekusen, DE
- (73) Omanik: Henkel Kommanditgesellschaft auf Aktien, Henkelstrasse 67, 40589 Düsseldorf, DE
- (74) Patendivolinik või ühine esindaja: Raivo Matsoo

- (54) Nimetus: **Kokkupandav karp**
- (55) Reproduksioon:

00800-01

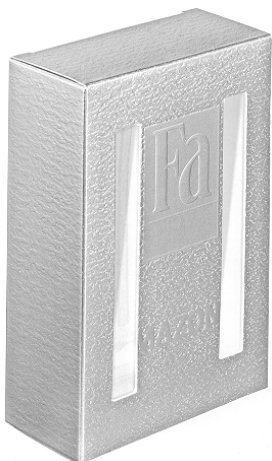

## II. TÖÖSTUSDISAINILAHENDUSE REGISTREERINGU KEHTIVUSE PIKENDAMINE

(11)	(18)
00226	10.03.2008
00227	11.03.2008
00228	09.04.2008
00230	09.04.2008
00232	22.04.2008
00233	22.04.2008
00234	23.04.2008
00235	24.04.2008
00236	24.04.2008
00237	24.04.2008
00238	24.04.2008
00239	24.04.2008
00240	24.04.2008
00241	24.04.2008
00242	28.04.2008
00243	28.04.2008
00247	06.05.2008
00248	06.05.2008
00249	08.05.2008
00251	25.05.2008
00252	25.05.2008
00262	30.04.2008
00315	26.05.2008
00316	26.05.2008
00317	26.05.2008
00318	26.05.2008

## III. TÖÖSTUSDISAINILAHENDUSE REGISTREERINGU ANDMETE MUUTMINE

Reg nr	Muudetud andmed	Registrikande jõustumise kuupäev
00262	(74) Sirje Kahu	17.03.2003

## VII. LOENDID

REGISTREERITUD TÖÖSTUSDISAINILAHENDUSTE  
SÜSTEMAATILINE LOEND

Rahvusvahelise klassifikatsiooni klass ja alaklass(id)	Registreerimis- taotluse number	Registreeringu number
--	------------------------------------	--------------------------

04-01	D2002 00121	00791	14-03	D2003 00032	00782
05-06	D2003 00040	00786	14-03	D2003 00033	00783
06-03; 06-05	D2003 00047	00796	14-03	D2003 00034	00784
06-04; 06-05	D2003 00001	00752	14-03	D2003 00035	00785
06-09	D2003 00007	00762	14-03	D2003 00036	00797
06-09	D2003 00012	00764	14-03	D2003 00039	00798
08-07	D2003 00026	00794	14-03	D2003 00041	00787
09-01	D2002 00146	00751	14-03	D2003 00042	00788
09-01	D2003 00015	00766	14-03	D2003 00043	00789
09-01	D2003 00016	00767	14-03	D2003 00044	00790
09-01; 09-04	D2003 00013	00775	19-02; 20-03	D2003 00008	00757
09-01	D2003 00021	00792	19-02; 19-03	D2003 00022	00780
09-03	D2003 00049	00800	20-03	D2003 00011	00763
09-03	D2002 00113	00749	20-03	D2003 00017	00776
09-07	D2003 00002	00753	20-03	D2003 00018	00777
09-07	D2003 00003	00754	20-03	D2003 00025	00781
09-07	D2003 00004	00755	20-03	D2003 00046	00795
09-07	D2003 00005	00756	23-02	D2002 00140	00768
09-07	D2003 00048	00799	23-02	D2002 00141	00769
10-02	D2002 00126	00758	23-02	D2002 00142	00770
10-02	D2002 00127	00759	23-02	D2002 00143	00771
10-02	D2002 00128	00760	23-04	D2002 00144	00772
10-02	D2002 00129	00761	24-01	D2003 00006	00778
11-01	D2003 00024	00793	25-02	D2003 00009	00773
13-02	D2002 00139	00750	25-02	D2003 00010	00774
13-02	D2003 00019	00779	25-03	D2003 00014	00765

**REGISTREERITUD TÖÖSTUSDISAINILAHENDUSTE REGISTREERIMISTAOTLUSTE  
NUMBRILINE LOEND**

Registreerimis- taotluse number	Registreeringu number	Rahvusvahelise klassifikatsiooni klass(id) ja alaklass(id)
------------------------------------	--------------------------	--

D2002 00113	00749	09-03	D2003 00014	00765	25-03
D2002 00121	00791	04-01	D2003 00015	00766	09-01
D2002 00126	00758	10-02	D2003 00016	00767	09-01
D2002 00127	00759	10-02	D2003 00017	00776	20-03
D2002 00128	00760	10-02	D2003 00018	00777	20-03
D2002 00129	00761	10-02	D2003 00019	00779	13-02
D2002 00139	00750	13-02	D2003 00021	00792	09-01
D2002 00140	00768	23-02	D2003 00022	00780	19-02; 19-03
D2002 00141	00769	23-02	D2003 00024	00793	11-01
D2002 00142	00770	23-02	D2003 00025	00781	20-03
D2002 00143	00771	23-02	D2003 00026	00794	08-07
D2002 00144	00772	23-04	D2003 00032	00782	14-03
D2002 00146	00751	09-01	D2003 00033	00783	14-03
D2003 00001	00752	06-04; 06-05	D2003 00034	00784	14-03
D2003 00002	00753	09-07	D2003 00035	00785	14-03
D2003 00003	00754	09-07	D2003 00036	00797	14-03
D2003 00004	00755	09-07	D2003 00039	00798	14-03
D2003 00005	00756	09-07	D2003 00040	00786	05-06
D2003 00006	00778	24-01	D2003 00041	00787	14-03
D2003 00007	00762	06-09	D2003 00042	00788	14-03
D2003 00008	00757	19-02; 20-03	D2003 00043	00789	14-03
D2003 00009	00773	25-02	D2003 00044	00790	14-03
D2003 00010	00774	25-02	D2003 00046	00795	20-03
D2003 00011	00763	20-03	D2003 00047	00796	06-03; 06-05
D2003 00012	00764	06-09	D2003 00048	00799	09-07
D2003 00013	00775	09-01; 09-04	D2003 00049	00800	09-03

## VIII. TÖÖSTUSDISAINIALASED ÕIGUSAKTID JA MUU INFO

RIIKLIKUS PATENDIVOLNIKE REGISTRIS REGISTREERITUD PATENDIVOLNIKE NIMEKIRI  
(seisuga 26. märts 2003)

Register on asutatud 1. septembril 2001. a Vabariigi Valitsuse 7. augusti 2001. a määrusega nr 271 "Riikliku patendivolinike registri asutamine ja registri pidamise põhimäärus" (RT I 2001, 70, 426) patendivoliniku seaduse § 21 alusel (RT I 2001, 27, 151).

## TEGEVUSVALDKOND: KAUBAMÄRK, TÖÖSTUSDISAINILAHENDUS JA GEOGRAAFILINE TÄHIS

<b>Arno ANIJALG</b>	<b>OÜ USTERVALL</b> Raekoja plats 16 51004 Tartu pk 21, 50002 Tartu telefon: (07) 441 980 telefaks: (07) 441 785 e-post: anijalg@ustervall.ee <a href="http://www.ustervall.ee">http://www.ustervall.ee</a> võõrkeeled: saksa, vene	<b>Uno JÄÄGER</b>	<b>Patendibüroo Käosaar &amp; Co OÜ</b> Rüütli 51A, 80010 Pärnu telefon: (044) 7 10 21 telefaks: (044) 7 10 01 GSM: 055 11 758 e-post: uno@estpak.ee <a href="http://www.kaosaar.ee">http://www.kaosaar.ee</a> võõrkeeled: inglise, soome, vene
<b>Aivo ARULA</b>	<b>Patendibüroo Käosaar &amp; Co OÜ</b> Tähe 94 50107 Tartu telefon: (07) 383 051 telefaks: (07) 383 055 e-post: info@kaosaar.ee <a href="http://www.kaosaar.ee">http://www.kaosaar.ee</a> võõrkeeled: inglise, vene	<b>Sirje KAHU</b>	<b>OÜ USTERVALL</b> Raekoja plats 16 51004 Tartu pk 21, 50002 Tartu telefon: (07) 441 980 telefaks: (07) 441 785 e-post: skahu@ustervall.ee <a href="http://www.ustervall.ee">http://www.ustervall.ee</a> võõrkeeled: inglise, vene
<b>Martina BÖCKLER</b>	<b>OÜ LASVET</b> Suurtüki 4a, 10133 Tallinn pk 3136, 10505 Tallinn telefon: 6 40 66 00 telefaks: 6 40 66 04 e-post: lasvet@lasvet.ee <a href="http://www.lasvet.ee">http://www.lasvet.ee</a> võõrkeeled: inglise, vene, soome	<b>Lembit KALEV</b>	<b>Patendibüroo ROOSILLA OÜ</b> Järveotsa tee 39-61 13520 Tallinn telefon: 657 1722; 657 5381 telefaks: 657 5381 GSM: 051 19 951 e-post: roosilla@roosilla.ee <a href="http://www.roosilla.ee">http://www.roosilla.ee</a> võõrkeeled: inglise, vene
<b>Alla HÄMMALOV</b>	<b>OÜ Intels</b> Riia 11-3 51010 Tartu telefon: (07) 42 04 01 telefaks: (07) 42 03 26 e-post: intels@estpak.ee võõrkeeled: inglise, poola, vene	<b>Urmas KAULER</b>	<b>Patendibüroo TURVAJA OÜ</b> Kaupmehe 8 10114 Tallinn telefon: 6 40 31 09 telefaks: 6 40 31 05 e-post: kauler@turvaja.ee <a href="http://www.turvaja.ee">http://www.turvaja.ee</a> võõrkeeled: inglise, vene, soome
<b>Juhan HÄMMALOV</b>	<b>OÜ Intels</b> Riia 11-3 51010 Tartu telefon: (07) 42 04 01 telefaks: (07) 42 03 26 e-post: intels@estpak.ee võõrkeeled: inglise, saksa, vene	<b>Urmas KERNU</b>	<b>AAA Patendibüroo OÜ</b> Tartu mnt 16 10117 Tallinn pk 3926, 10509 Tallinn telefon: 660 5910, 660 5911 telefaks: 660 5912 e-post: aaa@aaa.ee <a href="http://www.aaa.ee">http://www.aaa.ee</a> võõrkeeled: inglise, saksa, soome, vene



- Ljubov KESSELMAN** **OÜ Kesna**  
 Tedre 77-52  
 10616 Tallinn  
 telefon: 6 608 068  
 telefaks: 6 608 069  
 e-post: kesna@online.ee  
 võõrkeeled: inglise, vene
- Marina KESSELMAN** **OÜ Kesna**  
 Tedre 77-52  
 10616 Tallinn  
 telefon: 6 608 068  
 telefaks: 6 608 069  
 e-post: kesna@online.ee  
 võõrkeeled: inglise, saksa, vene
- Heinu KOITEL** **Patendi- & Kaubamärgibüroo Koitel OÜ**  
 Tartu mnt 65  
 10115 Tallinn  
 pk 1759, 10902 Tallinn  
 telefon: 6 033 260  
 telefaks: 6 033 261  
 e-post: koitel@koitel.ee  
<http://www.koitel.ee>  
 võõrkeeled: inglise, soome, vene
- Raivo KOITEL** **Patendi- & Kaubamärgibüroo Koitel OÜ**  
 Tartu mnt 65  
 10115 Tallinn  
 pk 1759, 10902 Tallinn  
 telefon: 6 033 260  
 telefaks: 6 033 261  
 e-post: koitel@koitel.ee  
<http://www.koitel.ee>  
 võõrkeeled: inglise, soome, vene
- Mart-Enn KOPPEL** kontaktandmed:  
 OÜ Advokaadibüroo Andrus Lillo  
 Rüütli 14, 51007 Tartu  
 telefon: (07) 303 470;  
 (07) 303 472  
 telefaks: (07) 303 471  
 e-post: martenn.koppel@mail.ee  
 e-post: mail@advokaadid.ee  
[http://www.advokaadid.ee/index\\_ee.htm](http://www.advokaadid.ee/index_ee.htm)  
 võõrkeeled: inglise, vene, soome
- Heinrich KRUPP** **Patendibüroo TURVAJA OÜ**  
 Kaupmehe 8  
 10114 Tallinn  
 telefon: 6 40 31 09  
 telefaks: 6 40 31 05  
 e-post: turvaja@turvaja.ee  
<http://www.turvaja.ee>  
 võõrkeeled: saksa, vene
- Jüri KÄOSAAR** **Patendibüroo Käosaar & Co OÜ**  
 Tähe 94  
 50107 Tartu  
 telefon: (07) 383 051  
 telefaks: (07) 383 055  
 e-post: info@kaosaar.ee  
<http://www.kaosaar.ee>  
 võõrkeeled: inglise, vene
- Reet MAASIKAMÄE** **OÜ Kaitsepurus**  
 Mulla 4-3  
 10611 Tallinn  
 telefon: 6 739 097 &  
 6 332 798  
 telefaks: 6 774 844  
 e-post: purus@online.ee &  
 purus@hot.ee  
<http://www.hot.ee/purus/>  
 võõrkeeled: inglise, vene
- Raivo MATSOO** **RM Hirvela Patendibüroo OÜ**  
 Saku 15, 11314 Tallinn  
 telefon: 6 140 816  
 telefaks: 6 140 818  
 e-post: hirvela@online.ee  
 võõrkeeled: inglise, vene
- Elle MELLIK** **AAA Patendibüroo OÜ**  
 Tartu mnt 16  
 10117 Tallinn  
 pk 3926, 10509 Tallinn  
 telefon: 660 5910, 660 5911  
 telefaks: 660 5912  
 e-post: aaa@aaa.ee  
<http://www.aaa.ee>  
 võõrkeeled: inglise, vene
- Lembit MITT** **AAA Patendibüroo OÜ**  
 Tartu mnt 16  
 10117 Tallinn  
 pk 3926, 10509 Tallinn  
 telefon: 660 5910, 660 5911  
 telefaks: 660 5912  
 e-post: aaa@aaa.ee  
<http://www.aaa.ee>  
 võõrkeeled: inglise, vene
- Ott MOORLAT** **OÜ Moorlat & Ko Patendibüroo**  
 pk 723, 12902 Tallinn  
 telefon: 655 0450 & 654 2844  
 telefaks: 654 2844  
 e-post: ott.moorlat@moorlat.ee  
<http://www.moorlat.ee>  
 võõrkeeled: inglise, vene

- Anfia MORNA**      **Patendibüroo TURVAJA OÜ**  
 Kaupmehe 8, 10114 Tallinn  
 telefon: 6 40 31 09  
 telefaks: 6 40 31 05  
 e-post: morna@turvaja.ee  
 http://www.turvaja.ee  
 võõrkeeled: inglise, vene
- Tõnu NELAS**      **AAA Patendibüroo OÜ**  
 Tartu mnt 16  
 10117 Tallinn  
 pk 3926, 10509 Tallinn  
 telefon: 660 5910, 660 5911  
 telefaks: 660 5912  
 e-post: aaa@aaa.ee  
 http://www.aaa.ee  
 võõrkeeled: inglise, vene, soome
- Jüri OLT**      **Patendibüroo Käosaar & Co OÜ**  
 Tähe 94, 50107 Tartu  
 telefon: (07) 383 051  
 telefaks: (07) 383 055  
 e-post: info@kaosaar.ee  
 http://www.kaosaar.ee  
 võõrkeeled: inglise, saksa, soome, vene
- Jaak OSTRAT**      **OÜ LASVET**  
 Suurtüki 4a, 10133 Tallinn  
 pk 3136, 10505 Tallinn  
 telefon: 6 40 66 00  
 telefaks: 6 40 66 04  
 e-post: lasvet@lasvet.ee  
 http://www.lasvet.ee  
 võõrkeeled: inglise, saksa, soome, vene
- Villu PAVELTS**      **OÜ LASVET**  
 Suurtüki 4a, 10133 Tallinn  
 pk 3136, 10505 Tallinn  
 telefon: 6 40 66 00  
 telefaks: 6 40 66 04  
 e-post: lasvet@lasvet.ee  
 http://www.lasvet.ee  
 võõrkeeled: inglise, soome, vene
- Anneli PUNGAS**      **OÜ Synest**  
 pk 977, 13402 Tallinn  
 telefon: 6 609 786  
 telefaks: 6 609 787  
 e-post: anneli@synest.ee  
 võõrkeeled: inglise, saksa, vene, prantsuse, soome, rootsi
- Toom PUNGAS**      **OÜ Synest**  
 pk 977, 13402 Tallinn  
 telefon: 6 609 786  
 telefaks: 6 609 787  
 e-post: toom@synest.ee  
 võõrkeeled: inglise, saksa, soome, vene
- Kaie PUUR**      **Patendibüroo Käosaar & Co OÜ**  
 Tähe 94  
 50107 Tartu  
 telefon: (07) 383 051  
 telefaks: (07) 383 055  
 e-post: info@kaosaar.ee  
 http://www.kaosaar.ee  
 võõrkeeled: inglise, vene
- Tarmo ROSMAN**      **Rosman ja Partnerid OÜ**  
 pk 652, 12602 Tallinn  
 telefon: 656 14 50  
 telefaks: 656 14 50  
 e-post: tarman@cc.ttu.ee  
 võõrkeeled: saksa, inglise, ungari, vene
- Arvo SALUMÄE**      **OÜ Amende Patendibüroo**  
 Raua 65  
 10152 Tallinn  
 telefon: 6 486 125  
 telefaks: 6 410 174  
 e-post: amende@hot.ee  
 võõrkeeled: inglise, saksa, soome, vene
- Harald TEHVER**      **Patendibüroo TURVAJA OÜ**  
 Kaupmehe 8  
 10114 Tallinn  
 telefon: 6 40 31 09  
 telefaks: 6 40 31 05  
 e-post: tehver@turvaja.ee  
 http://www.turvaja.ee  
 võõrkeeled: inglise, saksa, vene
- Olga TREUFELDT**      **Patendibüroo TURVAJA OÜ**  
 Kaupmehe 8  
 10114 Tallinn  
 telefon: 6 40 31 09  
 telefaks: 6 40 31 05  
 e-post: olga@turvaja.ee  
 http://www.turvaja.ee  
 võõrkeeled: inglise, vene
- Enn URGAS**      **Patendibüroo TURVAJA OÜ**  
 Kaupmehe 8  
 10114 Tallinn  
 telefon: 6 40 31 09  
 telefaks: 6 40 31 05  
 e-post: urgas@turvaja.ee  
 http://www.turvaja.ee  
 võõrkeeled: inglise, vene
- Juta-Maris UUSTALU**      **OÜ LASVET**  
 Suurtüki 4a, 10133 Tallinn  
 pk 3136, 10505 Tallinn  
 telefon: 6 40 66 00  
 telefaks: 6 40 66 04  
 e-post: lasvet@lasvet.ee  
 http://www.lasvet.ee  
 võõrkeeled: inglise, vene

**LIST OF PATENT ATTORNEYS, REGISTERED IN  
THE ESTONIAN STATE REGISTER OF PATENT ATTORNEYS  
(by 26 March 2003)**

Register is established on September 1<sup>st</sup> 2001

**FIELD OF ACTIVITY: TRADEMARKS, INDUSTRIAL DESIGNS AND GEOGRAPHICAL INDICATIONS**

<b>Arno ANIJALG</b>	<b>USTERVALL Ltd.</b> Raekoja plats 16 51004 Tartu P.O. Box 21 50002 Tartu, Estonia Phone: (372 7) 441 980 Fax: (372 7) 441 785 E-mail: anijalg@ustervall.ee Http://www.ustervall.ee German, Russian, Estonian	<b>Uno JÄÄGER</b>	<b>Patent Agency Käosaar &amp; Co</b> Rüütli 51A 80010 Pärnu, Estonia Phone: (372 44) 7 10 21 Fax: (372 44) 7 10 01 GSM: (372) 55 11 758 E-mail: uno@estpak.ee Http://www.kaosaar.ee English, Finnish, Russian, Estonian
<b>Aivo ARULA</b>	<b>Patent Agency Käosaar &amp; Co</b> Tähe Str. 94 50107 Tartu, Estonia Phone: (372 7) 383 051 Fax: (372 7) 383 055 E-mail: info@kaosaar.ee Http://www.kaosaar.ee English, Russian, Estonian	<b>Sirje KAHU</b>	<b>USTERVALL Ltd.</b> Raekoja plats 16 51004 Tartu P.O. Box 21 50002 Tartu, Estonia Phone: (372 7) 441 980 Fax: (372 7) 441 785 E-mail: skahu@ustervall.ee Http://www.ustervall.ee English, Russian, Estonian
<b>Martina BÖCKLER</b>	<b>Lasvet Ltd.</b> P.O. Box 3136, 10505 Tallinn, Estonia Phone: (372) 6 40 66 00 Fax: (372) 6 40 66 04 E-mail: lasvet@lasvet.ee Http://www.lasvet.ee English, Russian, Finnish, Estonian	<b>Lembit KALEV</b>	<b>Patent Bureau ROOSILLA Ltd.</b> Järveotsa Road 39-61 13520 Tallinn, Estonia Phone: (372) 657 1722; (372) 657 5381 Fax: (372) 657 5381 GSM: (372) 51 19 951 E-mail: roosilla@roosilla.ee Http://www.roosilla.ee English, Russian, Estonian
<b>Alla HÄMMALOV</b>	<b>Intels Ltd.</b> Riia Str. 11-3 51010 Tartu, Estonia Phone: (372 7) 42 04 01 Fax: (372 7) 42 03 26 E-mail: intelses@estpak.ee English, Polish, Russian, Estonian	<b>Urmas KAULER</b>	<b>Patendibüroo TURVAJA OÜ</b> Kaupmehe Str. 8 10114 Tallinn, Estonia Phone: (372) 6 40 31 09 Fax: (372) 6 40 31 05 E-mail: kauler@turvaja.ee Http://www.turvaja.ee English, Russian, Finnish, Estonian
<b>Juhan HÄMMALOV</b>	<b>Intels Ltd.</b> Riia Str. 11-3 51010 Tartu, Estonia Phone: (372 7) 42 04 01 Fax: (372 7) 42 03 26 E-mail: intelses@estpak.ee English, German, Russian, Estonian		

- Urmast KERNU**      **AAA Legal Services**  
Tartu Road 16  
10117 Tallinn, Estonia  
P.O. Box 3926  
10509 Tallinn, Estonia  
Phone: (372) 660 5910,  
(372) 660 5911  
Fax: (372) 660 5912  
E-mail: aaa@aaa.ee  
Http://www.aaa.ee  
English, German, Finnish,  
Russian, Estonian
- Mart-Enn KOPPEL**      Law Office Andrus Lillo  
Rüütli 14, 51007 Tartu, Estonia  
Phone: (372 7) 303 470;  
(372 7) 303 472  
Fax: (372 7) 303 471  
E-mail: martenn.koppel@mail.ee  
E-mail: mail@advokaadid.ee  
Http://www.advokaadid.ee/index\_en.htm  
English, Russian, Finnish,  
Estonian
- Marina KESSELMAN**      **Kesna Ltd.**  
Tedre Str. 77-52  
10616 Tallinn, Estonia  
Phone: (372) 6 608 068  
Fax: (372) 6 608 069  
E-mail: kesna@online.ee  
English, German, Russian,  
Estonian
- Heinu KOITEL**      **Patent- & Trademark Office  
Koitel Ltd.**  
Tartu Road 65  
10115 Tallinn  
P.O. Box 1759, 10902 Tallinn  
Phone: (372) 6 033 260  
Fax: (372) 6 033 261  
E-mail: koitel@koitel.ee  
Http://www.koitel.ee  
English, Finnish, Russian,  
Estonian
- Raivo KOITEL**      **Patent- & Trademark Office  
Koitel Ltd.**  
Tartu Road 65  
10115 Tallinn  
P.O. Box 1759, 10902 Tallinn  
Phone: (372) 6 033 260  
Fax: (372) 6 033 261  
E-mail: koitel@koitel.ee  
Http://www.koitel.ee  
English, Finnish, Russian,  
Estonian
- Heinrich KRUPP**      **Patendibüroo TURVAJA OÜ**  
Kaupmehe Str. 8  
10114 Tallinn, Estonia  
Phone: (372) 6 40 31 09  
Fax: (372) 6 40 31 05  
E-mail: turvaja@turvaja.ee  
Http://www.turvaja.ee  
German, Russian, Estonian
- Jüri KÄOSAAR**      **Patent Agency Käosaar & Co**  
Tähe Str. 94  
50107 Tartu, Estonia  
Phone: (372 7) 383 051  
Fax: (372 7) 383 055  
E-mail: info@kaosaar.ee  
Http://www.kaosaar.ee  
English, Russian, Estonian
- Reet MAASIKAMÄE**      **Patent Bureau Kaitsepurus  
Ltd.**  
Mulla Str. 4-3  
10611 Tallinn, Estonia  
Phone: (372) 6 739 097 &  
(372) 6 332 798  
Fax: (372) 6 774 844  
E-mail: purus@online.ee &  
purus@hot.ee  
Http://www.hot.ee/purus/  
English, Russian, Estonian
- Raivo MATSOO**      **RM Hirvela Patent Bureau  
Ltd**  
Saku 15, 11314 Tallinn  
Phone: (372) 6 140 816  
Fax: (372) 6 140 818  
E-mail: hirvela@online.ee  
English, Russian, Estonian
- Elle MELLIK**      **AAA Legal Services**  
Tartu Road 16  
10117 Tallinn, Estonia  
P.O. Box 3926  
10509 Tallinn, Estonia  
Phone: (372) 660 5910,  
(372) 660 5911  
Fax: (372) 660 5912  
E-mail: aaa@aaa.ee  
Http://www.aaa.ee  
English, Russian, Estonian

<b>Lembit MITT</b>	<b>AAA Legal Services</b> Tartu Road 16 10117 Tallinn, Estonia P.O. Box 3926 10509 Tallinn, Estonia Phone: (372) 660 5910, (372) 660 5911 Fax: (372) 660 5912 E-mail: aaa@aaa.ee Http://www.aaa.ee English, Russian, Estonian	<b>Jaak OSTRAT</b>	<b>Lasvet Ltd.</b> P.O. Box 3136, 10505 Tallinn, Estonia Phone: (372) 6 40 66 00 Fax: (372) 6 40 66 04 E-mail: lasvet@lasvet.ee Http://www.lasvet.ee English, German, Finnish, Russian, Estonian
<b>Ott MOORLAT</b>	<b>Moorlat &amp; Co Ltd.</b> <b>Patent Bureau</b> P.O. Box 723 12902 Tallinn, Estonia Phone: (372) 655 0450 & (372) 654 2844 Fax: (372) 654 2844 E-mail: ott.moorlat@moorlat.ee Http://www.moorlat.ee English, Russian, Estonian	<b>Villu PAVELTS</b>	<b>Lasvet Ltd.</b> P.O. Box 3136 10505 Tallinn, Estonia Phone: (372) 6 40 66 00 Fax: (372) 6 40 66 04 E-mail: lasvet@lasvet.ee Http://www.lasvet.ee English, Finnish, Russian, Estonian
<b>Anfia MORNA</b>	<b>Patendibüroo TURVAJA OÜ</b> Kaupmehe Str. 8 10114 Tallinn, Estonia Phone: (372) 6 40 31 09 Fax: (372) 6 40 31 05 E-mail: morna@turvaja.ee Http://www.turvaja.ee English, Russian, Estonian	<b>Anneli PUNGAS</b>	<b>Synest Ltd.</b> P.O. Box 977 13402 Tallinn, Estonia Phone: (372) 6 609 786 Fax: (372) 6 609 787 E-mail: anneli@synest.ee English, German, Russian, French, Finnish, Swedish, Estonian
<b>Tõnu NELSAS</b>	<b>AAA Legal Services</b> Tartu Road 16 10117 Tallinn, Estonia P.O. Box 3926 10509 Tallinn, Estonia Phone: (372) 660 5910, (372) 660 5911 Fax: (372) 660 5912 E-mail: aaa@aaa.ee Http://www.aaa.ee English, Russian, Finnish, Estonian	<b>Toom PUNGAS</b>	<b>Synest Ltd.</b> P.O. Box 977 13402 Tallinn, Estonia Phone: (372) 6 609 786 Fax: (372) 6 609 787 E-mail: toom@synest.ee English, German, Finnish, Russian, Estonian
<b>Jüri OLT</b>	<b>Patent Agency Käosaar &amp; Co</b> Tähe Str. 94 50107 Tartu, Estonia Phone: (372 7) 383 051 Fax: (372 7) 383 055 E-mail: info@kaosaar.ee Http://www.kaosaar.ee English, German, Finnish, Russian, Estonian	<b>Kaie PUUR</b>	<b>Patent Agency Käosaar &amp; Co</b> Tähe Str. 94 50107 Tartu, Estonia Phone: (372 7) 383 051 Fax: (372 7) 383 055 E-mail: info@kaosaar.ee Http://www.kaosaar.ee English, Russian, Estonian
		<b>Tarmo ROSMAN</b>	<b>Rosman and Partners Ltd.</b> P.O. Box 652 12602 Tallinn, Estonia Phone: (372) 656 14 50 Fax: (372) 656 14 50 E-mail: tarman@cc.ttu.ee German, English, Hungarian, Russian, Estonian

**Arvo SALUMÄE****AMENDE Patent Agency Ltd.**

Raua 65, 10152 Tallinn, Estonia  
Phone: (372) 6 486 125  
Fax: (372) 6 410 174  
E-mail: amende@hotmail.ee  
English, German, Finnish,  
Russian, Estonian

**Enn URGAS****Patendibüroo TURVAJA OÜ**

Kaupmehe Str. 8  
10114 Tallinn, Estonia  
Phone: (372) 6 40 31 09  
Fax: (372) 6 40 31 05  
E-mail: urgas@turvaja.ee  
Http://www.turvaja.ee  
English, Russian, Estonian

**Harald TEHVER****Patendibüroo TURVAJA OÜ**

Kaupmehe Str. 8  
10114 Tallinn, Estonia  
Phone: (372) 6 40 31 09  
Fax: (372) 6 40 31 05  
E-mail: tehver@turvaja.ee  
Http://www.turvaja.ee  
English, German, Russian,  
Estonian

**Juta-Maris UUSTALU****Lasvet Ltd.**

P.O. Box 3136  
10505 Tallinn, Estonia  
Phone: (372) 6 40 66 00  
Fax: (372) 6 40 66 04  
E-mail: lasvet@lasvet.ee  
Http://www.lasvet.ee  
English, Russian, Estonian

**Olga TREUFELDT****Patendibüroo TURVAJA OÜ**

Kaupmehe Str. 8  
10114 Tallinn, Estonia  
Phone: (372) 6 40 31 09  
Fax: (372) 6 40 31 05  
E-mail: olga@turvaja.ee  
Http://www.turvaja.ee  
English, Russian, Estonian

RIIKIDE, TEISTE ÜHENDUSTE JA VALITSUSTEVAAHELISTE  
ORGANISATSIOONIDE KOODID

AD	Andorra	CN	Hiina	GY	Guyana
AE	Araabia Ühendemiraadid	CO	Kolumbia	HK	Hongkong
AF	Afganistan	CR	Costa Rica	HN	Honduras
AG	Antigua ja Barbuda	CU	Kuuba	HR	Horvaatia
AI	Anguilla	CV	Cabo Verde	HT	Haiti
AL	Albaania	CY	Küpros	HU	Ungari
AM	Armeenia	CZ	Tšehhi	IB	Ülemaailmse Intellektuaalomandi
AN	Hollandi Antillid	DE	Saksamaa		Organisatsiooni (WIPO)
AO	Angola	DJ	Djibouti		Rahvusvaheline Büroo
AP	Aafrika Regionaalne Tööstusomandi Organisatsioon (ARIPO)	DK	Taani	ID	Indoneesia
AR	Argentina	DM	Dominica	IE	Iiri
AS	Ameerika Samoa	DO	Dominikaani Vabariik	IL	Iisrael
AT	Austria	DZ	Alžeeria	IM	Man'i saar
AU	Austraalia	EA	Euraasia Patendiorganisatsioon (EAPO)	IN	India
AW	Aruba	EC	Ecuador	IQ	Iraak
AZ	Aserbaidžaan	EE	Eesti	IR	Iraan
BA	Bosnia ja Hertsegoviina	EG	Egiptus	IS	Island
BB	Barbados	EH	Lääne-Sahara	IT	Itaalia
BD	Bangladesh	EM	Siseturu Ühtlustamise Amet (kaubamärgid ja tööstusdisainilahendused)	JM	Jamaica
BE	Belgia	EP	Euroopa Patendiamet (EPO)	JO	Jordaanias
BF	Burkina Faso	ER	Eritrea	JP	Jaapan
BG	Bulgaaria	ES	Hispaania	KE	Kenya
BH	Bahrein	ET	Etiopia	KG	Kõrgõzstan
BI	Burundi	FI	Soome	KH	Kambodža
BJ	Benin	FJ	Fidži	KI	Kiribati
BM	Bermuda	FK	Falklandi (Malviini) saared	KM	Komoorid
BN	Brunei	FM	Mikroneesia	KN	Saint Kitts ja Nevis
BO	Boliivia	FO	Fääri saared	KP	Põhja-Korea
BR	Brasiilia	FR	Prantsusmaa	KR	Lõuna-Korea
BS	Bahama	GA	Gabon	KW	Kuveit
BT	Bhutan	GB	Ühendkuningriik (Suurbritannia)	KY	Kaimanisaared
BV	Bouvet' saar	GD	Grenada	KZ	Kasahstan
BW	Botswana	GE	Gruusia	LA	Laos
BX	Beneluxi Kaubamärgiamet (BBM) ja Beneluxi Tööstusdisaini- lahenduste Amet (BBDM)	GH	Ghana	LB	Liibanon
BY	Valgevene	GI	Gibraltar	LC	Saint Lucia
BZ	Belize	GL	Gröönimaa	LI	Liechtenstein
CA	Kanada	GM	Gambia	LK	Sri Lanka
CF	Kesk-Aafrika Vabariik	GN	Guinea	LR	Libeeria
CG	Kongo	GQ	Ekvatoriaal-Guinea	LS	Lesotho
CH	Šveits	GR	Kreeka	LT	Leedu
CI	Côte d'Ivoire	GS	Lõuna-Georgia ja Lõuna-Sandwichi saared	LU	Luksemburg
CK	Cooki saared	GT	Guatemala	LV	Läti
CL	Tšiili	GW	Guinea-Bissau	LY	Liibüa
CM	Kamerun			MA	Maroko
				MC	Monaco
				MD	Moldova
				MG	Madagaskar
				MH	Marshalli Saared
				MK	Makedoonia
				ML	Mali
				MM	Myanmaar (Birma)
				MN	Mongoolia

MO	Macao	PW	Belau	TO	Tonga
MP	Põhja-Mariaanid	PY	Paraguay	TL	Ida-Timor
MR	Mauritaania	QA	Katar	TR	Türgi
MS	Montserrat	RO	Rumeenia	TT	Trinidad ja Tobago
MT	Malta	RU	Venemaa	TV	Tuvalu
MU	Mauritius	RW	Rwanda	TW	Taiwan (Hiina provints)
MV	Maldiivid	SA	Saudi Araabia	TZ	Tansaania
MW	Malawi	SB	Saalomoni Saared	UA	Ukraina
MX	Mehhiko	SC	Seišellid	UG	Uganda
MY	Malaisia	SD	Sudaan	US	Ameerika Ühendriigid
MZ	Mosambiik	SE	Rootsi	UY	Uruguay
NA	Namiibia	SG	Singapur	UZ	Usbekistan
NE	Niger	SH	Saint Helena	VA	Vatikan (Püha Tool)
NG	Nigeeria	SI	Sloveenia	VC	Saint Vincent ja Grenadiinid
NI	Nicaragua	SK	Slovakkia	VE	Venezuela
NL	Holland	SL	Sierra Leone	VG	Neitsisaared
NO	Norra	SM	San Marino	VN	Vietnam
NP	Nepal	SN	Senegal	VU	Vanuatu
NR	Nauru	SO	Somaalia	WO	Ülemaailmne Intellektuaalomandi Organisatsioon (WIPO) (Rahvusvaheline Büroo)
NZ	Uus-Meremaa	SR	Suriname	WS	Samoa
OA	Aafrika Intellektuaalomandi Organisatsioon (OAPI)	ST	São Tomé ja Príncipe	YE	Jeemen
OM	Omaan	SV	El Salvador	YU	Jugoslaavia
PA	Panama	SY	Süüria	ZA	Lõuna-Aafrika Vabariik
PE	Peruu	SZ	Svaasimaa	ZM	Sambia
PG	Paapua Uus-Guinea	TC	Turks ja Caicos	ZR	Zaire
PH	Filipiinid	TD	Tšaad	ZW	Zimbabwe
PK	Pakistan	TG	Togo		
PL	Poola	TH	Tai		
PT	Portugal	TJ	Tadžikistan		
		TM	Türkmenistan		
		TN	Tuneesia		