



EESTI VABARIIK

T **EESTI**
TÖÖSTUSDISAINI-
LAHENDUSE LEHT



PATENDIAMETI AMETLIK VÄLJAANNE

4
2006
TALLINN



ISSN 1406-376X

EESTI VABARIIK

T **EESTI**
TÖÖSTUSDISAINI-
LAHENDUSE LEHT

**PATENDIAMETI
AMETLIK VÄLJAANNE**

IX aastakäik

**Käesolevas numbris
esitatud andmed
loetakse avaldatuks
15. novembril 2006. a.**

4
2006
NOVEMBER
TALLINN

Eesti Tööstusdisainilahenduse Lehte antakse välja tööstusdisaini kaitse seaduse (jõustunud 11.01.1998) alusel.
The Estonian Industrial Design Gazette is the official publication of the Estonian Patent Office.
Published under Industrial Design Protection Law of the Republic of Estonia (coming into force 11 January 1998).
Date of publication of the data presented in this issue - 15 November 2006.

Patendiameti
infoosakond
Toompuiestee 7
15041 Tallinn
Tel 627 7907
Faks 627 7943
E-post Info@epa.ee

The Information Department
of the Estonian Patent Office
Toompuiestee 7
15041 Tallinn, ESTONIA
Phone +372 627 7907
Fax +372 627 7943
E-mail Info@epa.ee

Levitaja

Eesti Patendiraamatukogu
Olevimägi 8/10
10123 Tallinn
Tel 641 1248
Faks 641 1018
E-post patent@patentlib.ee

Distributor

Estonian Patent Library
Olevimägi 8/10
10123 Tallinn, ESTONIA
Phone +372 641 1248
Fax +372 641 1018
E-mail patent@patentlib.ee

SISUKORD

Andmete identifitseerimise rahvusvahelised numberkoodid (INID-koodid)	4
Riikide, teiste ühenduste ja valitsustevaheliste organisatsioonide koodid	5
I. REGISTREERITUD TÖÖSTUSDISAINILAHENDUSED	6
II. RAHVUSVAHELISELT REGISTREERITUD TÖÖSTUSDISAINILAHENDUSED	40
III. REGISTREERINGU KEHTIVUSE PIKENDAMINE	105
IV. TÖÖSTUSDISAINILAHENDUSE ÜLEMINEK	105
V. REGISTREERINGU JAGAMINE	-
VI. MUUD REGISTREERINGU ANDMETE MUUDATUSED	105
VII. REGISTREERINGU ANDMETE PARANDUSED	-
VIII. TÖÖSTUSDISAINILAHENDUSE LITSENTSIDE REGISTREERIMINE	-
IX. TÖÖSTUSDISAINILAHENDUSE PANTIDE REGISTREERIMINE	-
X. TUNNISTUSE DUPLIKAADI VÄLJAANDMINE	-
XI. TÖÖSTUSDISAINILAHENDUSE KUSTUTAMINE REGISTRIST	105
XII. LOENDID	106
Registreeritud tööstusdisainilahenduste süstemaatiline loend	106
Registreeritud tööstusdisainilahenduste registreerimistaotluste numbriline loend	106
Avaldatud rahvusvahelise registreeringu registreerimise otsuse teadete numbriline loend	107
XIII. TÖÖSTUSDISAINIALASED ÕIGUSAKTID JA MUU INFO	108
Riiklikus patendivolinike registris registreeritud patendivolinike nimekiri	108

CONTENTS

Internationally Agreed Numbers for the Identification of Data (INID Codes)	4
List of Codes of States, Other Entities and Intergovernmental Organizations	5
I. REGISTERED INDUSTRIAL DESIGNS	6
II. INTERNATIONALLY REGISTERED INDUSTRIAL DESIGNS	40
III. EXTENSION OF THE REGISTRATION	105
IV. TRANSFER OF INDUSTRIAL DESIGN	105
V. DIVISION OF THE REGISTRATION.	-
VI. OTHER AMENDMENTS TO REGISTRATION DATA	105
VII. CORRECTIONS TO REGISTRATION DATA	-
VIII. REGISTERING OF LICENSES OF INDUSTRIAL DESIGN	-
IX. REGISTERING OF PLEDGES OF INDUSTRIAL DESIGN	-
X. ISSUE OF A COPY OF THE INDUSTRIAL DESIGN CERTIFICATE	-
XI. DELETION OF INDUSTRIAL DESIGN FROM THE REGISTER	105
XII. LISTS	106
Systematic List of Registered Industrial Designs	106
Numerical List of Registration Applications of Registered Industrial Designs	106
Numerical List of Published Notices of Decisions on Registration of the International Registration	107
XIII. LEGAL ACTS AND INFORMATION CONCERNING INDUSTRIAL DESIGNS	108
List of Patent Attorneys, Registered in the Estonian State Register of Patent Attorneys	112

**ANDMETE IDENTIFITSEERIMISE
RAHVUSVAHELISED NUMBERKOODID
(INID-KOODID)
WIPO Standard ST. 80**

**INTERNATIONALLY AGREED NUMBERS FOR
THE IDENTIFICATION OF DATA
(INID CODES)
WIPO Standard ST. 80**

(11) Registreeringu number	(11) Number of the Registration
(15) Registreerimise kuupäev	(15) Date of the Registration
(18) Registreeringu kehtivuse lõppemise kuupäev	(18) Expected expiration date of the registration
(21) Registreerimistaotluse number	(21) Application Number
(22) Registreerimistaotluse esitamise kuupäev	(22) Application Filing Date
(24) Registreeringu kehtivuse alguse kuupäev	(24) Date from which the Industrial Design right has effected
(28) Variantide arv	(28) Number of Industrial Designs included in the application
(30) Prioriteet	(30) Priority
(51) Rahvusvahelise klassifikatsiooni klassi ja alaklassi number	(51) International Classification for Industrial Designs (class and subclass of the Locarno Classification)
(54) Tööstusdisainilahenduse nimetus	(54) Title of the Industrial Design
(55) Tööstusdisainilahenduse reproduktsioon	(55) Reproduction of the Industrial Design
(72) Tööstusdisainilahenduse autor(id)	(72) Author(s) of Industrial Design
(73) Tööstusdisainilahenduse omanik(ud)	(73) Proprietor(s) of Industrial Design
(74) Patendivolinik või ühine esindaja	(74) Patent Attorney or Common Representative

**RIIKIDE, TEISTE ÜHENDUSTE JA VALITSUSTEVAAHELISTE
ORGANISATSIOONIDE KOODID**

AD	Andorra	DO	Dominikaani	IS	Island	PK	Pakistan
AE	Araabia		Vabariik	IT	Itaalia	PL	Poola
	Ühendemiraadid	DZ	Alžeeria	JE	Jersey	PT	Portugal
AF	Afganistan	EA	Euraasia	JM	Jamaica	PW	Belau
AG	Antigua ja Barbuda		Patendiorganisat-	JO	Jordaania	PY	Paraguay
AI	Anguilla		sioon (EAPO)	JP	Jaapan	QA	Katar
AL	Albaania	EC	Ecuador	KE	Kenya	RO	Rumeenia
AM	Armeenia	EE	Eesti	KG	Kõrgõzstan	RU	Venemaa
AN	Hollandi Antillid	EG	Egiptus	KH	Kambodža	RW	Rwanda
AO	Angola	EH	Lääne-Sahara	KI	Kiribati	SA	Saudi Araabia
AP	Aafrika Regionaalne	EM	Siseturu	KM	Komoorid	SB	Saalomoni Saared
	Tööstusomandi Orga-		Ühtlustamise	KN	Saint Kitts ja Nevis	SC	Seišellid
	nisatsioon (ARIPO)		Amet (kaubamärgid	KP	Põhja-Korea	SD	Sudaan
AR	Argentina		ja tööstusdisaini-	KR	Lõuna-Korea	SE	Rootsi
AS	Ameerika Samoa		lahendused)(OHIM)	KW	Kuveit	SG	Singapur
AT	Austria	EP	Euroopa	KY	Kaimanisaared	SH	Saint Helena
AU	Austraalia		Patendiamet (EPO)	KZ	Kasahstan	SI	Sloveenia
AW	Aruba	ER	Eritrea	LA	Laos	SK	Slovakkia
AZ	Aserbaidžaan	ES	Hispaania	LB	Liibanon	SL	Sierra Leone
BA	Bosnia ja	ET	Etiopia	LC	Saint Lucia	SM	San Marino
	Hertsegoviina	FI	Soome	LI	Liechtenstein	SN	Senegal
BB	Barbados	FJ	Fidži	LK	Sri Lanka	SO	Somaalia
BD	Bangladesh	FK	Falklandi (Malviini)	LR	Libeeria	SR	Suriname
BE	Belgia		saared	LS	Lesotho	ST	São Tomé ja Príncipe
BF	Burkina Faso	FM	Mikroneesia	LT	Leedu	SV	El Salvador
BG	Bulgaaria	FO	Fääri saared	LU	Luksemburg	SY	Süüria
BH	Bahrein	FR	Prantsusmaa	LV	Läti	SZ	Svaasimaa
BI	Burundi	GA	Gabon	LY	Liibüa	TC	Turks ja Caicos
BJ	Benin	GB	Ühendkuningriik	MA	Maroko	TD	Tšaad
BM	Bermuda		(Suurbritannia)	MC	Monaco	TG	Togo
BN	Brunei	GC	Pärsia Lahe	MD	Moldova	TH	Tai
BO	Boliivia		Koostöönõukogu	MG	Madagaskar	TJ	Tadžikistan
BR	Brasiilia	GD	Grenada	MH	Marshalli Saared	TM	Türkmenistan
BS	Bahama	GE	Gruusia	MK	Makedoonia	TN	Tuneesia
BT	Bhutan	GG	Guernsey	ML	Mali	TO	Tonga
BV	Bouvet' saar	GH	Ghana	MM	Myanmar (Birma)	TL	Ida-Timor
BW	Botswana	GI	Gibraltar	MN	Mongoolia	TR	Türgi
BX	Beneluxi	GL	Gröönimaa	MO	Macao	TT	Trinidad ja Tobago
	Kaubamärgiamet	GM	Gambia	MP	Põhja-Mariaanid	TV	Tuvalu
	(BBM) ja Beneluxi	GN	Guinea	MR	Mauritaania	TW	Taiwan (Hiina provints)
	Tööstusdisainilahen-	GQ	Ekvatoriaal-Guinea	MS	Montserrat	TZ	Tansaania
	duste Amet (BBDM)	GR	Kreeka	MT	Malta	UA	Ukraina
BY	Valgevene	GS	Lõuna-Georgia ja	MU	Mauritius	UG	Uganda
BZ	Belize		Lõuna-Sandwichi	MV	Maldiivid	US	Ameerika
CA	Kanada		saared	MW	Malawi		Ühendriigid
CF	Kesk-Aafrika	GT	Guatemala	MX	Mehhiko	UY	Uruguay
	Vabariik	GW	Guinea-Bissau	MY	Malaisia	UZ	Usbekistan
CG	Kongo	GY	Guyana	MZ	Mosambiik	VA	Vatikan (Püha Tool)
CH	Šveits	HK	Hongkong	NA	Namiibia	VC	Saint Vincent ja
CI	Côte d'Ivoire	HN	Honduras	NE	Niger		Grenadiinid
CK	Cooki saared	HR	Horvaatia	NG	Nigeeria	VE	Venezuela
CL	Tšiili	HT	Haiti	NI	Nicaragua	VG	Neitsisaared
CM	Kamerun	HU	Ungari	NL	Holland	VN	Vietnam
CN	Hiina	IB	Ülemaailmse	NO	Norra	VU	Vanuatu
CO	Kolumbia		Intellektuaalomandi	NP	Nepal	WO	Ülemaailmne
CR	Costa Rica		Organisatsiooni	NR	Nauru		Intellektuaalomandi
CS	Serbia ja Montenegro		(WIPO) Rahvus-	NZ	Uus-Meremaa		Organisatsioon
CU	Kuuba		vaheline Büroo	OA	Aafrika Intellektuaal-		(WIPO) (Rahvus-
CV	Cabo Verde	ID	Indoneesia		omandi Organisat-		vaheline Büroo)
CY	Küpros	IE	Iiri		sioon (OAPI)	WS	Samoa
CZ	Tšehhi	IL	Iisrael	OM	Omaan	YE	Jeemen
DE	Saksamaa	IM	Man'i saar	PA	Panama	ZA	Lõuna-Aafrika Vabariik
DJ	Djibouti	IN	India	PE	Peruu	ZM	Sambia
DK	Taani	IQ	Iraak	PG	Paapua Uus-Guinea	ZR	Zaire
DM	Dominica	IR	Iraan	PH	Filipiinid	ZW	Zimbabwe

I. REGISTREERITUD TÖÖSTUSDISAINILAHENDUSED

Avaldatakse "Tööstusdisaini kaitse seaduse" § 55¹ lõike 7 alusel.

Patendiamet ei ole kontrollinud tööstusdisainilahenduse uudsust ja eristatavust tulenevalt "Tööstusdisaini kaitse seaduse" § 31 lõike 2 punktist 1.

- (11) **Registreeringu number** **01173** (51) Klass: **09-01**
- (21) **Taotluse number** D200500093
- (15) **Registreerimise päev** 15.11.2006
- (22) **Esitamise päev** 30.12.2005
- (24) **Registreeringu kehtivuse alguse päev** 30.12.2005
- (18) **Registreeringu kehtivuse lõppemise päev** 30.12.2010
- (28) **Variantide arv** 1
- (72) **Autor** Denis Prasolov, ul. Tikhoretskaya, d.9, 350059 g. Krasnodar, RU
- (73) **Omanik** Obschestvo s organichennoi otvetstvennostyu "Gruppa Kompanii "Rusargo"", ul. Garibaldi, d. 23, korp. 4, 117335 Moscow, RU
- (74) **Patendivolinik või ühine esindaja** Toom Pungas

(54) **Nimetus** **Taimeõlipudel**

(55) **Reproduktsoon**

01173-01



- (11) **Registreeringu number** **01174** (51) Klass: **14-03**
- (21) **Taotluse number** D200600015
- (15) **Registreerimise päev** 15.11.2006
- (22) **Esitamise päev** 20.03.2006
- (24) **Registreeringu kehtivuse alguse päev** 20.03.2006
- (18) **Registreeringu kehtivuse lõppemise päev** 20.03.2011
- (28) **Variantide arv** 1
- (30) **Prioriteediandmed** 29/239,899, 06.10.2005, US
- (72) **Autor** Dimitre D. Mehandjiysky, 3535 East 1st Street, Belmont Shore, California 90803, US
 Tanja Fisher, 40B Strawberry Hill Road, Twickenham, Middlesex TW1 4PU, GB
 Tej Chauhan, 109 Beverley Drive, Edgware, Middlesex HA8 5NH, GB
 Helin Totti, Köydenpunojankatu 7 B 21, 00180 Helsinki, FI
 Grace Boicel, 105 a Sheen Lane, SW14 8AE London, FI
 Valerie Pegon, 13B Sheen Lane, East Sheen, London SW14 8HY, GB
- (73) **Omanik** Nokia Corporation, Keilalahdentie 4, FIN-02150 Espoo, FI
- (74) **Patendivolinik või ühine esindaja** Kalev Käosaar

(54) **Nimetus** **Käsitelefon**

(55) **Reproduktsoon**

01174-01

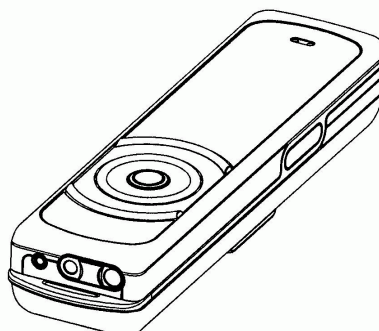
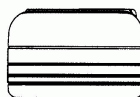
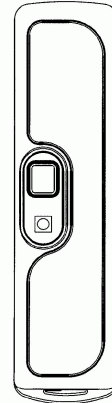
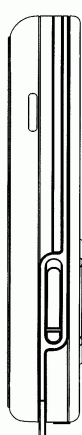
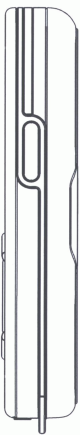

- (11) **Registreeringu number** **01175** (51) Klass: **14-03**
- (21) **Taotluse number** D200600022
- (15) **Registreerimise päev** 15.11.2006
- (22) **Esitamise päev** 05.04.2006
- (24) **Registreeringu kehtivuse alguse päev** 05.04.2006
- (18) **Registreeringu kehtivuse lõppemise päev** 05.04.2011
- (28) **Variantide arv** 1
- (30) **Prioriteediandmed** 29/240,007, 07.10.2005, US
- (72) **Autor** Dimitre D. Mehandjiysky, 3535 East 1st Street, Belmont Shore, California 90803, US
Tanja Fisher, 40B Strawberry Hill Road, Twickenham, Middlesex TW1 4PU, GB
Tej Chauhan, 109 Beverley Drive, Edgware, Middlesex HA8 5NH, GB
Totti Helin, Köydenpunojankatu 7 B 21, 00180 Helsinki, FI
Grace Boicel, 105 a Sheen Lane, SW14 8AE London, FI
Valerie Pegon, 13B Sheen Lane, East Sheen, London SW14 8HY, GB
- (73) **Omanik** Nokia Corporation, Keilalahdentie 4, FIN-02150 Espoo, FI
- (74) **Patendivolinik või ühine esindaja** Jüri Käosaar

(54) **Nimetus** **Käsitelefon**

(55) **Reproduktsoon**

01175-01

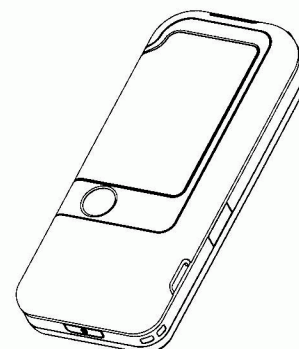
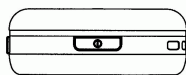
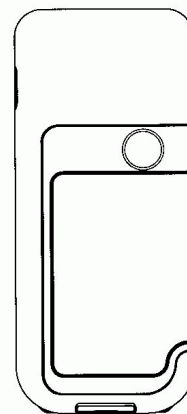
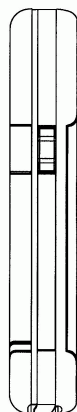
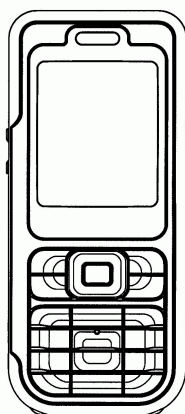
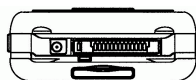

- (11) **Registreeringu number** **01176** (51) Klass: **10-04, 10-05, 10-06, 12-07, 14-03**
- (21) **Taotluse number** D200600028
- (15) **Registreerimise päev** 15.11.2006
- (22) **Esitamise päev** 10.05.2006
- (24) **Registreeringu kehtivuse alguse päev** 10.05.2006
- (18) **Registreeringu kehtivuse lõppemise päev** 10.05.2011
- (28) **Variantide arv** 2
- (72) **Autor** Leino Vint, Kadaka tee 113 A, 12915 Tallinn, EE
Matti Veigel, Kadaka tee 113A, 12915 Tallinn, EE
- (73) **Omanik** AS Laser Diagnostic Instruments, Kadaka tee 113 a, 12915 Tallinn, EE
- (74) **Patendivolinik või ühine esindaja** Ott Moorlat
- (54) **Nimetus** **Skaneeriv lennulidar**

(55) **Reproduktsoon**

01176-01

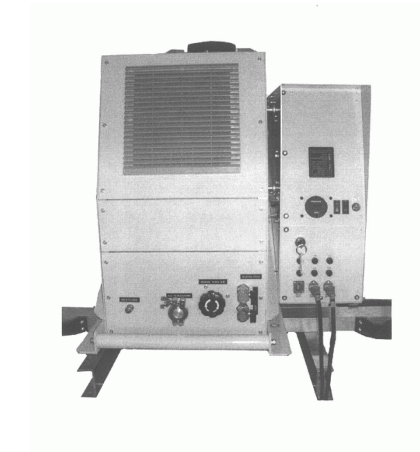
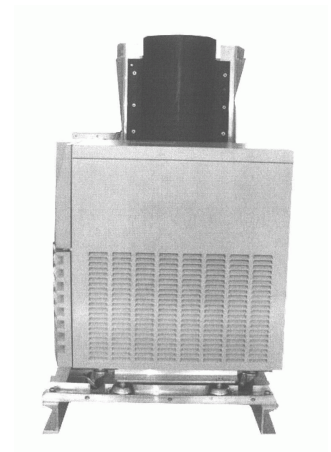
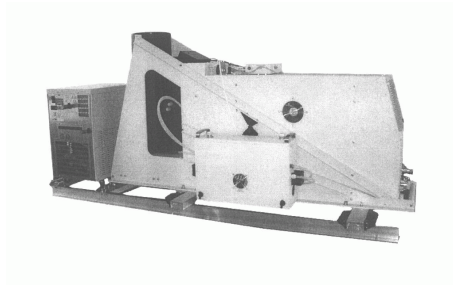
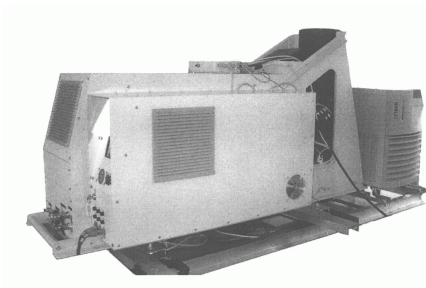

01176-02

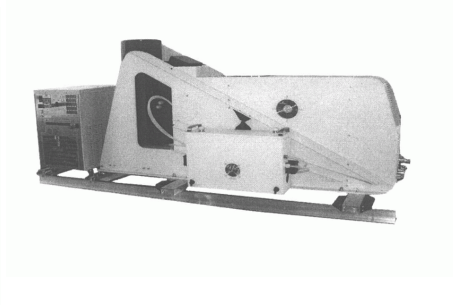
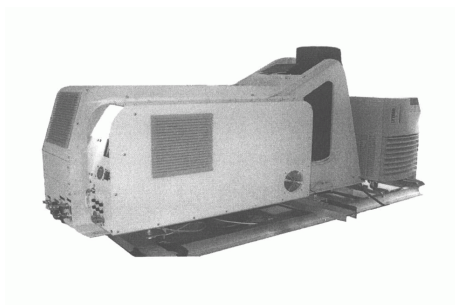

- (11) **Registreeringu number** **01177**
- (21) **Taotluse number** D200600031
- (15) **Registreerimise päev** 15.11.2006
- (22) **Esitamise päev** 11.05.2006
- (24) **Registreeringu kehtivuse alguse päev** 11.05.2006
- (18) **Registreeringu kehtivuse lõppemise päev** 11.05.2011
- (28) **Variantide arv** 3
- (72) **Autor** Janno Roos, Niine 11, 10414 Tallinn, EE
Andres Labi, Niine 11, 10414 Tallinn, EE
- (73) **Omanik** Ruumilabor OÜ, Niine 11, 10414 Tallinn, EE
- (74) **Patendivolinik või ühine esindaja** Ott Moorlat

(51) Klass: **06-11, 06-12**

(54) **Nimetus** **Vaip**

(55) **Reproduktsoon**

01177-01

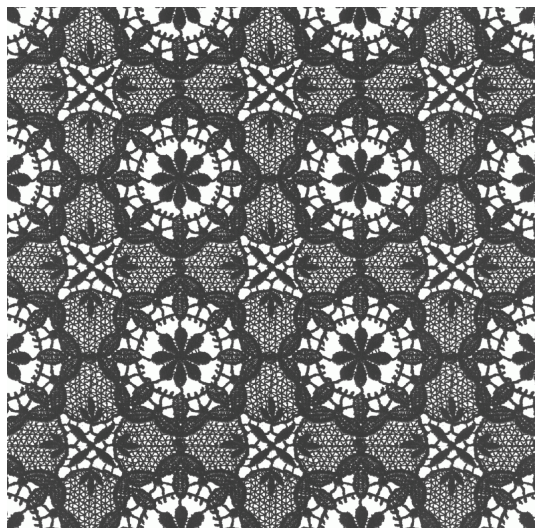

01177-02

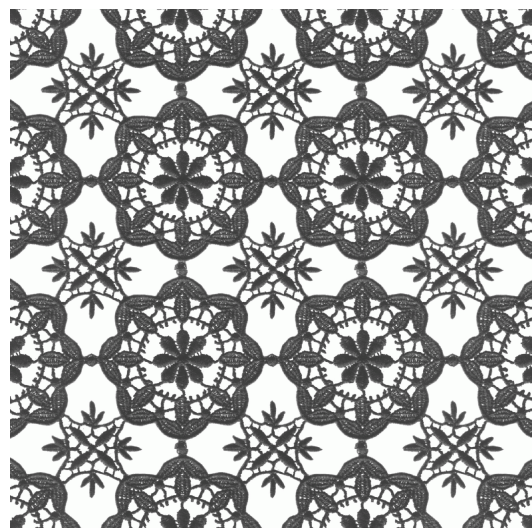

01177-03

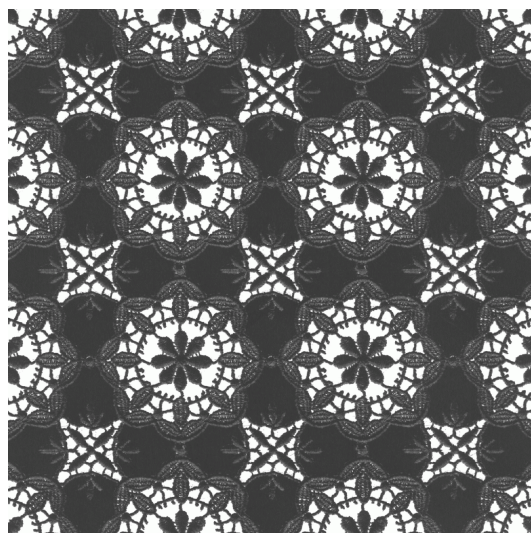

(11) **Registreeringu number** **01178**

(51) Klass: **11-02**

(21) **Taotluse number** D200600033

(15) **Registreerimise päev** 15.11.2006

(22) **Esitamise päev** 19.05.2006

(24) **Registreeringu kehtivuse alguse päev** 19.05.2006

(18) **Registreeringu kehtivuse lõppemise päev** 19.05.2011

(28) **Variantide arv** 1

(72) **Autor** Feliks Tammi, Linnamäe tee 79-2, 13911 Tallinn, EE

(73) **Omanik** Feliks Tammi, Linnamäe tee 79-2, 13911 Tallinn, EE

(54) **Nimetus** **Keraamiline alus vaasiga**

(55) **Reproduktsoon**

01178-01

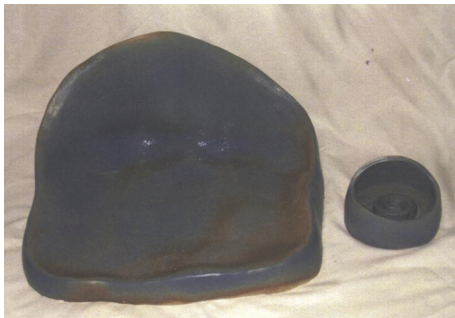

(11) Registreeringu number	01179	(51) Klass: 15-03
(21) Taotluse number	D200600034	
(15) Registreerimise päev	15.11.2006	
(22) Esitamise päev	25.05.2006	
(24) Registreeringu kehtivuse alguse päev	25.05.2006	
(18) Registreeringu kehtivuse lõppemise päev	25.05.2011	
(28) Variantide arv	4	
(30) Prioriteediandmed	D200600007, 22.02.2006, EE	
(72) Autor	Marcus Ingemarsson, Lilla Tjärby Gård, SE-312 91 Laholm, SE Mikael Tarland, Hunnebergsgatan 39, SE-582 34 Linköping, SE	
(73) Omanik	Väderstad-Verken AB, Box 85, SE-590 21 Väderstad, SE	
(74) Patendivolinik või ühine esindaja	Jaak Ostrat	

(54) Nimetus **Põllutöömasina tera**

(55) Reproduksioon

01179-01



01179-02

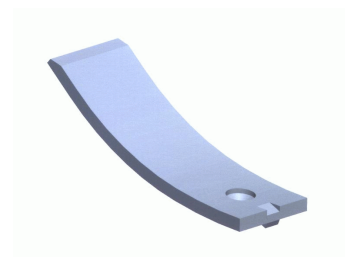
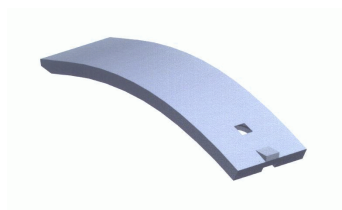

01179-03

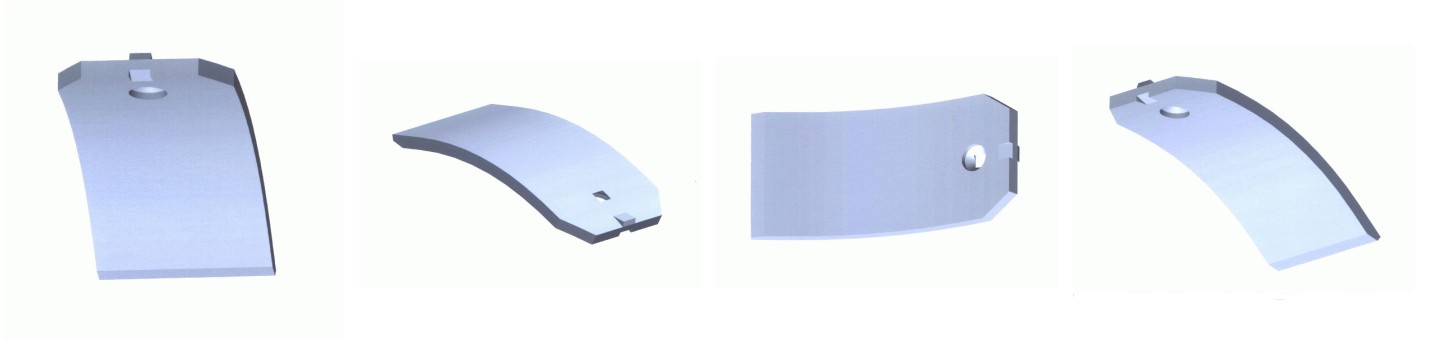

01179-04

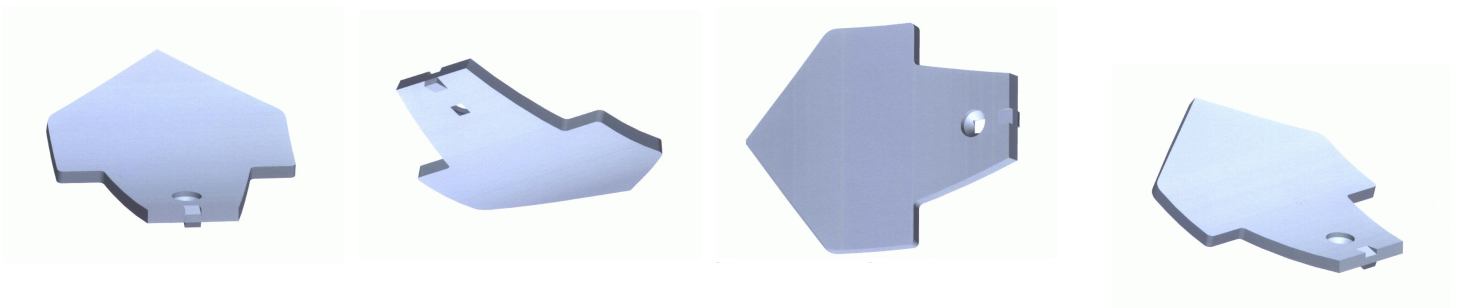

- (11) **Registreeringu number** **01180** (51) Klass: **19-04**
- (21) **Taotluse number** D200600039
- (15) **Registreerimise päev** 15.11.2006
- (22) **Esitamise päev** 31.05.2006
- (24) **Registreeringu kehtivuse alguse päev** 31.05.2006
- (18) **Registreeringu kehtivuse lõppemise päev** 31.05.2011
- (28) **Variantide arv** 3
- (72) **Autor** Priit Pöldme, Kolde pst. 84-55, 10321 Tallinn, EE
Tiiu Pirsko, Kalda 64-2, 10922 Tallinn, EE
- (73) **Omanik** Eesti Sisearhitektide Liit, Suur Kloostri 11A, 10133 Tallinn, EE
- (74) **Patendivolinik või ühine esindaja** Ott Moorlat

(54) **Nimetus** **Aastaraamat**

(55) **Reproduksioon**

01180-01



01180-02

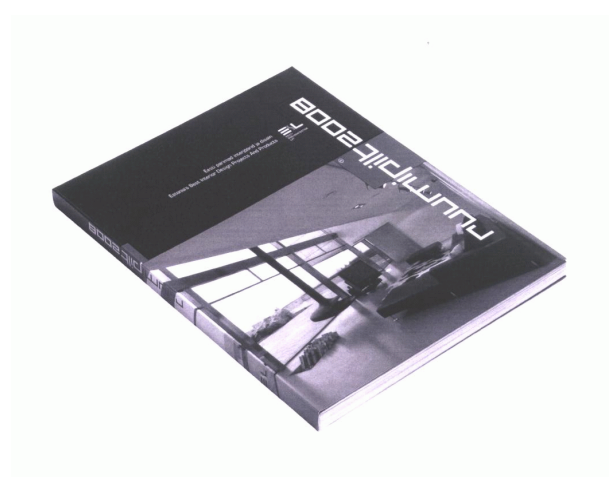

01180-03



(11) Registreeringu number	01181	(51) Klass: 14-03
(21) Taotluse number	D200600021	
(15) Registreerimise päev	15.11.2006	
(22) Esitamise päev	05.04.2006	
(24) Registreeringu kehtivuse alguse päev	05.04.2006	
(18) Registreeringu kehtivuse lõppemise päev	05.04.2011	
(28) Variantide arv	1	
(30) Prioriteediandmed	29/240,009, 07.10.2005, US	
(72) Autor	Dimitre D. Mehandjiysky, 3535 East 1st Street, Belmont Shore, California 90803, US Tanja Fisher, 40B Strawberry Hill Road, Twickenham, Middlesex TW1 4PU, GB Tej Chauhan, 109 Beverley Drive, Edgware, Middlesex HA8 5NH, GB Totti Helin, Köydenpunojankatu 7 B 21, 00180 Helsinki, FI Grace Boicel, 105 a Sheen Lane, SW14 8AE London, FI Valerie Pegon, 13B Sheen Lane, East Sheen, London SW14 8HY, GB	
(73) Omanik	Nokia Corporation, Keilalahdentie 4, FIN-02150 Espoo, FI	
(74) Patendivolinik või ühine esindaja	Jüri Käosaar	

(54) **Nimetus** **Käsitelefon**

(55) **Reproduktsoon**

01181-01

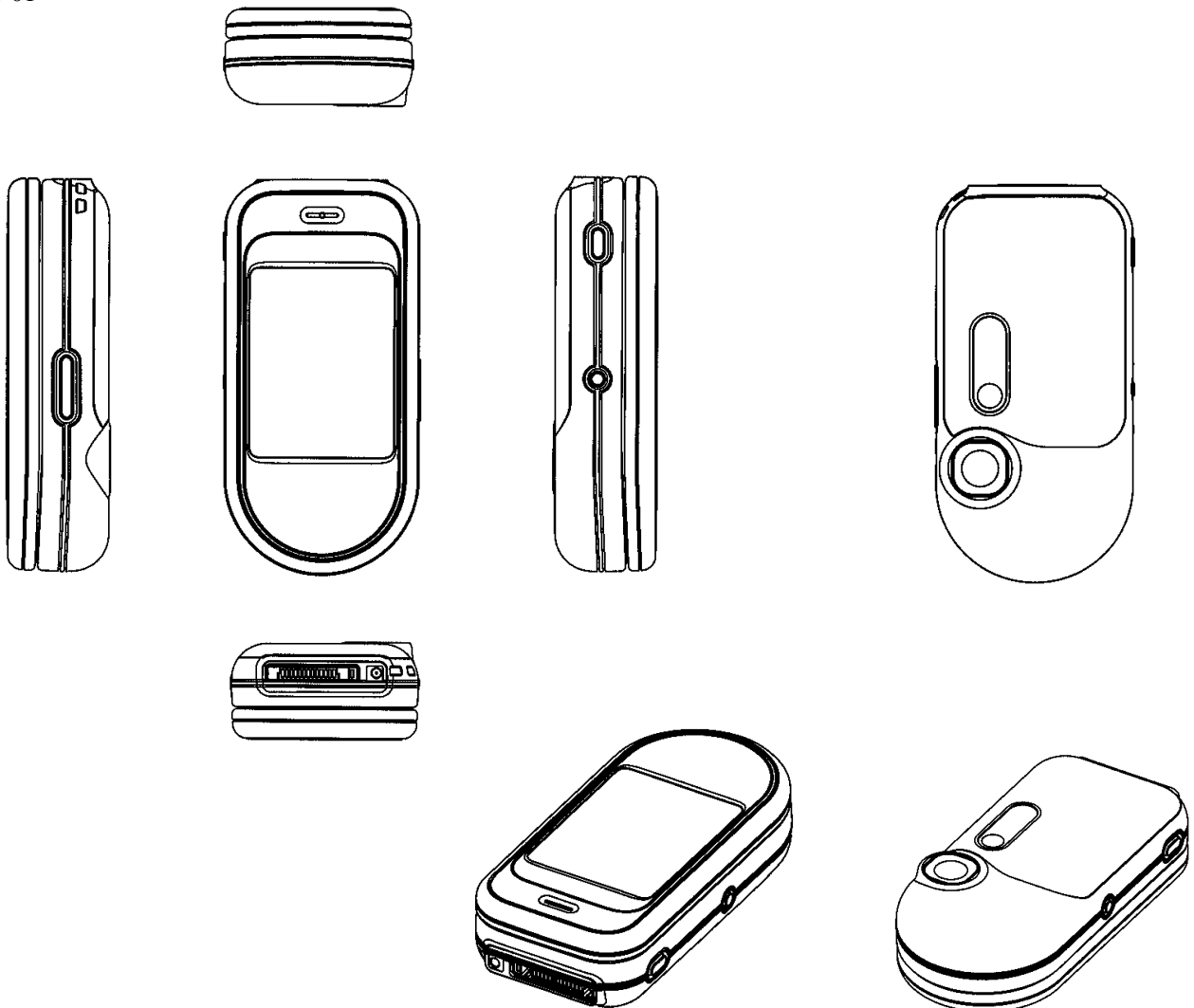

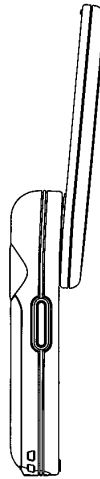
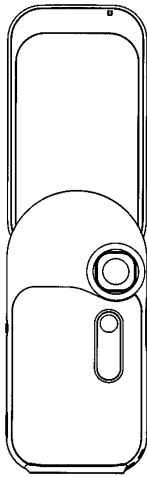
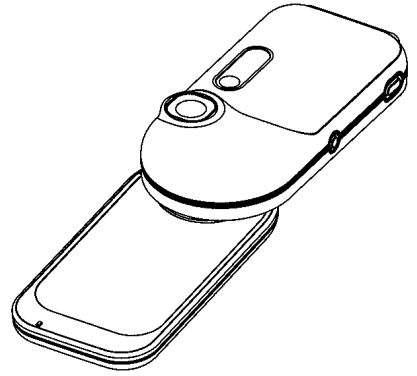
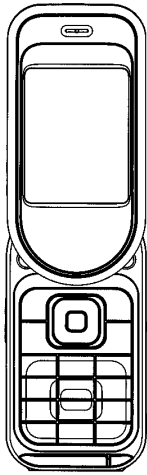

(11) **Registreeringu number** **01182**

(51) Klass: **14-03**

(21) **Taotluse number** D200600044

(15) **Registreerimise päev** 15.11.2006

(22) **Esitamise päev** 30.06.2006

(24) **Registreeringu kehtivuse
alguse päev** 30.06.2006

(18) **Registreeringu kehtivuse
lõppemise päev** 30.06.2011

(28) **Variantide arv** 1

(30) **Prioriteediandmed** M20060005, 05.01.2006, FI

(72) **Autor** Niilo Alfthan, Rautatiekatu 2 B 3, 33100 Tampere, FI

(73) **Omanik** Nokia Corporation, Keilalahdentie 4, FIN-02150 Espoo, FI

(74) **Patendivolinik või ühine esindaja** Kaie Puur

(54) **Nimetus** **Käsitelefon**

(55) **Reproduktsoon**

01182-01

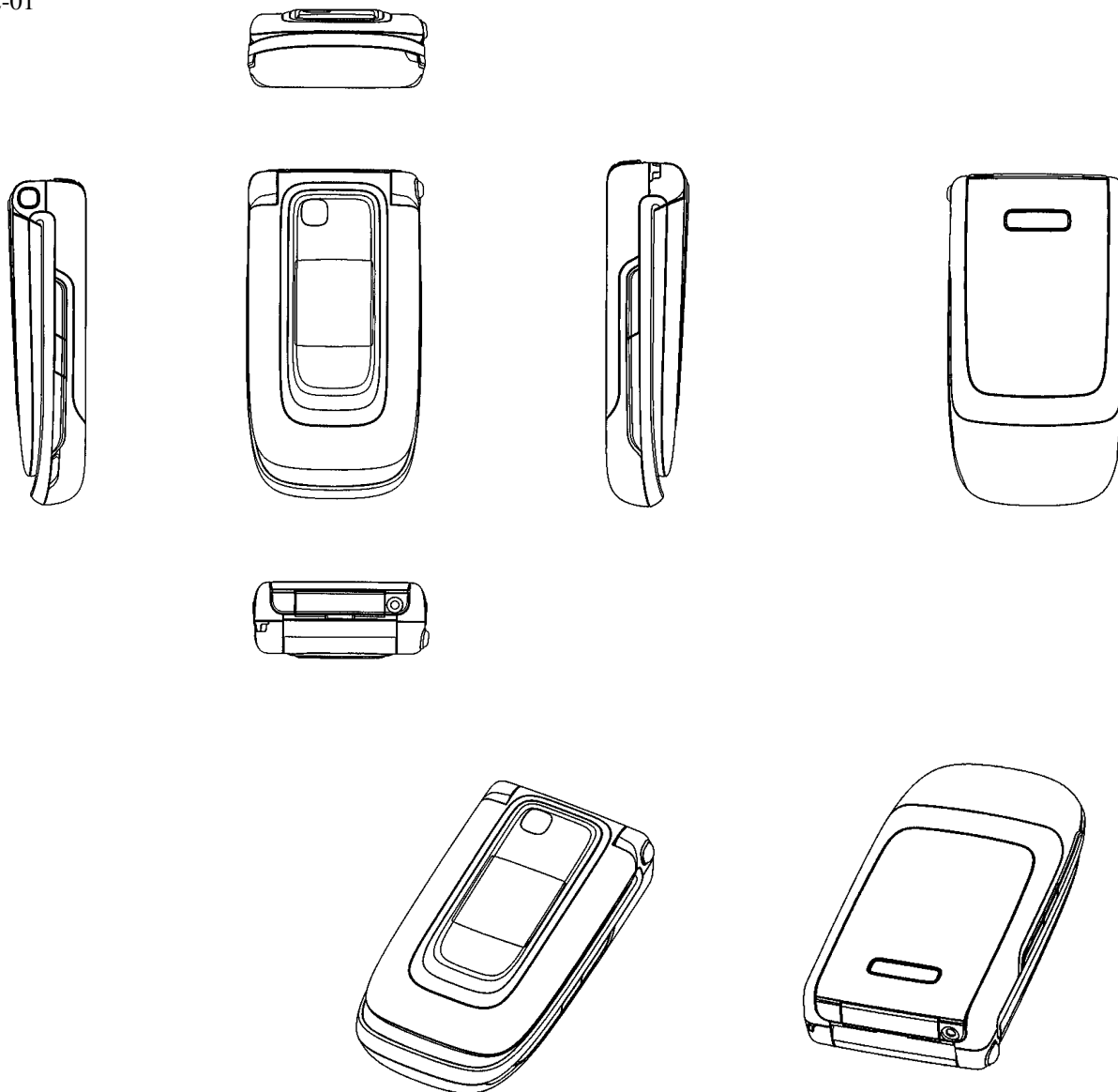

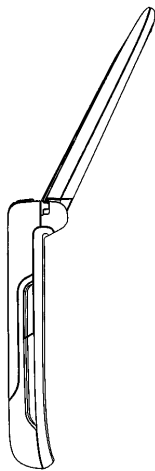
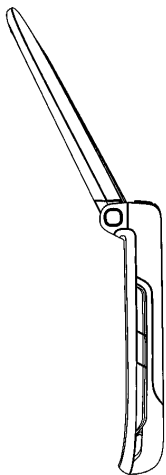
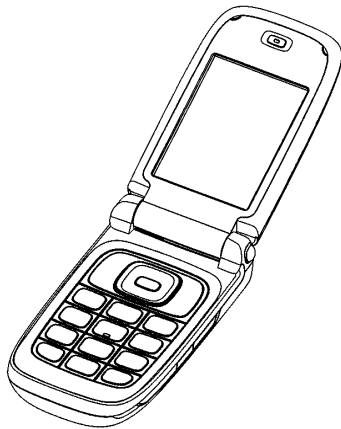
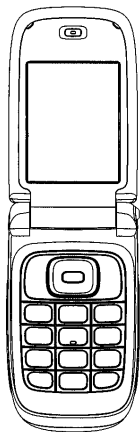

(11) **Registreeringu number** **01183**

(51) Klass: **14-03**

(21) **Taotluse number** D200600045

(15) **Registreerimise päev** 15.11.2006

(22) **Esitamise päev** 30.06.2006

(24) **Registreeringu kehtivuse alguse päev** 30.06.2006

(18) **Registreeringu kehtivuse lõppemise päev** 30.06.2011

(28) **Variantide arv** 1

(30) **Prioriteediandmed** M20060007, 05.01.2006, FI

(72) **Autor** Pertti Salmi, Sirppitie 30, 90530 Oulu, FI

(73) **Omanik** Nokia Corporation, Keilalahdentie 4, FIN-02150 Espoo, FI

(74) **Patendivolinik või ühine esindaja** Kaie Puur

(54) **Nimetus** **Käsitelefon**

(55) **Reproduksioon**

01183-01

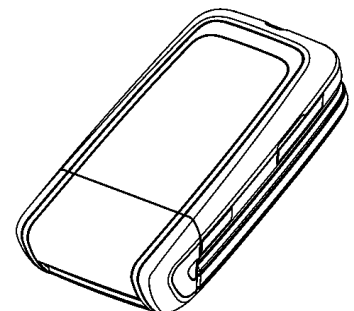
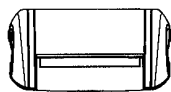
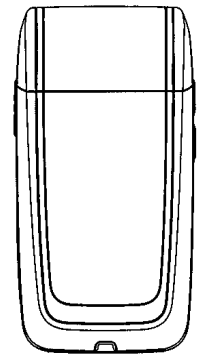
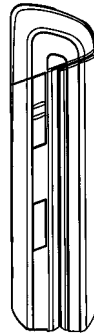
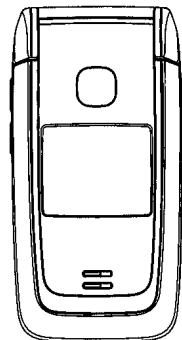
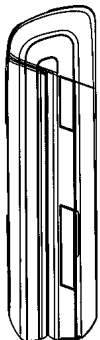
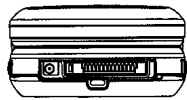

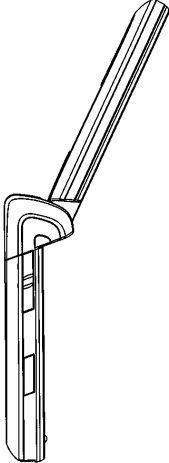
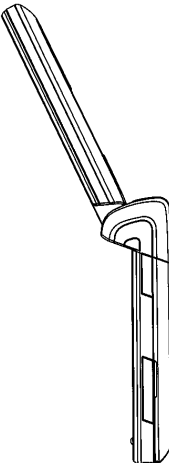
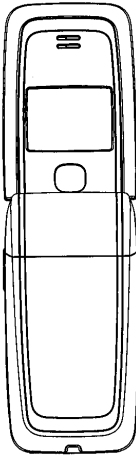
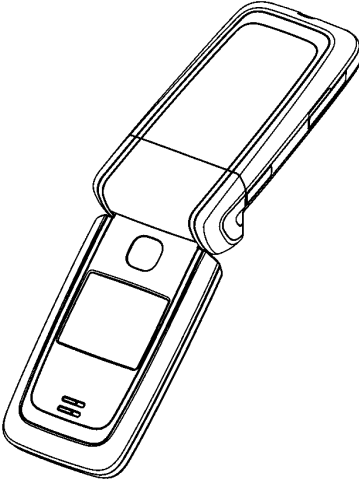
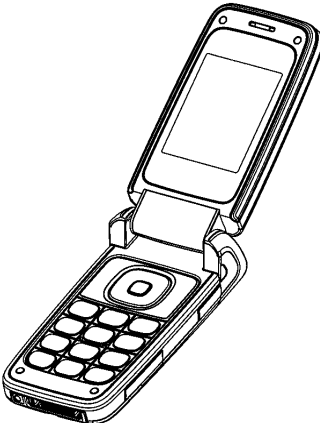
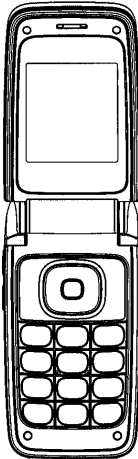

(11) **Registreeringu number** **01184**

(51) Klass: **14-03**

(21) **Taotluse number** D200600046

(15) **Registreerimise päev** 15.11.2006

(22) **Esitamise päev** 30.06.2006

(24) **Registreeringu kehtivuse
alguse päev** 30.06.2006

(18) **Registreeringu kehtivuse
lõppemise päev** 30.06.2011

(28) **Variantide arv** 1

(30) **Prioriteediandmed** M20060006, 05.01.2006, FI

(72) **Autor** Anton Fahlgren, Nordre Frihavnsgade 28, 2100 Copenhagen, DK
Alexandra Tyrer, Godthåbsvej 12A 3TV, 2000 Frederiksberg, DK

(73) **Omanik** Nokia Corporation, Keilalahdentie 4, FIN-02150 Espoo, FI

(74) **Patendivolinik või ühine esindaja** Kalev Käosaar

(54) **Nimetus** **Käsitelefon**

(55) **Reproduksioon**

01184-01

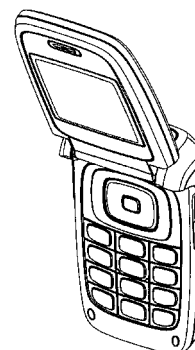
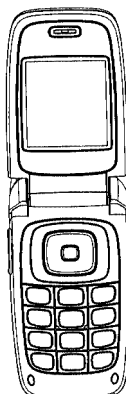
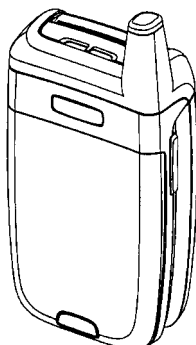
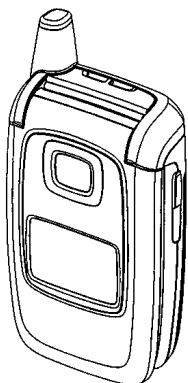
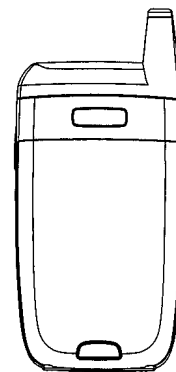
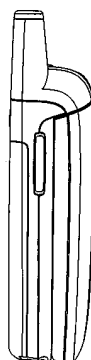
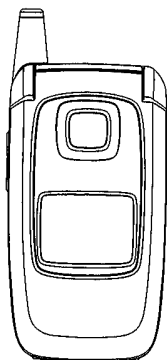
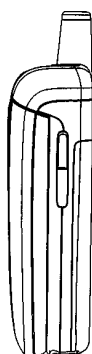
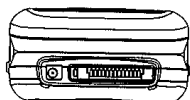

(11) **Registreeringu number** **01185**

(51) Klass: **14-03**

(21) **Taotluse number** D200600047

(15) **Registreerimise päev** 15.11.2006

(22) **Esitamise päev** 30.06.2006

(24) **Registreeringu kehtivuse alguse päev** 30.06.2006

(18) **Registreeringu kehtivuse lõppemise päev** 30.06.2011

(28) **Variantide arv** 1

(30) **Prioriteediandmed** M20060026, 03.02.2006, FI

(72) **Autor** Shunjiro Eguchi, Otavantie 3 A 25, 00200 Helsinki, FI

(73) **Omanik** Nokia Corporation, Keilalahdentie 4, FIN-02150 Espoo, FI

(74) **Patendivolinik või ühine esindaja** Kaie Puur

(54) **Nimetus** **Käsitelefon**

(55) **Reproduktsoon**

01185-01

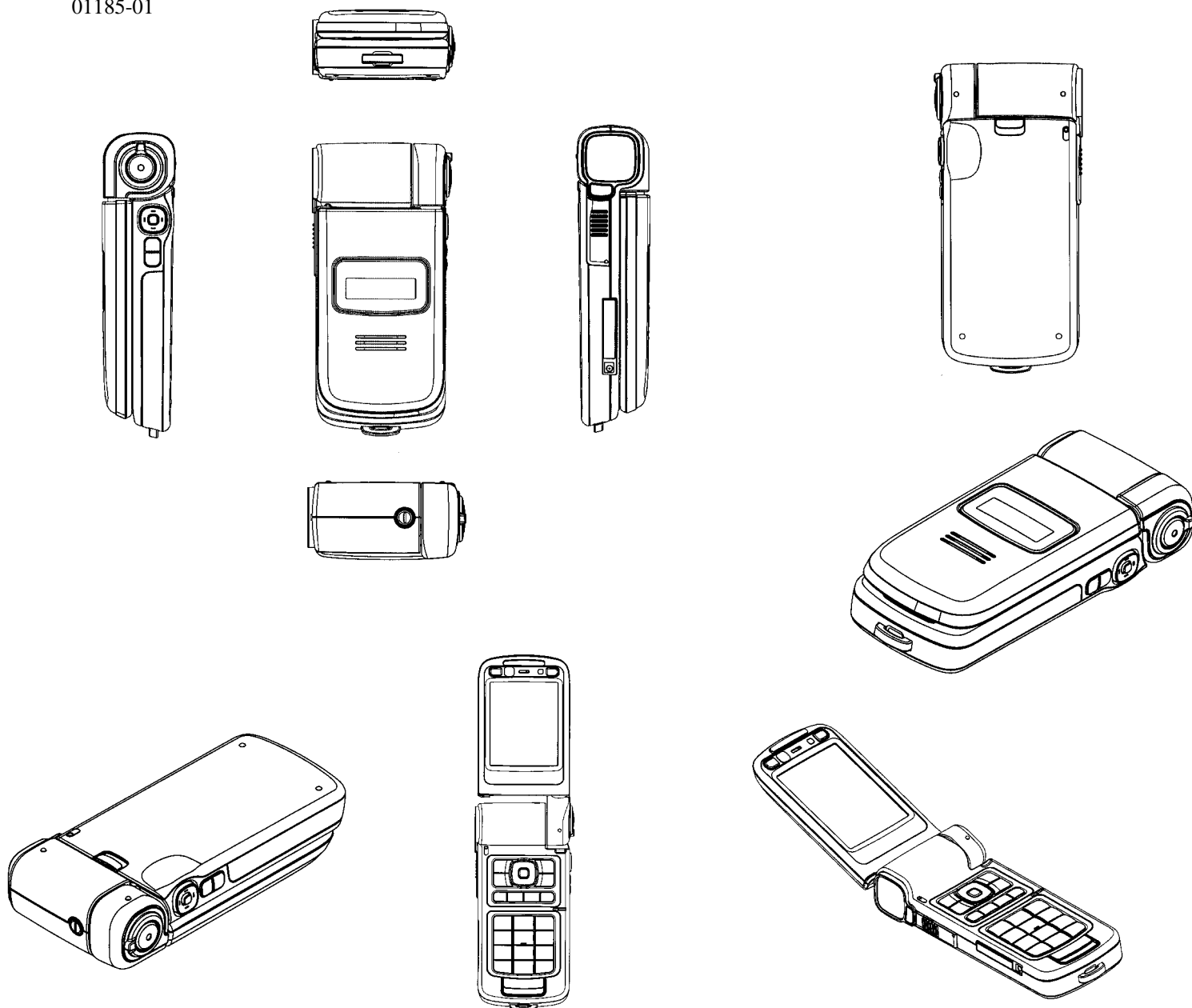

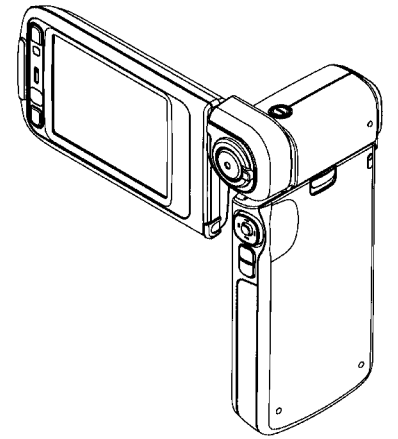
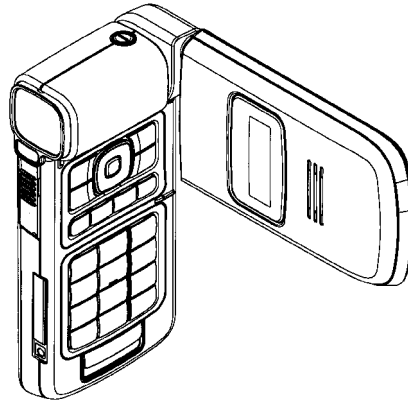
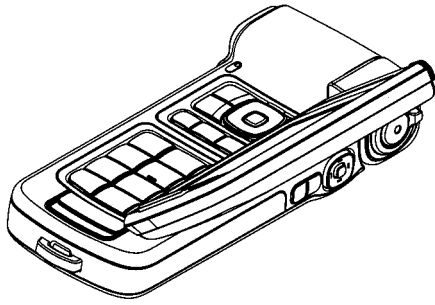
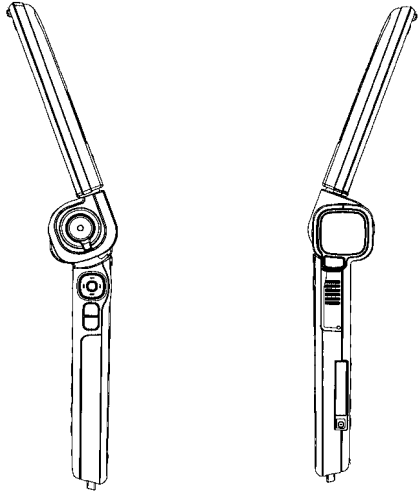

(11) Registreeringu number	01186	(51) Klass: 08-06
(21) Taotluse number	D200600048	
(15) Registreerimise päev	15.11.2006	
(22) Esitamise päev	06.07.2006	
(24) Registreeringu kehtivuse alguse päev	06.07.2006	
(18) Registreeringu kehtivuse lõppemise päev	06.07.2011	
(28) Variantide arv	2	
(30) Prioriteediandmed	M-20060071, 31.03.2006, FI	
(72) Autor	Arto Mäkelä, Akselintanhua 2-4B, FI-33470 Ylöjärvi, FI	
(73) Omanik	Abloy Oy, Wahlforssinkatu 20, FI-80100 Joensuu, FI	
(74) Patendivolinik või ühine esindaja	Lembit Mitt	

(54) Nimetus **Pöördnupp**

(55) Reproduksioon

01186-01

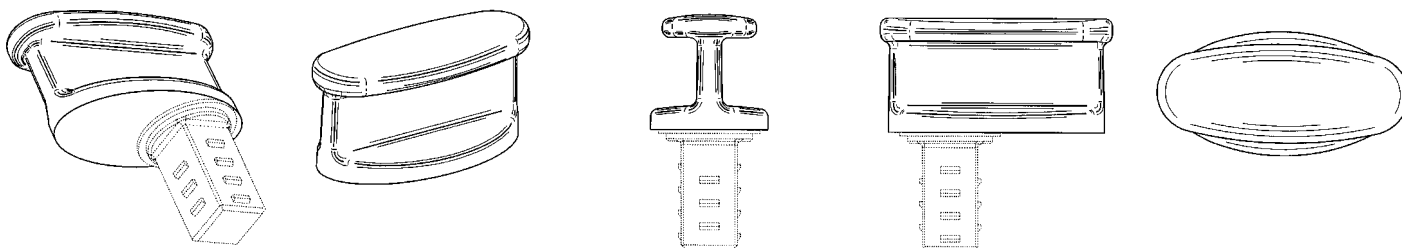

01186-02

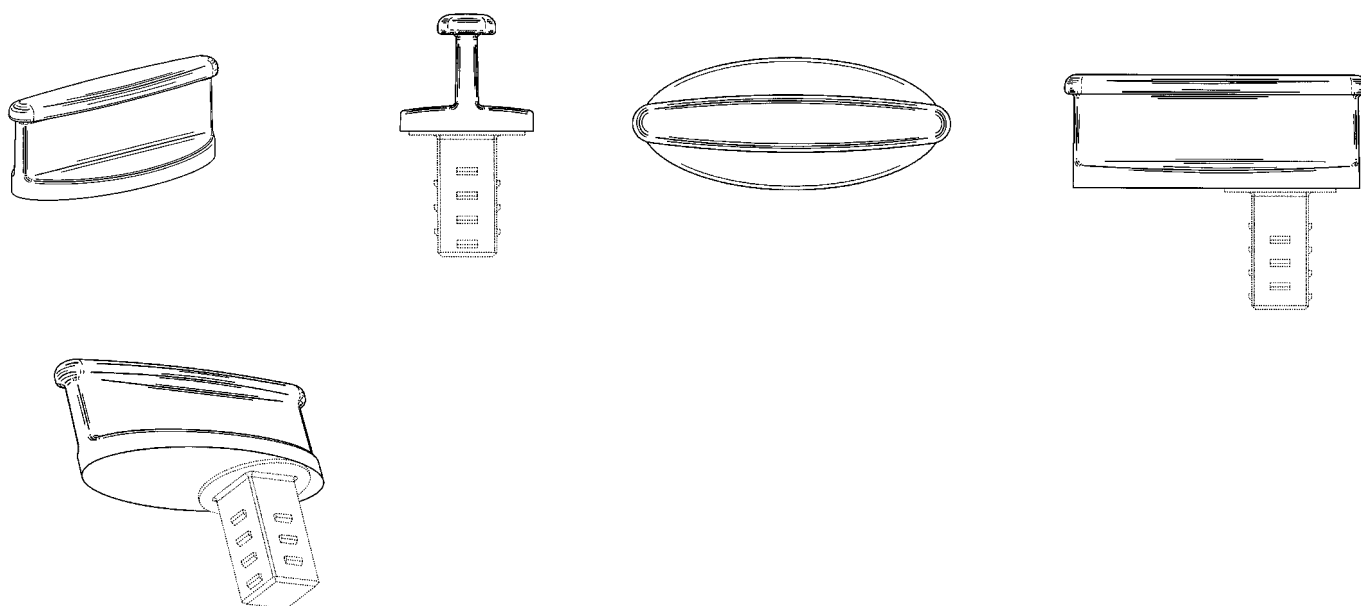

(11) **Registreeringu number** **01187**

(51) Klass: **08-06, 08-09**

(21) **Taotluse number** D200600049

(15) **Registreerimise päev** 15.11.2006

(22) **Esitamise päev** 06.07.2006

(24) **Registreeringu kehtivuse alguse päev** 06.07.2006

(18) **Registreeringu kehtivuse lõppemise päev** 06.07.2011

(28) **Variantide arv** 1

(30) **Prioriteediandmed** M-20060084, 12.04.2006, FI

(72) **Autor** Arto Mäkelä, Akselintanhua 2-4B, FI-33470 Ylöjärvi, FI

(73) **Omanik** Abloy Oy, Wahlforssinkatu 20, FI-80100 Joensuu, FI

(74) **Patendivolinik või ühine esindaja** Lembit Mitt

(54) **Nimetus** **Käepide**

(55) **Reproduktsoon**

01187-01

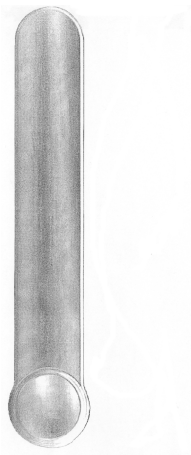
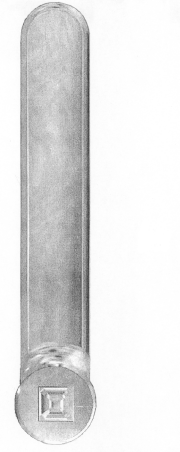
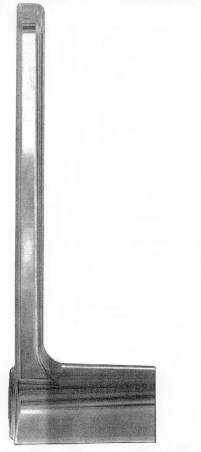

(11) Registreeringu number	01188	(51) Klass: 09-01
(21) Taotluse number	D200600050	
(15) Registreerimise päev	15.11.2006	
(22) Esitamise päev	11.07.2006	
(24) Registreeringu kehtivuse alguse päev	11.07.2006	
(18) Registreeringu kehtivuse lõppemise päev	11.07.2011	
(28) Variantide arv	1	
(72) Autor	<i>Autori andmeid ei avalikustata</i>	
(73) Omanik	Saku Õlletehase AS, Saku, 75501 Harju maakond, EE	
(74) Patendivolinik või ühine esindaja	Ott Moorlat	

(54) Nimetus **Pudel**

(55) Reproduktsoon

01188-01

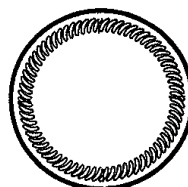

(11) Registreeringu number	01189
(21) Taotluse number	D200600051
(15) Registreerimise päev	15.11.2006
(22) Esitamise päev	12.07.2006
(24) Registreeringu kehtivuse alguse päev	12.07.2006
(18) Registreeringu kehtivuse lõppemise päev	12.07.2011
(28) Variantide arv	2
(72) Autor	Mati Alvela, Vilja 18b-52, 65606 Võru, EE
(73) Omanik	Mati Alvela, Vilja 18b-52, 65606 Võru, EE

(51) Klass: **07-06**(54) Nimetus **Pudelihoidja**

(55) Reproduktsioon

01189-01



01189-02

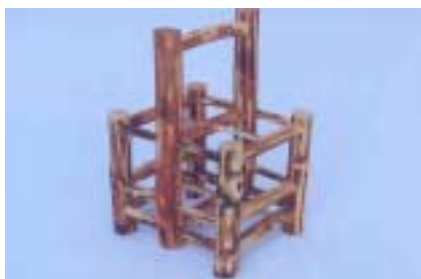

(11) Registreeringu number	01190	(51) Klass: 21-04
(21) Taotluse number	D200600052	
(15) Registreerimise päev	15.11.2006	
(22) Esitamise päev	26.07.2006	
(24) Registreeringu kehtivuse alguse päev	26.07.2006	
(18) Registreeringu kehtivuse lõppemise päev	26.07.2011	
(28) Variantide arv	1	
(72) Autor	Juri Vassiljev, Tallinna mnt 33-102, 20303 Narva, EE	
(73) Omanik	Juri Vassiljev, Tallinna mnt 33-102, 20303 Narva, EE	
(74) Patendivolinik või ühine esindaja	Reet Maasikamäe	

(54) Nimetus **Kokkupandav varitelk**

(55) Reproduktsoon

01190-01



(11) Registreeringu number	01191	(51) Klass: 21-04
(21) Taotluse number	D200600053	
(15) Registreerimise päev	15.11.2006	
(22) Esitamise päev	26.07.2006	
(24) Registreeringu kehtivuse alguse päev	26.07.2006	
(18) Registreeringu kehtivuse lõppemise päev	26.07.2011	
(28) Variantide arv	1	
(72) Autor	Juri Vassiljev, Tallinna mnt 33-102, 20303 Narva, EE	
(73) Omanik	Juri Vassiljev, Tallinna mnt 33-102, 20303 Narva, EE	
(74) Patendivolinik või ühine esindaja	Reet Maasikamäe	

(54) Nimetus **Kokkupandava varitelgi karkass**

(55) Reproduktsoon

01191-01

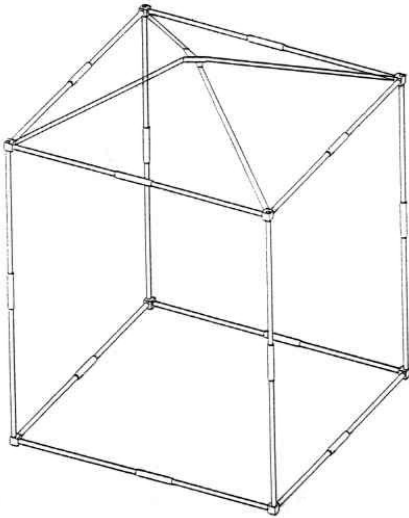

- (11) **Registreeringu number** **01192** (51) Klass: **25-03**
- (21) **Taotluse number** D200600056
- (15) **Registreerimise päev** 15.11.2006
- (22) **Esitamise päev** 26.07.2006
- (24) **Registreeringu kehtivuse alguse päev** 26.07.2006
- (18) **Registreeringu kehtivuse lõppemise päev** 26.07.2011
- (28) **Variantide arv** 2
- (72) **Autor** Aigar Pindmaa, Simula, Haanja vald, 65101 Võru maakond, EE
- (73) **Omanik** Aigar Pindmaa, Simula, Haanja vald, 65101 Võru maakond, EE
Mae Pindmaa, Simula, Haanja vald, 65101 Võru maakond, EE
- (74) **Patendivolinik või ühine esindaja** Ott Moorlat

(54) **Nimetus** **Savihotell**

(55) **Reproduktsoon**

01192-01

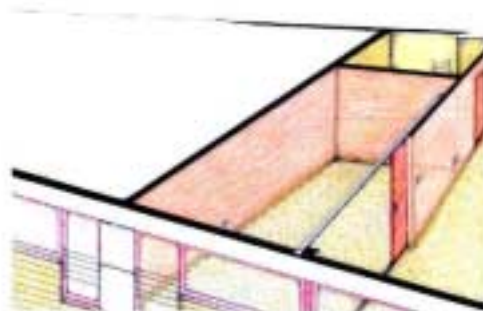

01192-02

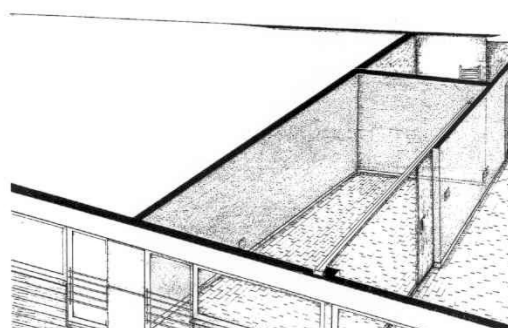
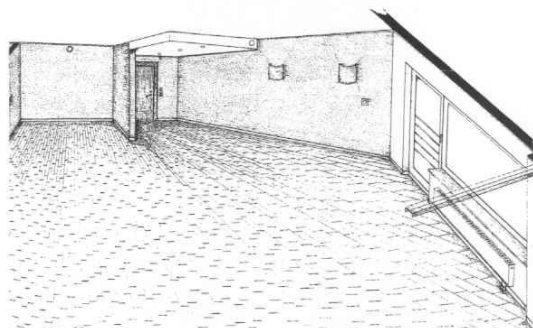

(11) Registreeringu number	01193	(51) Klass: 25-03
(21) Taotluse number	D200600057	
(15) Registreerimise päev	15.11.2006	
(22) Esitamise päev	26.07.2006	
(24) Registreeringu kehtivuse alguse päev	26.07.2006	
(18) Registreeringu kehtivuse lõppemise päev	26.07.2011	
(28) Variantide arv	2	
(72) Autor	Aigar Pindmaa, Simula, Haanja vald, 65101 Võru maakond, EE	
(73) Omanik	Aigar Pindmaa, Simula, Haanja vald, 65101 Võru maakond, EE Mae Pindmaa, Simula, Haanja vald, 65101 Võru maakond, EE	
(74) Patendivolinik või ühine esindaja	Ott Moorlat	

(54) Nimetus **Savivannituba**

(55) Reproduktsoon

01193-01

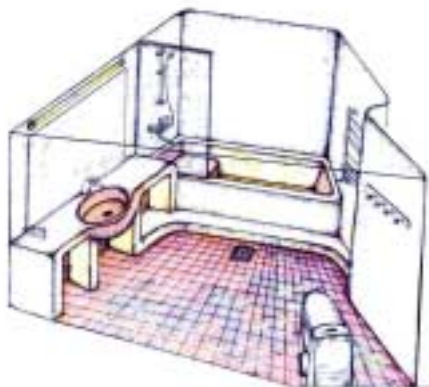

01193-02

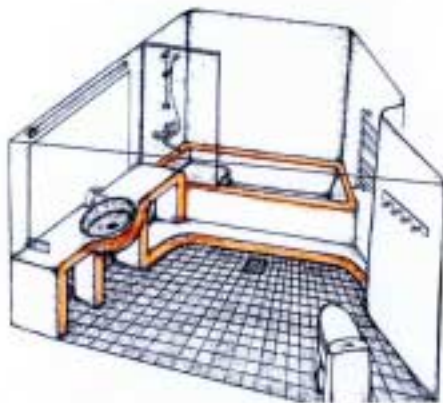

- (11) **Registreeringu number** **01194** (51) Klass: **25-03**
- (21) **Taotluse number** D200600058
- (15) **Registreerimise päev** 15.11.2006
- (22) **Esitamise päev** 26.07.2006
- (24) **Registreeringu kehtivuse alguse päev** 26.07.2006
- (18) **Registreeringu kehtivuse lõppemise päev** 26.07.2011
- (28) **Variantide arv** 1
- (72) **Autor** Aigar Pindmaa, Simula, Haanja vald, 65101 Võru maakond, EE
- (73) **Omanik** Aigar Pindmaa, Simula, Haanja vald, 65101 Võru maakond, EE
Mae Pindmaa, Simula, Haanja vald, 65101 Võru maakond, EE
- (74) **Patendivolinik või ühine esindaja** Ott Moorlat

(54) **Nimetus** **Savivannituba**

(55) **Reproduktsoon**

01194-01

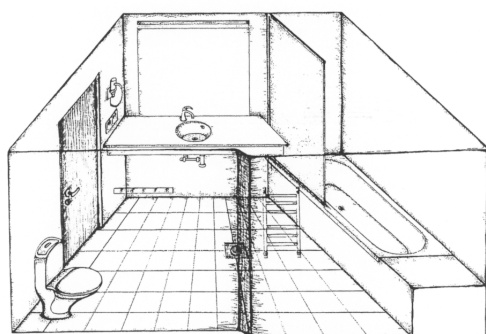

(11) Registreeringu number	01195	(51) Klass: 21-01
(21) Taotluse number	D200600059	
(15) Registreerimise päev	15.11.2006	
(22) Esitamise päev	27.07.2006	
(24) Registreeringu kehtivuse alguse päev	27.07.2006	
(18) Registreeringu kehtivuse lõppemise päev	27.07.2011	
(28) Variantide arv	1	
(72) Autor	Indrek Schwede, Männi 2, Sillaotsa, Jõelähtme vald, 74202 Harju maakond, EE	
(73) Omanik	Indrek Schwede, Männi 2, Sillaotsa, Jõelähtme vald, 74202 Harju maakond, EE	
(74) Patendivolinik või ühine esindaja	Ott Moorlat	

(54) Nimetus Lauamäng "Täringujalgpall"

(55) Reproduktsoon

01195-01



- (11) **Registreeringu number** **01196**
- (21) **Taotluse number** D200600060
- (15) **Registreerimise päev** 15.11.2006
- (22) **Esitamise päev** 02.08.2006
- (24) **Registreeringu kehtivuse alguse päev** 02.08.2006
- (18) **Registreeringu kehtivuse lõppemise päev** 02.08.2011
- (28) **Variantide arv** 1
- (72) **Autor** Arvo Suppi, Mai 34-150, 80045 Pärnu, EE
- (73) **Omanik** AS REIDENI PLAAT, Paide mnt. 1, 80042 Pärnu, EE
- (74) **Patendivolinik või ühine esindaja** Lembit Kalev

(51) Klass: **25-01, 25-02**

(54) **Nimetus** **Ehitusplokk**

(55) **Reproduksioon**

01196-01



(11) Registreeringu number	01197	(51) Klass: 21-04
(21) Taotluse number	D200600061	
(15) Registreerimise päev	15.11.2006	
(22) Esitamise päev	16.08.2006	
(24) Registreeringu kehtivuse alguse päev	16.08.2006	
(18) Registreeringu kehtivuse lõppemise päev	16.08.2011	
(28) Variantide arv	1	
(72) Autor	Juri Vassiljev, Tallinna mnt 33-102, 20303 Narva, EE	
(73) Omanik	Juri Vassiljev, Tallinna mnt 33-102, 20303 Narva, EE	
(74) Patendivolinik või ühine esindaja	Reet Maasikamäe	

(54) Nimetus **Kokkupandava varitelgi karkass**

(55) Reproduktsoon

01197-01

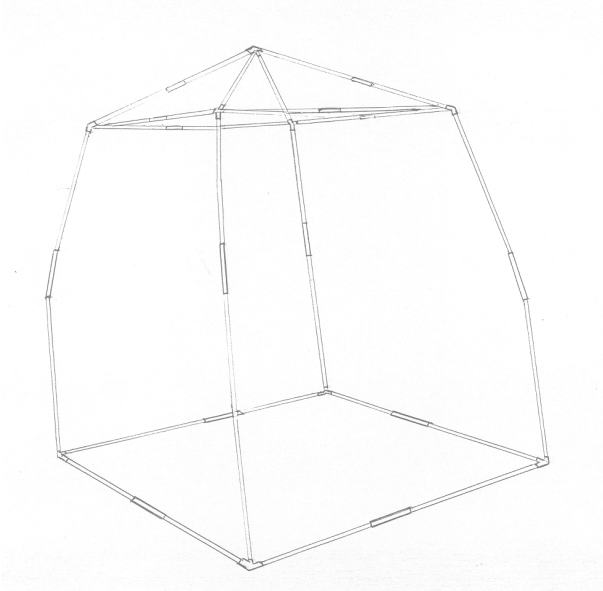

(11) Registreeringu number	01198	(51) Klass: 14-03
(21) Taotluse number	D200600067	
(15) Registreerimise päev	15.11.2006	
(22) Esitamise päev	23.08.2006	
(24) Registreeringu kehtivuse alguse päev	23.08.2006	
(18) Registreeringu kehtivuse lõppemise päev	23.08.2011	
(28) Variantide arv	1	
(30) Prioriteediandmed	M20060043, 24.02.2006, FI	
(72) Autor	Luke Miles, 32 Hillcrest Road, Acton, London W39RY, GB Anthony Dalby, 30, Chandos Avenue, Ealing, London W5 4ER, GB	
(73) Omanik	Nokia Corporation, Keilalahdentie 4, FIN-02150 Espoo, FI	
(74) Patendivolinik või ühine esindaja	Kalev Käosaar	

(54) Nimetus **Käsitelefoni esipaneel**

(55) Reproduktsoon

01198-01

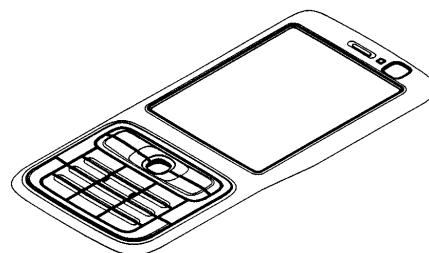
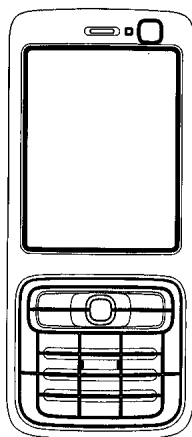

(11) **Registreeringu number** **01199**

(51) Klass: **14-03**

(21) **Taotluse number** D200600068

(15) **Registreerimise päev** 15.11.2006

(22) **Esitamise päev** 23.08.2006

(24) **Registreeringu kehtivuse
alguse päev** 23.08.2006

(18) **Registreeringu kehtivuse
lõppemise päev** 23.08.2011

(28) **Variantide arv** 1

(30) **Prioriteediandmed** M20060043, 24.02.2006, FI

(72) **Autor** Luke Miles, 32 Hillcrest Road, Acton, London W39RY, GB
Anthony Dalby, 30, Chandos Avenue, Ealing, London W5 4ER, GB

(73) **Omanik** Nokia Corporation, Keilalahdentie 4, FIN-02150 Espoo, FI

(74) **Patendivolinik või ühine esindaja** Kalev Käosaar

(54) **Nimetus** **Käsitelefon**

(55) **Reproduksioon**

01199-01

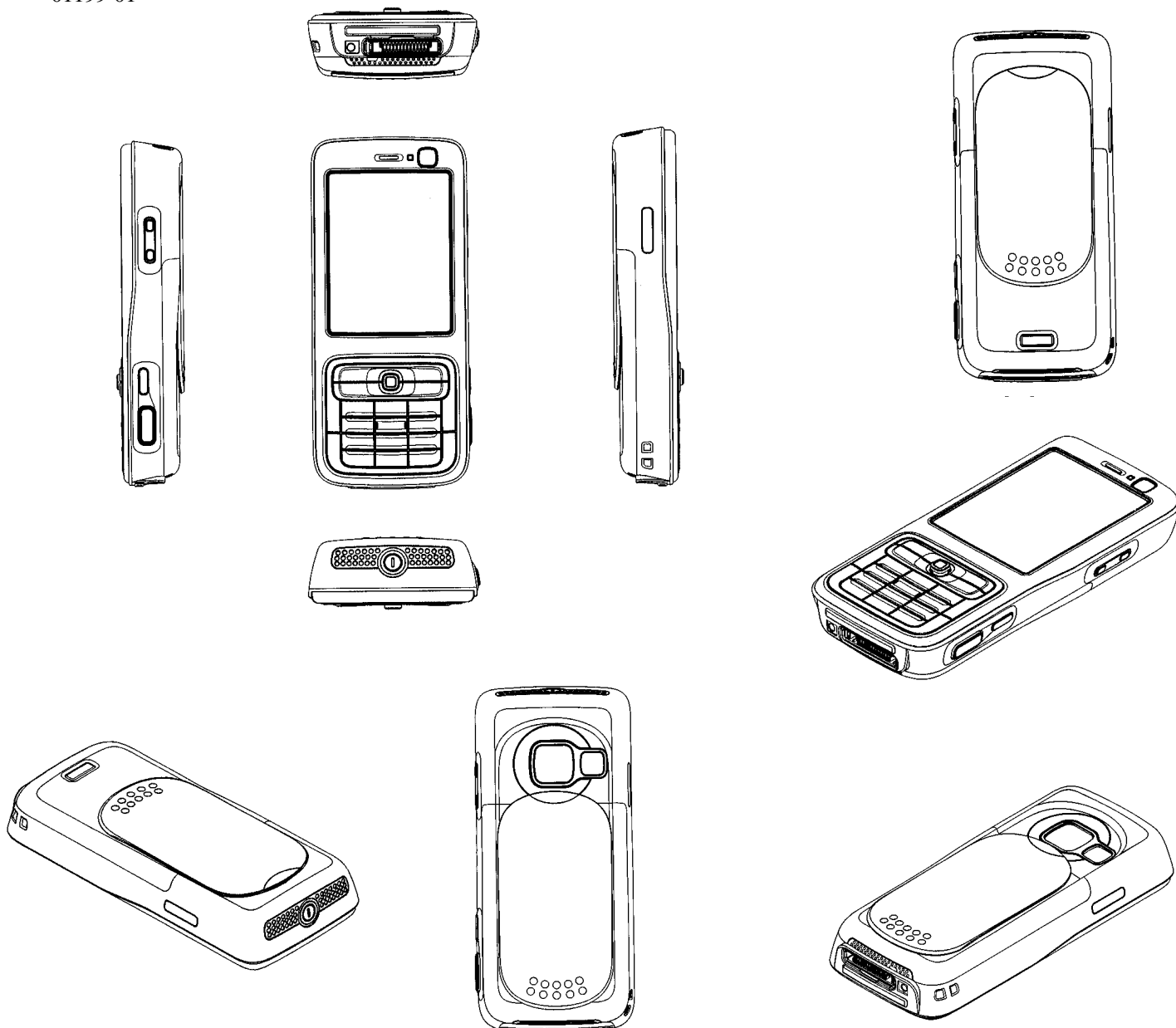

(11) **Registreeringu number** **01200**

(51) **Klass:** **12-06**

(21) **Taotluse number** D200600069

(15) **Registreerimise päev** 15.11.2006

(22) **Esitamise päev** 25.08.2006

(24) **Registreeringu kehtivuse
alguse päev** 25.08.2006

(18) **Registreeringu kehtivuse
lõppemise päev** 25.08.2011

(28) **Variantide arv** 1

(72) **Autor** Ridas Kaleininkas, Koru põik 1A, Saue vald, 76402 Harju maakond, EE

(73) **Omanik** Ridas Kaleininkas, Koru põik 1A, Saue vald, 76402 Harju maakond, EE

(74) **Patendivolinik või ühine esindaja** Jaak Ostrat

(54) **Nimetus** **Jahi korpus**

(55) **Reproduktsoon**

01200-01

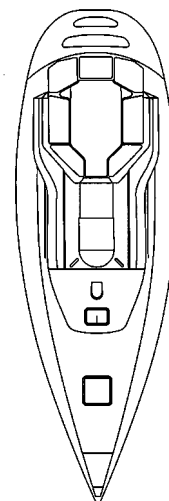
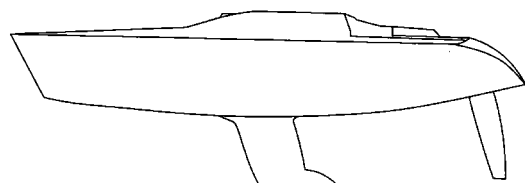

II. RAHVUSVAHELISELT REGISTREERITUD TÖÖSTUSDISAINILAHENDUSED

Avaldatakse "Tööstusdisaini kaitse seaduse" § 87⁴ lõike37 alusel.

(11) Rahvusvah reg nr	DM/066825	(51) Klass: 10-07
(21) Rahvusvah reg jrk	H200500163	
(15) Registreeringu päev	15.06.2005	
(22) Esitamise päev	15.06.2005	
(28) Variantide arv	4	
(72) Autor	Xavier Perrenoud, XJC Sàrl, Rue du Plan 3, CH-2000 Neuchâtel, CH	
(73) Omanik	MGI LUXURY GROUP SA, Nidaugasse 35, CH-2502 Bienne, CH	
WIPO Rahvusvah Tööstusdisainilahenduste Bülettääni nr, kus registreering on avaldatud	2005/11	

(54) **Nimetus** 1.-4. Watch cases

(55) **Reproduktsoon**

DM/066825-01



DM/066825-02



DM/066825-03



DM/066825-04



(11) Rahvusvah reg nr	DM/066825	(51) Klass: 10-07
(21) Rahvusvah reg jrk	H200500163A	
(15) Registreeringu päev	15.06.2005	
(22) Esitamise päev	15.06.2005	
(28) Variantide arv	3	
(72) Autor	Jean-Pierre Chodat, Grand Rue 14, CH-2012 Auvernier, CH	
(73) Omanik	MGI LUXURY GROUP SA, Nidaugasse 35, CH-2502 Bienne, CH	
WIPO Rahvusvah Tööstusdisainilahenduste Bülletääni nr, kus registreering on avaldatud	2005/11	

(54) **Nimetus** **1.-3. Watch cases**

(55) **Reproduktsoon**

DM/066825-01



DM/066825-02



DM/066825-03



(11) Rahvusvah reg nr	DM/066825	(51) Klass: 10-07
(21) Rahvusvah reg jrk	H200500163B	
(15) Registreeringu päev	15.06.2005	
(22) Esitamise päev	15.06.2005	
(28) Variantide arv	1	
(72) Autor	Marco Scarinzi, Rue J. Stämpfli 4, CH-2502 Bienne, CH	
(73) Omanik	MGI LUXURY GROUP SA, Nidaugasse 35, CH-2502 Bienne, CH	
WIPO Rahvusvah Tööstusdisainilahenduste Bülletääni nr, kus registreering on avaldatud	2005/11	

(54) **Nimetus** **Watch bracelet**

(55) **Reproduktsoon**

DM/066825-01



(11) Rahvusvah reg nr	DM/066906	(51) Klass: 10-02, 10-07
(21) Rahvusvah reg jrk	H200600019	
(15) Registreeringu päev	12.08.2005	
(22) Esitamise päev	12.08.2005	
(28) Variantide arv	3	
(30) Prioriteediandmed	131 652, 22.03.2005, CH	
(72) Autor	Maria Cristina CALVANI, Chemin David Munier 12, CH-1223 Cologny, CH	
(73) Omanik	ROLEX SA, Rue Francois-Dussaud 3-5-7, CH-1211 Genève 26, CH	
WIPO Rahvusvah Tööstusdisainilahenduste		
Bülletääni nr, kus registreering on avaldatud	2006/01	

(54) **Nimetus** **Watch; Watch case; Watch dial**

(55) **Reproduksioon**

DM/066906-01

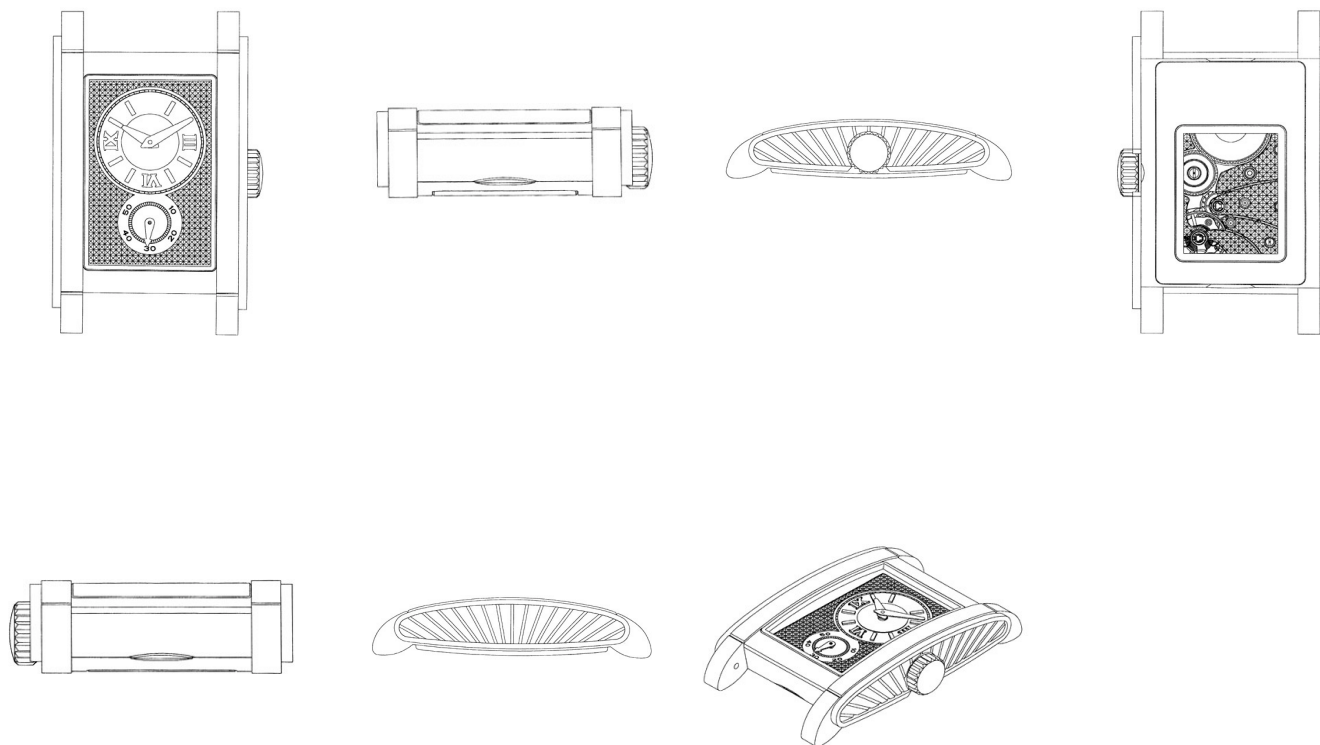

DM/066906-02

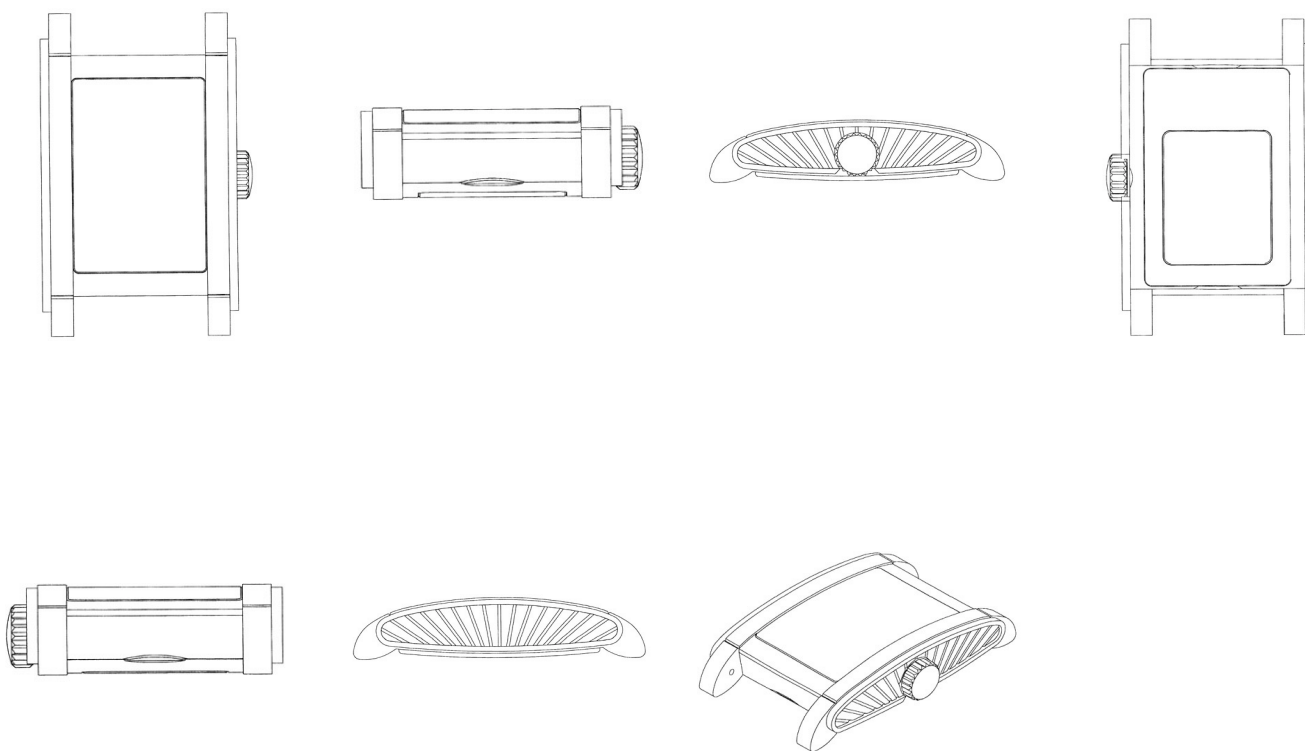

DM/066906-03

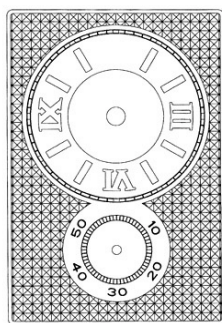

(11) Rahvusvah reg nr	DM/066906	(51) Klass: 10-02, 10-07
(21) Rahvusvah reg jrk	H200600019A	
(15) Registreeringu päev	12.08.2005	
(22) Esitamise päev	12.08.2005	
(28) Variantide arv	3	
(30) Prioriteediandmed	131 652, 22.03.2005, CH	
(72) Autor	Maria Cristina CALVANI, Chemin David Munier 12, CH-1223 Cologny, CH	
(73) Omanik	ROLEX SA, Rue Francois-Dussaud 3-5-7, CH-1211 Genève 26, CH	
WIPO Rahvusvah Tööstusdisainilahenduste		
Bülletääni nr, kus registreering on avaldatud	2006/01	

(54) **Nimetus** **Watch; Watch case; Watch dial**

(55) **Reproduksioon**

DM/066906-01

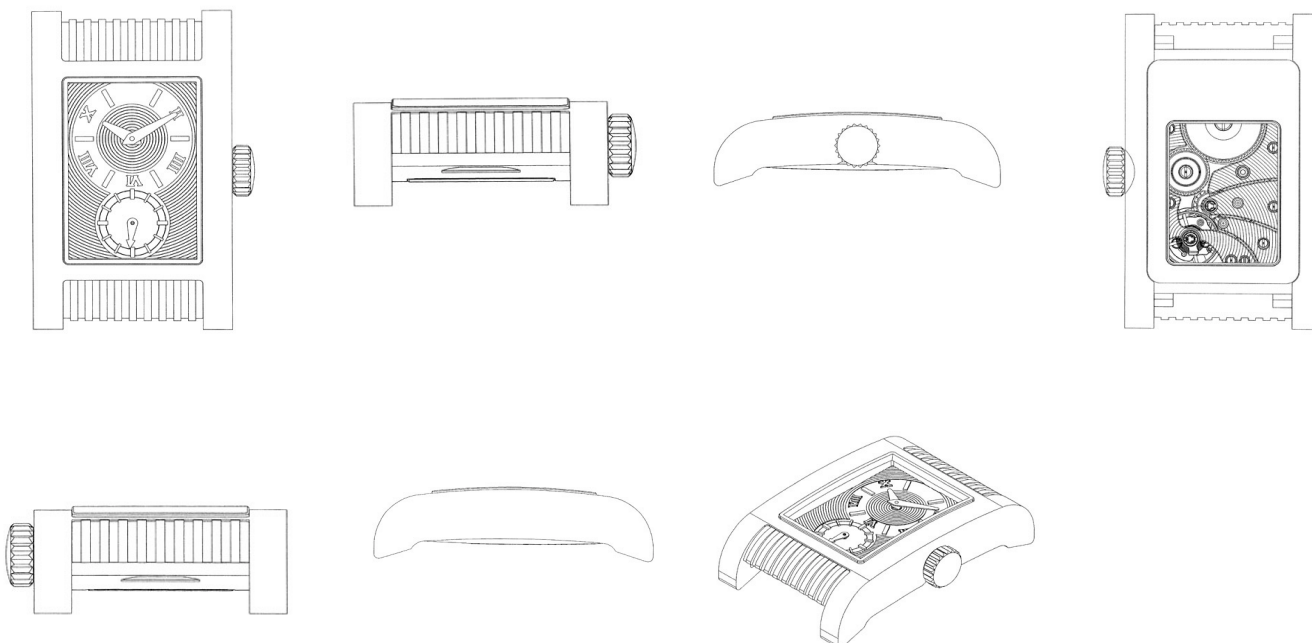

DM/066906-02

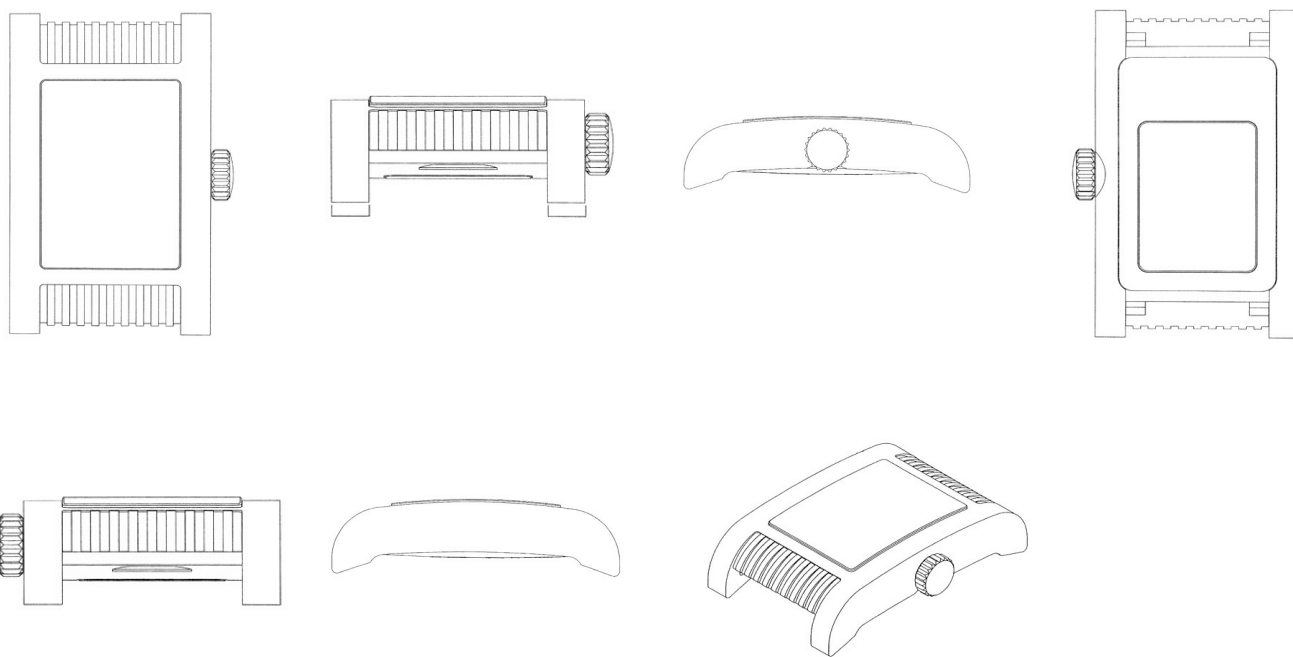

DM/066906-03

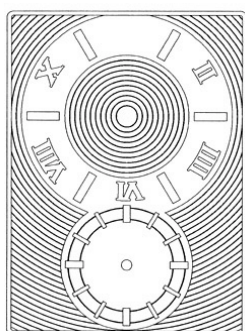

(11) Rahvusvah reg nr	DM/066906	(51) Klass: 10-02, 10-07
(21) Rahvusvah reg jrk	H200600019B	
(15) Registreeringu päev	12.08.2005	
(22) Esitamise päev	12.08.2005	
(28) Variantide arv	3	
(30) Prioriteediandmed	131 652, 22.03.2005, CH	
(72) Autor	Maria Cristina CALVANI, Chemin David Munier 12, CH-1223 Cologny, CH	
(73) Omanik	ROLEX SA, Rue Francois-Dussaud 3-5-7, CH-1211 Genève 26, CH	
WIPO Rahvusvah Tööstusdisainilahenduste		
Bülletääni nr, kus registreering on avaldatud	2006/01	

(54) **Nimetus** **Watch; Watch case; Watch dial**

(55) **Reproduksioon**

DM/066906-01

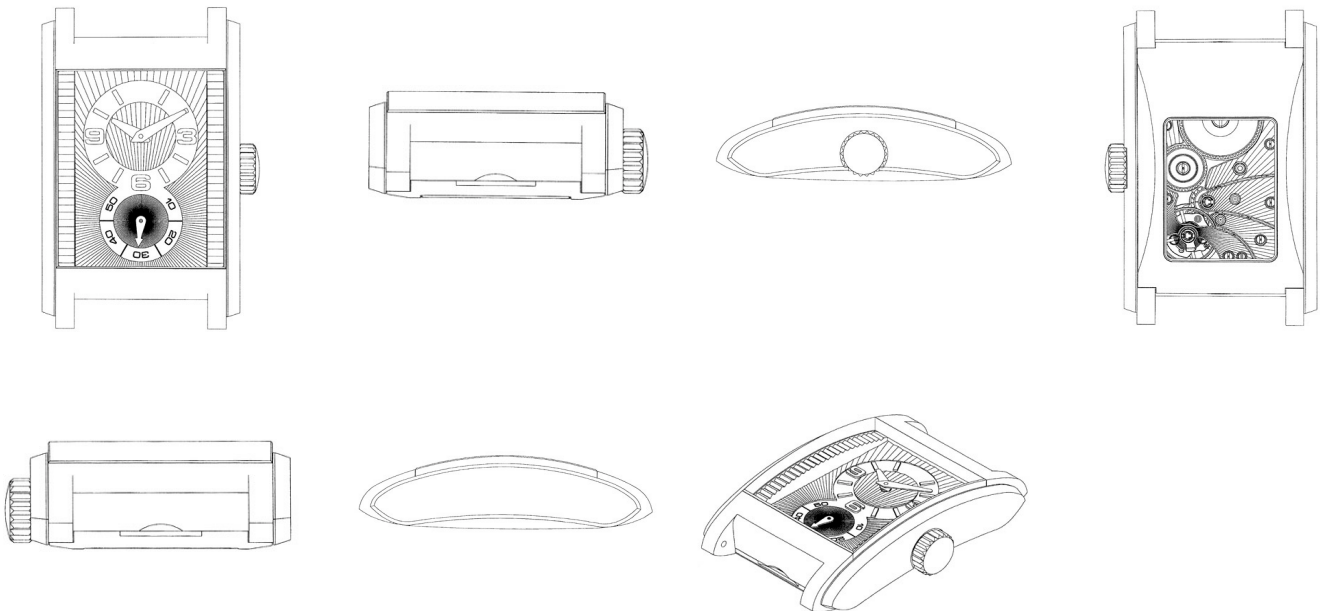

DM/066906-02

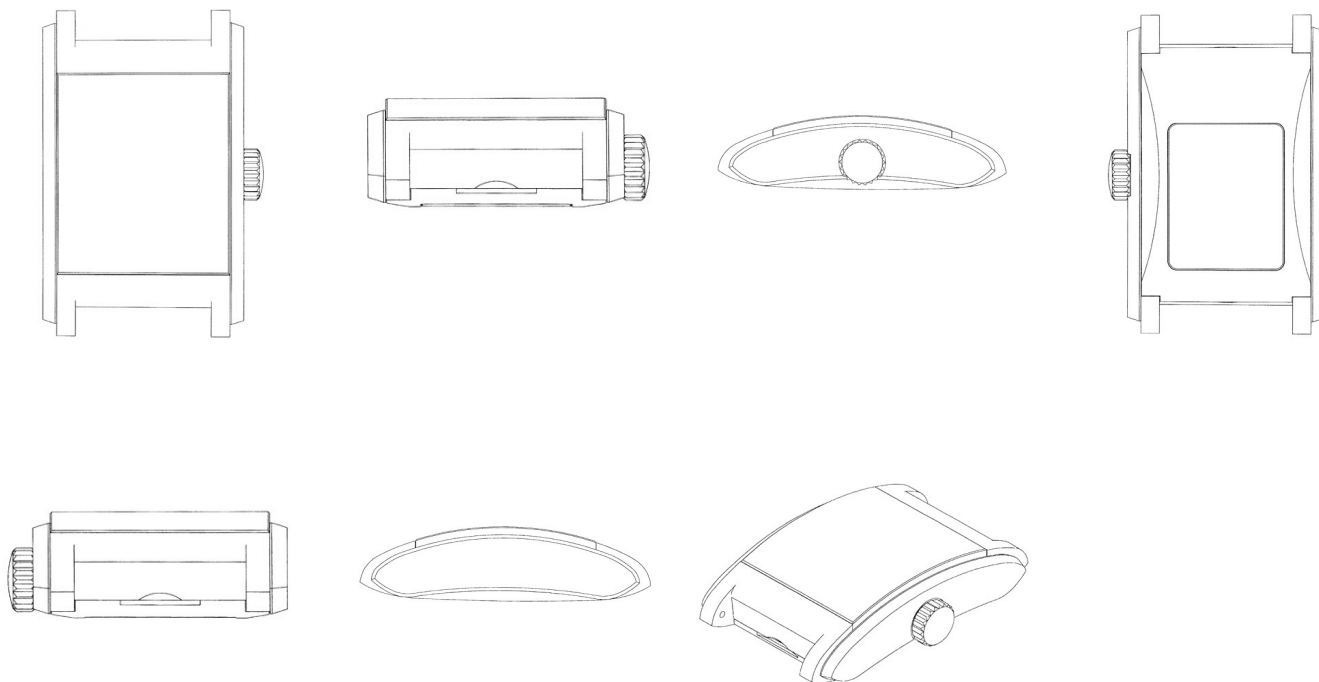

DM/066906-03

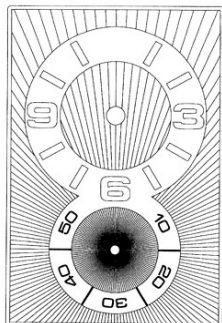

- (11) **Rahvusvah reg nr** DM/066906 (51) Klass: 10-02, 10-07
- (21) **Rahvusvah reg jrk** H200600019C
- (15) **Registreeringu päev** 12.08.2005
- (22) **Esitamise päev** 12.08.2005
- (28) **Variantide arv** 3
- (30) **Prioriteediandmed** 131 652, 22.03.2005, CH
- (72) **Autor** Maria Cristina CALVANI, Chemin David Munier 12, CH-1223 Cologny, CH
- (73) **Omanik** ROLEX SA, Rue Francois-Dussaud 3-5-7, CH-1211 Genève 26, CH
- WIPO Rahvusvah Tööstusdisainilahenduste**
- Bülletääni nr, kus registreering on avaldatud** 2006/01

(54) **Nimetus** Watch; Watch case; Watch dial

(55) **Reproduksioon**

DM/066906-01

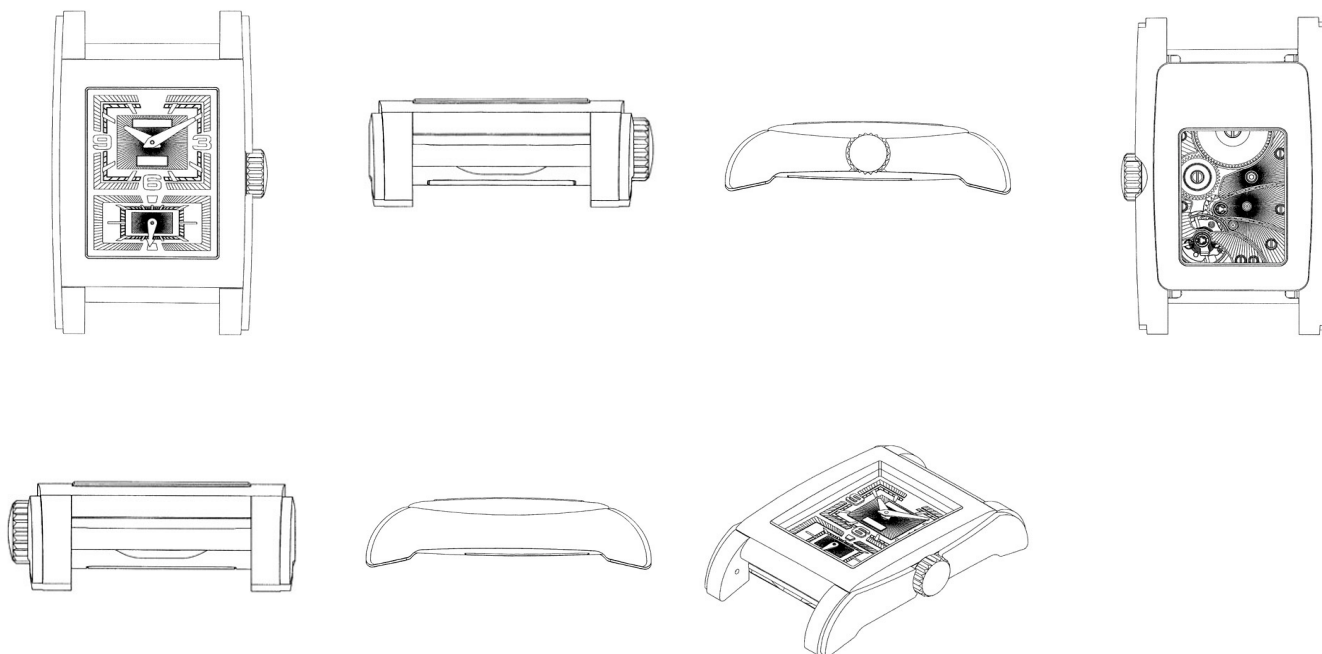

DM/066906-02

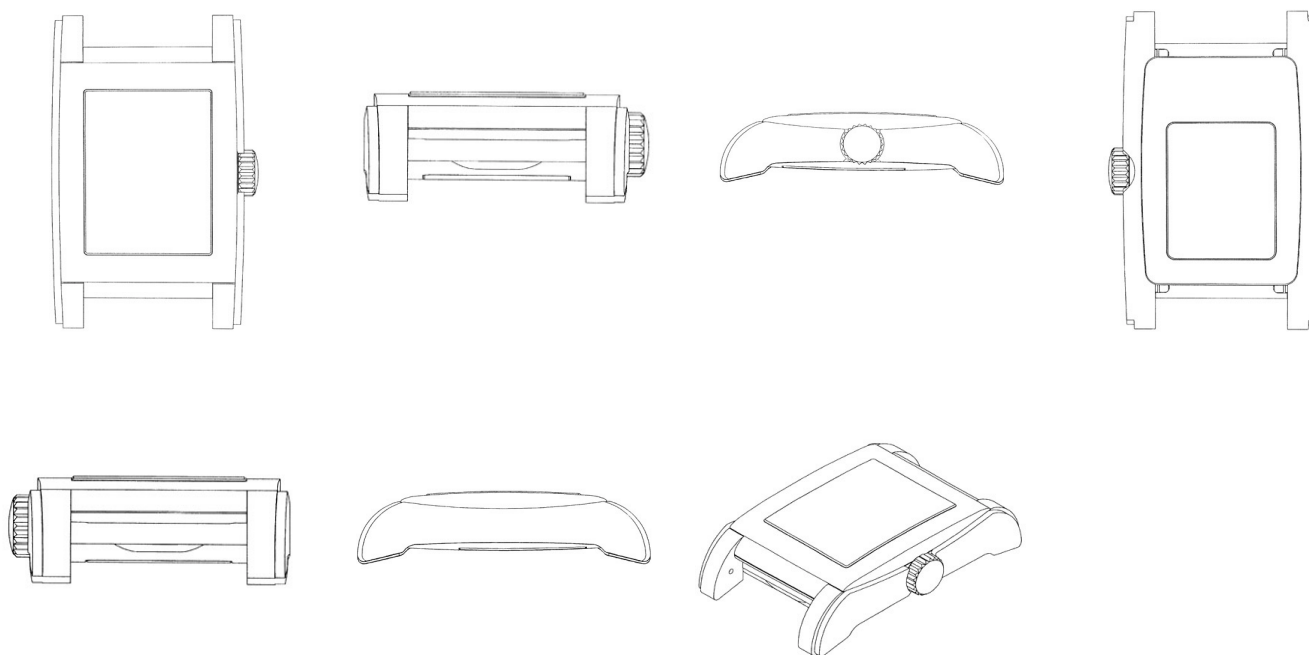

DM/066906-03

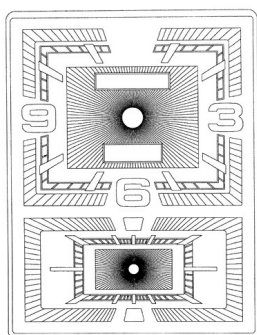

(11) Rahvusvah reg nr	DM/066910	(51) Klass: 10-07
(21) Rahvusvah reg jrk	H200600020	
(15) Registreeringu päev	17.08.2005	
(22) Esitamise päev	17.08.2005	
(28) Variantide arv	2	
(72) Autor	Xavier Perrenoud, XJC Sàrl, rue du Plan 3, CH-2000 Neuchâtel, CH	
(73) Omanik	MGI LUXURY GROUP SA, Nidaugasse 35, CH-2502 Bienne, CH	
WIPO Rahvusvah Tööstusdisainilahenduste		
Bülletääni nr, kus registreering on avaldatud	2006/01	

(54) **Nimetus** **Watch dials**

(55) **Reproduksioon**

DM/066910-01

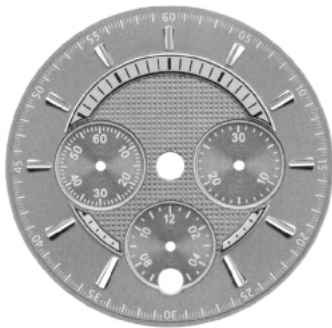

DM/066910-02



(11) Rahvusvah reg nr	DM/066910	(51) Klass: 10-07
(21) Rahvusvah reg jrk	H200600020A	
(15) Registreeringu päev	17.08.2005	
(22) Esitamise päev	17.08.2005	
(28) Variantide arv	1	
(72) Autor	Xavier Perrenoud, XJC Sàrl, rue du Plan 3, CH-2000 Neuchâtel, CH	
(73) Omanik	MGI LUXURY GROUP SA, Nidaugasse 35, CH-2502 Bienne, CH	
WIPO Rahvusvah Tööstusdisainilahenduste Bülletääni nr, kus registreering on avaldatud	2006/01	

(54) **Nimetus** **Watch dial**

(55) **Reproduksioon**

DM/066910-01



(11) Rahvusvah reg nr	DM/066910	(51) Klass: 10-07
(21) Rahvusvah reg jrk	H200600020B	
(15) Registreeringu päev	17.08.2005	
(22) Esitamise päev	17.08.2005	
(28) Variantide arv	1	
(72) Autor	Xavier Perrenoud, XJC Sàrl, rue du Plan 3, CH-2000 Neuchâtel, CH	
(73) Omanik	MGI LUXURY GROUP SA, Nidaugasse 35, CH-2502 Bienne, CH	
WIPO Rahvusvah Tööstusdisainilahenduste		
Bülletääni nr, kus registreering on avaldatud	2006/01	

(54) **Nimetus** **Watch dial**

(55) **Reproduksioon**

DM/066910-01

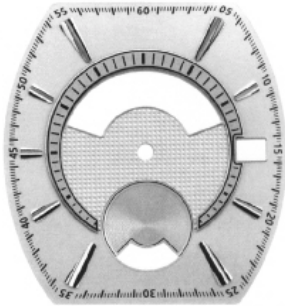

(11) Rahvusvah reg nr	DM/067116	(51) Klass: 02-07
(21) Rahvusvah reg jrk	H200600021	
(15) Registreeringu päev	08.08.2005	
(22) Esitamise päev	08.08.2005	
(28) Variantide arv	2	
(30) Prioriteediandmed	2005/00112, 17.02.2005, RO	
(72) Autor	Manaila Bogdan Nicolae, Strada Aleea Bahluiului, Nr. 16, Bl. 162, Et. 10, Ap. 120, Ploiesti, Jud. Prahova, RO	
(73) Omanik	MANAILA BOGDAN NICOLAE, Strada Aleea Bahluiului, Nr. 16, Bl. 162, Et. 10, Ap. 120, Ploiesti, Jud. Prahova, RO	
WIPO Rahvusvah Tööstusdisainilahenduste Bületääni nr, kus registreering on avaldatud	2006/01	

(54) **Nimetus** **Buckle**

(55) **Reproduksioon**

DM/067116-01

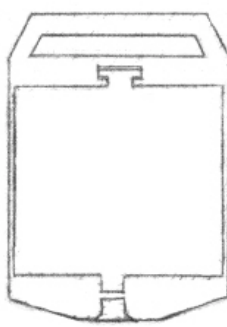
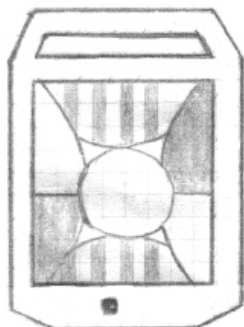

DM/067116-02

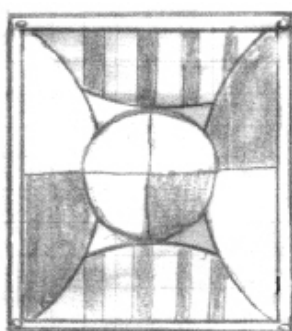

(11) Rahvusvah reg nr	DM/067142	(51) Klass: 10-07
(21) Rahvusvah reg jrk	H200500165	
(15) Registreeringu päev	01.11.2005	
(22) Esitamise päev	01.11.2005	
(28) Variantide arv	1	
(72) Autor	Patrick Joseph Lassigne, 23, chemin des Villarets, 2036 Cormondrèche, CH	
(73) Omanik	PATRICK JOSEPH LASSIGNE, 23, chemin des Villarets, CH-2036 Cormondrèche, CH	

**WIPO Rahvusvah Tööstusdisainilahenduste
Bülletääni nr, kus registreering on avaldatud** 2005/11

(54) **Nimetus** **Watch case with bracelet**

(55) **Reproduksioon**

DM/067142-01



(11) Rahvusvah reg nr	DM/067293	(51) Klass: 14-02
(21) Rahvusvah reg jrk	H200600010	
(15) Registreeringu päev	22.09.2005	
(22) Esitamise päev	22.09.2005	
(28) Variantide arv	1	
(72) Autor	Klaus Baumgartner, Sommerhofenstr. 53, D-71067 Sindelfingen, DE Jonas Vollmer, Senefelderstr. 78a, D-70176 Stuttgart, DE SIEMENS SCHWEIZ AG, Albisriederstrasse 245, CH-8047 Zürich, CH	
(73) Omanik		
WIPO Rahvusvah Tööstusdisainilahenduste		
Bülletääni nr, kus registreering on avaldatud	2005/12	

(54) **Nimetus** **Home automation device**

(55) **Reproduksioon**

DM/067293-01

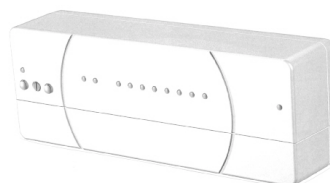

(11) Rahvusvah reg nr	DM/067294	(51) Klass: 14-02
(21) Rahvusvah reg jrk	H200600011	
(15) Registreeringu päev	22.09.2005	
(22) Esitamise päev	22.09.2005	
(28) Variantide arv	1	
(72) Autor	Klaus Baumgartner, Sommerhofenstr. 53, D-71067 Sindelfingen, DE Jonas Vollmer, Senefelderstr. 78a, D-70176 Stuttgart, DE SIEMENS SCHWEIZ AG, Albisriederstrasse 245, CH-8047 Zürich, CH	
(73) Omanik		
WIPO Rahvusvah Tööstusdisainilahenduste		
Bülletääni nr, kus registreering on avaldatud	2005/12	

(54) **Nimetus** **Home automation device**

(55) **Reproduksioon**

DM/067294-01

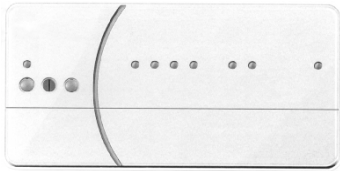

(11) Rahvusvah reg nr	DM/067295	(51) Klass: 14-02
(21) Rahvusvah reg jrk	H200600012	
(15) Registreeringu päev	22.09.2005	
(22) Esitamise päev	22.09.2005	
(28) Variantide arv	2	
(72) Autor	Klaus Baumgartner, Sommerhofenstr. 53, D-71067 Sindelfingen, DE Jonas Vollmer, Senefelderstr. 78a, D-70176 Stuttgart, DE SIEMENS SCHWEIZ AG, Albisriederstrasse 245, CH-8047 Zürich, CH	
(73) Omanik		
WIPO Rahvusvah Tööstusdisainilahenduste		
Bülletääni nr, kus registreering on avaldatud	2005/12	

(54) **Nimetus** **Home automation devices**

(55) **Reproduksioon**

DM/067295-01



DM/067295-02

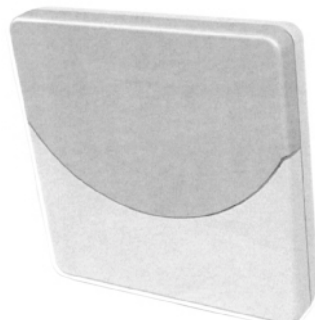
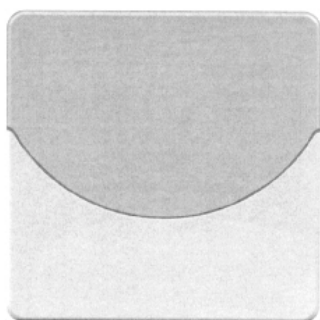

(11) Rahvusvah reg nr	DM/067296	(51) Klass: 14-02
(21) Rahvusvah reg jrk	H200600013	
(15) Registreeringu päev	22.09.2005	
(22) Esitamise päev	22.09.2005	
(28) Variantide arv	2	
(72) Autor	Klaus Baumgartner, Sommerhofenstr. 53, D-71067 Sindelfingen, DE Jonas Vollmer, Senefelderstr. 78a, D-70176 Stuttgart, DE SIEMENS SCHWEIZ AG, Albisriederstrasse 245, CH-8047 Zürich, CH	
(73) Omanik		
WIPO Rahvusvah Tööstusdisainilahenduste		
Bülletääni nr, kus registreering on avaldatud	2005/12	

(54) **Nimetus** **Home automation devices**

(55) **Reproduksioon**

DM/067296-01

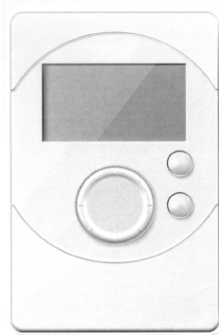

DM/067296-02

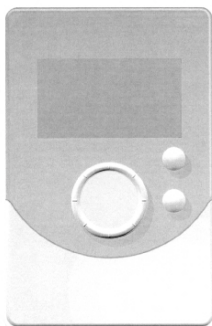

(11) Rahvusvah reg nr	DM/067297	(51) Klass: 14-02
(21) Rahvusvah reg jrk	H200600014	
(15) Registreeringu päev	22.09.2005	
(22) Esitamise päev	22.09.2005	
(28) Variantide arv	5	
(72) Autor	Klaus Baumgartner, Sommerhofenstr. 53, D-71067 Sindelfingen, DE Jonas Vollmer, Senefelderstr. 78a, D-70176 Stuttgart, DE SIEMENS SCHWEIZ AG, Albisriederstrasse 245, CH-8047 Zürich, CH	
(73) Omanik		
WIPO Rahvusvah Tööstusdisainilahenduste		
Bülletääni nr, kus registreering on avaldatud	2005/12	

(54) **Nimetus** **Home automation devices**

(55) **Reproduksioon**

DM/067297-01

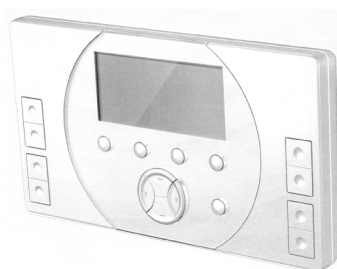

DM/067297-02

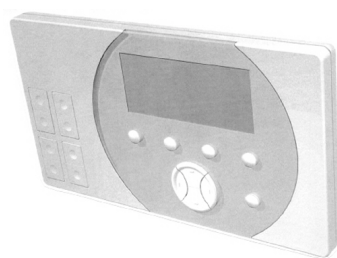
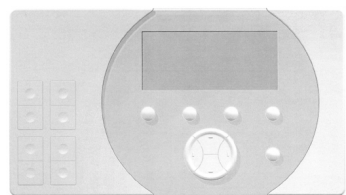

DM/067297-03

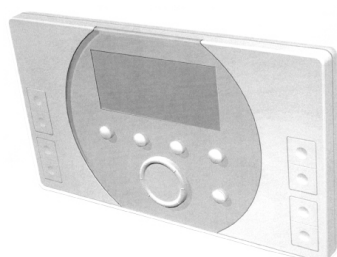
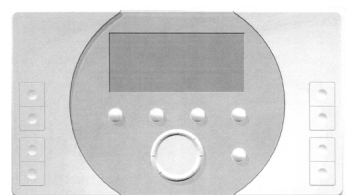

DM/067297-04

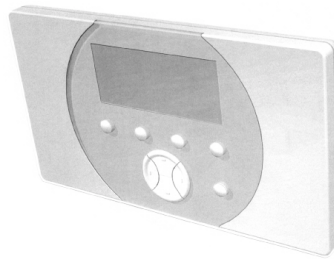
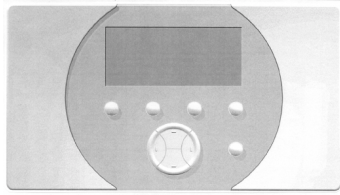

DM/067297-05

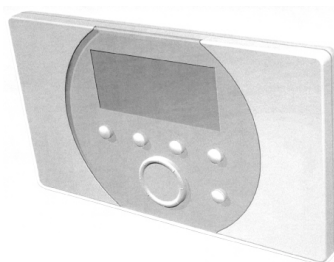
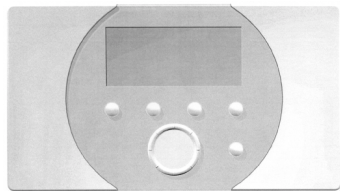

(11) Rahvusvah reg nr	DM/067349	(51) Klass: 10-07
(21) Rahvusvah reg jrk	H200600022	
(15) Registreeringu päev	23.12.2005	
(22) Esitamise päev	23.12.2005	
(28) Variantide arv	1	
(72) Autor	Patrick Joseph Lassigne, 23, chemin des Villarets, 2036 Cormondrèche, CH	
(73) Omanik	PATRICK JOSEPH LASSIGNE, 23, chemin des Villarets, CH-2036 Cormondrèche, CH	

**WIPO Rahvusvah Tööstusdisainilahenduste
Bülletääni nr, kus registreering on avaldatud** 2006/01

(54) **Nimetus** **Watch case with band**

(55) **Reproduksioon**

DM/067349-01



(11) Rahvusvah reg nr	DM/067357	(51) Klass: 10-02
(21) Rahvusvah reg jrk	H200600023	
(15) Registreeringu päev	19.12.2005	
(22) Esitamise päev	19.12.2005	
(28) Variantide arv	1	
(72) Autor	Nicole DUPONT, DUPONT DESIGN SA, Route des Jeunes 33, CH-1227 CAROUGE, CH	
(73) Omanik	ETA SA MANUFACTURE HORLOGERE SUISSE, CH-2540 GRENCHEN, CH	
WIPO Rahvusvah Tööstusdisainilahenduste Bülletääni nr, kus registreering on avaldatud	2006/01	

(54) **Nimetus** **Wristwatch**

(55) **Reproduksioon**

DM/067357-01



- (11) **Rahvusvah reg nr** **DM/067378** (51) Klass: **20-02**
- (21) **Rahvusvah reg jrk** H200600024
- (15) **Registreeringu päev** 22.12.2005
- (22) **Esitamise päev** 22.12.2005
- (28) **Variantide arv** 1
- (72) **Autor** Bruzzone Giancarlo, STUDIO BRUZZ, Via Buonaparte 12,
IT-20100 MILANO, IT
- (73) **Omanik** ETA SA MANUFACTURE HORLOGERE SUISSE,
CH-2540 GRENCHEN, CH
- WIPO Rahvusvah Tööstusdisainilahenduste**
Bülletääni nr, kus registreering on avaldatud 2006/01

(54) **Nimetus** **Display stand for watches**

(55) **Reproduksioon**

DM/067378-01

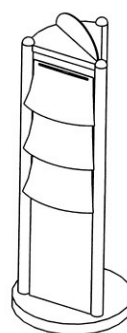
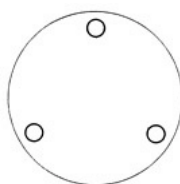
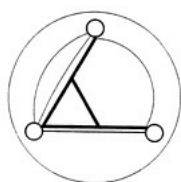
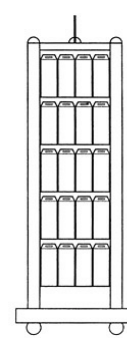
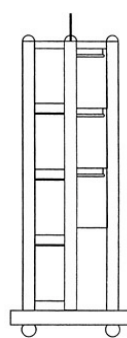
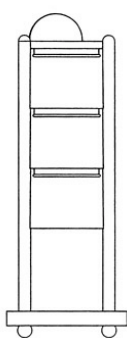
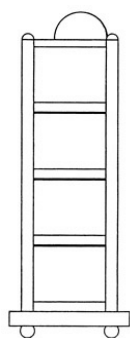

(11) **Rahvusvah reg nr****DM/067379**(51) Klass: **20-02**(21) **Rahvusvah reg jrk**

H200600025

(15) **Registreeringu päev**

22.12.2005

(22) **Esitamise päev**

22.12.2005

(28) **Variantide arv**

1

(72) **Autor**Bruzzone Giancarlo, STUDIO BRUZZ, Via Buonaparte 12,
IT-20100 MILANO, IT(73) **Omanik**ETA SA MANUFACTURE HORLOGERE SUISSE,
CH-2540 GRENCHEN, CH**WIPO Rahvusvah Tööstusdisainilahenduste****Bülletääni nr, kus registreering on avaldatud** 2006/01(54) **Nimetus****Display stand for watches**(55) **Reproduksioon**

DM/067379-01

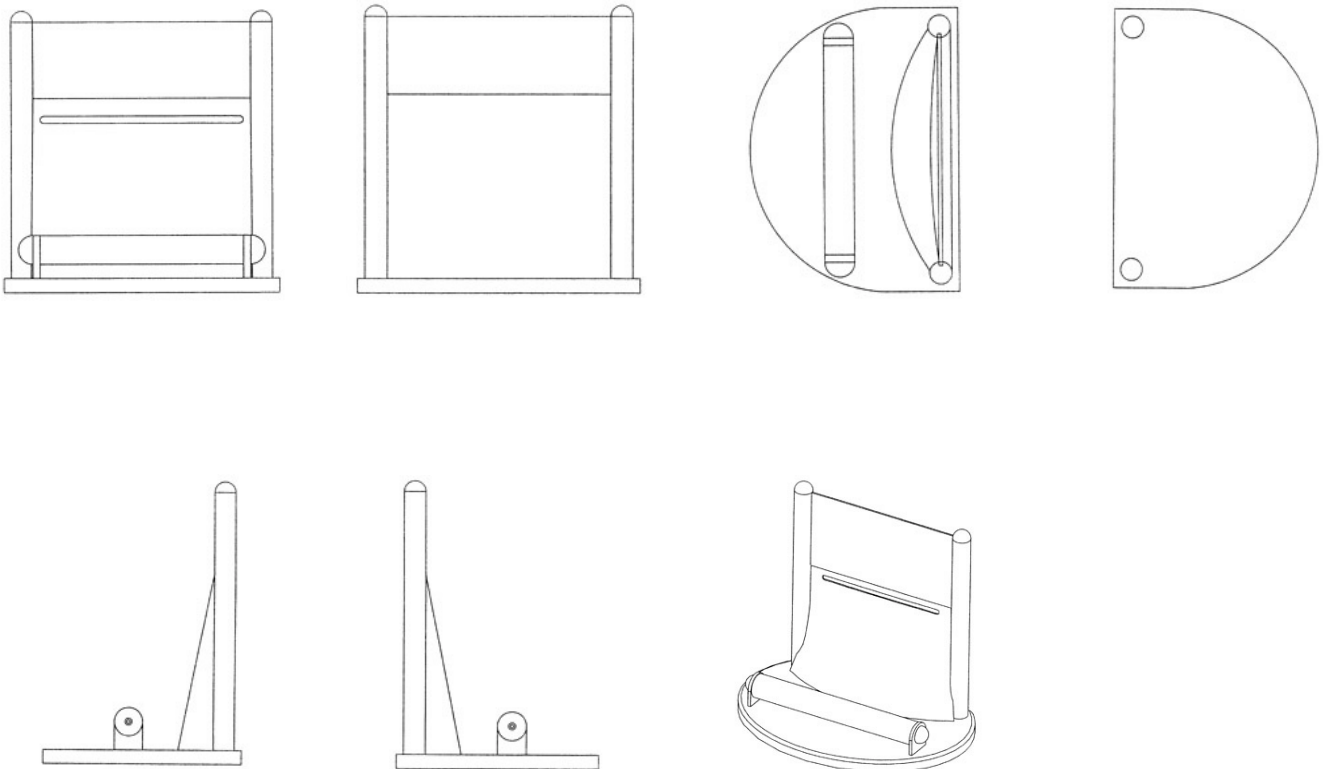

(11) Rahvusvah reg nr	DM/067391	(51) Klass: 20-03
(21) Rahvusvah reg jrk	H200600026	
(15) Registreeringu päev	06.01.2006	
(22) Esitamise päev	06.01.2006	
(28) Variantide arv	3	
(72) Autor	<i>Autori andmeid ei avalikustata</i>	
(73) Omanik	PALEKHA MYKOLA, ap. 24, Building 37 Mayakovskogo st., Kyiv 02222, UA	
WIPO Rahvusvah Tööstusdisainilahenduste Bülletääni nr, kus registreering on avaldatud	2006/01	

(54) **Nimetus** **Illuminated information and advertisement carrier module**

(55) **Reproduksioon**

DM/067391-01



DM/067391-02



DM/067391-03



(11) Rahvusvah reg nr	DM/067396	(51) Klass: 10-07
(21) Rahvusvah reg jrk	H200600027	
(15) Registreeringu päev	22.12.2005	
(22) Esitamise päev	22.12.2005	
(28) Variantide arv	1	
(72) Autor	Robert BERTRAND, Chemin Prés-Guëttins 42, CH-2520 LA NEUVEVILLE, CH	
(73) Omanik	TISSOT S.A., chemin des Tourelles 17, CH-2400 LE LOCLE, CH	
WIPO Rahvusvah Tööstusdisainilahenduste Bülletääni nr, kus registreering on avaldatud	2006/01	

(54) **Nimetus** **Watch case**

(55) **Reproduksioon**

DM/067396-01



(11) **Rahvusvah reg nr**

DM/067407

(51) Klass: **11-01**(21) **Rahvusvah reg jrk**

H200600043

(15) **Registreeringu päev**

18.10.2005

(22) **Esitamise päev**

18.10.2005

(28) **Variantide arv**

5

(72) **Autor**Jean-Pierre Schweizer, 7, Chemin des Bougeries,
CH-1228 Plan-les-Ouates, CH(73) **Omanik**Jean-Pierre Schweizer, 7, Chemin des Bougeries,
CH-1228 Plan-les-Ouates, CH**WIPO Rahvusvah Tööstusdisainilahenduste****Bülletääni nr, kus registreering on avaldatud** 2006/03(54) **Nimetus**

Rings

(55) **Reproduksioon**

DM/067407-01

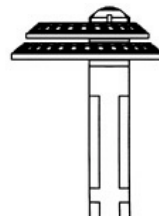
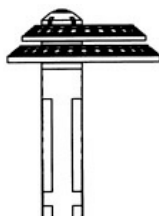
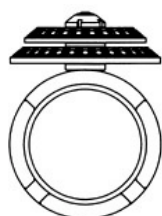
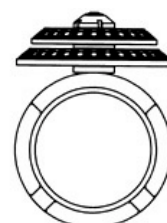
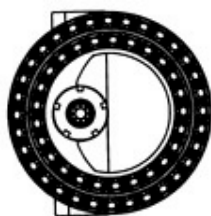

DM/067407-02

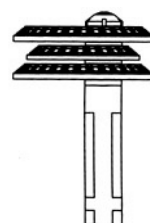
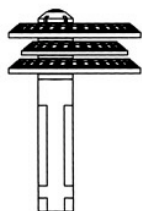
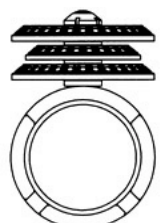
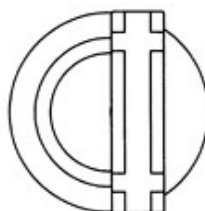
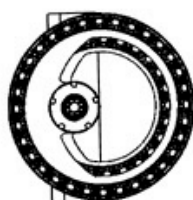

DM/067407-03

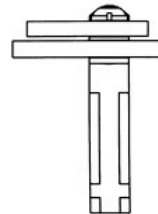
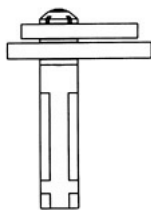
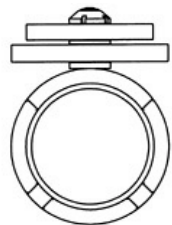
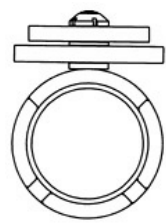
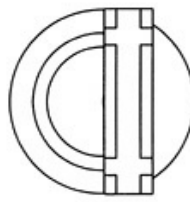
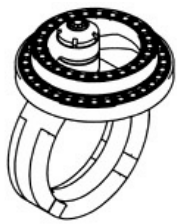

DM/067407-04

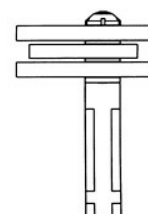
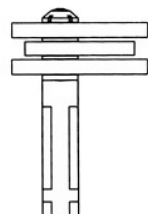
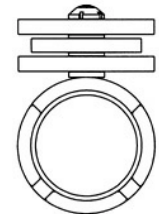
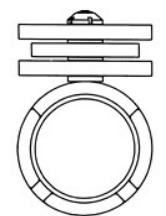
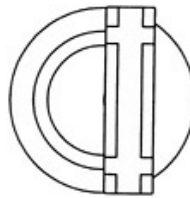
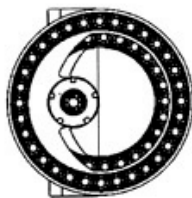

DM/067407-05

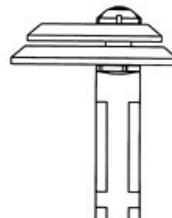
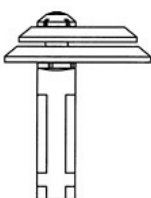
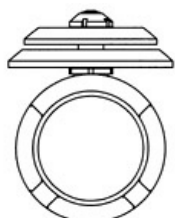
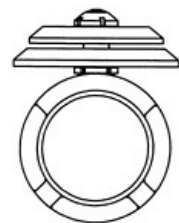
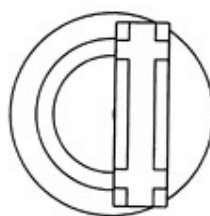
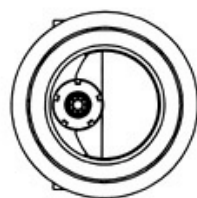

(11) Rahvusvah reg nr	DM/067416	(51) Klass: 10-02
(21) Rahvusvah reg jrk	H200600028	
(15) Registreeringu päev	26.01.2006	
(22) Esitamise päev	26.01.2006	
(28) Variantide arv	1	
(72) Autor	Marco DRAGOTTA, SWATCHLAB, Via Archimede 8, IT-20129 MILANO, IT	
(73) Omanik	SWATCH AG (SWATCH SA) (SWATCH LTD.), 94, Rue Jakob Stämpfli, CH-2502 BIENNE, CH	
WIPO Rahvusvah Tööstusdisainilahenduste Bülletääni nr, kus registreering on avaldatud	2006/01	

(54) **Nimetus** **Wristwatch**

(55) **Reproduksioon**

DM/067416-01



(11) Rahvusvah reg nr	DM/067419	(51) Klass: 10-02
(21) Rahvusvah reg jrk	H200600029	
(15) Registreeringu päev	26.01.2006	
(22) Esitamise päev	26.01.2006	
(28) Variantide arv	1	
(72) Autor	Marco DRAGOTTA, SWATCHLAB, Via Archimede 8, IT-20129 MILANO, IT	
(73) Omanik	SWATCH AG (SWATCH SA) (SWATCH LTD.), 94, Rue Jakob Stämpfli, CH-2502 BIENNE, CH	

**WIPO Rahvusvah Tööstusdisainilahenduste
Bülletääni nr, kus registreering on avaldatud** 2006/01

(54) **Nimetus** **Wristwatch**

(55) **Reproduksioon**

DM/067419-01



(11) Rahvusvah reg nr	DM/067421	(51) Klass: 10-02
(21) Rahvusvah reg jrk	H200600030	
(15) Registreeringu päev	26.01.2006	
(22) Esitamise päev	26.01.2006	
(28) Variantide arv	1	
(72) Autor	Ciara Baudet, DUPONT DESIGN SA, Route des Jeunes 33, CH-1227 CAROUGE, CH	
(73) Omanik	SWATCH AG (SWATCH SA) (SWATCH LTD.), 94, Rue Jakob Stämpfli, CH-2502 BIENNE, CH	
WIPO Rahvusvah Tööstusdisainilahenduste Bülletääni nr, kus registreering on avaldatud	2006/01	

(54) **Nimetus** **Wristwatch**

(55) **Reproduksioon**

DM/067421-01



(11) Rahvusvah reg nr	DM/067426	(51) Klass: 10-02
(21) Rahvusvah reg jrk	H200600031	
(15) Registreeringu päev	26.01.2006	
(22) Esitamise päev	26.01.2006	
(28) Variantide arv	1	
(72) Autor	Fabrice DUPONT, DUPONT DESIGN SA, Route des Jeunes 33, CH-1227 CAROUGE, CH	
(73) Omanik	SWATCH AG (SWATCH SA) (SWATCH LTD.), 94, Rue Jakob Stämpfli, CH-2502 BIENNE, CH	
WIPO Rahvusvah Tööstusdisainilahenduste Bülletääni nr, kus registreering on avaldatud	2006/01	

(54) **Nimetus** **Wristwatch**

(55) **Reproduksioon**

DM/067426-01



(11) Rahvusvah reg nr	DM/067456	(51) Klass: 10-02
(21) Rahvusvah reg jrk	H200600033	
(15) Registreeringu päev	13.02.2006	
(22) Esitamise päev	13.02.2006	
(28) Variantide arv	1	
(72) Autor	Marco DRAGOTTA, SWATCHLAB, Via Archimede 8, IT-20129 MILANO, IT	
(73) Omanik	SWATCH AG (SWATCH SA) (SWATCH LTD.), 94, Rue Jakob Stämpfli, CH-2502 BIENNE, CH	
WIPO Rahvusvah Tööstusdisainilahenduste Bülletääni nr, kus registreering on avaldatud	2006/02	

(54) **Nimetus** **Wristwatch**

(55) **Reproduksioon**

DM/067456-01



(11) Rahvusvah reg nr	DM/067503	(51) Klass: 13-03
(21) Rahvusvah reg jrk	H200600034	
(15) Registreeringu päev	05.01.2006	
(22) Esitamise päev	05.01.2006	
(28) Variantide arv	1	
(72) Autor	Abdulhalik Bugday, Mehmet Akif Ersoy Mah. Kuskaya Mevkii 2007 Sok. Bila no. Tasoluk Arnavutkoy Gaziosmanpasa, ISTANBUL, TR	
(73) Omanik	EL-BI ELEKTRIK ITHALAT IHRACAT SANAYI TICARET LIMITED SIRKETI, Mehmet Akif Ersoy Mah. Kuskaya Mevkii 2007 Sok. Bila No Tasoluk-Arnavutkoy-Gaziosmanpasa, Istanbul, TR	
WIPO Rahvusvah Tööstusdisainilahenduste Bülletääni nr, kus registreering on avaldatud	2006/02	

(54) **Nimetus** **Electric switch**

(55) **Reproduksioon**

DM/067503-01

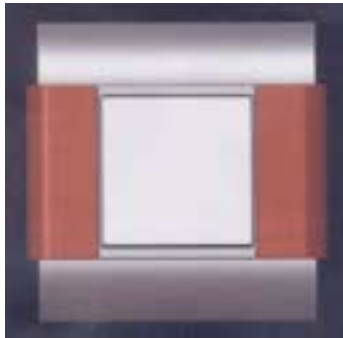

(11) Rahvusvah reg nr	DM/067504	(51) Klass: 24-01
(21) Rahvusvah reg jrk	H200600035	
(15) Registreeringu päev	24.01.2006	
(22) Esitamise päev	24.01.2006	
(28) Variantide arv	1	
(72) Autor	Martin Frischknecht, El. Ing.HTL, Breilen 67, CH-3636 Forst b. Längenbühl, CH	
(73) Omanik	FRITONEX AG, Breiten 67, CH-3636 Forst b. Längenbühl, CH Martin Frischknecht, EL.ING.HTL, Breiten 67, CH-3636 Forst b. Längenbühl, CH	

**WIPO Rahvusvah Tööstusdisainilahenduste
Bülletääni nr, kus registreering on avaldatud** 2006/02

(54) **Nimetus** **Medical equipment, namely apparatus for the transcutaneous electronic stimulation of nerves used for self-treatment of symptoms and pain**

(55) **Reproduktsoon**

DM/067504-01



(11) Rahvusvah reg nr	DM/067512	(51) Klass: 10-02
(21) Rahvusvah reg jrk	H200600036	
(15) Registreeringu päev	15.02.2006	
(22) Esitamise päev	15.02.2006	
(28) Variantide arv	1	
(72) Autor	Rossana BOFFI, SWATCHLAB, Via Archimede 6, IT-20129 MILANO, IT	
(73) Omanik	SWATCH AG (SWATCH SA) (SWATCH LTD.), 94, Rue Jakob Stämpfli, CH-2502 BIENNE, CH	
WIPO Rahvusvah Tööstusdisainilahenduste Bülletääni nr, kus registreering on avaldatud	2006/02	

(54) **Nimetus** **Wristwatch**

(55) **Reproduksioon**

DM/067512-01



(11) Rahvusvah reg nr	DM/067516	(51) Klass: 10-02
(21) Rahvusvah reg jrk	H200600037	
(15) Registreeringu päev	15.02.2006	
(22) Esitamise päev	15.02.2006	
(28) Variantide arv	1	
(72) Autor	Marco DRAGOTTA, SWATCHLAB, Via Archimede 8, IT-20129 MILANO, IT	
(73) Omanik	SWATCH AG (SWATCH SA) (SWATCH LTD.), 94, Rue Jakob Stämpfli, CH-2502 BIENNE, CH	
WIPO Rahvusvah Tööstusdisainilahenduste Bülletääni nr, kus registreering on avaldatud	2006/02	

(54) **Nimetus** **Wristwatch**

(55) **Reproduksioon**

DM/067516-01



(11) Rahvusvah reg nr	DM/067517	(51) Klass: 10-02
(21) Rahvusvah reg jrk	H200600038	
(15) Registreeringu päev	10.02.2006	
(22) Esitamise päev	10.02.2006	
(28) Variantide arv	1	
(72) Autor	Léonie COCQUIO, DUPONT DESIGN SA, Route des Jeunes 33, CH-1227 CAROUGE, CH	
(73) Omanik	SWATCH AG (SWATCH SA) (SWATCH LTD.), 94, Rue Jakob Stämpfli, CH-2502 BIENNE, CH	
WIPO Rahvusvah Tööstusdisainilahenduste Bülletääni nr, kus registreering on avaldatud	2006/02	

(54) **Nimetus** **Wristwatch**

(55) **Reproduksioon**

DM/067517-01



(11) Rahvusvah reg nr	DM/067518	(51) Klass: 10-02
(21) Rahvusvah reg jrk	H200600039	
(15) Registreeringu päev	15.02.2006	
(22) Esitamise päev	15.02.2006	
(28) Variantide arv	1	
(72) Autor	Rossana BOFFI, SWATCHLAB, Via Archimede 6, IT-20129 MILANO, IT	
(73) Omanik	SWATCH AG (SWATCH SA) (SWATCH LTD.), 94, Rue Jakob Stämpfli, CH-2502 BIENNE, CH	
WIPO Rahvusvah Tööstusdisainilahenduste Bülletääni nr, kus registreering on avaldatud	2006/02	

(54) **Nimetus** **Wristwatch**

(55) **Reproduksioon**

DM/067518-01



(11) Rahvusvah reg nr	DM/067519	(51) Klass: 10-02
(21) Rahvusvah reg jrk	H200600040	
(15) Registreeringu päev	15.02.2006	
(22) Esitamise päev	15.02.2006	
(28) Variantide arv	1	
(72) Autor	Alessandra Fornari, SWATCHLAB, Via Archimede 6, IT-20129 Milano, IT	
(73) Omanik	SWATCH AG (SWATCH SA) (SWATCH LTD.), 94, Rue Jakob Stämpfli, CH-2502 BIENNE, CH	
WIPO Rahvusvah Tööstusdisainilahenduste Bülletääni nr, kus registreering on avaldatud	2006/02	

(54) **Nimetus** **Wristwatch**

(55) **Reproduksioon**

DM/067519-01



(11) Rahvusvah reg nr	DM/067520	(51) Klass: 10-02
(21) Rahvusvah reg jrk	H200600041	
(15) Registreeringu päev	15.02.2006	
(22) Esitamise päev	15.02.2006	
(28) Variantide arv	1	
(72) Autor	Ciara Baudet, DUPONT DESIGN SA, Route des Jeunes 33, CH-1227 CAROUGE, CH	
(73) Omanik	SWATCH AG (SWATCH SA) (SWATCH LTD.), 94, Rue Jakob Stämpfli, CH-2502 BIENNE, CH	
WIPO Rahvusvah Tööstusdisainilahenduste Bülletääni nr, kus registreering on avaldatud	2006/02	

(54) **Nimetus** **Wristwatch**

(55) **Reproduksioon**

DM/067520-01



(11) Rahvusvah reg nr	DM/067521	(51) Klass: 10-02
(21) Rahvusvah reg jrk	H200600042	
(15) Registreeringu päev	15.02.2006	
(22) Esitamise päev	15.02.2006	
(28) Variantide arv	1	
(72) Autor	Marco Dragotta, SWATCHLAB, Via Archimede 6, IT-20129 Milano, IT	
(73) Omanik	SWATCH AG (SWATCH SA) (SWATCH LTD.), 94, Rue Jakob Stämpfli, CH-2502 BIENNE, CH	
WIPO Rahvusvah Tööstusdisainilahenduste Bülletääni nr, kus registreering on avaldatud	2006/02	

(54) **Nimetus** **Wristwatch**

(55) **Reproduksioon**

DM/067521-01



(11) Rahvusvah reg nr	DM/067543	(51) Klass: 10-02
(21) Rahvusvah reg jrk	H200600044	
(15) Registreeringu päev	02.03.2006	
(22) Esitamise päev	02.03.2006	
(28) Variantide arv	1	
(72) Autor	Adelina BISSOLO, SWATCHLAB, Via Archimede 6, IT-20129 Milano, IT	
(73) Omanik	SWATCH AG (SWATCH SA) (SWATCH LTD.), 94, Rue Jakob Stämpfli, CH-2502 BIENNE, CH	
WIPO Rahvusvah Tööstusdisainilahenduste Bülletääni nr, kus registreering on avaldatud	2006/03	

(54) **Nimetus** **Wristwatch**

(55) **Reproduksioon**

DM/067543-01



(11) Rahvusvah reg nr	DM/067544	(51) Klass: 10-02
(21) Rahvusvah reg jrk	H200600045	
(15) Registreeringu päev	02.03.2006	
(22) Esitamise päev	02.03.2006	
(28) Variantide arv	1	
(72) Autor	Danilo SALA, SWATCHLAB, Via Archimede 6, IT-20129 MILANO, IT	
(73) Omanik	SWATCH AG (SWATCH SA) (SWATCH LTD.), 94, Rue Jakob Stämpfli, CH-2502 BIENNE, CH	
WIPO Rahvusvah Tööstusdisainilahenduste Bülletääni nr, kus registreering on avaldatud	2006/03	

(54) **Nimetus** **Wristwatch**

(55) **Reproduksioon**

DM/067544-01



(11) Rahvusvah reg nr	DM/067584	(51) Klass: 10-07
(21) Rahvusvah reg jrk	H200600046	
(15) Registreeringu päev	28.03.2006	
(22) Esitamise päev	28.03.2006	
(28) Variantide arv	3	
(72) Autor	Hakim EL KADIRI, Rue de Neuchâtel, CH-2072 ST-BLAISE, CH	
(73) Omanik	ENDURA AG (ENDURA SA)(ENDURA LTD.), Längfeldweg 119, CH-2504 Biel-Bienne, CH	

**WIPO Rahvusvah Tööstusdisainilahenduste
Bülletääni nr, kus registreering on avaldatud** 2006/03

(54) **Nimetus** **Watch cases**

(55) **Reproduksioon**

DM/067584-01



DM/067584-02



DM/067584-03



(11) **Rahvusvah reg nr**

DM/067589

(51) Klass: **10-02**(21) **Rahvusvah reg jrk**

H200600049

(15) **Registreeringu päev**

28.03.2006

(22) **Esitamise päev**

28.03.2006

(28) **Variantide arv**

2

(72) **Autor**Arlette Elisa EMCH DUCOMMUN, rue des Mornets 31,
CH-2520 LA NEUVILLE, CH(73) **Omanik**LÉON HATOT SA (LÉON HATOT AG)(LÉON HATOT LTD.),
Viaduktstrasse 30, CH-2500 BIEL/BIENNE, CH**WIPO Rahvusvah Tööstusdisainilahenduste
Bülletääni nr, kus registreering on avaldatud**

2006/03

(54) **Nimetus****Wristwatches**(55) **Reproduksioon**

DM/067589-01



DM/067589-02



(11) Rahvusvah reg nr	DM/067604	(51) Klass: 20-02
(21) Rahvusvah reg jrk	H200600050	
(15) Registreeringu päev	16.12.2005	
(22) Esitamise päev	16.12.2005	
(28) Komplektide arv	1	
(72) Autor	Hans-Albert KUFFERATH, Gartenstrasse 13, CH-5600 Lenzburg, CH	
(73) Omanik	ARTOZ-PAPIER AG, 23, Ringstrasse West, CH-5600 Lenzburg, CH	
WIPO Rahvusvah Tööstusdisainilahenduste Bülletääni nr, kus registreering on avaldatud	2006/03	

(54) **Nimetus** **Set of modular boxes for display and sale of stationery**

(55) **Reproduksioon**

DM/067604-01



(11) **Rahvusvah reg nr**

DM/067608

(51) Klass: **09-01**(21) **Rahvusvah reg jrk**

H200600052

(15) **Registreeringu päev**

08.03.2006

(22) **Esitamise päev**

08.03.2006

(28) **Variantide arv**

1

(30) **Prioriteediandmed**

132203, 29.09.2005, CH

(72) **Autor***Autori andmeid ei avalikustata*(73) **Omanik**

GA MODEFINE S.A., Via Penate 4, CH-6850 Mendrisio, CH

WIPO Rahvusvah Tööstusdisainilahenduste**Bülletääni nr, kus registreering on avaldatud** 2006/03(54) **Nimetus****Perfume bottle**(55) **Reproduksioon**

DM/067608-01

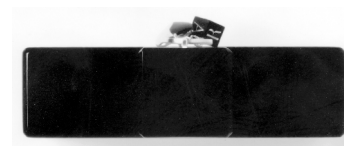

(11) Rahvusvah reg nr	DM/067621	(51) Klass: 11-01
(21) Rahvusvah reg jrk	H200600053	
(15) Registreeringu päev	28.03.2006	
(22) Esitamise päev	28.03.2006	
(28) Variantide arv	3	
(72) Autor	Arlette Elsa EMCH DUCOMMUN, Rue des Mornets 31, CH-2520 LA NEUVEVILLE, CH	
(73) Omanik	MONTRES BREGUET S.A., CH-1344 L'ABBAYE, CH	
WIPO Rahvusvah Tööstusdisainilahenduste Bülletääni nr, kus registreering on avaldatud	2006/03	

(54) **Nimetus** **Jewellery, including necklace, ring, earrings**

(55) **Reproduksioon**

DM/067621-01



DM/067621-02



DM/067621-03



(11) Rahvusvah reg nr	DM/067622	(51) Klass: 10-07
(21) Rahvusvah reg jrk	H200600054	
(15) Registreeringu päev	28.03.2006	
(22) Esitamise päev	28.03.2006	
(28) Variantide arv	1	
(72) Autor	Lionel a Marca, Chemin de l'Etang 6, CH-1094 PAUDEX, CH	
(73) Omanik	BLANCPAIN SA, Le Rocher 12, CH-1348 LE BRASSUS, CH	
WIPO Rahvusvah Tööstusdisainilahenduste		
Bülletääni nr, kus registreering on avaldatud	2006/03	

(54) **Nimetus** **Watch dial**

(55) **Reproduksioon**

DM/067622-01



(11) Rahvusvah reg nr	DM/067622	(51) Klass: 10-07
(21) Rahvusvah reg jrk	H200600054A	
(15) Registreeringu päev	28.03.2006	
(22) Esitamise päev	28.03.2006	
(28) Variantide arv	1	
(72) Autor	Lionel a Marca, Chemin de l'Etang 6, CH-1094 PAUDEX, CH	
(73) Omanik	BLANCPAIN SA, Le Rocher 12, CH-1348 LE BRASSUS, CH	
WIPO Rahvusvah Tööstusdisainilahenduste Bülletääni nr, kus registreering on avaldatud	2006/03	

(54) **Nimetus** **Watch dial**

(55) **Reproduksioon**

DM/067622-01



(11) Rahvusvah reg nr	DM/067622	(51) Klass: 10-07
(21) Rahvusvah reg jrk	H200600054B	
(15) Registreeringu päev	28.03.2006	
(22) Esitamise päev	28.03.2006	
(28) Variantide arv	1	
(72) Autor	Lionel a Marca, Chemin de l'Etang 6, CH-1094 PAUDEX, CH	
(73) Omanik	BLANCPAIN SA, Le Rocher 12, CH-1348 LE BRASSUS, CH	
WIPO Rahvusvah Tööstusdisainilahenduste Bülletääni nr, kus registreering on avaldatud	2006/03	

(54) **Nimetus** **Watch dial**

(55) **Reproduksioon**

DM/067622-01



(11) Rahvusvah reg nr	DM/067622	(51) Klass: 10-07
(21) Rahvusvah reg jrk	H200600054C	
(15) Registreeringu päev	28.03.2006	
(22) Esitamise päev	28.03.2006	
(28) Variantide arv	1	
(72) Autor	Lionel a Marca, Chemin de l'Etang 6, CH-1094 PAUDEX, CH	
(73) Omanik	BLANCPAIN SA, Le Rocher 12, CH-1348 LE BRASSUS, CH	
WIPO Rahvusvah Tööstusdisainilahenduste Bülletääni nr, kus registreering on avaldatud	2006/03	

(54) **Nimetus** **Watch dial**

(55) **Reproduksioon**

DM/067622-01



(11) Rahvusvah reg nr	DM/067622	(51) Klass: 10-02
(21) Rahvusvah reg jrk	H200600054D	
(15) Registreeringu päev	28.03.2006	
(22) Esitamise päev	28.03.2006	
(28) Variantide arv	1	
(72) Autor	Lionel a Marca, Chemin de l'Etang 6, CH-1094 PAUDEX, CH	
(73) Omanik	BLANCPAIN SA, Le Rocher 12, CH-1348 LE BRASSUS, CH	
WIPO Rahvusvah Tööstusdisainilahenduste		
Bülletääni nr, kus registreering on avaldatud	2006/03	

(54) **Nimetus** **Wristwatch**

(55) **Reproduksioon**

DM/067622-01



(11) Rahvusvah reg nr	DM/067623	(51) Klass: 02-07
(21) Rahvusvah reg jrk	H200600055	
(15) Registreeringu päev	28.03.2006	
(22) Esitamise päev	28.03.2006	
(28) Variantide arv	1	
(72) Autor	Arlette Elsa EMCH DUCOMMUN, Rue des Mornets 31, CH-2520 LA NEUVEVILLE, CH	
(73) Omanik	BLANCPAIN SA, Le Rocher 12, CH-1348 LE BRASSUS, CH	
WIPO Rahvusvah Tööstusdisainilahenduste Bülletääni nr, kus registreering on avaldatud	2006/03	

(54) **Nimetus** **Cuff links**

(55) **Reproduksioon**

DM/067623-01



(11) Rahvusvah reg nr	DM/067623	(51) Klass: 02-07
(21) Rahvusvah reg jrk	H200600055A	
(15) Registreeringu päev	28.03.2006	
(22) Esitamise päev	28.03.2006	
(28) Variantide arv	1	
(72) Autor	Arlette Elsa EMCH DUCOMMUN, Rue des Mornets 31, CH-2520 LA NEUVEVILLE, CH	
(73) Omanik	BLANCPAIN SA, Le Rocher 12, CH-1348 LE BRASSUS, CH	
WIPO Rahvusvah Tööstusdisainilahenduste Bülletääni nr, kus registreering on avaldatud	2006/03	

(54) **Nimetus** **Cuff links**

(55) **Reproduksioon**

DM/067623-01

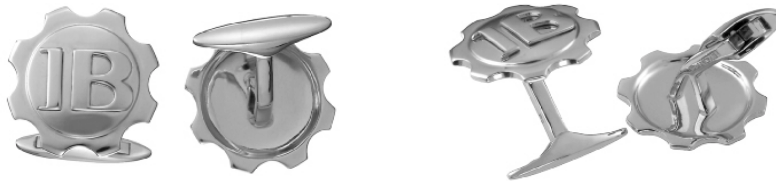

(11) Rahvusvah reg nr	DM/067623	(51) Klass: 02-07
(21) Rahvusvah reg jrk	H200600055B	
(15) Registreeringu päev	28.03.2006	
(22) Esitamise päev	28.03.2006	
(28) Variantide arv	1	
(72) Autor	Arlette Elsa EMCH DUCOMMUN, Rue des Mornets 31, CH-2520 LA NEUVEVILLE, CH	
(73) Omanik	BLANCPAIN SA, Le Rocher 12, CH-1348 LE BRASSUS, CH	
WIPO Rahvusvah Tööstusdisainilahenduste Bülletääni nr, kus registreering on avaldatud	2006/03	

(54) **Nimetus** **Cuff links**

(55) **Reproduksioon**

DM/067623-01



(11) Rahvusvah reg nr	DM/067645	(51) Klass: 20-02
(21) Rahvusvah reg jrk	H200600057	
(15) Registreeringu päev	03.01.2006	
(22) Esitamise päev	03.01.2006	
(28) Variantide arv	1	
(72) Autor	Hans-Albert KUFFERATH, Gartenstrasse 13, CH-5600 Lenzburg, CH	
(73) Omanik	ARTOZ-PAPIER AG, 23, Ringstrasse West, CH-5600 Lenzburg, CH	
WIPO Rahvusvah Tööstusdisainilahenduste		
Bülletääni nr, kus registreering on avaldatud	2006/03	

(54) **Nimetus** **Stationery display**

(55) **Reproduksioon**

DM/067645-01

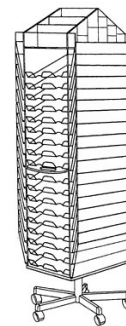
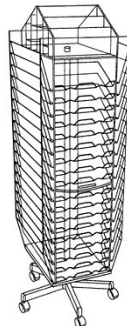
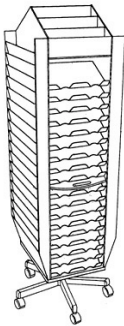

(11) Rahvusvah reg nr	DM/067708	(51) Klass: 10-07
(21) Rahvusvah reg jrk	H200600100	
(15) Registreeringu päev	29.03.2006	
(22) Esitamise päev	29.03.2006	
(28) Variantide arv	1	
(72) Autor	Eddy SCHOEPFER, Les Ouches-2023 Gorgier, CH	
(73) Omanik	BREITLING SA, Schlachthausstrasse 2, case postale 1132, CH-2540 Granges, CH	
WIPO Rahvusvah Tööstusdisainilahenduste Bülletääni nr, kus registreering on avaldatud	2006/08	

(54) **Nimetus** Watch case

(55) **Reproduksioon**

DM/067708-01



(11) **Rahvusvah reg nr**

DM/068058

(51) Klass: **10-02**(21) **Rahvusvah reg jrk**

H200600101

(15) **Registreeringu päev**

17.07.2006

(22) **Esitamise päev**

30.03.2006

(28) **Variantide arv**

1

(72) **Autor**

Marcello Binda, Via Cusani, Milan, IT

(73) **Omanik**MONTRES WYLER SA GENÈVE, Boulevard James-Fazy 4,
CH-1211 Genève, CH**WIPO Rahvusvah Tööstusdisainilahenduste
Bülletääni nr, kus registreering on avaldatud**

2006/08

(54) **Nimetus**

Wristwatch

(55) **Reproduksioon**

DM/068058-01



III. REGISTREERINGU KEHTIVUSE PIKENDAMINE

(11)	(18)
00587	17.10.2011
00588	17.10.2011
00589	17.10.2011
00590	08.10.2011
00604	07.11.2011
00608	28.11.2011
00609	13.08.2011
00617	17.08.2011

IV. TÖÖSTUSDISAINILAHENDUSE ÜLEMINEK

Reg nr	Uue omaniku andmed	Registrikande jõustumise päev
00644	AS A. Le Coq Tartu Õlletehas, Tähtvere 56/62, 50050 Tartu, EE	18.10.2006

VI. MUUD REGISTREERINGU ANDMETE MUUDATUSED

Reg nr	Muudetud andmed	Registrikande jõustumise päev
00644	Reet Maasikamäe OÜ Kaitsepurus, Mulla 4-3, 10611 Tallinn, EE	18.10.2006

XI. TÖÖSTUSDISAINILAHENDUSE KUSTUTAMINE REGISTRIST

"Tööstusdisaini kaitse seaduse" paragrahvi 77 lõike 1 alusel on registrist kustutatud järgmised tööstusdisainilahendused:

Reg nr	Kustutamise jõustumise päev
--------	-----------------------------

00544	06.02.2006
00545	07.03.2006

XII. LOENDID

REGISTREERITUD TÖÖSTUSDISAINILAHENDUSTE SÜSTEMAATILINE LOEND

Rahvusvahelise klassifikatsiooni klass ja alaklass(id)	Registreerimis-taotluse number	Registreeringu number
--	--------------------------------	-----------------------

06-11	D200600031	01177	14-03	D200600044	01182
06-12	D200600031	01177	14-03	D200600045	01183
07-06	D200600051	01189	14-03	D200600046	01184
08-06	D200600048	01186	14-03	D200600047	01185
08-06	D200600049	01187	14-03	D200600067	01198
08-09	D200600049	01187	14-03	D200600068	01199
09-01	D200500093	01173	15-03	D200600034	01179
09-01	D200600050	01188	19-04	D200600039	01180
10-04	D200600028	01176	21-01	D200600059	01195
10-05	D200600028	01176	21-04	D200600052	01190
10-06	D200600028	01176	21-04	D200600053	01191
11-02	D200600033	01178	21-04	D200600061	01197
12-06	D200600069	01200	25-01	D200600060	01196
12-07	D200600028	01176	25-02	D200600060	01196
14-03	D200600015	01174	25-03	D200600056	01192
14-03	D200600021	01181	25-03	D200600057	01193
14-03	D200600022	01175	25-03	D200600058	01194
14-03	D200600028	01176			

REGISTREERITUD TÖÖSTUSDISAINILAHENDUSTE REGISTREERIMISTAOTLUSTE NUMBRILINE LOEND

Registreerimis-taotluse number	Registreeringu number	Rahvusvahelise klassifikatsiooni klass(id) ja alaklass(id)
--------------------------------	-----------------------	--

D200500093	01173	09-01	D200600048	01186	08-06
D200600015	01174	14-03	D200600049	01187	08-06
D200600021	01181	14-03	D200600049	01187	08-09
D200600022	01175	14-03	D200600050	01188	09-01
D200600028	01176	10-04	D200600051	01189	07-06
D200600028	01176	10-05	D200600052	01190	21-04
D200600028	01176	10-06	D200600053	01191	21-04
D200600028	01176	12-07	D200600056	01192	25-03
D200600028	01176	14-03	D200600057	01193	25-03
D200600031	01177	06-11	D200600058	01194	25-03
D200600031	01177	06-12	D200600059	01195	21-01
D200600033	01178	11-02	D200600060	01196	25-01
D200600034	01179	15-03	D200600060	01196	25-02
D200600039	01180	19-04	D200600061	01197	21-04
D200600044	01182	14-03	D200600067	01198	14-03
D200600045	01183	14-03	D200600068	01199	14-03
D200600046	01184	14-03	D200600069	01200	12-06
D200600047	01185	14-03			

**AVALDATUD RAHVUSVAHELISE REGISTREERINGU REGISTREERIMISE
OTSUSE TEADETE NUMBRILINE LOEND**

DM/066825	DM/067116	DM/067379	DM/067504	DM/067584	DM/067623
DM/066825	DM/067142	DM/067391	DM/067512	DM/067589	DM/067623
DM/066825	DM/067293	DM/067396	DM/067516	DM/067604	DM/067623
DM/066906	DM/067294	DM/067407	DM/067517	DM/067608	DM/067645
DM/066906	DM/067295	DM/067416	DM/067518	DM/067621	DM/067708
DM/066906	DM/067296	DM/067419	DM/067519	DM/067622	DM/068058
DM/066906	DM/067297	DM/067421	DM/067520	DM/067622	
DM/066910	DM/067349	DM/067426	DM/067521	DM/067622	
DM/066910	DM/067357	DM/067456	DM/067543	DM/067622	
DM/066910	DM/067378	DM/067503	DM/067544	DM/067622	

XIII. TÖÖSTUSDISAINIALASED ÕIGUSAKTID JA MUU INFO

RIIKLIKUS PATENDIVOLNIKE REGISTRIS REGISTREERITUD PATENDIVOLNIKE NIMEKIRI (seisuga 15. juuni 2006)

Register on asutatud 1. septembril 2001. a Vabariigi Valitsuse 7. augusti 2001. a määrusega nr 271 "Riikliku patendivolinike registri asutamine ja registri pidamise põhimäärus" (RT I 2001, 70, 426) patendivoliniku seaduse § 21 alusel (RT I 2001, 27, 151).

TEGEVUSVALDKOND: KAUBAMÄRK, TÖÖSTUSDISAINILAHENDUS JA GEOGRAAFILINE TÄHIS

- | | | | |
|------------------------------|---|-----------------------|--|
| Arno ANIJALG | OÜ USTERVALL
Raekoja plats 16
51004 Tartu
pk 21, 50002 Tartu
telefon: 744 1980
telefaks: 744 1785
e-post: anijalg@ustervall.ee
http://www.ustervall.ee
võõrkeeled: saksa, vene | Juhan HÄMMALOV | OÜ Intels
Riia 11-3
51010 Tartu
telefon: 742 0401
telefaks: 742 0326
e-post: intelses@estpak.ee
võõrkeeled: inglise, saksa, vene |
| Aivo ARULA | Patendibüroo Käosaar & Co OÜ
Tähe 94
50107 Tartu
telefon: 738 3051
telefaks: 738 3055
e-post: info@kaosaar.ee
http://www.kaosaar.ee
võõrkeeled: inglise, vene | Uno JÄÄGER | Inseneribüroo Uneko OÜ
Rüütli 51a, 80010 Pärnu
telefon: 447 1021
telefaks: 447 1001
GSM: 515 1844
e-post: uno@estpak.ee
võõrkeeled: inglise, soome, vene |
| Martina BÖCKLER-LORVI | OÜ LASVET
Suurtüki 4a, 10133 Tallinn
pk 3136, 10505 Tallinn
telefon: 640 6600
telefaks: 640 6604
e-post: lasvet@lasvet.ee
http://www.lasvet.ee
võõrkeeled: inglise, soome | Sirje KAHU | OÜ USTERVALL
Raekoja plats 16
51004 Tartu
pk 21, 50002 Tartu
telefon: 744 1980
telefaks: 744 1785
e-post: skahu@ustervall.ee
http://www.ustervall.ee
võõrkeeled: inglise, vene |
| Indrek EELMETS | OÜ LASVET
Suurtüki 4a, 10133 Tallinn
pk 3136, 10505 Tallinn
telefon: 640 6600
telefaks: 640 6604
e-post: lasvet@lasvet.ee
http://www.lasvet.ee
võõrkeeled: inglise, vene, soome | Lembit KALEV | Patendibüroo ROOSILLA OÜ
Järveotsa tee 39-61
13520 Tallinn
telefon: 657 1722, 657 5381
telefaks: 657 5381
GSM: 511 9951
e-post: roosilla@roosilla.ee
http://www.roosilla.ee
võõrkeeled: inglise, vene |
| Alla HÄMMALOV | OÜ Intels
Riia 11-3
51010 Tartu
telefon: 742 0401
telefaks: 742 0326
e-post: intelses@estpak.ee
võõrkeeled: inglise, poola, vene | Anneli KANG | OÜ Synest
pk 977, 13402 Tallinn
telefon: 660 9786
telefaks: 660 9787
e-post: anneli@synest.ee
võõrkeeled: inglise, saksa, vene, prantsuse, soome, rootsi |

Elle MELLIK	AAA Patendibüroo OÜ Tartu mnt 16 10117 Tallinn pk 3926, 10509 Tallinn telefon: 660 5910, 660 5911 telefaks: 660 5912 e-post: aaa@aaa.ee http://www.aaa.ee võõrkeeled: inglise, vene	Jaak OSTRAT	OÜ LASVET Suurtüki 4a, 10133 Tallinn pk 3136, 10505 Tallinn telefon: 640 6600 telefaks: 640 6604 e-post: lasvet@lasvet.ee http://www.lasvet.ee võõrkeeled: inglise, saksa, soome, vene
Lembit MITT	AAA Patendibüroo OÜ Tartu mnt 16 10117 Tallinn pk 3926, 10509 Tallinn telefon: 660 5910, 660 5911 telefaks: 660 5912 e-post: aaa@aaa.ee http://www.aaa.ee võõrkeeled: inglise, vene	Villu PAVELTS	OÜ LASVET Suurtüki 4a, 10133 Tallinn pk 3136, 10505 Tallinn telefon: 640 6600 telefaks: 640 6604 e-post: lasvet@lasvet.ee http://www.lasvet.ee võõrkeeled: inglise, soome, vene
Ott MOORLAT	OÜ Moorlat & Ko Patendibüroo pk 723, 12902 Tallinn telefon: 655 0450, 654 2844 telefaks: 654 2844 e-post: ott.moorlat@moorlat.ee http://www.moorlat.ee võõrkeeled: inglise, vene	Toom PUNGAS	OÜ Synest pk 977, 13402 Tallinn telefon: 660 9786 telefaks: 660 9787 e-post: toom@synest.ee võõrkeeled: inglise, saksa, soome, vene
Anfia MORNA	Patendibüroo TURVAJA OÜ Liivalaia 22, 10118 Tallinn telefon: 640 3109 telefaks: 640 3105 e-post: morna@turvaja.ee http://www.turvaja.ee võõrkeeled: inglise, vene	Kaie PUUR	Patendibüroo Käosaar & Co OÜ Tähe 94 50107 Tartu telefon: 738 3051 telefaks: 738 3055 e-post: info@kaosaar.ee http://www.kaosaar.ee võõrkeeled: inglise, vene
Tõnu NELSAS	AAA Patendibüroo OÜ Tartu mnt 16 10117 Tallinn pk 3926, 10509 Tallinn telefon: 660 5910, 660 5911 telefaks: 660 5912 e-post: aaa@aaa.ee http://www.aaa.ee võõrkeeled: inglise, vene, soome	Riina PÄRN	OÜ Intels Riia 11-3 51010 Tartu telefon: 742 0401 telefaks: 742 0326 e-post: intelses@estpak.ee võõrkeeled: inglise, vene
Jüri OLT	Patendibüroo Käosaar & Co OÜ Tähe 94, 50107 Tartu telefon: 738 3051 telefaks: 738 3055 e-post: info@kaosaar.ee http://www.kaosaar.ee võõrkeeled: inglise, saksa, soome, vene	Tarmo ROSMAN	Rosman ja Partnerid OÜ pk 652, 12602 Tallinn telefon: 656 1450 telefaks: 656 1450 e-post: tarman@cc.ttu.ee võõrkeeled: saksa, inglise, ungari, vene
		Arvo SALUMÄE	OÜ Amende Patendibüroo Raua 65 10152 Tallinn telefon: 648 6125 telefaks: 641 0174 e-post: amende@hot.ee võõrkeeled: inglise, saksa, soome, vene

Almar SEHVER**AAA Patendibüroo OÜ**

Tartu mnt 16
10117 Tallinn
pk 3926, 10509 Tallinn
telefon: 660 5910, 660 5911
telefaks: 660 5912
e-post: aaa@aaa.ee
http://www.aaa.ee
võõrkeeled: inglise, vene

Olga TREUFELDT**Patendibüroo TURVAJA OÜ**

Liivalaia 22
10118 Tallinn
telefon: 640 3109
telefaks: 640 3105
e-post: olga@turvaja.ee
http://www.turvaja.ee
võõrkeeled: inglise, vene

Harald TEHVER**Patendibüroo TURVAJA OÜ**

Liivalaia 22
10118 Tallinn
telefon: 640 3109
telefaks: 640 3105
e-post: tehver@turvaja.ee
http://www.turvaja.ee
võõrkeeled: inglise, saksa, vene

Enn URGAS**Patendibüroo TURVAJA OÜ**

Liivalaia 22
10118 Tallinn
telefon: 640 3109
telefaks: 640 3105
e-post: urgas@turvaja.ee
http://www.turvaja.ee
võõrkeeled: inglise, vene

Mari TOOMSOO**Patendibüroo Käosaar & Co OÜ**

Peterburi tee 46, 11415 Tallinn
telefon: 637 9484
telefaks: 637 9485
e-post: mari.toomsoo@kaosaar.ee
http://www.kaosaar.ee
võõrkeeled: inglise, soome

Juta-Maris UUSTALU**OÜ Amende Patendibüroo**

Raua 65
10152 Tallinn
telefon: 648 6125
telefaks: 641 0174
e-post: amende@hot.ee
võõrkeeled: inglise, vene

**LIST OF PATENT ATTORNEYS, REGISTERED IN
THE ESTONIAN STATE REGISTER OF PATENT ATTORNEYS**
(by 15 June 2006)

Register is established on September 1st 2001

FIELD OF ACTIVITY: TRADEMARKS, INDUSTRIAL DESIGNS AND GEOGRAPHICAL INDICATIONS

Arno ANIJALG	USTERVALL Ltd. Raekoja plats 16 51004 Tartu, Estonia P.O. Box 21 50002 Tartu, Estonia Phone: +372 744 1980 Fax: +372 744 1785 E-mail: anijalg@ustervall.ee Http://www.ustervall.ee German, Russian, Estonian	Juhan HÄMMALOV	Intels Ltd. Riia Str. 11-3 51010 Tartu, Estonia Phone: +372 742 0401 Fax: +372 742 0326 E-mail: intelses@estpak.ee English, German, Russian, Estonian
Aivo ARULA	Patent Agency Käosaar & Co Tähe Str. 94 50107 Tartu, Estonia Phone: +372 738 3051 Fax: +372 738 3055 E-mail: info@kaosaar.ee Http://www.kaosaar.ee English, Russian, Estonian	Uno JÄÄGER	Inseneribüroo Uneko Ltd. Rüütli 51a 80010 Pärnu, Estonia Phone: +372 447 1021 Fax: +372 447 1001 GSM: +372 515 1844 E-mail: uno@estpak.ee English, Finnish, Russian, Estonian
Martina BÖCKLER-LORVI	Lasvet Ltd. P.O. Box 3136 10505 Tallinn, Estonia Phone: +372 640 6600 Fax: +372 640 6604 E-mail: lasvet@lasvet.ee Http://www.lasvet.ee English, Finnish, Estonian	Sirje KAHU	USTERVALL Ltd. Raekoja plats 16 51004 Tartu, Estonia P.O. Box 21 50002 Tartu, Estonia Phone: +372 744 1980 Fax: +372 744 1785 E-mail: skahu@ustervall.ee Http://www.ustervall.ee English, Russian, Estonian
Indrek EELMETS	Lasvet Ltd. P.O. Box 3136 10505 Tallinn, Estonia Phone: +372 640 6600 Fax: +372 640 6604 E-mail: lasvet@lasvet.ee Http://www.lasvet.ee English, Finnish, Russian, Estonian	Lembit KALEV	Patent Bureau ROOSILLA Ltd. Järveotsa Road 39-61 13520 Tallinn, Estonia Phone: +372 657 1722 +372 657 5381 Fax: +372 657 5381 GSM: +372 511 9951 E-mail: roosilla@roosilla.ee Http://www.roosilla.ee English, Russian, Estonian
Alla HÄMMALOV	Intels Ltd. Riia Str. 11-3 51010 Tartu, Estonia Phone: +372 742 0401 Fax: +372 742 0326 E-mail: intelses@estpak.ee English, Polish, Russian, Estonian	Anneli KANG	Synest Ltd. P.O. Box 977 13402 Tallinn, Estonia Phone: +372 660 9786 Fax: +372 660 9787 E-mail: anneli@synest.ee English, German, Russian, French, Finnish, Swedish, Estonian

- Urmast KAULER** **Patendibüroo TURVAJA OÜ**
Liivalaia 22
10118 Tallinn, Estonia
Phone: +372 640 3109
Fax: +372 640 3105
E-mail: kauler@turvaja.ee
Http://www.turvaja.ee
English, Russian, Finnish,
Estonian
- Urmast KERNU** **AAA Legal Services**
Tartu Road 16
10117 Tallinn, Estonia
P.O. Box 3926
10509 Tallinn, Estonia
Phone: +372 660 5910
+372 660 5911
Fax: +372 660 5912
E-mail: aaa@aaa.ee
Http://www.aaa.ee
English, German, Finnish,
Russian, Estonian
- Marina KESSELMAN** **Kesna Ltd.**
Tedre Str. 77-52
10616 Tallinn, Estonia
Phone: +372 660 8068
Fax: +372 660 8069
E-mail: kesna@kesna.ee
Http://www.kesna.ee
English, German, Russian,
Estonian
- Ljubov KESSELMAN** **Kesna Ltd.**
Tedre Str. 77-52
10616 Tallinn, Estonia
Phone: +372 660 8068
Fax: +372 660 8069
E-mail: kesna@kesna.ee
Http://www.kesna.ee
English, Russian, Estonian
- Heinu KOITEL** **Patent & Trademark Agency
Koitel**
Tartu Road 65
10115 Tallinn, Estonia
P.O. Box 1759
10902 Tallinn, Estonia
Phone: +372 603 3260
Fax: +372 603 3261
E-mail: koitel@koitel.ee
Http://www.koitel.ee
English, Finnish, Russian,
Estonian
- Raivo KOITEL** **Patent & Trademark Agency
Koitel**
Tartu Road 65
10115 Tallinn, Estonia
P.O. Box 1759
10902 Tallinn, Estonia
Phone: +372 603 3260
Fax: +372 603 3261
E-mail: koitel@koitel.ee
Http://www.koitel.ee
English, Finnish, Russian,
Estonian
- Mart Enn KOPPEL** **Patent Bureau Koppel**
Kajaka 4-10
11317 Tallinn, Estonia
Phone: +372 677 4136
Fax: +372 677 4138
E-mail: info@koppelpb.com
Http://www.koppelpb.com
English, Russian, Finnish,
Estonian
- Heinrich KRUPP** **Patendibüroo TURVAJA OÜ**
Liivalaia 22
10118 Tallinn, Estonia
Phone: +372 640 3109
Fax: +372 640 3105
E-mail: turvaja@turvaja.ee
Http://www.turvaja.ee
German, Russian, Estonian
- Jüri KÄOSAAR** **Patent Agency Käosaar & Co**
Tähe Str. 94
50107 Tartu, Estonia
Phone: +372 738 3051
Fax: +372 738 3055
E-mail: info@kaosaar.ee
Http://www.kaosaar.ee
English, Russian, Estonian
- Kalev KÄOSAAR** **Patent Agency Käosaar & Co**
Peterburi Road 46
11415 Tallinn, Estonia
Phone: +372 637 9484
Fax: +372 637 9485
E-mail:
kalev.kaosaar@kaosaar.ee
Http://www.kaosaar.ee
English, Russian, Estonian

- Reet MAASIKAMÄE** **Patent Bureau Kaitsepurus Ltd.**
Mulla Str. 4-3
10611 Tallinn, Estonia
Phone: +372 673 9097
+372 633 2798
Fax: +372 677 4844
E-mail: purus@online.ee
purus@hot.ee
Http://www.hot.ee/purus/
English, Russian, Estonian
- Raivo MATSOO** **RM Hirvela Patent Bureau Ltd**
Saku 15, 11314 Tallinn, Estonia
Phone: +372 614 0816
Fax: +372 614 0818
E-mail: hirvela@hirvela.ee
English, Russian, Estonian
- Elle MELLIK** **AAA Legal Services**
Tartu Road 16
10117 Tallinn, Estonia
P.O. Box 3926
10509 Tallinn, Estonia
Phone: +372 660 5910
+372 660 5911
Fax: +372 660 5912
E-mail: aaa@aaa.ee
Http://www.aaa.ee
English, Russian, Estonian
- Lembit MITT** **AAA Legal Services**
Tartu Road 16
10117 Tallinn, Estonia
P.O. Box 3926
10509 Tallinn, Estonia
Phone: +372 660 5910
+372 660 5911
Fax: +372 660 5912
E-mail: aaa@aaa.ee
Http://www.aaa.ee
English, Russian, Estonian
- Ott MOORLAT** **Moorlat & Co Ltd. Patent Bureau**
P.O. Box 723
12902 Tallinn, Estonia
Phone: +372 655 0450
+372 654 2844
Fax: +372 654 2844
E-mail: ott.moorlat@moorlat.ee
Http://www.moorlat.ee
English, Russian, Estonian
- Anfia MORNA**
- Tõnu NELSAS**
- Patendibüroo TURVAJA OÜ**
Liivalaia 22
10118 Tallinn, Estonia
Phone: +372 640 3109
Fax: +372 640 3105
E-mail: morna@turvaja.ee
Http://www.turvaja.ee
English, Russian, Estonian
- AAA Legal Services**
Tartu Road 16
10117 Tallinn, Estonia
P.O. Box 3926
10509 Tallinn, Estonia
Phone: +372 660 5910
+372 660 5911
Fax: +372 660 5912
E-mail: aaa@aaa.ee
Http://www.aaa.ee
English, Russian, Finnish, Estonian
- Jüri OLT**
- Patent Agency Käosaar & Co**
Tähe Str. 94
50107 Tartu, Estonia
Phone: +372 738 3051
Fax: +372 738 3055
E-mail: info@kaosaar.ee
Http://www.kaosaar.ee
English, German, Finnish, Russian, Estonian
- Jaak OSTRAT**
- Lasvet Ltd.**
P.O. Box 3136
10505 Tallinn, Estonia
Phone: +372 640 6600
Fax: +372 640 6604
E-mail: lasvet@lasvet.ee
Http://www.lasvet.ee
English, German, Finnish, Russian, Estonian
- Villu PAVELTS**
- Lasvet Ltd.**
P.O. Box 3136
10505 Tallinn, Estonia
Phone: +372 640 6600
Fax: +372 640 6604
E-mail: lasvet@lasvet.ee
Http://www.lasvet.ee
English, Finnish, Russian, Estonian
- Toom PUNGAS**
- Synest Ltd.**
P.O. Box 977
13402 Tallinn, Estonia
Phone: +372 660 9786
Fax: +372 660 9787
E-mail: toom@synest.ee
English, German, Finnish, Russian, Estonian

- Kaie PUUR** **Patent Agency Käosaar & Co**
Tähe Str. 94
50107 Tartu, Estonia
Phone: +372 738 3051
Fax: +372 738 3055
E-mail: info@kaosaar.ee
Http://www.kaosaar.ee
English, Russian, Estonian
- Riina PÄRN** **Intels Ltd.**
Riia Str. 11-3
51010 Tartu, Estonia
Phone: +372 742 0401
Fax: +372 742 0326
E-mail: intelses@estpak.ee
English, Russian,
Estonian
- Tarmo ROSMAN** **Rosman and Partners Ltd.**
P.O. Box 652
12602 Tallinn, Estonia
Phone: +372 656 1450
Fax: +372 656 1450
E-mail: tarman@cc.ttu.ee
German, English, Hungarian,
Russian, Estonian
- Arvo SALUMÄE** **AMENDE Patent Agency Ltd.**
Raua 65, 10152 Tallinn, Estonia
Phone: +372 648 6125
Fax: +372 641 0174
E-mail: amende@hot.ee
English, German, Finnish,
Russian, Estonian
- Almar SEHVER** **AAA Legal Services**
Tartu Road 16
10117 Tallinn, Estonia
P.O. Box 3926
10509 Tallinn, Estonia
Phone: +372 660 5910
+372 660 5911
Fax: +372 660 5912
E-mail: aaa@aaa.ee
Http://www.aaa.ee
English, Russian, Estonian
- Harald TEHVER** **Patendibüroo TURVAJA OÜ**
Liivalaia 22
10118 Tallinn, Estonia
Phone: +372 640 3109
Fax: +372 640 3105
E-mail: tehver@turvaja.ee
Http://www.turvaja.ee
English, German, Russian,
Estonian
- Mari TOOMSOO** **Patent Agency Käosaar & Co**
Peterburi Str. 46
11415 Tallinn, Estonia
Phone: +372 637 9484
Fax: +372 637 9485
E-mail: mari.toomsoo@kaosaar.ee
Http://www.kaosaar.ee
English, Finnish, Estonian
- Olga TREUFELDT** **Patendibüroo TURVAJA OÜ**
Liivalaia 22
10118 Tallinn, Estonia
Phone: +372 640 3109
Fax: +372 640 3105
E-mail: olga@turvaja.ee
Http://www.turvaja.ee
English, Russian, Estonian
- Enn URGAS** **Patendibüroo TURVAJA OÜ**
Liivalaia 22
10118 Tallinn, Estonia
Phone: +372 640 3109
Fax: +372 640 3105
E-mail: urgass@turvaja.ee
Http://www.turvaja.ee
English, Russian, Estonian
- Juta-Maris UUSTALU** **AMENDE Patent Agency Ltd.**
Raua 65, 10152 Tallinn, Estonia
Phone: +372 648 6125
Fax: +372 641 0174
E-mail: amende@hot.ee
English, Russian, Estonian