



ISSN 1406-376X

EESTI VABARIIK

T **EESTI**
TÖÖSTUSDISAINI-
LAHENDUSE LEHT



PATENDIAMETI AMETLIK VÄLJAANNE

4
2007
TALLINN



ISSN 1406-376X

EESTI VABARIIK

T **EESTI**
TÖÖSTUSDISAINI-
LAHENDUSE LEHT

**PATENDIAMETI
AMETLIK VÄLJAANNE**

X aastakäik

**Käesolevas numbris
esitatud andmed
loetakse avaldatuks
15. novembril 2007. a.**

4
2007
NOVEMBER
TALLINN

Eesti Tööstusdisainilahenduse Lehte antakse välja tööstusdisaini kaitse seaduse (jõustunud 11.01.1998) alusel.
The Estonian Industrial Design Gazette is the official publication of the Estonian Patent Office.
Published under Industrial Design Protection Law of the Republic of Estonia (coming into force 11 January 1998).
Date of publication of the data presented in this issue - 15 November 2007.

Patendiameti
infoosakond
Toompuiestee 7
15041 Tallinn
Tel 627 7907
Faks 627 7943
E-post Info@epa.ee

The Information Department
of the Estonian Patent Office
Toompuiestee 7
15041 Tallinn, ESTONIA
Phone +372 627 7907
Fax +372 627 7943
E-mail Info@epa.ee

Levitaja

Eesti Patendiraamatukogu
Olevimägi 8/10
10123 Tallinn
Tel 641 1248
Faks 641 1018
E-post patent@patentlib.ee

Distributor

Estonian Patent Library
Olevimägi 8/10
10123 Tallinn, ESTONIA
Phone +372 641 1248
Fax +372 641 1018
E-mail patent@patentlib.ee

SISUKORD

Andmete identifitseerimise rahvusvahelised numberkoodid (INID-koodid)	4
Riikide, teiste ühenduste ja valitsustevaheliste organisatsioonide koodid	5
I. REGISTREERITUD TÖÖSTUSDISAINILAHENDUSED	6
II. RAHVUSVAHELISELT REGISTREERITUD TÖÖSTUSDISAINILAHENDUSED	36
III. REGISTREERINGU KEHTIVUSE PIKENDAMINE	73
IV. TÖÖSTUSDISAINILAHENDUSE ÜLEMINEK	73
V. REGISTREERINGU JAGAMINE	-
VI. MUUD REGISTREERINGU ANDMETE MUUDATUSED	73
VII. REGISTREERINGU ANDMETE PARANDUSED	-
VIII. TÖÖSTUSDISAINILAHENDUSE LITSENTSIDE REGISTREERIMINE	-
IX. TÖÖSTUSDISAINILAHENDUSE PANTIDE REGISTREERIMINE	-
X. TUNNISTUSE DUPLIKAADI VÄLJAANDMINE	-
XI. TÖÖSTUSDISAINILAHENDUSE KUSTUTAMINE REGISTRIST	73
XII. LOENDID	74
Registreeritud tööstusdisainilahenduste süstemaatiline loend	74
Registreeritud tööstusdisainilahenduste registreerimistaotluste numbriline loend	74
Avaldatud rahvusvahelise registreeringu registreerimise otsuse teadete numbriline loend	74
XIII. TÖÖSTUSDISAINIALASED ÕIGUSAKTID JA MUU INFO	75
Riiklikus patendivolinike registris registreeritud patendivolinike nimekiri	75

CONTENTS

Internationally Agreed Numbers for the Identification of Data (INID Codes)	4
List of Codes of States, Other Entities and Intergovernmental Organizations	5
I. REGISTERED INDUSTRIAL DESIGNS	6
II. INTERNATIONALLY REGISTERED INDUSTRIAL DESIGNS	36
III. EXTENSION OF THE REGISTRATION	73
IV. TRANSFER OF INDUSTRIAL DESIGN	73
V. DIVISION OF THE REGISTRATION.	-
VI. OTHER AMENDMENTS TO REGISTRATION DATA	73
VII. CORRECTIONS TO REGISTRATION DATA	-
VIII. REGISTERING OF LICENSES OF INDUSTRIAL DESIGN	-
IX. REGISTERING OF PLEDGES OF INDUSTRIAL DESIGN	-
X. ISSUE OF A COPY OF THE INDUSTRIAL DESIGN CERTIFICATE	-
XI. DELETION OF INDUSTRIAL DESIGN FROM THE REGISTER	73
XII. LISTS	74
Systematic List of Registered Industrial Designs	74
Numerical List of Registration Applications of Registered Industrial Designs	74
Numerical List of Published Notices of Decisions on Registration of the International Registration	74
XIII. LEGAL ACTS AND INFORMATION CONCERNING INDUSTRIAL DESIGNS	75
List of Patent Attorneys, Registered in the Estonian State Register of Patent Attorneys	79

**ANDMETE IDENTIFITSEERIMISE
RAHVUSVAHELISED NUMBERKOODID
(INID-KOODID)
WIPO Standard ST. 80**

**INTERNATIONALLY AGREED NUMBERS FOR
THE IDENTIFICATION OF DATA
(INID CODES)
WIPO Standard ST. 80**

(11) Registreeringu number	(11) Number of the Registration
(15) Registreerimise kuupäev	(15) Date of the Registration
(18) Registreeringu kehtivuse lõppemise kuupäev	(18) Expected expiration date of the registration
(21) Registreerimistaotluse number	(21) Application Number
(22) Registreerimistaotluse esitamise kuupäev	(22) Application Filing Date
(24) Registreeringu kehtivuse alguse kuupäev	(24) Date from which the Industrial Design right has effected
(28) Variantide arv	(28) Number of Industrial Designs included in the application
(30) Prioriteet	(30) Priority
(51) Rahvusvahelise klassifikatsiooni klassi ja alaklassi number	(51) International Classification for Industrial Designs (class and subclass of the Locarno Classification)
(54) Tööstusdisainilahenduse nimetus	(54) Title of the Industrial Design
(55) Tööstusdisainilahenduse reproduktsioon	(55) Reproduction of the Industrial Design
(72) Tööstusdisainilahenduse autor(id)	(72) Author(s) of Industrial Design
(73) Tööstusdisainilahenduse omanik(ud)	(73) Proprietor(s) of Industrial Design
(74) Patendivolinik või ühine esindaja	(74) Patent Attorney or Common Representative

**RIIKIDE, TEISTE ÜHENDUSTE JA VALITSUSTEVAAHELISTE
ORGANISATSIOONIDE KOODID**

AD	Andorra	DZ	Alžeeria	JM	Jamaica	PW	Belau
AE	Araabia	EA	Euraasia	JO	Jordania	PY	Paraguay
	Ühendemiraadid		Patendiorganisat-	JP	Jaapan	QA	Katar
AF	Afganistan		sioon (EAPO)	KE	Kenya	RO	Rumeenia
AG	Antigua ja Barbuda	EC	Ecuador	KG	Kõrgõzstan	RS	Serbia
AI	Anguilla	EE	Eesti	KH	Kambodža	RU	Venemaa
AL	Albaania	EG	Egiptus	KI	Kiribati	RW	Rwanda
AM	Armeenia	EH	Lääne-Sahara	KM	Komoorid	SA	Saudi Araabia
AN	Hollandi Antillid	EM	Siseturu	KN	Saint Kitts ja Nevis	SB	Saalomoni Saared
AO	Angola		Ühtlustamise	KP	Põhja-Korea	SC	Seišellid
AP	Aafrika Regionaalne		Amet (kaubamärgid	KR	Lõuna-Korea	SD	Sudaan
	Tööstusomandi Orga-		ja tööstusdisaini-	KW	Kuveit	SE	Rootsi
	nisatsioon (ARIPO)		lahendused) (OHIM)	KY	Kaimanisaared	SG	Singapur
AR	Argentina	EP	Euroopa	KZ	Kasahstan	SH	Saint Helena
AS	Ameerika Samoa		Patendiamet (EPO)	LA	Laos	SI	Sloveenia
AT	Austria	ER	Eritrea	LB	Liibanon	SK	Slovakkia
AU	Austraalia	ES	Hispaania	LC	Saint Lucia	SL	Sierra Leone
AW	Aruba	ET	Etiopia	LI	Liechtenstein	SM	San Marino
AZ	Aserbaidžaan	FI	Soome	LK	Sri Lanka	SN	Senegal
BA	Bosnia ja	FJ	Fidži	LR	Libeeria	SO	Somaalia
	Hertsegoviina	FK	Falklandi (Malviini)	LS	Lesotho	SR	Suriname
BB	Barbados		saared	LT	Leedu	ST	São Tomé ja Príncipe
BD	Bangladesh	FM	Mikroneesia	LU	Luksemburg	SV	El Salvador
BE	Belgia	FO	Fääri saared	LV	Läti	SY	Süüria
BF	Burkina Faso	FR	Prantsusmaa	LY	Liibüa	SZ	Svaasimaa
BG	Bulgaaria	GA	Gabon	MA	Maroko	TC	Turks ja Caicos
BH	Bahrein	GB	Ühendkuningriik	MC	Monaco	TD	Tšaad
BI	Burundi		(Suurbritannia)	MD	Moldova	TG	Togo
BJ	Benin	GC	Pärsia Lahe	ME	Montenegro	TH	Tai
BM	Bermuda		Koostööõnukogu	MG	Madagaskar	TJ	Tadžikistan
BN	Brunei	GD	Grenada	MH	Marshalli Saared	TM	Türkmenistan
BO	Boliivia	GE	Gruusia	MK	Makedoonia	TN	Tuneesia
BR	Brasiilia	GG	Guernsey	ML	Mali	TO	Tonga
BS	Bahama	GH	Ghana	MM	Myanmar (Birma)	TL	Ida-Timor
BT	Bhutan	GI	Gibraltar	MN	Mongoolia	TR	Türgi
BV	Bouvet' saar	GL	Gröönimaa	MO	Macao	TT	Trinidad ja Tobago
BW	Botswana	GM	Gambia	MP	Põhja-Mariaanid	TV	Tuvalu
BX	Beneluxi	GN	Guinea	MR	Mauritaania	TW	Taiwan (Hiina provints)
	Kaubamärgiamet	GQ	Ekvatoriaal-Guinea	MS	Montserrat	TZ	Tansaania
	(BBM) ja Beneluxi	GR	Kreeka	MT	Malta	UA	Ukraina
	Tööstusdisainilahen-	GS	Lõuna-Georgia ja	MU	Mauritius	UG	Uganda
	duste Amet (BBDM)		Lõuna-Sandwichi	MV	Maldiivid	US	Ameerika
BY	Valgevene		saared	MW	Malawi		Ühendriigid
BZ	Belize	GT	Guatemala	MX	Mehhiko	UY	Uruguay
CA	Kanada	GW	Guinea-Bissau	MY	Malaisia	UZ	Usbekistan
CF	Kesk-Aafrika	GY	Guyana	MZ	Mosambiik	VA	Vatikan (Püha Tool)
	Vabariik	HK	Hongkong	NA	Namiibia	VC	Saint Vincent ja
CG	Kongo	HN	Honduras	NE	Niger		Grenadiinid
CH	Šveits	HR	Horvaatia	NG	Nigeeria	VE	Venezuela
CI	Côte d'Ivoire	HT	Haiti	NI	Nicaragua	VG	Neitsisaared
CK	Cooki saared	HU	Ungari	NL	Holland	VN	Vietnam
CL	Tšiili	IB	Ülemaailmse	NO	Norra	VU	Vanuatu
CM	Kamerun		Intellektuaalomandi	NP	Nepal	WO	Ülemaailmne
CN	Hiina		Organisatsiooni	NR	Nauru		Intellektuaalomandi
CO	Kolumbia		(WIPO) Rahvus-	NZ	Uus-Meremaa		Organisatsioon
CR	Costa Rica		vaheline Büroo	OA	Aafrika Intellektuaal-		(WIPO) (Rahvus-
CU	Kuuba	ID	Indoneesia		omandi Organisat-		vaheline Büroo)
CV	Cabo Verde	IE	Iiri		sioon (OAPI)	WS	Samoa
CY	Küpros	IL	Iisrael	OM	Omaan	YE	Jeemen
CZ	Tšehhi	IM	Man'i saar	PA	Panama	ZA	Lõuna-Aafrika Vabariik
DE	Saksamaa	IN	India	PE	Peruu	ZM	Sambia
DJ	Djibouti	IQ	Iraak	PG	Paapua Uus-Guinea	ZR	Zaire
DK	Taani	IR	Iraan	PH	Filipiinid	ZW	Zimbabwe
DM	Dominica	IS	Island	PK	Pakistan		
DO	Dominikaani	IT	Itaalia	PL	Poola		
	Vabariik	JE	Jersey	PT	Portugal		

I. REGISTREERITUD TÖÖSTUSDISAINILAHENDUSED

Avaldatakse "Tööstusdisaini kaitse seaduse" § 55¹ lõike 7 alusel.

Patendiamet ei ole kontrollinud tööstusdisainilahenduse uudsust ja eristatavust tulenevalt "Tööstusdisaini kaitse seaduse" § 31 lõike 2 punktist 1.

(11) Registreeringu number	01330	(51) Klass: 25-01
(21) Taotluse number	D200700001	
(15) Registreerimise päev	15.11.2007	
(22) Esitamise päev	17.01.2007	
(24) Registreeringu kehtivuse alguse päev	17.01.2007	
(18) Registreeringu kehtivuse lõppemise päev	17.01.2012	
(28) Variantide arv	2	
(72) Autor	Indrek Tuulik, Toome tee 5-11, Loo alevik, 74201 Harju maakond, EE	
(73) Omanik	Indrek Tuulik, Toome tee 5-11, Loo alevik, 74201 Harju maakond, EE	

(54) Nimetus **Ehituskivi**

(55) Reproduktsoon

01330-01



01330-02



- (11) **Registreeringu number** **01331** (51) Klass: **05-06, 09-05**
- (21) **Taotluse number** D200700016
- (15) **Registreerimise päev** 15.11.2007
- (22) **Esitamise päev** 12.03.2007
- (24) **Registreeringu kehtivuse alguse päev** 12.03.2007
- (18) **Registreeringu kehtivuse lõppemise päev** 12.03.2012
- (28) **Variantide arv** 2
- (72) **Autor** Jelena Sandul, Orumetsa 10-4, Maardu, 74111 Harju maakond, EE
- (73) **Omanik** Jelena Sandul, Orumetsa 10-4, Maardu, 74111 Harju maakond, EE
- (54) **Nimetus** **Lillede kilekott**
- (55) **Reproduktsoon**

01331-01

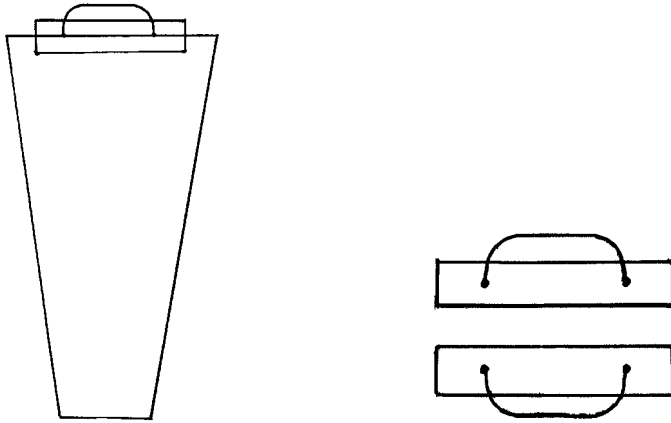

01331-02

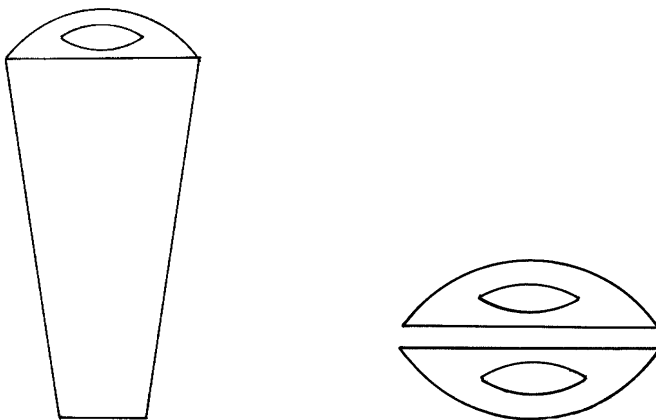

(11) Registreeringu number	01332	(51) Klass: 23-03
(21) Taotluse number	D200700031	
(15) Registreerimise päev	15.11.2007	
(22) Esitamise päev	13.04.2007	
(24) Registreeringu kehtivuse alguse päev	13.04.2007	
(18) Registreeringu kehtivuse lõppemise päev	13.04.2012	
(28) Variantide arv	2	
(72) Autor	Toomas Raidna, Pärnamäe tee 155, Viimsi vald, 74001 Harju maakond, EE	
(73) Omanik	OÜ Visari Metallitööd, Laki 11, 12915 Tallinn, EE	

(54) Nimetus **Puuküttega saunaahi**

(55) Reproduktsoon

01332-01

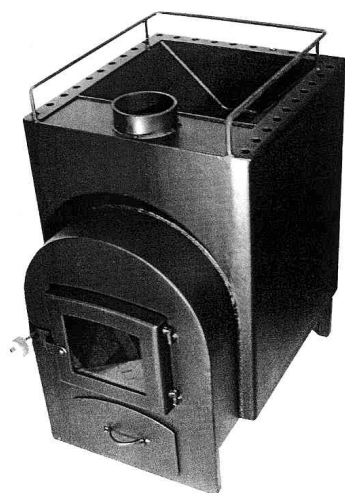

01332-02

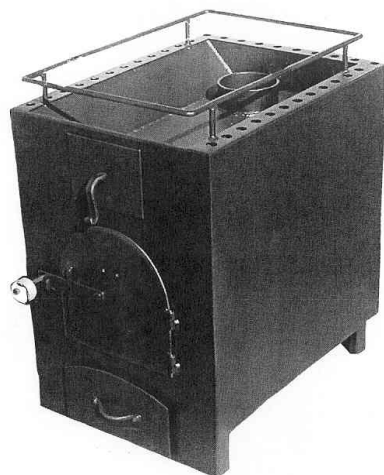

(11) Registreeringu number	01333	(51) Klass: 20-03
(21) Taotluse number	D200700033	
(15) Registreerimise päev	15.11.2007	
(22) Esitamise päev	18.04.2007	
(24) Registreeringu kehtivuse alguse päev	18.04.2007	
(18) Registreeringu kehtivuse lõppemise päev	18.04.2012	
(28) Variantide arv	1	
(72) Autor	Indrek Tamre, Miku talu, Panga küla, Mustjala vald, 93824 Saare maakond, EE	
(73) Omanik	Indrek Tamre, Miku talu, Panga küla, Mustjala vald, 93824 Saare maakond, EE	
(74) Patendivolinik või ühine esindaja	Raivo Koitel	

(54) Nimetus **Ülekäiguraja tähistus**

(55) Reproduktsoon

01333-01

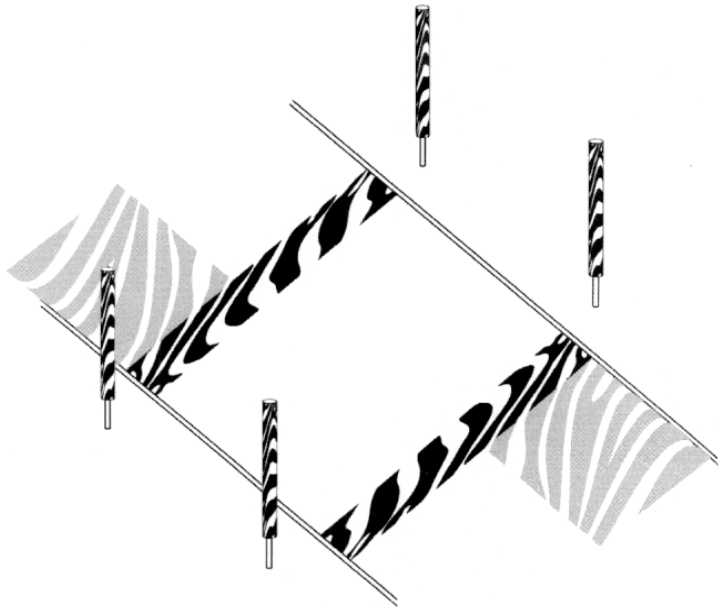

(11) Registreeringu number	01334	(51) Klass: 20-03
(21) Taotluse number	D200700033A	
(15) Registreerimise päev	15.11.2007	
(22) Esitamise päev	18.04.2007	
(24) Registreeringu kehtivuse alguse päev	18.04.2007	
(18) Registreeringu kehtivuse lõppemise päev	18.04.2012	
(28) Variantide arv	4	
(72) Autor	Indrek Tamre, Miku talu, Panga küla, Mustjala vald, 93824 Saare maakond, EE	
(73) Omanik	Indrek Tamre, Miku talu, Panga küla, Mustjala vald, 93824 Saare maakond, EE	
(74) Patendivolinik või ühine esindaja	Raivo Koitel	

(54) Nimetus **Ülekäiguraja tähistus**

(55) Reproduktsoon

01334-01



01334-02



01334-03



01334-04



- (11) **Registreeringu number** **01335** (51) Klass: **12-08**
- (21) **Taotluse number** D200700040
- (15) **Registreerimise päev** 15.11.2007
- (22) **Esitamise päev** 14.05.2007
- (24) **Registreeringu kehtivuse alguse päev** 14.05.2007
- (18) **Registreeringu kehtivuse lõppemise päev** 14.05.2012
- (28) **Variantide arv** 1
- (72) **Autor** Mihhail Partus, Kauba 36, 11312 Tallinn, EE
Vassili Bušujev, Luige 9, Luige küla, Kiili vald, 75501 Harju maakond, EE
- (73) **Omanik** Mihhail Partus, Kauba 36, 11312 Tallinn, EE
Vassili Bušujev, Luige 9, Luige küla, Kiili vald, 75501 Harju maakond, EE
- (54) **Nimetus** **Sõiduauto**
- (55) **Reproduktsoon**
01335-01

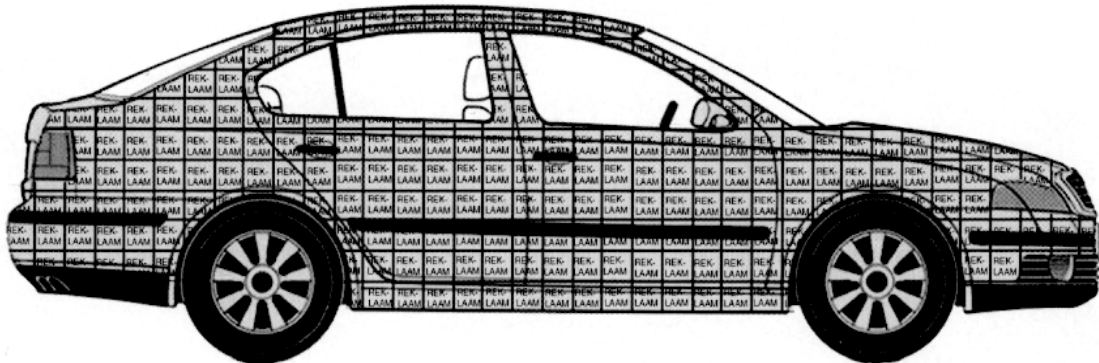
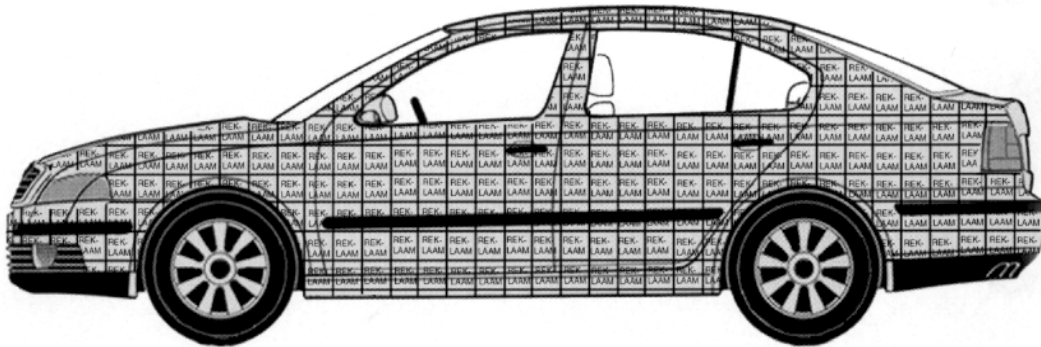

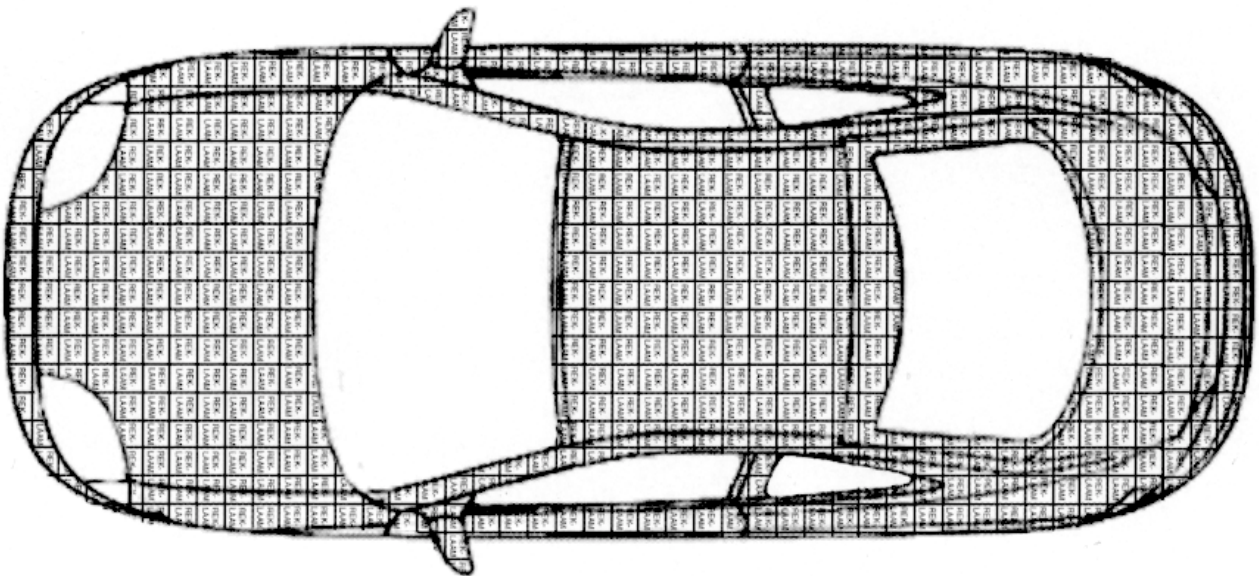
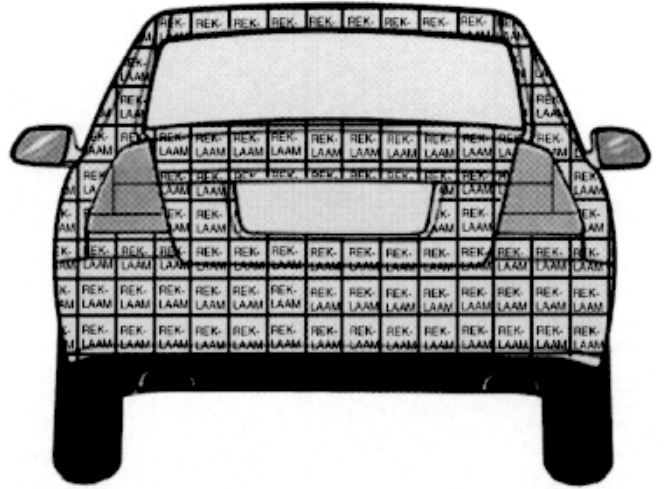
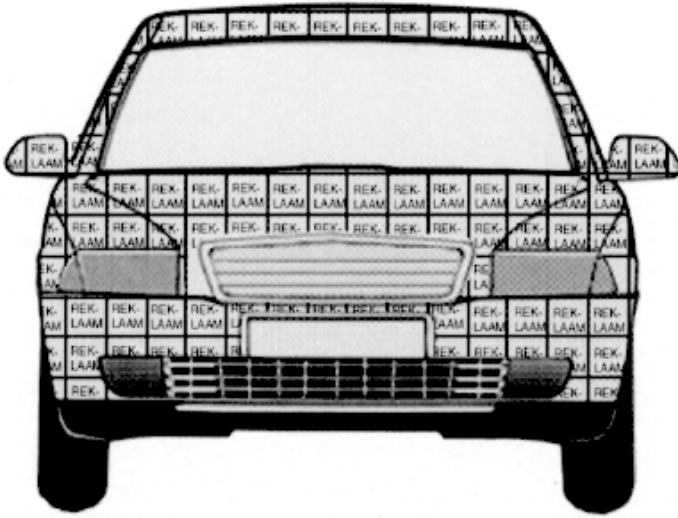

(11) Registreeringu number	01336	(51) Klass: 17-03
(21) Taotluse number	D200700041	
(15) Registreerimise päev	15.11.2007	
(22) Esitamise päev	14.05.2007	
(24) Registreeringu kehtivuse alguse päev	14.05.2007	
(18) Registreeringu kehtivuse lõppemise päev	14.05.2012	
(28) Variantide arv	1	
(72) Autor	Kuldar Kalluste, Siinus 54, Naage küla, Harku vald, 76901 Harju maakond, EE	
(73) Omanik	Kuldar Kalluste, Siinus 54, Naage küla, Harku vald, 76901 Harju maakond, EE	

(54) Nimetus **Kitarr**

(55) Reproduktsoon

01336-01



- (11) **Registreeringu number** **01337** (51) Klass: **14-03**
- (21) **Taotluse number** D200700045
- (15) **Registreerimise päev** 15.11.2007
- (22) **Esitamise päev** 28.05.2007
- (24) **Registreeringu kehtivuse alguse päev** 28.05.2007
- (18) **Registreeringu kehtivuse lõppemise päev** 28.05.2012
- (28) **Variantide arv** 1
- (30) **Prioriteediandmed** M20060221, 28.11.2006, FI
- (72) **Autor** Hang Liu, Jiang Fu Jia Yuan, Bei Li 109-1701, Chaoyang District, Beijing, CN
William Yau, Apartment 612, Building 11, Marriott Palm Springs,
8 Chaoyang Park South Road, ChaoYang District, 100026 Beijing, CN
Antti Kujala, Korkeanmäentie 8 as. 3, 00730 Helsinki, FI
Totti Helin, No. Unit 2003, Tower 8, Seasons Park, No. 36B,
Dongzhimen Wai street, Dongchen District, 100027 Beijing, CN
- (73) **Omanik** Nokia Corporation, Keilalahdentie 4, FIN-02150 Espoo, FI
- (74) **Patendivolinik või ühine esindaja** Jüri Käosaar

(54) **Nimetus** **Käsitelefon**

(55) **Reproduktsoon**

01337-01

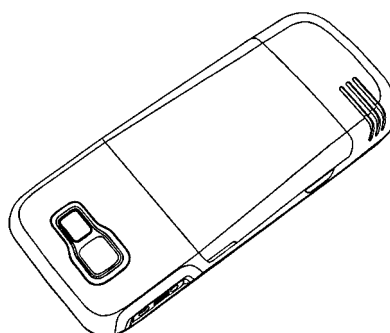
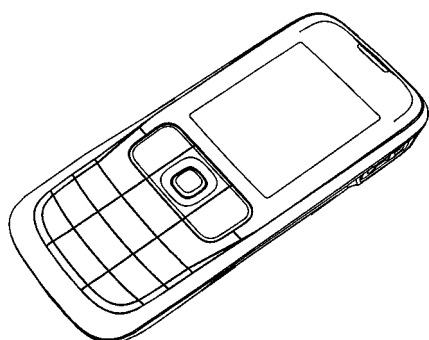
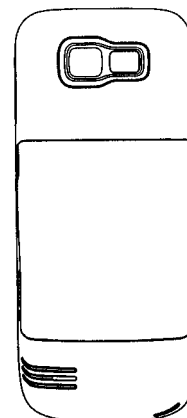
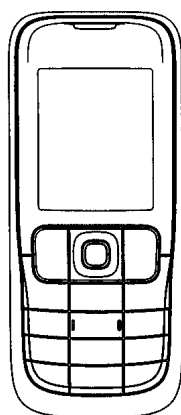

- (11) **Registreeringu number** **01338**
- (21) **Taotluse number** D200700047
- (15) **Registreerimise päev** 15.11.2007
- (22) **Esitamise päev** 28.05.2007
- (24) **Registreeringu kehtivuse alguse päev** 28.05.2007
- (18) **Registreeringu kehtivuse lõppemise päev** 28.05.2012
- (28) **Variantide arv** 1
- (30) **Prioriteediandmed** M20060224, 28.11.2006, FI
- (72) **Autor** Aki Laine, Lersø Parkalle'43, 2 tv., 2100 København Ø, DK
Anton Fahlgren, Nordre Frihavnsgade 28, 2100 Copenhagen, DK
- (73) **Omanik** Nokia Corporation, Keilalahdentie 4, FIN-02150 Espoo, FI
- (74) **Patendivolinik või ühine esindaja** Jüri Käosaar

(51) Klass: 14-03

(54) **Nimetus** **Käsitelefon**(55) **Reproduktsoon**

01338-01

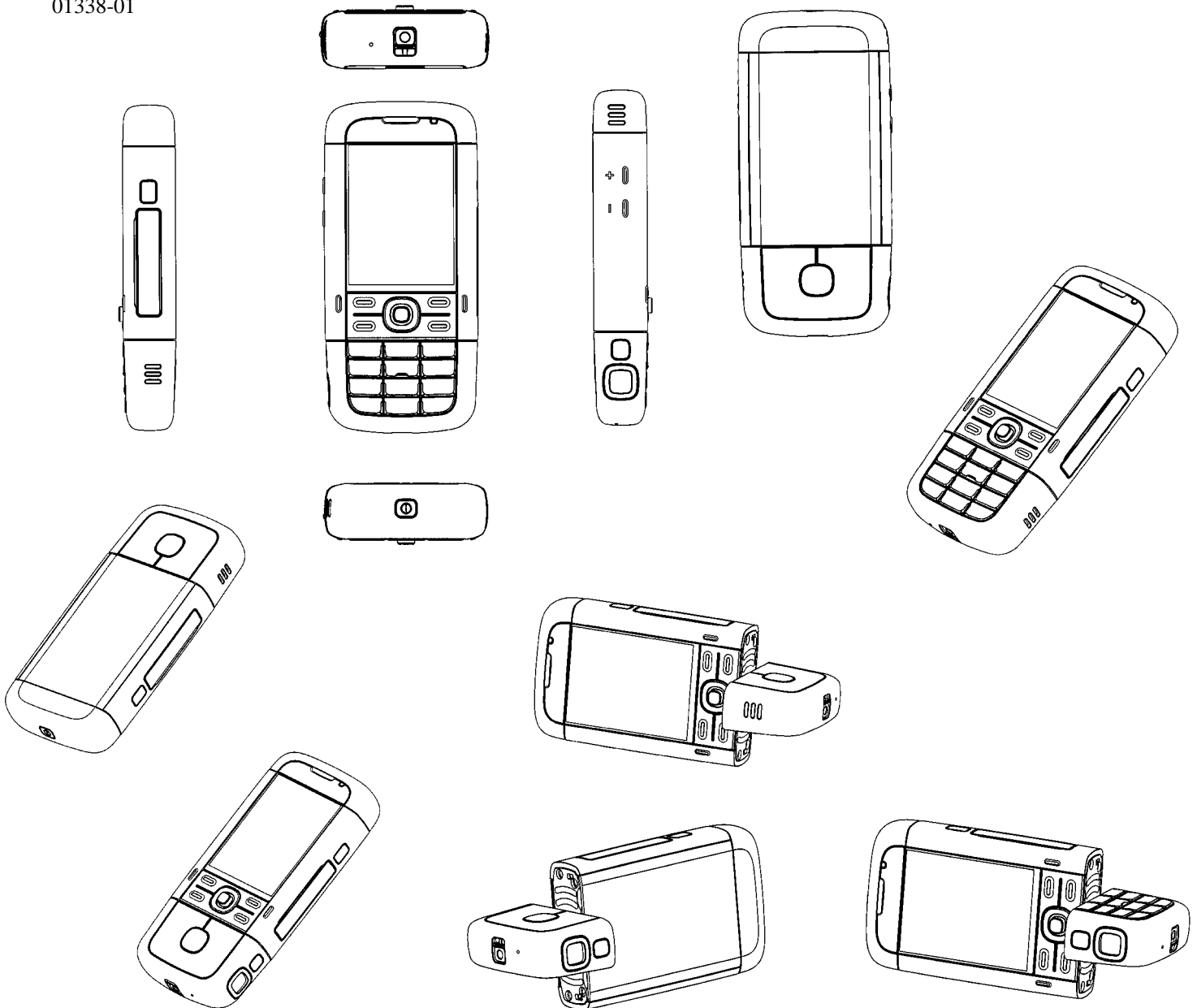

- (11) **Registreeringu number** **01339** (51) Klass: **14-03**
- (21) **Taotluse number** D200700050
- (15) **Registreerimise päev** 15.11.2007
- (22) **Esitamise päev** 28.05.2007
- (24) **Registreeringu kehtivuse alguse päev** 28.05.2007
- (18) **Registreeringu kehtivuse lõppemise päev** 28.05.2012
- (28) **Variantide arv** 1
- (30) **Prioriteediandmed** M20060219, 28.11.2006, FI
- (72) **Autor** Petri Montin, Koskitie 38, 90500 Oulu, FI
Anton Fahlgren, Nordre Frihavnsgrøde 28, 2100 Copenhagen, DK
Aki Laine, Lersø Parkalle'43, 2 tv., 2100 København Ø, DK
Khodi Feiz, Oosterpark 26hs, 1092 AJ Amsterdam, NL
- (73) **Omanik** Nokia Corporation, Keilalahdentie 4, FIN-02150 Espoo, FI
- (74) **Patendivolinik või ühine esindaja** Jüri Käosaar

(54) **Nimetus** **Käsitelefon**

(55) **Reproduktsoon**

01339-01

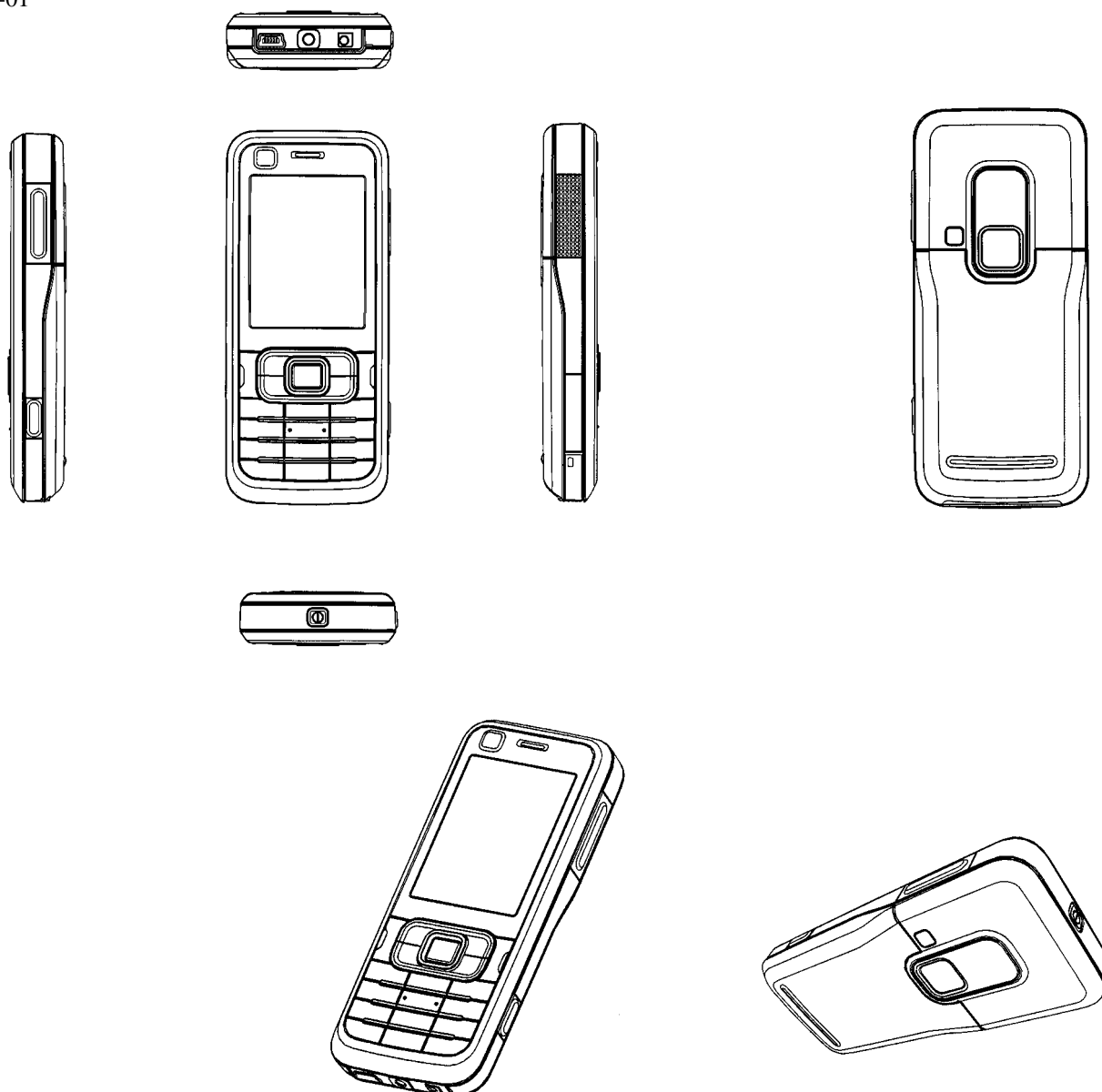

(11) Registreeringu number	01340	(51) Klass: 14-03
(21) Taotluse number	D200700051	
(15) Registreerimise päev	15.11.2007	
(22) Esitamise päev	28.05.2007	
(24) Registreeringu kehtivuse alguse päev	28.05.2007	
(18) Registreeringu kehtivuse lõppemise päev	28.05.2012	
(28) Variantide arv	1	
(30) Prioriteediandmed	M20060220, 28.11.2006, FI	
(72) Autor	Thomas Christiansen, Århusgade 88, 2100 København Ø, DK Anton Fahlgren, Nordre Frihavnsgade 28, 2100 Copenhagen, DK	
(73) Omanik	Nokia Corporation, Keilalahdentie 4, FIN-02150 Espoo, FI	
(74) Patendivolinik või ühine esindaja	Jüri Käosaar	

(54) Nimetus **Käsitelefon**

(55) Reproduktsoon

01340-01

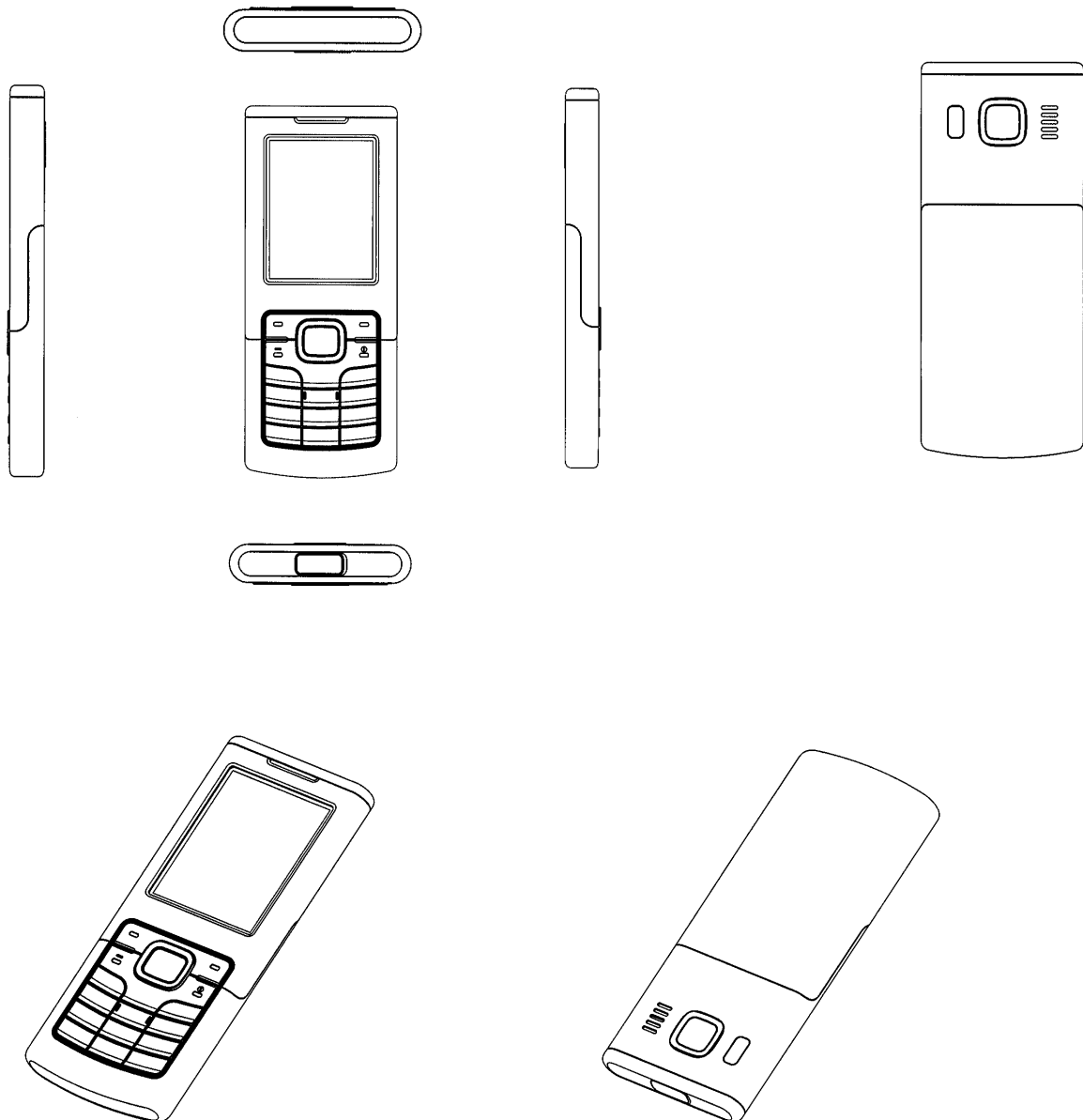

- (11) **Registreeringu number** **01341**
- (21) **Taotluse number** D200700052
- (15) **Registreerimise päev** 15.11.2007
- (22) **Esitamise päev** 28.05.2007
- (24) **Registreeringu kehtivuse alguse päev** 28.05.2007
- (18) **Registreeringu kehtivuse lõppemise päev** 28.05.2012
- (28) **Variantide arv** 1
- (30) **Prioriteediandmed** M20060220, 28.11.2006, FI
- (72) **Autor** Thomas Christiansen, Århusgade 88, 2100 København Ø, DK
Anton Fahlgren, Nordre Frihavnsgade 28, 2100 Copenhagen, DK
- (73) **Omanik** Nokia Corporation, Keilalahdentie 4, FIN-02150 Espoo, FI
- (74) **Patendivolinik või ühine esindaja** Jüri Käosaar

(51) Klass: 14-03

(54) **Nimetus** **Käsitelefon**(55) **Reproduktsoon**

01341-01

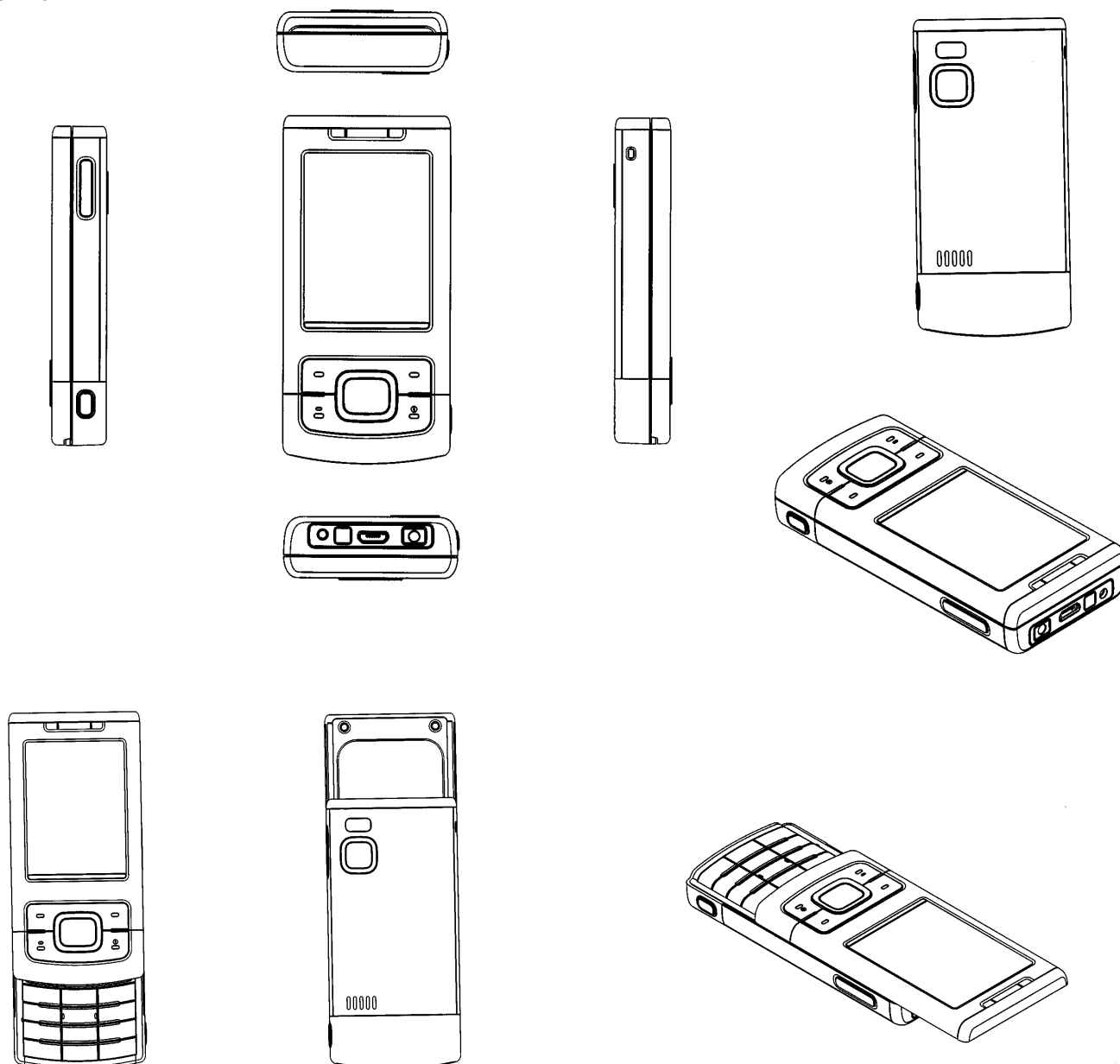

(11) **Registreeringu number** **01342**

(51) Klass: **14-03**

(21) **Taotluse number** D200700053

(15) **Registreerimise päev** 15.11.2007

(22) **Esitamise päev** 28.05.2007

(24) **Registreeringu kehtivuse alguse päev** 28.05.2007

(18) **Registreeringu kehtivuse lõppemise päev** 28.05.2012

(28) **Variantide arv** 1

(30) **Prioriteediandmed** M20060225, 28.11.2006, FI

(72) **Autor** Veikko Rihu, Puolalanpuisto 3a5, 20100 Turku, FI
Valtteri Eroma, Ramsaynranta 1 A 13, 00330 Helsinki, FI

(73) **Omanik** Nokia Corporation, Keilalahdentie 4, FIN-02150 Espoo, FI

(74) **Patendivolinik või ühine esindaja** Jüri Käosaar

(54) **Nimetus** **Käsitelefon**

(55) **Reproduktsoon**

01342-01

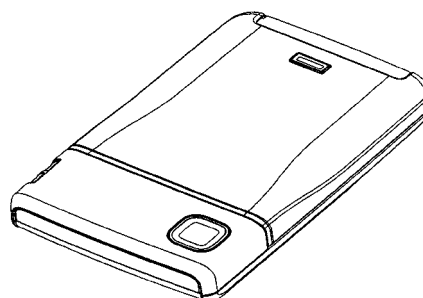
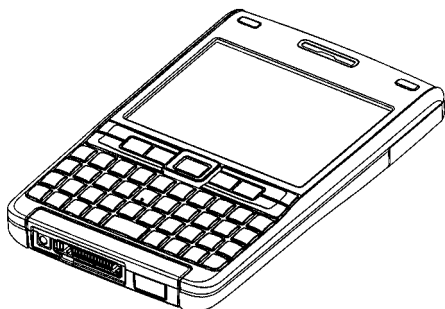
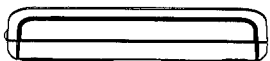
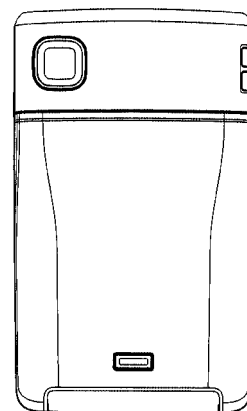
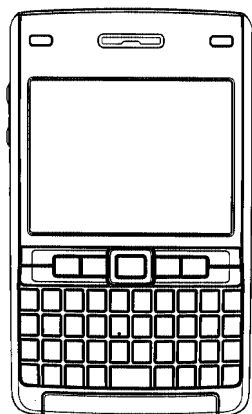

(11) **Registreeringu number** **01343**

(51) Klass: **25-01, 25-02**

(21) **Taotluse number** D200700055

(15) **Registreerimise päev** 15.11.2007

(22) **Esitamise päev** 18.06.2007

(24) **Registreeringu kehtivuse alguse päev** 18.06.2007

(18) **Registreeringu kehtivuse lõppemise päev** 18.06.2012

(28) **Variantide arv** 1

(72) **Autor** Margus Triibmann, Õle 8a, 10611 Tallinn, EE

(73) **Omanik** Roller Leiutised OÜ, Harku tee 3560, Tabasalu, 76901 Harju maakond, EE

(74) **Patendivolinik või ühine esindaja** Jaak Ostrat

(54) **Nimetus** **Metallprofiil**

(55) **Reproduktsoon**

01343-01

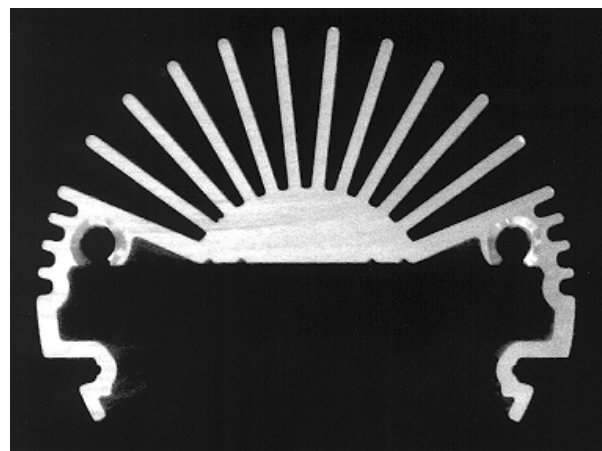
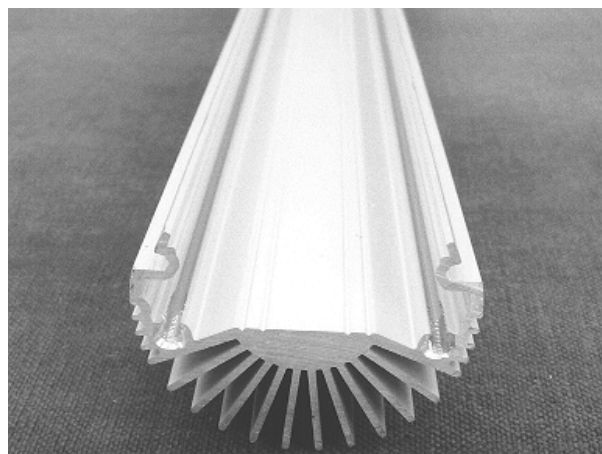

(11) **Registreeringu number** **01344**

(51) Klass: **14-03**

(21) **Taotluse number** D200700057

(15) **Registreerimise päev** 15.11.2007

(22) **Esitamise päev** 11.07.2007

(24) **Registreeringu kehtivuse alguse päev** 11.07.2007

(18) **Registreeringu kehtivuse lõppemise päev** 11.07.2012

(28) **Variantide arv** 1

(30) **Prioriteediandmed** M20070016, 19.01.2007, FI

(72) **Autor** Xiaoxi SHI, Nokia Tower, Pacific Century Place 2A, Gong Ti Bei Lu, Chaoyang District, 100027 Beijing, CN

(73) **Omanik** Nokia Corporation, Keilalahdentie 4, FIN-02150 Espoo, FI

(74) **Patendivolinik või ühine esindaja** Jüri Käosaar

(54) **Nimetus** **Käsitelefon**

(55) **Reproduktsoon**

01344-01

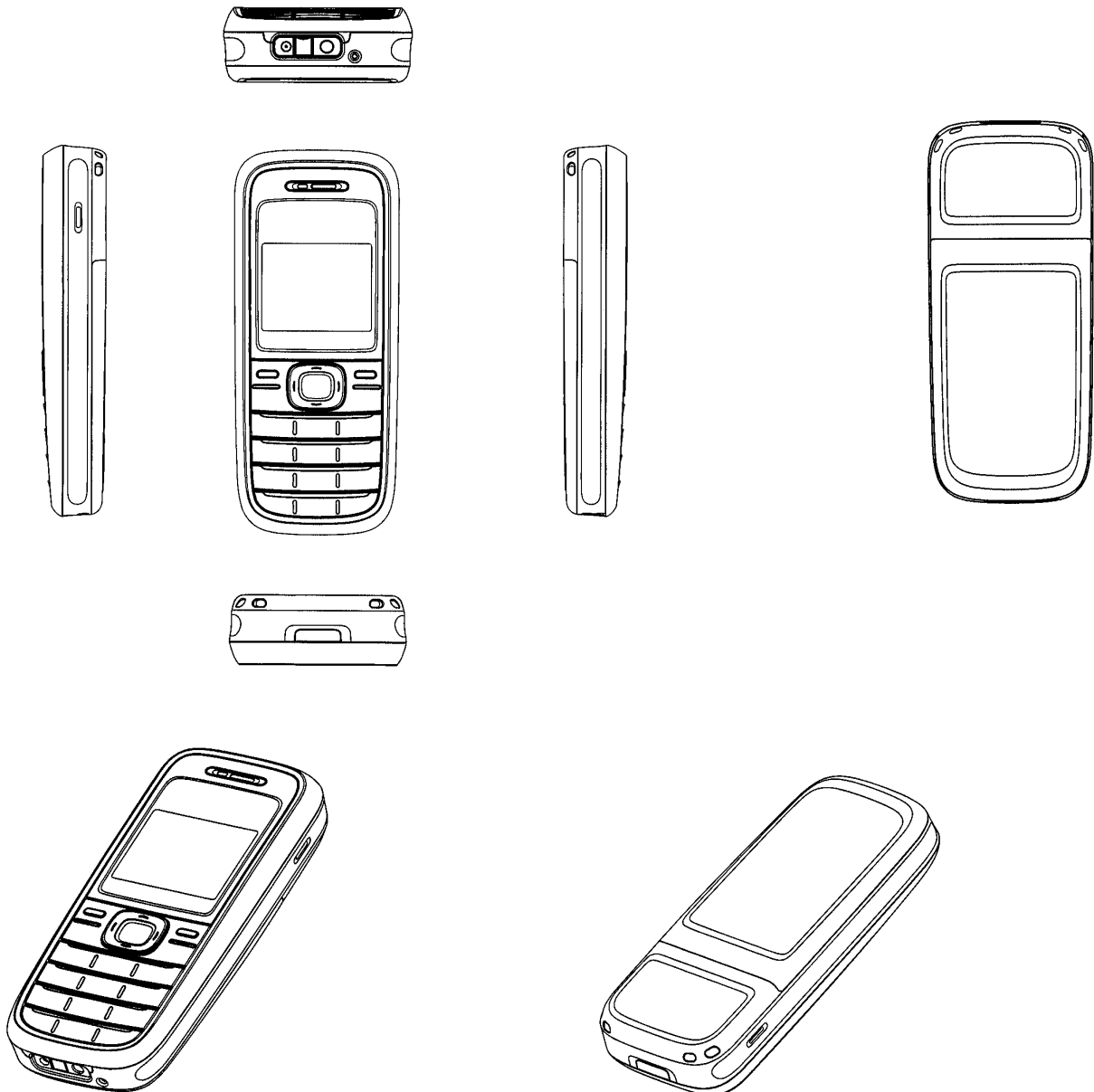

- (11) **Registreeringu number** **01345**
- (21) **Taotluse number** D200700058
- (15) **Registreerimise päev** 15.11.2007
- (22) **Esitamise päev** 11.07.2007
- (24) **Registreeringu kehtivuse alguse päev** 11.07.2007
- (18) **Registreeringu kehtivuse lõppemise päev** 11.07.2012
- (28) **Variantide arv** 1
- (30) **Prioriteediandmed** M20070019, 19.01.2007, FI
- (72) **Autor** Ilkka Husgafvel, Freesenkatu 1 A 9, 00100 Helsinki, FI
- (73) **Omanik** Nokia Corporation, Keilalahdentie 4, FIN-02150 Espoo, FI
- (74) **Patendivolinik või ühine esindaja** Jüri Käosaar

(51) Klass: **14-02, 14-03**

(54) **Nimetus** **Kommunikaator**

(55) **Reproduktsoon**

01345-01

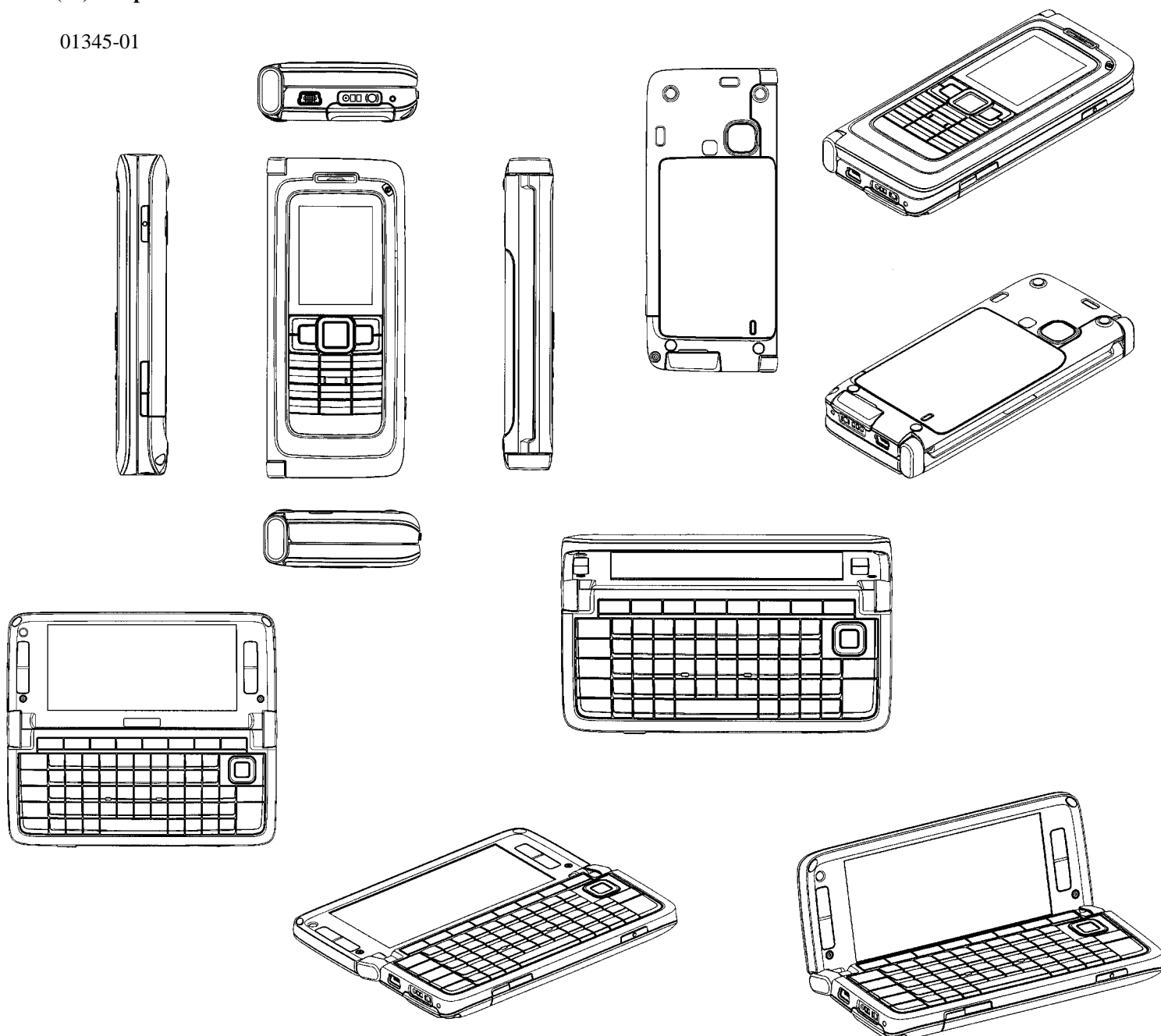

(11) **Registreeringu number** **01346**

(51) Klass: **14-03**

(21) **Taotluse number** D200700059

(15) **Registreerimise päev** 15.11.2007

(22) **Esitamise päev** 11.07.2007

(24) **Registreeringu kehtivuse alguse päev** 11.07.2007

(18) **Registreeringu kehtivuse lõppemise päev** 11.07.2012

(28) **Variantide arv** 1

(30) **Prioriteediandmed** M20070014, 19.01.2007, FI

(72) **Autor** Chun-Wei Su, 5f-2, no. 351, Dun-Hwa Rd, Taichuang, TW

(73) **Omanik** Nokia Corporation, Keilalahdentie 4, FIN-02150 Espoo, FI

(74) **Patendivolinik või ühine esindaja** Jüri Käosaar

(54) **Nimetus** **Käsitelefon**

(55) **Reproduktsoon**

01346-01

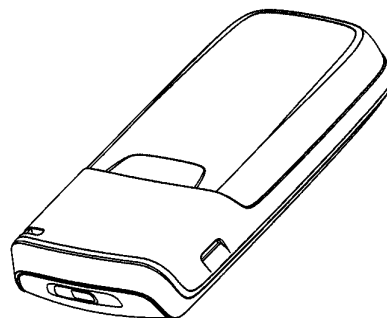
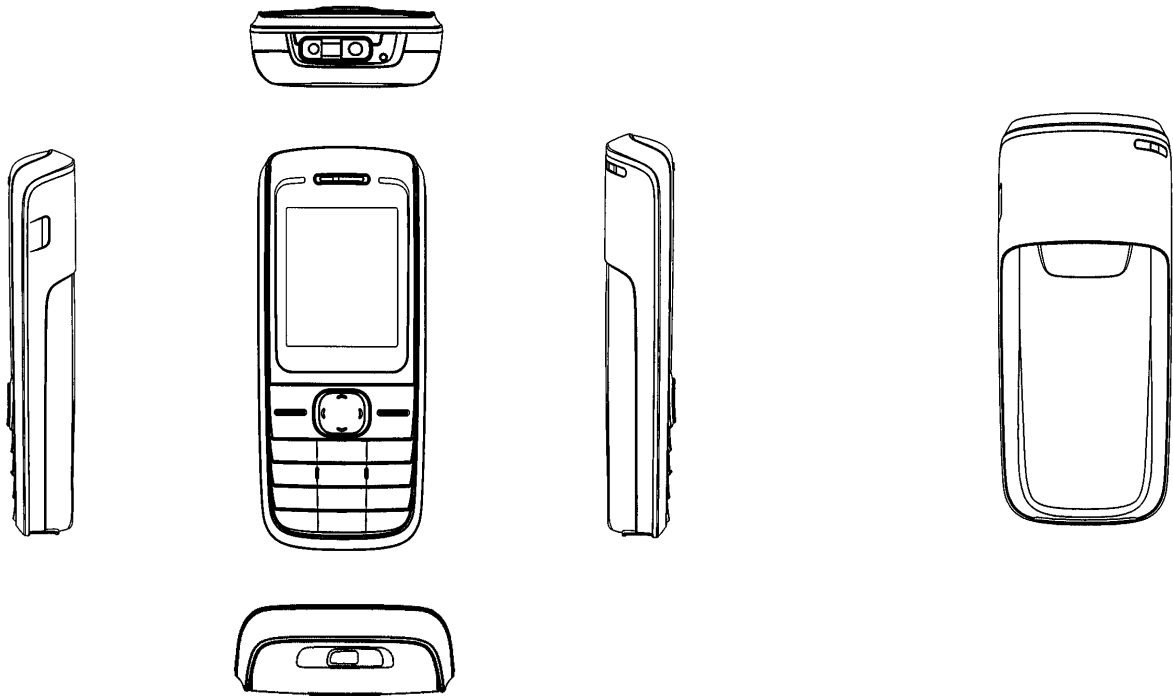

- (11) **Registreeringu number** **01347**
- (21) **Taotluse number** D200700060
- (15) **Registreerimise päev** 15.11.2007
- (22) **Esitamise päev** 11.07.2007
- (24) **Registreeringu kehtivuse alguse päev** 11.07.2007
- (18) **Registreeringu kehtivuse lõppemise päev** 11.07.2012
- (28) **Variantide arv** 1
- (30) **Prioriteediandmed** M20070018, 19.01.2007, FI
- (72) **Autor** Rouger BENOIT, Maariankatu 10B 25, 20100 Turku, FI
- (73) **Omanik** Nokia Corporation, Keilalahdentie 4, FIN-02150 Espoo, FI
- (74) **Patendivolinik või ühine esindaja** Jüri Käosaar

(51) Klass: **14-03**(54) **Nimetus** **Käsitelefon**(55) **Reproduktsoon**

01347-01

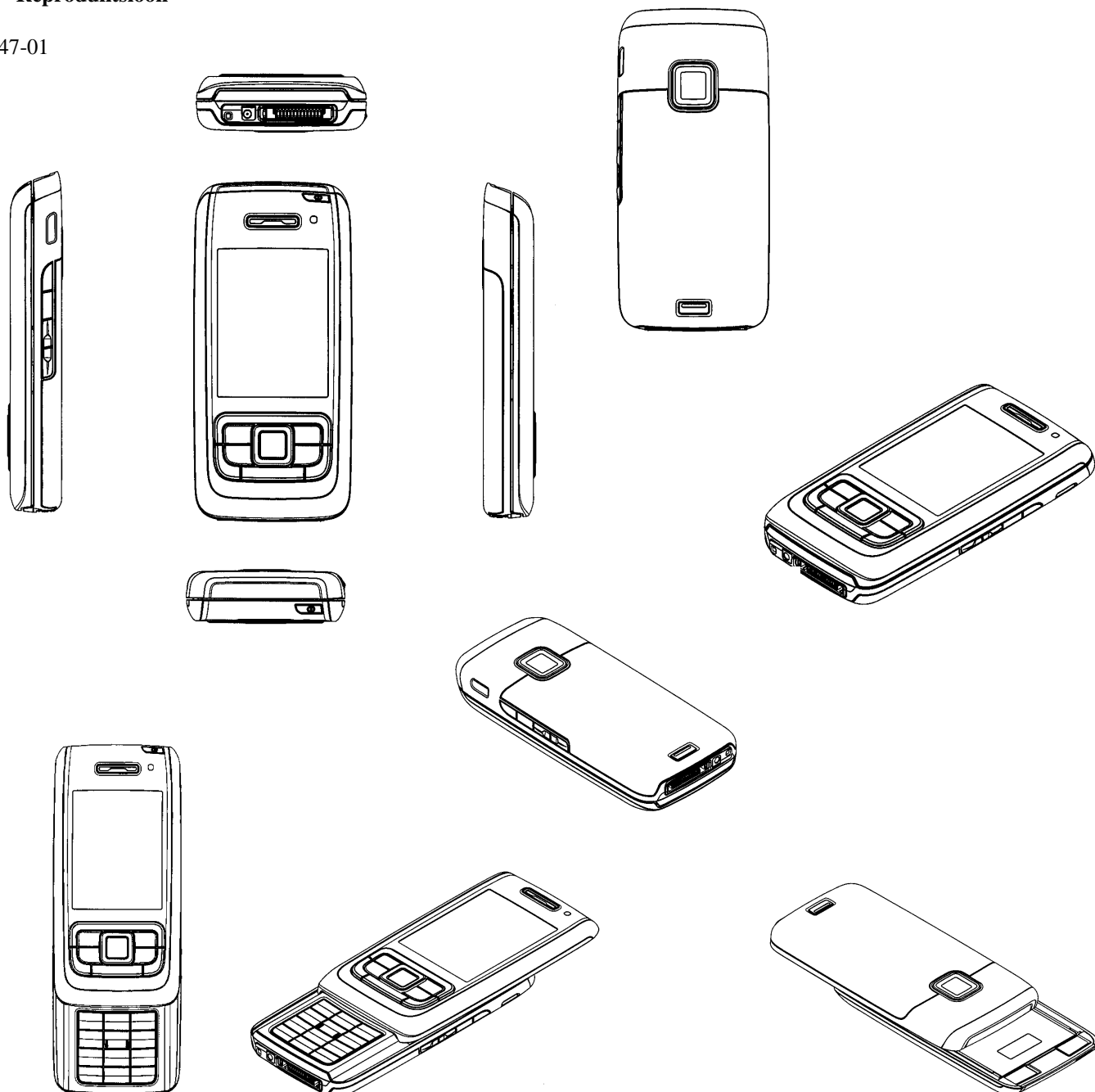

- (11) **Registreeringu number** **01348** (51) Klass: **14-03**
- (21) **Taotluse number** D200700061
- (15) **Registreerimise päev** 15.11.2007
- (22) **Esitamise päev** 11.07.2007
- (24) **Registreeringu kehtivuse alguse päev** 11.07.2007
- (18) **Registreeringu kehtivuse lõppemise päev** 11.07.2012
- (28) **Variantide arv** 1
- (30) **Prioriteediandmed** M20070017, 19.01.2007, FI
- (72) **Autor** Petri Montin, Koskitie 38, 90500 Oulu, FI
Anton Fahlgren, Nordre Frihavnsgrøde 28, 2100 Copenhagen, DK
Khodi Feiz, Oosterpark 26hs, 1092 AJ Amsterdam, NL
- (73) **Omanik** Nokia Corporation, Keilalahdentie 4, FIN-02150 Espoo, FI
- (74) **Patendivolinik või ühine esindaja** Jüri Käosaar

(54) **Nimetus** **Käsitelefon**

(55) **Reproduktsoon**

01348-01

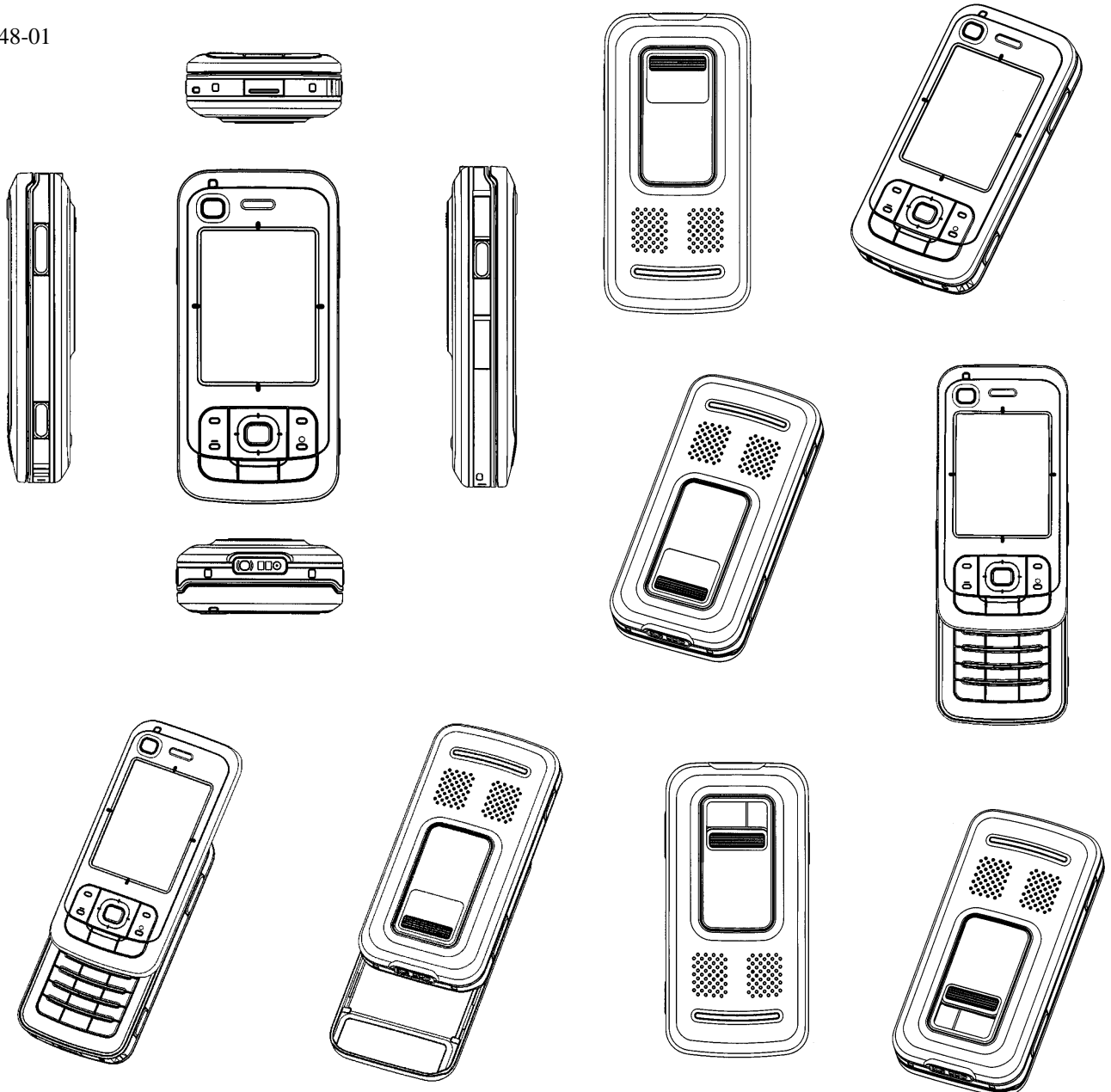

- (11) **Registreeringu number** **01349**
- (21) **Taotluse number** D200700067
- (15) **Registreerimise päev** 15.11.2007
- (22) **Esitamise päev** 03.08.2007
- (24) **Registreeringu kehtivuse alguse päev** 03.08.2007
- (18) **Registreeringu kehtivuse lõppemise päev** 03.08.2012
- (28) **Variantide arv** 2
- (72) **Autor** *Autori andmeid ei avalikustata*
- (73) **Omanik** OÜ RF MAAK, Kuninga 11, 80011 Pärnu, EE

(51) Klass: **25-03**

(54) **Nimetus** **Rannakabiin**

(55) **Reproduktsoon**

01349-01

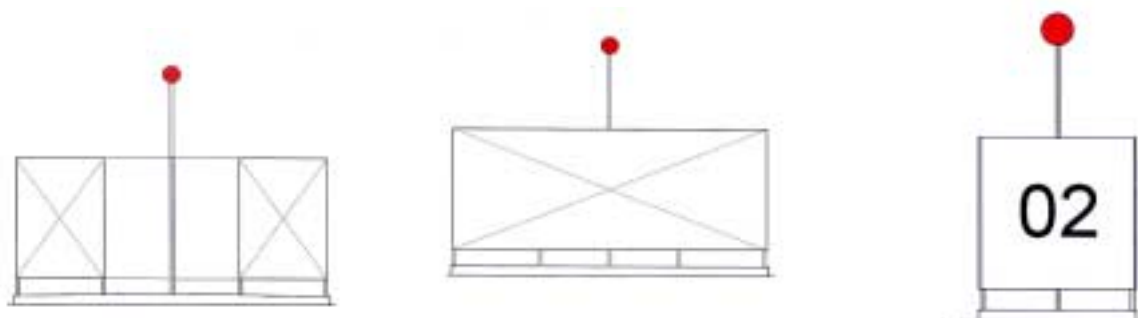

01349-02

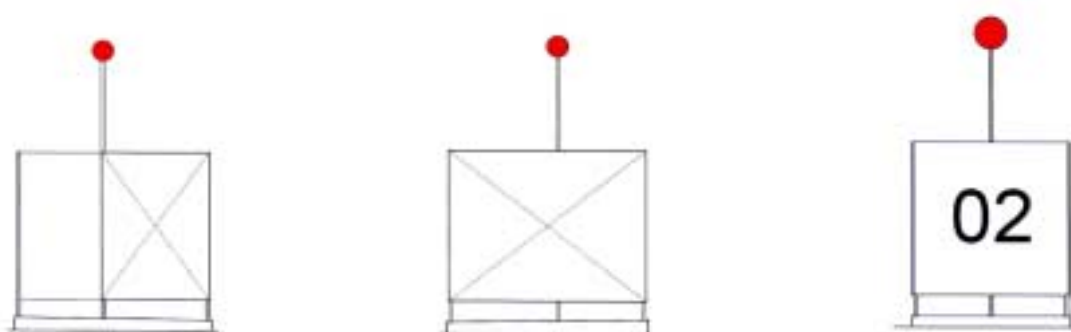

(11) Registreeringu number	01350	(51) Klass: 09-01
(21) Taotluse number	D200700068	
(15) Registreerimise päev	15.11.2007	
(22) Esitamise päev	08.08.2007	
(24) Registreeringu kehtivuse alguse päev	08.08.2007	
(18) Registreeringu kehtivuse lõppemise päev	08.08.2012	
(28) Variantide arv	1	
(30) Prioriteediandmed	2007502393, 16.07.2007, RU	
(72) Autor	AGIRBAS Ahmet Tugrul, Tsvetnoy boulevard 16/1, ap. 27, 103051 Moscow, RU	
(73) Omanik	Zakrytoye aktsionernoye obshchestvo "Moscow-Efes Brewery", Ul. Podolskih kursantov, 15 B, Biryulevo Industrial Zone, 117546 Moscow, RU	
(74) Patendivolinik või ühine esindaja	Olga Treufeldt	

(54) Nimetus **Pudel**

(55) Reproduktsoon

01350-01



- (11) **Registreeringu number** **01351** (51) Klass: **09-03**
- (21) **Taotluse number** D200700074
- (15) **Registreerimise päev** 15.11.2007
- (22) **Esitamise päev** 13.08.2007
- (24) **Registreeringu kehtivuse alguse päev** 13.08.2007
- (18) **Registreeringu kehtivuse lõppemise päev** 13.08.2012
- (28) **Variantide arv** 1
- (72) **Autor** Kärri Jürisson, Liivalaia 40-51, 10145 Tallinn, EE
- (73) **Omanik** AS Balsnack International Holding, Ääsmäe, Saue vald, 76402 Harju maakond, EE
- (74) **Patendivolinik või ühine esindaja** Reet Maasikamäe

(54) **Nimetus** **Karp**

(55) **Reproduktsoon**

01351-01



- (11) **Registreeringu number** **01352** (51) Klass: **09-03**
- (21) **Taotluse number** D200700075
- (15) **Registreerimise päev** 15.11.2007
- (22) **Esitamise päev** 13.08.2007
- (24) **Registreeringu kehtivuse alguse päev** 13.08.2007
- (18) **Registreeringu kehtivuse lõppemise päev** 13.08.2012
- (28) **Variantide arv** 1
- (72) **Autor** Kärri Jürisson, Liivalaia 40-51, 10145 Tallinn, EE
- (73) **Omanik** AS Balsnack International Holding, Ääsmäe, Saue vald, 76402 Harju maakond, EE
- (74) **Patendivolinik või ühine esindaja** Reet Maasikamäe

(54) **Nimetus** **Karp**

(55) **Reproduktsoon**

01352-01



- (11) **Registreeringu number** **01353** (51) Klass: **09-03**
- (21) **Taotluse number** D200700076
- (15) **Registreerimise päev** 15.11.2007
- (22) **Esitamise päev** 13.08.2007
- (24) **Registreeringu kehtivuse alguse päev** 13.08.2007
- (18) **Registreeringu kehtivuse lõppemise päev** 13.08.2012
- (28) **Variantide arv** 1
- (72) **Autor** Tarmo Sepp, Herne 25-8, 10135 Tallinn, EE
Marko Veski, Nõmme tee 106-5, 13418 Tallinn, EE
- (73) **Omanik** AS Balsnack International Holding, Ääsmäe, Saue vald, 76402 Harju maakond, EE
- (74) **Patendivolinik või ühine esindaja** Reet Maasikamäe

(54) **Nimetus** **Karp**

(55) **Reproduktsoon**

01353-01



(11) Registreeringu number	01354	(51) Klass: 09-03
(21) Taotluse number	D200700077	
(15) Registreerimise päev	15.11.2007	
(22) Esitamise päev	13.08.2007	
(24) Registreeringu kehtivuse alguse päev	13.08.2007	
(18) Registreeringu kehtivuse lõppemise päev	13.08.2012	
(28) Variantide arv	1	
(72) Autor	Tarmo Sepp, Herne 25-8, 10135 Tallinn, EE Marko Veski, Nõmme tee 106-5, 13418 Tallinn, EE	
(73) Omanik	AS Balsnack International Holding, Ääsmäe, Saue vald, 76402 Harju maakond, EE	
(74) Patendivolinik või ühine esindaja	Reet Maasikamäe	

(54) Nimetus **Karp**

(55) Reproduktsoon

01354-01



(11) Registreeringu number	01355	(51) Klass: 02-02
(21) Taotluse number	D200700082	
(15) Registreerimise päev	15.11.2007	
(22) Esitamise päev	05.09.2007	
(24) Registreeringu kehtivuse alguse päev	05.09.2007	
(18) Registreeringu kehtivuse lõppemise päev	05.09.2012	
(28) Variantide arv	2	
(72) Autor	Mari Lakspere, Kakumäe tee 257, 13516 Tallinn, EE	
(73) Omanik	Mari Lakspere, Kakumäe tee 257, 13516 Tallinn, EE	

(54) Nimetus **Kampsun**

(55) Reproduktsoon

01355-01



01355-02

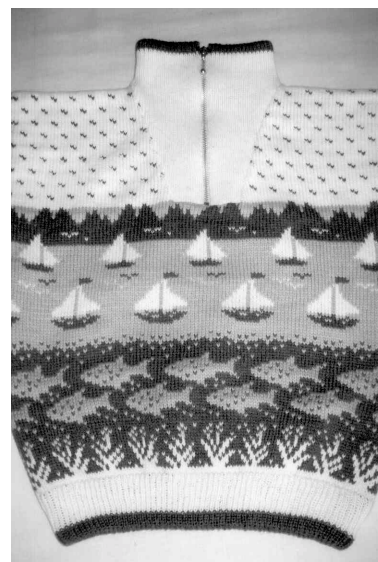

(11) **Registreeringu number** **01356**

(51) Klass: **02-02**

(21) **Taotluse number** D200700083

(15) **Registreerimise päev** 15.11.2007

(22) **Esitamise päev** 05.09.2007

(24) **Registreeringu kehtivuse alguse päev** 05.09.2007

(18) **Registreeringu kehtivuse lõppemise päev** 05.09.2012

(28) **Variantide arv** 2

(72) **Autor** Mari Lakspere, Kakumäe tee 257, 13516 Tallinn, EE

(73) **Omanik** Mari Lakspere, Kakumäe tee 257, 13516 Tallinn, EE

(54) **Nimetus** **Kampsun**

(55) **Reproduktsoon**

01356-01



01356-02

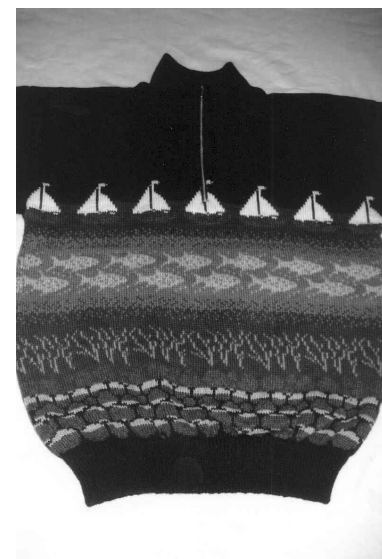

(11) Registreeringu number	01357	(51) Klass: 03-01, 19-06
(21) Taotluse number	D200700084	
(15) Registreerimise päev	15.11.2007	
(22) Esitamise päev	14.09.2007	
(24) Registreeringu kehtivuse alguse päev	14.09.2007	
(18) Registreeringu kehtivuse lõppemise päev	14.09.2012	
(28) Variantide arv	1	
(72) Autor	Lauri Hirvesaar, Mereranna tee 6-11, Haabneeme, 74001 Harju maakond, EE	
(73) Omanik	Lauri Hirvesaar, Mereranna tee 6-11, Haabneeme, 74001 Harju maakond, EE	

(54) Nimetus **Kirjatarvete hoidja harjastega**

(55) Reproduksioon

01357-01



II. RAHVUSVAHELISELT REGISTREERITUD TÖÖSTUSDISAINILAHENDUSED

Avaldatakse "Tööstusdisaini kaitse seaduse" § 87⁴ lõike 3 alusel.

(11) Rahvusvah reg nr	DM/068408	(51) Klass: 10-07
(21) Rahvusvah reg jrk	H200700004	
(15) Registreeringu päev	04.12.2006	
(22) Esitamise päev	04.12.2006	
(28) Variantide arv	1	
(72) Autor	Patrick Joseph Lassigne, 23, chemin des Villarets, 2036 Cormondrèche, CH	
(73) Omanik	PATRICK JOSEPH LASSIGNE, 23, chemin des Villarets, CH-2036 Cormondrèche, CH	

WIPO Rahvusvah Tööstusdisainilahenduste
Bülletääni nr, kus registreering on avaldatud 2006/12

(54) **Nimetus** **Watch case**

(55) **Reproduktsoon**

DM/068408-01



(11) **Rahvusvah reg nr**

DM/068469

(51) Klass: **10-02**(21) **Rahvusvah reg jrk**

H200700007

(15) **Registreeringu päev**

11.01.2007

(22) **Esitamise päev**

11.01.2007

(28) **Variantide arv**

1

(72) **Autor**

Nicolas G. HAYEK, CH-5616 MEISTERSCHWANDEN (AG), CH

(73) **Omanik**

MONTRES BREGUET S.A., CH-1344 L'ABBAYE, CH

WIPO Rahvusvah Tööstusdisainilahenduste**Bülletääni nr, kus registreering on avaldatud** 2007/01(54) **Nimetus**

Watch

(55) **Reproduksioon**

DM/068469-01

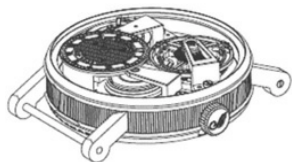
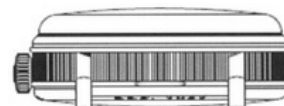

(11) Rahvusvah reg nr	DM/068473	(51) Klass: 10-02
(21) Rahvusvah reg jrk	H200700006	
(15) Registreeringu päev	11.01.2007	
(22) Esitamise päev	11.01.2007	
(28) Variantide arv	1	
(72) Autor	Walter GARRO, SWATCHLAB, Via Archimede 6, I-20129 MILANO, IT	
(73) Omanik	SWATCH AG (SWATCH SA) (SWATCH LTD.), 94, Rue Jakob Stämpfli, CH-2502 BIENNE, CH	
WIPO Rahvusvah Tööstusdisainilahenduste Bülletääni nr, kus registreering on avaldatud	2007/01	

(54) **Nimetus** **Wristwatch**

(55) **Reproduksioon**

DM/068473-01



(11) Rahvusvah reg nr	DM/068562	(51) Klass: 10-02
(21) Rahvusvah reg jrk	H200700009	
(15) Registreeringu päev	08.02.2007	
(22) Esitamise päev	08.02.2007	
(28) Variantide arv	3	
(72) Autor	Arlette Elsa EMCH DUCOMMUN, rue des Mornets 31, CH-2520 LA NEUVEVILLE, CH	
(73) Omanik	THE SWATCH GROUP MANAGEMENT SERVICES AG (THE SWATCH GROUP MANAGEMENT SERVICES SA), (THE SWATCH GROUP MANAGEMENT SERVICES LTD), Seevorstadt 6, CH-2502 Biel/Bienne, CH	

**WIPO Rahvusvah Tööstusdisainilahenduste
Bülletääni nr, kus registreering on avaldatud** 2007/02

(54) **Nimetus** **Wristwatches**

(55) **Reproduksioon**

DM/068562-01



DM/068562-02



DM/068562-03



(11) Rahvusvah reg nr	DM/068562	(51) Klass: 10-02
(21) Rahvusvah reg jrk	H200700009A	
(15) Registreeringu päev	08.02.2007	
(22) Esitamise päev	08.02.2007	
(28) Variantide arv	1	
(72) Autor	Arlette Elsa EMCH DUCOMMUN, rue des Mornets 31, CH-2520 LA NEUVEVILLE, CH	
(73) Omanik	THE SWATCH GROUP MANAGEMENT SERVICES AG (THE SWATCH GROUP MANAGEMENT SERVICES SA), (THE SWATCH GROUP MANAGEMENT SERVICES LTD), Seevorstadt 6, CH-2502 Biel/Bienne, CH	

**WIPO Rahvusvah Tööstusdisainilahenduste
Bülletääni nr, kus registreering on avaldatud** 2007/02

(54) **Nimetus** **Wristwatch**

(55) **Reproduksioon**

DM/068562-01



(11) Rahvusvah reg nr	DM/068562	(51) Klass: 10-02
(21) Rahvusvah reg jrk	H200700009B	
(15) Registreeringu päev	08.02.2007	
(22) Esitamise päev	08.02.2007	
(28) Variantide arv	4	
(72) Autor	Arlette Elsa EMCH DUCOMMUN, rue des Mornets 31, CH-2520 LA NEUVEVILLE, CH	
(73) Omanik	THE SWATCH GROUP MANAGEMENT SERVICES AG (THE SWATCH GROUP MANAGEMENT SERVICES SA), (THE SWATCH GROUP MANAGEMENT SERVICES LTD), Seevorstadt 6, CH-2502 Biel/Bienne, CH	

**WIPO Rahvusvah Tööstusdisainilahenduste
Bülletääni nr, kus registreering on avaldatud** 2007/02

(54) **Nimetus** **Wristwatches**

(55) **Reproduksioon**

DM/068562-01



DM/068562-02



DM/068562-03



DM/068562-04



(11) Rahvusvah reg nr	DM/068562	(51) Klass: 10-02
(21) Rahvusvah reg jrk	H200700009C	
(15) Registreeringu päev	08.02.2007	
(22) Esitamise päev	08.02.2007	
(28) Variantide arv	3	
(72) Autor	Arlette Elsa EMCH DUCOMMUN, rue des Mornets 31, CH-2520 LA NEUVEVILLE, CH	
(73) Omanik	THE SWATCH GROUP MANAGEMENT SERVICES AG (THE SWATCH GROUP MANAGEMENT SERVICES SA), (THE SWATCH GROUP MANAGEMENT SERVICES LTD), Seevorstadt 6, CH-2502 Biel/Bienne, CH	

**WIPO Rahvusvah Tööstusdisainilahenduste
Bülletääni nr, kus registreering on avaldatud** 2007/02

(54) **Nimetus** **Wristwatches**

(55) **Reproduksioon**

DM/068562-01



DM/068562-02



DM/068562-03



(11) Rahvusvah reg nr	DM/068562	(51) Klass: 10-02
(21) Rahvusvah reg jrk	H200700009D	
(15) Registreeringu päev	08.02.2007	
(22) Esitamise päev	08.02.2007	
(28) Variantide arv	2	
(72) Autor	Arlette Elsa EMCH DUCOMMUN, rue des Mornets 31, CH-2520 LA NEUVEVILLE, CH	
(73) Omanik	THE SWATCH GROUP MANAGEMENT SERVICES AG (THE SWATCH GROUP MANAGEMENT SERVICES SA), (THE SWATCH GROUP MANAGEMENT SERVICES LTD), Seevorstadt 6, CH-2502 Biel/Bienne, CH	

**WIPO Rahvusvah Tööstusdisainilahenduste
Bülletääni nr, kus registreering on avaldatud** 2007/02

(54) **Nimetus** **Wristwatches**

(55) **Reproduksioon**

DM/068562-01



DM/068562-02



(11) Rahvusvah reg nr	DM/068563	(51) Klass: 10-02
(21) Rahvusvah reg jrk	H200700010	
(15) Registreeringu päev	08.02.2007	
(22) Esitamise päev	08.02.2007	
(28) Variantide arv	2	
(72) Autor	Arlette Elsa EMCH DUCOMMUN, rue des Mornets 31, CH-2520 LA NEUVEVILLE, CH	
(73) Omanik	THE SWATCH GROUP MANAGEMENT SERVICES AG (THE SWATCH GROUP MANAGEMENT SERVICES SA), (THE SWATCH GROUP MANAGEMENT SERVICES LTD.), Seevorstadt 6, CH-2502 BIENNE, CH	

**WIPO Rahvusvah Tööstusdisainilahenduste
Bülletääni nr, kus registreering on avaldatud** 2007/02

(54) **Nimetus** Watch cases

(55) **Reproduktsoon**

DM/068563-01



DM/068563-02



(11) Rahvusvah reg nr	DM/068575	(51) Klass: 11-01
(21) Rahvusvah reg jrk	H200700011	
(15) Registreeringu päev	21.02.2007	
(22) Esitamise päev	21.02.2007	
(28) Variantide arv	1	
(72) Autor	Arlette Elsa EMCH DUCOMMUN, Rue des Mornets 31, CH-2520 LA NEUVEVILLE, CH	
(73) Omanik	LÉON HATOT SA (LÉON HATOT AG)(LÉON HATOT LTD.), Viaduktstrasse 30, CH-2500 BIEL/BIENNE, CH	
WIPO Rahvusvah Tööstusdisainilahenduste Bülletääni nr, kus registreering on avaldatud	2007/2	

(54) **Nimetus** **Ring (jewelry)**

(55) **Reproduksioon**

DM/068575-01



(11) Rahvusvah reg nr	DM/068594	(51) Klass: 10-02
(21) Rahvusvah reg jrk	H200700012	
(15) Registreeringu päev	15.02.2007	
(22) Esitamise päev	15.02.2007	
(28) Variantide arv	2	
(72) Autor	Arlette Elsa EMCH DUCOMMUN, Rue des Mornets 31, CH-2520 LA NEUVEVILLE, CH	
(73) Omanik	THE SWATCH GROUP MANAGEMENT SERVICES AG (THE SWATCH GROUP MANAGEMENT SERVICES SA), (THE SWATCH GROUP MANGEMENT SERVICES LTD), Seevorstadt 6, BIEL, CH	

**WIPO Rahvusvah Tööstusdisainilahenduste
Bülletääni nr, kus registreering on avaldatud** 2007/02

(54) **Nimetus** **Wristwatches**

(55) **Reproduksioon**

DM/068594-01



DM/068594-02



(11) Rahvusvah reg nr	DM/068594	(51) Klass: 10-02
(21) Rahvusvah reg jrk	H200700012A	
(15) Registreeringu päev	15.02.2007	
(22) Esitamise päev	15.02.2007	
(28) Variantide arv	1	
(72) Autor	Arlette Elsa EMCH DUCOMMUN, Rue des Mornets 31, CH-2520 LA NEUVEVILLE, CH	
(73) Omanik	THE SWATCH GROUP MANAGEMENT SERVICES AG THE SWATCH GROUP MANAGEMENT SERVICES SA), (THE SWATCH GROUP MANGEMENT SERVICES LTD), Seevorstadt 6, BIEL, CH	

**WIPO Rahvusvah Tööstusdisainilahenduste
Bülletääni nr, kus registreering on avaldatud** 2007/02

(54) **Nimetus** **Wristwatch**

(55) **Reproduksioon**

DM/068594-01



(11) Rahvusvah reg nr	DM/068594	(51) Klass: 10-02
(21) Rahvusvah reg jrk	H200700012B	
(15) Registreeringu päev	15.02.2007	
(22) Esitamise päev	15.02.2007	
(28) Variantide arv	2	
(72) Autor	Arlette Elsa EMCH DUCOMMUN, Rue des Mornets 31, CH-2520 LA NEUVEVILLE, CH	
(73) Omanik	THE SWATCH GROUP MANAGEMENT SERVICES AG (THE SWATCH GROUP MANAGEMENT SERVICES SA), (THE SWATCH GROUP MANGEMENT SERVICES LTD), Seevorstadt 6, BIEL, CH	

**WIPO Rahvusvah Tööstusdisainilahenduste
Bülletääni nr, kus registreering on avaldatud** 2007/02

(54) **Nimetus** **Wristwatches**

(55) **Reproduksioon**

DM/068594-01



DM/068594-02



(11) Rahvusvah reg nr	DM/068594	(51) Klass: 10-02
(21) Rahvusvah reg jrk	H200700012C	
(15) Registreeringu päev	15.02.2007	
(22) Esitamise päev	15.02.2007	
(28) Variantide arv	1	
(72) Autor	Arlette Elsa EMCH DUCOMMUN, Rue des Mornets 31, CH-2520 LA NEUVEVILLE, CH	
(73) Omanik	THE SWATCH GROUP MANAGEMENT SERVICES AG (THE SWATCH GROUP MANAGEMENT SERVICES SA), (THE SWATCH GROUP MANGEMENT SERVICES LTD), Seevorstadt 6, BIEL, CH	

**WIPO Rahvusvah Tööstusdisainilahenduste
Bülletääni nr, kus registreering on avaldatud** 2007/02

(54) **Nimetus** **Wristwatch**

(55) **Reproduksioon**

DM/068594-01



(11) Rahvusvah reg nr	DM/068594	(51) Klass: 10-02
(21) Rahvusvah reg jrk	H200700012D	
(15) Registreeringu päev	15.02.2007	
(22) Esitamise päev	15.02.2007	
(28) Variantide arv	1	
(72) Autor	Arlette Elsa EMCH DUCOMMUN, Rue des Mornets 31, CH-2520 LA NEUVEVILLE, CH	
(73) Omanik	THE SWATCH GROUP MANAGEMENT SERVICES AG (THE SWATCH GROUP MANAGEMENT SERVICES SA), THE SWATCH GROUP MANGEMENT SERVICES LTD), Seevorstadt 6, BIEL, CH	

**WIPO Rahvusvah Tööstusdisainilahenduste
Bülletääni nr, kus registreering on avaldatud** 2007/02

(54) **Nimetus** **Wristwatch**

(55) **Reproduksioon**

DM/068594-01



(11) Rahvusvah reg nr	DM/068594	(51) Klass: 10-02
(21) Rahvusvah reg jrk	H200700012E	
(15) Registreeringu päev	15.02.2007	
(22) Esitamise päev	15.02.2007	
(28) Variantide arv	1	
(72) Autor	Arlette Elsa EMCH DUCOMMUN, Rue des Mornets 31, CH-2520 LA NEUVEVILLE, CH	
(73) Omanik	THE SWATCH GROUP MANAGEMENT SERVICES AG (THE SWATCH GROUP MANAGEMENT SERVICES SA), (THE SWATCH GROUP MANGEMENT SERVICES LTD), Seevorstadt 6, BIEL, CH	

**WIPO Rahvusvah Tööstusdisainilahenduste
Bülletääni nr, kus registreering on avaldatud** 2007/02

(54) **Nimetus** **Wristwatch**

(55) **Reproduksioon**

DM/068594-01



(11) Rahvusvah reg nr	DM/068594	(51) Klass: 10-02
(21) Rahvusvah reg jrk	H200700012F	
(15) Registreeringu päev	15.02.2007	
(22) Esitamise päev	15.02.2007	
(28) Variantide arv	1	
(72) Autor	Arlette Elsa EMCH DUCOMMUN, Rue des Mornets 31, CH-2520 LA NEUVEVILLE, CH	
(73) Omanik	THE SWATCH GROUP MANAGEMENT SERVICES AG (THE SWATCH GROUP MANAGEMENT SERVICES SA), (THE SWATCH GROUP MANGEMENT SERVICES LTD), Seevorstadt 6, BIEL, CH	

**WIPO Rahvusvah Tööstusdisainilahenduste
Bülletääni nr, kus registreering on avaldatud** 2007/02

(54) **Nimetus** **Wristwatch**

(55) **Reproduksioon**

DM/068594-01



(11) Rahvusvah reg nr	DM/068609	(51) Klass: 11-01
(21) Rahvusvah reg jrk	H200700013	
(15) Registreeringu päev	31.01.2007	
(22) Esitamise päev	31.01.2007	
(28) Variantide arv	1	
(72) Autor	Arlette Elsa EMCH DUCOMMUN, Rue des Mornets 31, CH-2520 LA NEUVEVILLE, CH	
(73) Omanik	THE SWATCH GROUP MANAGEMENT SERVICES AG (THE SWATCH GROUP MANAGEMENT SERVICES SA), (THE SWATCH GROUP MANAGEMENT SERVICES LTD), Seevorstadt 6, CH-2502 Biel/Bienne, CH	

**WIPO Rahvusvah Tööstusdisainilahenduste
Bülletääni nr, kus registreering on avaldatud** 2007/02

(54) **Nimetus** **Jewellery, including necklace**

(55) **Reproduksioon**

DM/068609-01



(11) Rahvusvah reg nr	DM/068609	(51) Klass: 11-01
(21) Rahvusvah reg jrk	H200700013A	
(15) Registreeringu päev	31.01.2007	
(22) Esitamise päev	31.01.2007	
(28) Variantide arv	1	
(72) Autor	Arlette Elsa EMCH DUCOMMUN, Rue des Mornets 31, CH-2520 LA NEUVEVILLE, CH	
(73) Omanik	THE SWATCH GROUP MANAGEMENT SERVICES AG (THE SWATCH GROUP MANAGEMENT SERVICES SA), (THE SWATCH GROUP MANAGEMENT SERVICES LTD), Seevorstadt 6, CH-2502 Biel/Bienne, CH	

**WIPO Rahvusvah Tööstusdisainilahenduste
Bülletääni nr, kus registreering on avaldatud** 2007/02

(54) **Nimetus** **Jewellery, including necklace**

(55) **Reproduksioon**

DM/068609-01



(11) Rahvusvah reg nr	DM/068609	(51) Klass: 11-01
(21) Rahvusvah reg jrk	H200700013B	
(15) Registreeringu päev	31.01.2007	
(22) Esitamise päev	31.01.2007	
(28) Variantide arv	2	
(72) Autor	Arlette Elsa EMCH DUCOMMUN, Rue des Mornets 31, CH-2520 LA NEUVEVILLE, CH	
(73) Omanik	THE SWATCH GROUP MANAGEMENT SERVICES AG (THE SWATCH GROUP MANAGEMENT SERVICES SA), (THE SWATCH GROUP MANAGEMENT SERVICES LTD), Seevorstadt 6, CH-2502 Biel/Bienne, CH	

**WIPO Rahvusvah Tööstusdisainilahenduste
Bülletääni nr, kus registreering on avaldatud** 2007/02

(54) **Nimetus** **Jewellery, including rings**

(55) **Reproduksioon**

DM/068609-01



DM/068609-02



(11) Rahvusvah reg nr	DM/068609	(51) Klass: 11-01
(21) Rahvusvah reg jrk	H200700013C	
(15) Registreeringu päev	31.01.2007	
(22) Esitamise päev	31.01.2007	
(28) Variantide arv	1	
(72) Autor	Arlette Elsa EMCH DUCOMMUN, Rue des Mornets 31, CH-2520 LA NEUVEVILLE, CH	
(73) Omanik	THE SWATCH GROUP MANAGEMENT SERVICES AG (THE SWATCH GROUP MANAGEMENT SERVICES SA), (THE SWATCH GROUP MANAGEMENT SERVICES LTD), Seevorstadt 6, CH-2502 Biel/Bienne, CH	

**WIPO Rahvusvah Tööstusdisainilahenduste
Bülletääni nr, kus registreering on avaldatud** 2007/02

(54) **Nimetus** **Jewellery, including buckle**

(55) **Reproduktsoon**

DM/068609-01



(11) Rahvusvah reg nr	DM/068609	(51) Klass: 11-01
(21) Rahvusvah reg jrk	H200700013D	
(15) Registreeringu päev	31.01.2007	
(22) Esitamise päev	31.01.2007	
(28) Variantide arv	1	
(72) Autor	Arlette Elsa EMCH DUCOMMUN, Rue des Mornets 31, CH-2520 LA NEUVEVILLE, CH	
(73) Omanik	THE SWATCH GROUP MANAGEMENT SERVICES AG (THE SWATCH GROUP MANAGEMENT SERVICES SA), (THE SWATCH GROUP MANAGEMENT SERVICES LTD), Seevorstadt 6, CH-2502 Biel/Bienne, CH	

**WIPO Rahvusvah Tööstusdisainilahenduste
Bülletääni nr, kus registreering on avaldatud** 2007/02

(54) **Nimetus** **Jewellery, including earrings**

(55) **Reproduktsoon**

DM/068609-01



(11) **Rahvusvah reg nr**

DM/068610

(51) Klass: **10-02**(21) **Rahvusvah reg jrk**

H200700014

(15) **Registreeringu päev**

31.01.2007

(22) **Esitamise päev**

31.01.2007

(28) **Variantide arv**

2

(72) **Autor**Arlette Elsa EMCH DUCOMMUN, Rue des Mornets 31,
CH-2520 LA NEUVEVILLE, CH(73) **Omanik**THE SWATCH GROUP MANAGEMENT SERVICES AG
(THE SWATCH GROUP MANAGEMENT SERVICES SA),
(THE SWATCH GROUP MANAGEMENT SERVICES LTD),
Seevorstadt 6, CH-2502 Biel/Bienne, CH**WIPO Rahvusvah Tööstusdisainilahenduste
Bülletääni nr, kus registreering on avaldatud**

2007/2

(54) **Nimetus****Wristwatches**(55) **Reproduktsoon**

DM/068610-01



DM/068610-02



(11) Rahvusvah reg nr	DM/068630	(51) Klass: 10-02
(21) Rahvusvah reg jrk	H200700021	
(15) Registreeringu päev	07.03.2007	
(22) Esitamise päev	07.03.2007	
(28) Variantide arv	2	
(72) Autor	Arlette Elsa EMCH DUCOMMUN, rue des Mornets 31, CH-2520 LA NEUVEVILLE, CH	
(73) Omanik	THE SWATCH GROUP MANAGEMENT SERVICES AG (THE SWATCH GROUP MANAGEMENT SERVICES SA), (THE SWATCH GROUP MANAGEMENT SERVICES LTD), Seevorstadt 6, CH-2502 Biel/Bienne, CH	

**WIPO Rahvusvah Tööstusdisainilahenduste
Bülletääni nr, kus registreering on avaldatud** 2007/03

(54) **Nimetus** **Wristwatches**

(55) **Reproduksioon**

DM/068630-01



DM/068630-02



(11) Rahvusvah reg nr	DM/068630	(51) Klass: 10-02
(21) Rahvusvah reg jrk	H200700021A	
(15) Registreeringu päev	07.03.2007	
(22) Esitamise päev	07.03.2007	
(28) Variantide arv	1	
(72) Autor	Arlette Elsa EMCH DUCOMMUN, rue des Mornets 31, CH-2520 LA NEUVEVILLE, CH	
(73) Omanik	THE SWATCH GROUP MANAGEMENT SERVICES AG (THE SWATCH GROUP MANAGEMENT SERVICES SA), (THE SWATCH GROUP MANAGEMENT SERVICES LTD), Seevorstadt 6, CH-2502 Biel/Bienne, CH	

**WIPO Rahvusvah Tööstusdisainilahenduste
Bülletääni nr, kus registreering on avaldatud** 2007/03

(54) **Nimetus** **Wristwatch**

(55) **Reproduksioon**

DM/068630-01



(11) Rahvusvah reg nr	DM/068640	(51) Klass: 10-02
(21) Rahvusvah reg jrk	H200700020	
(15) Registreeringu päev	27.02.2007	
(22) Esitamise päev	27.02.2007	
(28) Variantide arv	1	
(72) Autor	Nicole DUPONT, DUPONT DESIGN SA, Route des Jeunes 33, CH-1227 CAROUGE, CH	
(73) Omanik	ETA SA MANUFACTURE HORLOGERE SUISSE, CH-2540 GRENCHEN, CH	

**WIPO Rahvusvah Tööstusdisainilahenduste
Bülletääni nr, kus registreering on avaldatud** 2007/03

(54) **Nimetus** **Wristwatch**

(55) **Reproduksioon**

DM/068640-01



- (11) **Rahvusvah reg nr** **DM/068655** (51) Klass: **10-07**
- (21) **Rahvusvah reg jrk** H200700019
- (15) **Registreeringu päev** 07.03.2007
- (22) **Esitamise päev** 07.03.2007
- (28) **Variantide arv** 1
- (72) **Autor** Adelina BISSOLO, SWATCHLAB, Via Archimede 6,
IT-20129 MILANO, IT
- (73) **Omanik** SWATCH AG (SWATCH SA) (SWATCHLTD.), 94, Rue Jakob Stämpfli,
CH-2502 BIENNE, CH

WIPO Rahvusvah Tööstusdisainilahenduste
Bülletääni nr, kus registreering on avaldatud 2007/03

(54) **Nimetus** **Watch bracelet**

(55) **Reproduksioon**

DM/068655-01



- (11) **Rahvusvah reg nr** **DM/068665** (51) Klass: **99-00**
- (21) **Rahvusvah reg jrk** H200700017
- (15) **Registreeringu päev** 14.02.2007
- (22) **Esitamise päev** 14.02.2007
- (28) **Variantide arv** 3
- (72) **Autor** *Autori andmeid ei avalikustata*
- (73) **Omanik** ESCADA AG, Margaretha-Ley-Ring 1, 85609 Aschheim, DE
- WIPO Rahvusvah Tööstusdisainilahenduste**
Bülletääni nr, kus registreering on avaldatud 2007/03

(54) **Nimetus** **Ornaments of articles**

(55) **Reproduksioon**

DM/068665-01



DM/068665-02



DM/068665-03



(11) Rahvusvah reg nr	DM/068698	(51) Klass: 11-01
(21) Rahvusvah reg jrk	H200700016	
(15) Registreeringu päev	26.03.2007	
(22) Esitamise päev	26.03.2007	
(28) Komplektide arv	1	
(72) Autor	Arlette Elsa EMCH DUCOMMUN, Rue des Mornets 31, CH-2520 LA NEUVEVILLE, CH	
(73) Omanik	THE SWATCH GROUP MANAGEMENT SERVICES AG (THE SWATCH GROUP MANAGEMENT SERVICES SA), (THE SWATCH GROUP MANAGEMENT SERVICES LTD), Seevorstadt 6, CH-2502 Biel/Bienne, CH	

**WIPO Rahvusvah Tööstusdisainilahenduste
Bülletääni nr, kus registreering on avaldatud** 2007/03

(54) **Nimetus** **Jewelry, particularly necklace, bracelet**

(55) **Reproduksioon**

DM/068698-01

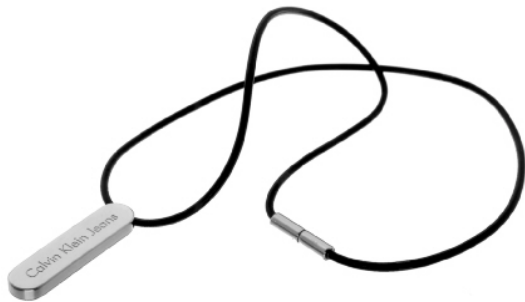

(11) Rahvusvah reg nr	DM/068698	(51) Klass: 11-01
(21) Rahvusvah reg jrk	H200700016A	
(15) Registreeringu päev	26.03.2007	
(22) Esitamise päev	26.03.2007	
(28) Komplektide arv	1	
(72) Autor	Arlette Elsa EMCH DUCOMMUN, Rue des Mornets 31, CH-2520 LA NEUVEVILLE, CH	
(73) Omanik	THE SWATCH GROUP MANAGEMENT SERVICES AG (THE SWATCH GROUP MANAGEMENT SERVICES SA), (THE SWATCH GROUP MANAGEMENT SERVICES LTD), Seevorstadt 6, CH-2502 Biel/Bienne, CH	

**WIPO Rahvusvah Tööstusdisainilahenduste
Bülletääni nr, kus registreering on avaldatud** 2007/03

(54) **Nimetus** **Jewelry, particularly bracelet, ring**

(55) **Reproduksioon**

DM/068698-01



(11) Rahvusvah reg nr	DM/068698	(51) Klass: 11-01
(21) Rahvusvah reg jrk	H200700016B	
(15) Registreeringu päev	26.03.2007	
(22) Esitamise päev	26.03.2007	
(28) Komplektide arv	1	
(72) Autor	Arlette Elsa EMCH DUCOMMUN, Rue des Mornets 31, CH-2520 LA NEUVEVILLE, CH	
(73) Omanik	THE SWATCH GROUP MANAGEMENT SERVICES AG (THE SWATCH GROUP MANAGEMENT SERVICES SA), (THE SWATCH GROUP MANAGEMENT SERVICES LTD), Seevorstadt 6, CH-2502 Biel/Bienne, CH	

**WIPO Rahvusvah Tööstusdisainilahenduste
Bülletääni nr, kus registreering on avaldatud** 2007/03

(54) **Nimetus** **Jewelry, particularly bracelets, ring**

(55) **Reproduksioon**

DM/068698-01



(11) Rahvusvah reg nr	DM/068698	(51) Klass: 11-01
(21) Rahvusvah reg jrk	H200700016C	
(15) Registreeringu päev	26.03.2007	
(22) Esitamise päev	26.03.2007	
(28) Komplektide arv	1	
(72) Autor	Arlette Elsa EMCH DUCOMMUN, Rue des Mornets 31, CH-2520 LA NEUVEVILLE, CH	
(73) Omanik	THE SWATCH GROUP MANAGEMENT SERVICES AG (THE SWATCH GROUP MANAGEMENT SERVICES SA), (THE SWATCH GROUP MANAGEMENT SERVICES LTD), Seevorstadt 6, CH-2502 Biel/Bienne, CH	

**WIPO Rahvusvah Tööstusdisainilahenduste
Bülletääni nr, kus registreering on avaldatud** 2007/03

(54) **Nimetus** **Jewelry, particularly bracelets, ring**

(55) **Reproduksioon**

DM/068698-01



(11) Rahvusvah reg nr	DM/068698	(51) Klass: 11-01
(21) Rahvusvah reg jrk	H200700016D	
(15) Registreeringu päev	26.03.2007	
(22) Esitamise päev	26.03.2007	
(28) Variantide arv	2	
(72) Autor	Arlette Elsa EMCH DUCOMMUN, Rue des Mornets 31, CH-2520 LA NEUVEVILLE, CH	
(73) Omanik	THE SWATCH GROUP MANAGEMENT SERVICES AG (THE SWATCH GROUP MANAGEMENT SERVICES SA), (THE SWATCH GROUP MANAGEMENT SERVICES LTD), Seevorstadt 6, CH-2502 Biel/Bienne, CH	

**WIPO Rahvusvah Tööstusdisainilahenduste
Bülletääni nr, kus registreering on avaldatud** 2007/03

(54) **Nimetus** **Jewelry, particularly rings**

(55) **Reproduksioon**

DM/068698-01



DM/068698-02



(11) Rahvusvah reg nr	DM/068698	(51) Klass: 11-01
(21) Rahvusvah reg jrk	H200700016E	
(15) Registreeringu päev	26.03.2007	
(22) Esitamise päev	26.03.2007	
(28) Variantide arv	1	
(72) Autor	Arlette Elsa EMCH DUCOMMUN, Rue des Mornets 31, CH-2520 LA NEUVEVILLE, CH	
(73) Omanik	THE SWATCH GROUP MANAGEMENT SERVICES AG (THE SWATCH GROUP MANAGEMENT SERVICES SA), (THE SWATCH GROUP MANAGEMENT SERVICES LTD), Seevorstadt 6, CH-2502 Biel/Bienne, CH	
WIPO Rahvusvah Tööstusdisainilahenduste Bülletääni nr, kus registreering on avaldatud	2007/03	

(54) **Nimetus** **Jewelry, particularly ring**

(55) **Reproduksioon**

DM/068698-01



(11) Rahvusvah reg nr	DM/068698	(51) Klass: 11-01
(21) Rahvusvah reg jrk	H200700016F	
(15) Registreeringu päev	26.03.2007	
(22) Esitamise päev	26.03.2007	
(28) Komplektide arv	1	
(72) Autor	Arlette Elsa EMCH DUCOMMUN, Rue des Mornets 31, CH-2520 LA NEUVEVILLE, CH	
(73) Omanik	THE SWATCH GROUP MANAGEMENT SERVICES AG (THE SWATCH GROUP MANAGEMENT SERVICES SA), (THE SWATCH GROUP MANAGEMENT SERVICES LTD), Seevorstadt 6, CH-2502 Biel/Bienne, CH	

**WIPO Rahvusvah Tööstusdisainilahenduste
Bülletääni nr, kus registreering on avaldatud** 2007/03

(54) **Nimetus** **Jewelry, particularly necklace, bracelet**
(55) **Reproduksioon**

DM/068698-01

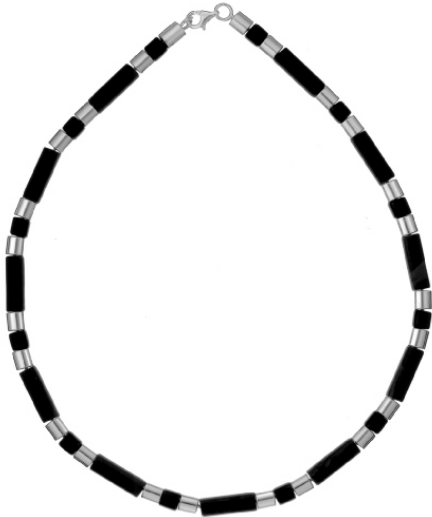

(11) Rahvusvah reg nr	DM/068730	(51) Klass: 10-07
(21) Rahvusvah reg jrk	H200700015	
(15) Registreeringu päev	26.02.2007	
(22) Esitamise päev	20.11.2006	
(28) Variantide arv	1	
(72) Autor	Marcello Binda, Via Ponte Vetere, 1, I-20121 Milan, IT	
(73) Omanik	MONTRES WYLER SA GENÈVE, Boulevard James-Fazy 4, CH-1211 Genève, CH	

**WIPO Rahvusvah Tööstusdisainilahenduste
Bülletääni nr, kus registreering on avaldatud** 2007/03

(54) **Nimetus** **Watch dial**

(55) **Reproduksioon**

DM/068730-01



(11) **Rahvusvah reg nr****DM/068730**(51) Klass: **10-07**(21) **Rahvusvah reg jrk**

H200700015A

(15) **Registreeringu päev**

26.02.2007

(22) **Esitamise päev**

20.11.2006

(28) **Variantide arv**

2

(72) **Autor**

Marcello Binda, Via Ponte Vetere, 1, I-20121 Milan, IT

(73) **Omanik**MONTRES WYLER SA GENÈVE, Boulevard James-Fazy 4,
CH-1211 Genève, CH**WIPO Rahvusvah Tööstusdisainilahenduste
Bülletääni nr, kus registreering on avaldatud**

2007/03

(54) **Nimetus****Watch cases**(55) **Reproduksioon**

DM/068730-01

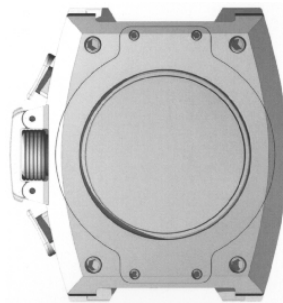

DM/068730-02

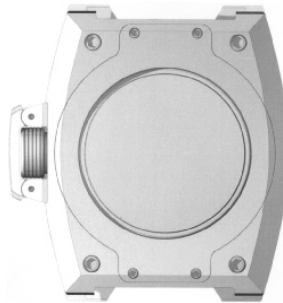

III. REGISTREERINGU KEHTIVUSE PIKENDAMINE

(11)	(18)				
00684	29.07.2012	00700	05.09.2012	00725	11.09.2012
00686	31.07.2012	00702	11.09.2012	00729	20.11.2012
00694	05.09.2012	00703	11.09.2012	00731	25.11.2012
00695	05.09.2012	00704	11.09.2012	00768	23.12.2012
00696	05.09.2012	00711	26.09.2012	00769	23.12.2012
00697	05.09.2012	00716	21.10.2012	00770	23.12.2012
00698	05.09.2012	00722	01.11.2012	00771	23.12.2012
00699	05.09.2012	00724	11.09.2012	00772	23.12.2012

IV. TÖÖSTUSDISAINILAHENDUSE ÜLEMINEK

Reg nr	Uue omaniku andmed	Registrikande jõustumise päev
01329	Einar Luha, Soo 30-20, 10414 Tallinn, EE	21.08.2007

VI. MUUD REGISTREERINGU ANDMETE MUUDATUSED

Reg nr	Muudetud andmed	Registrikande jõustumise päev
00647	(73) V&S Vin & Sprit Aktiebolag (publ), SE-117 97 Stockholm, SE (74) Urmas Kauler, Patendibüroo TURVAJA OÜ, Liivalaia 22, 10118 Tallinn, EE	28.08.2007
00684	(73) JCDecaux Eesti OÜ, Tartu mnt 18, 10115 Tallinn, EE (72) Ulla Mets, Tartu mnt 18, 10115 Tallinn, EE	29.08.2007
00711	(73) RAKETT OÜ, Tõnismägi 3-10, 10119 Tallinn, EE (72) Priit Isok, Tõnismägi 3-10, 10119 Tallinn, EE	28.08.2007

XI. TÖÖSTUSDISAINILAHENDUSE KUSTUTAMINE REGISTRIST

"Tööstusdisaini kaitse seaduse" paragrahvi 77 lõike 1 alusel on registrist kustutatud järgmised tööstusdisainilahendused:

Reg nr	Kustutamise jõustumise päev
00612	05.02.2007
00614	15.02.2007
00621	13.02.2007
00643	26.04.2007
00673	12.04.2007

XII. LOENDID**REGISTREERITUD TÖÖSTUSDISAINILAHENDUSTE SÜSTEMAATILINE LOEND**

Rahvusvahelise klassifikatsiooni klass ja alaklass(id)	Registreerimis-taotluse number	Registreeringu number
--	--------------------------------	-----------------------

02-02	D200700082	01355	14-03	D200700052	01341
02-02	D200700083	01356	14-03	D200700053	01342
03-01	D200700084	01357	14-03	D200700057	01344
05-06	D200700016	01331	14-03	D200700058	01345
09-01	D200700068	01350	14-03	D200700059	01346
09-03	D200700074	01351	14-03	D200700060	01347
09-03	D200700075	01352	14-03	D200700061	01348
09-03	D200700076	01353	17-03	D200700041	01336
09-03	D200700077	01354	19-06	D200700084	01357
09-05	D200700016	01331	20-03	D200700033	01333
12-08	D200700040	01335	20-03	D200700033A	01334
14-02	D200700058	01345	23-03	D200700031	01332
14-03	D200700045	01337	25-01	D200700001	01330
14-03	D200700047	01338	25-01	D200700055	01343
14-03	D200700050	01339	25-02	D200700055	01343
14-03	D200700051	01340	25-03	D200700067	01349

REGISTREERITUD TÖÖSTUSDISAINILAHENDUSTE REGISTREERIMISTAOTLUSTE NUMBRILINE LOEND

Registreerimis-taotluse number	Registreeringu number	Rahvusvahelise klassifikatsiooni klass(id) ja alaklass(id)
--------------------------------	-----------------------	--

D200700001	01330	25-01	D200700057	01344	14-03
D200700016	01331	05-06	D200700058	01345	14-02
D200700016	01331	09-05	D200700058	01345	14-03
D200700031	01332	23-03	D200700059	01346	14-03
D200700033	01333	20-03	D200700060	01347	14-03
D200700033A	01334	20-03	D200700061	01348	14-03
D200700040	01335	12-08	D200700067	01349	25-03
D200700041	01336	17-03	D200700068	01350	09-01
D200700045	01337	14-03	D200700074	01351	09-03
D200700047	01338	14-03	D200700075	01352	09-03
D200700050	01339	14-03	D200700076	01353	09-03
D200700051	01340	14-03	D200700077	01354	09-03
D200700052	01341	14-03	D200700082	01355	02-02
D200700053	01342	14-03	D200700083	01356	02-02
D200700055	01343	25-01	D200700084	01357	03-01
D200700055	01343	25-02	D200700084	01357	19-06

AVALDATUD RAHVUSVAHELISE REGISTREERINGU REGISTREERIMISE OTSUSE TEADETE NUMBRILINE LOEND

DM/068408	DM/068562	DM/068594	DM/068594	DM/068609	DM/068640	DM/068698	DM/068730
DM/068469	DM/068562	DM/068594	DM/068594	DM/068609	DM/068655	DM/068698	DM/068730
DM/068473	DM/068562	DM/068594	DM/068609	DM/068610	DM/068665	DM/068698	
DM/068562	DM/068563	DM/068594	DM/068609	DM/068630	DM/068698	DM/068698	
DM/068562	DM/068575	DM/068594	DM/068609	DM/068630	DM/068698	DM/068698	

XIII. TÖÖSTUSDISAINIALASED ÕIGUSAKTID JA MUU INFO**RIIKLIKUS PATENDIVOLNIKE REGISTRIS REGISTREERITUD PATENDIVOLNIKE NIMEKIRI**
(seisuga 18. oktoober 2007)

Register on asutatud 1. septembril 2001. a Vabariigi Valitsuse 7. augusti 2001. a määrusega nr 271 "Riikliku patendivolinike registri asutamine ja registri pidamise põhimäärus" (RT I 2001, 70, 426) patendivoliniku seaduse § 21 alusel (RT I 2001, 27, 151).

TEGEVUSVALDKOND: KAUBAMÄRK, TÖÖSTUSDISAINILAHENDUS JA GEOGRAAFILINE TÄHIS

Arno ANIJALG	OÜ USTERVALL Kivi 21-6 51009 Tartu pk 21, 50002 Tartu telefon: 744 1980 telefaks: 744 1785 e-post: anijalg@ustervall.ee http://www.ustervall.ee võõrkeeled: saksa, vene	Juhan HÄMMALOV	OÜ Intels Riia 11-3 51010 Tartu telefon: 742 0401 telefaks: 742 0326 e-post: intelses@estpak.ee võõrkeeled: inglise, saksa, vene
Aivo ARULA	Patendibüroo Käosaar & Co OÜ Tähe 94 50107 Tartu telefon: 738 3051 telefaks: 738 3055 e-post: info@kaosaar.ee http://www.kaosaar.ee võõrkeeled: inglise, vene	Uno JÄÄGER	Inseneribüroo Uneko OÜ Rüütli 51a, 80010 Pärnu telefon: 447 1021 telefaks: 447 1001 GSM: 515 1844 e-post: uno@estpak.ee võõrkeeled: inglise, soome, vene
Martina BÖCKLER-LORVI	OÜ LASVET Suurtüki 4a, 10133 Tallinn pk 3136, 10505 Tallinn telefon: 640 6600 telefaks: 640 6604 e-post: lasvet@lasvet.ee http://www.lasvet.ee võõrkeeled: inglise, soome	Sirje KAHU	OÜ USTERVALL Kivi 21-6 51009 Tartu pk 21, 50002 Tartu telefon: 744 1980 telefaks: 744 1785 e-post: skahu@ustervall.ee http://www.ustervall.ee võõrkeeled: inglise, vene
Indrek EELMETS	Advokaadibüroo Sorainen OÜ Pärnu mnt 15 10141 Tallinn telefon: 640 0900 telefaks: 640 0901 e-post: sorainen@sorainen.ee http://www.sorainen.com võõrkeeled: inglise, vene, soome	Lembit KALEV	Patendibüroo ROOSILLA OÜ Järveotsa tee 39-61 13520 Tallinn telefon: 657 1722, 657 5381 telefaks: 657 5381 GSM: 511 9951 e-post: roosilla@roosilla.ee http://www.roosilla.ee võõrkeeled: inglise, vene
Alla HÄMMALOV	OÜ Intels Riia 11-3 51010 Tartu telefon: 742 0401 telefaks: 742 0326 e-post: intelses@estpak.ee võõrkeeled: inglise, poola, vene	Anneli KANG	OÜ Synest pk 977, 13402 Tallinn telefon: 660 9786 telefaks: 660 9787 e-post: anneli@synest.ee võõrkeeled: inglise, saksa, vene, prantsuse, soome, rootsi

- Urmast KAULER** **Patendibüroo TURVAJA OÜ**
Liivalaia 22
10118 Tallinn
telefon: 640 3109
telefaks: 640 3105
e-post: kauler@turvaja.ee
http://www.turvaja.ee
võõrkeeled: inglise, vene, soome
- Urmast KERNU** **AAA Patendibüroo OÜ**
Tartu mnt 16
10117 Tallinn
pk 3926, 10509 Tallinn
telefon: 660 5910, 660 5911
telefaks: 660 5912
e-post: aaa@aaa.ee
http://www.aaa.ee
võõrkeeled: inglise, saksa, soome, vene
- Ljubov KESSELMAN** **OÜ Kesna**
Tedre 77-52
10616 Tallinn
telefon: 660 8068
telefaks: 660 8069
e-post: kesna@kesna.ee
http://www.kesna.ee
võõrkeeled: inglise, vene
- Marina KESSELMAN** **OÜ Kesna**
Tedre 77-52
10616 Tallinn
telefon: 660 8068
telefaks: 660 8069
e-post: kesna@kesna.ee
http://www.kesna.ee
võõrkeeled: inglise, saksa, vene
- Heinu KOITEL** **Patendi- & Kaubamärgibüroo Koitel OÜ**
Tartu mnt 65
10115 Tallinn
pk 1759, 10902 Tallinn
telefon: 603 3260
telefaks: 603 3261
e-post: koitel@koitel.ee
http://www.koitel.ee
võõrkeeled: inglise, soome, vene
- Raivo KOITEL** **Patendi- & Kaubamärgibüroo Koitel OÜ**
Tartu mnt 65
10115 Tallinn
pk 1759, 10902 Tallinn
telefon: 603 3260
telefaks: 603 3261
e-post: koitel@koitel.ee
http://www.koitel.ee
võõrkeeled: inglise, soome, vene
- Mart Enn KOPPEL** **Patendibüroo Koppel OÜ**
Kajaka 4-10
11317 Tallinn
telefon: 677 4136
telefaks: 677 4138
e-post: info@koppelpb.com
http://www.koppelpb.com
võõrkeeled: inglise, vene, soome
- Heinrich KRUPP** **Patendibüroo TURVAJA OÜ**
Liivalaia 22
10118 Tallinn
telefon: 640 3109
telefaks: 640 3105
e-post: turvaja@turvaja.ee
http://www.turvaja.ee
võõrkeeled: saksa, vene
- Jüri KÄOSAAR** **Patendibüroo Käosaar & Co OÜ**
Tähe 94
50107 Tartu
telefon: 738 3051
telefaks: 738 3055
e-post: info@kaosaar.ee
http://www.kaosaar.ee
võõrkeeled: inglise, vene
- Kalev KÄOSAAR** **Patendibüroo Käosaar & Co OÜ**
Peterburi tee 46
11415 Tallinn
telefon: 637 9484
telefaks: 637 9485
e-post: kalev.kaosaar@kaosaar.ee
http://www.kaosaar.ee
võõrkeeled: inglise, vene
- Reet MAASIKAMÄE** **OÜ Kaitsepurus**
Mulla 4-3
10611 Tallinn
telefon: 673 9097, 633 2798
telefaks: 677 4844
e-post: purus@online.ee
purus@hot.ee
http://www.hot.ee/purus/
võõrkeeled: inglise, vene
- Raivo MATSOO** **RM Hirvela Patendibüroo OÜ**
Saku 15, 11314 Tallinn
telefon: 614 0816
telefaks: 614 0818
e-post: hirvela@hirvela.ee
võõrkeeled: inglise, vene

Elle MELLIK	AAA Patendibüroo OÜ Tartu mnt 16 10117 Tallinn pk 3926, 10509 Tallinn telefon: 660 5910, 660 5911 telefaks: 660 5912 e-post: aaa@aaa.ee http://www.aaa.ee võõrkeeled: inglise, vene	Jaak OSTRAT	OÜ LASVET Suurtüki 4a, 10133 Tallinn pk 3136, 10505 Tallinn telefon: 640 6600 telefaks: 640 6604 e-post: lasvet@lasvet.ee http://www.lasvet.ee võõrkeeled: inglise, saksa, soome, vene
Lembit MITT	AAA Patendibüroo OÜ Tartu mnt 16 10117 Tallinn pk 3926, 10509 Tallinn telefon: 660 5910, 660 5911 telefaks: 660 5912 e-post: aaa@aaa.ee http://www.aaa.ee võõrkeeled: inglise, vene	Villu PAVELTS	OÜ LASVET Suurtüki 4a, 10133 Tallinn pk 3136, 10505 Tallinn telefon: 640 6600 telefaks: 640 6604 e-post: lasvet@lasvet.ee http://www.lasvet.ee võõrkeeled: inglise, soome, vene
Ott MOORLAT	OÜ Moorlat & Ko Patendibüroo pk 723, 12902 Tallinn telefon: 655 0450, 654 2844 telefaks: 654 2844 e-post: ott.moorlat@moorlat.ee http://www.moorlat.ee võõrkeeled: inglise, vene	Toom PUNGAS	OÜ Synest pk 977, 13402 Tallinn telefon: 660 9786 telefaks: 660 9787 e-post: toom@synest.ee võõrkeeled: inglise, saksa, soome, vene
Anfia MORNA	Patendibüroo TURVAJA OÜ Liivalaia 22, 10118 Tallinn telefon: 640 3109 telefaks: 640 3105 e-post: morna@turvaja.ee http://www.turvaja.ee võõrkeeled: inglise, vene	Kaie PUUR	Patendibüroo Käosaar & Co OÜ Tähe 94 50107 Tartu telefon: 738 3051 telefaks: 738 3055 e-post: info@kaosaar.ee http://www.kaosaar.ee võõrkeeled: inglise, vene
Tõnu NELSAS	AAA Patendibüroo OÜ Tartu mnt 16 10117 Tallinn pk 3926, 10509 Tallinn telefon: 660 5910, 660 5911 telefaks: 660 5912 e-post: aaa@aaa.ee http://www.aaa.ee võõrkeeled: inglise, vene, soome	Riina PÄRN	OÜ Intels Riia 11-3 51010 Tartu telefon: 742 0401 telefaks: 742 0326 e-post: intelses@estpak.ee võõrkeeled: inglise, vene
Jüri OLT	Patendibüroo Käosaar & Co OÜ Tähe 94, 50107 Tartu telefon: 738 3051 telefaks: 738 3055 e-post: info@kaosaar.ee http://www.kaosaar.ee võõrkeeled: inglise, saksa, soome, vene	Tarmo ROSMAN	Rosman ja Partnerid OÜ pk 652, 12602 Tallinn telefon: 656 1450 telefaks: 656 1450 e-post: tarman@cc.ttu.ee võõrkeeled: saksa, inglise, ungari, vene
		Arvo SALUMÄE	OÜ Amende Patendibüroo Raua 65 10152 Tallinn telefon: 648 6125 telefaks: 641 0174 e-post: amende@hot.ee võõrkeeled: inglise, saksa, soome, vene

Almar SEHVER**AAA Patendibüroo OÜ**

Tartu mnt 16
10117 Tallinn
pk 3926, 10509 Tallinn
telefon: 660 5910, 660 5911
telefaks: 660 5912
e-post: aaa@aaa.ee
<http://www.aaa.ee>
võõrkeeled: inglise, vene

Olga TREUFELDT**Patendibüroo TURVAJA OÜ**

Liivalaia 22
10118 Tallinn
telefon: 640 3109
telefaks: 640 3105
e-post: olga@turvaja.ee
<http://www.turvaja.ee>
võõrkeeled: inglise, vene

Harald TEHVER**Patendibüroo TURVAJA OÜ**

Liivalaia 22
10118 Tallinn
telefon: 640 3109
telefaks: 640 3105
e-post: tehver@turvaja.ee
<http://www.turvaja.ee>
võõrkeeled: inglise, saksa, vene

Enn URGAS**Patendibüroo TURVAJA OÜ**

Liivalaia 22
10118 Tallinn
telefon: 640 3109
telefaks: 640 3105
e-post: urgas@turvaja.ee
<http://www.turvaja.ee>
võõrkeeled: inglise, vene

Mari TOOMSOO**OÜ Advokaadibüroo Raidla & Partnerid**

Roosikrantsi 2, 10119 Tallinn
telefon: 640 7170
telefaks: 640 7171
e-post: email@raidla.ee
<http://www.raidla.ee>
võõrkeeled: inglise, soome

Juta-Maris UUSTALU**OÜ Amende Patendibüroo**

Raua 65
10152 Tallinn
telefon: 648 6125
telefaks: 641 0174
e-post: amende@hot.ee
võõrkeeled: inglise, vene

**LIST OF PATENT ATTORNEYS, REGISTERED IN
THE ESTONIAN STATE REGISTER OF PATENT ATTORNEYS
(by 18 October 2007)**

Register is established on September 1st 2001

FIELD OF ACTIVITY: TRADEMARKS, INDUSTRIAL DESIGNS AND GEOGRAPHICAL INDICATIONS

Arno ANIJALG	USTERVALL Ltd. Kivi 21-6 51009 Tartu, Estonia P.O. Box 21 50002 Tartu, Estonia Phone: +372 744 1980 Fax: +372 744 1785 E-mail: anijalg@ustervall.ee Http://www.ustervall.ee German, Russian, Estonian	Juhan HÄMMALOV	Intels Ltd. Riia Str. 11-3 51010 Tartu, Estonia Phone: +372 742 0401 Fax: +372 742 0326 E-mail: intelses@estpak.ee English, German, Russian, Estonian
Aivo ARULA	Patent Agency Käosaar & Co Tähe Str. 94 50107 Tartu, Estonia Phone: +372 738 3051 Fax: +372 738 3055 E-mail: info@kaosaar.ee Http://www.kaosaar.ee English, Russian, Estonian	Uno JÄÄGER	Inseneribüroo Uneko Ltd. Rüütli 51a 80010 Pärnu, Estonia Phone: +372 447 1021 Fax: +372 447 1001 GSM: +372 515 1844 E-mail: uno@estpak.ee English, Finnish, Russian, Estonian
Martina BÖCKLER-LORVI	Lasvet Ltd. P.O. Box 3136 10505 Tallinn, Estonia Phone: +372 640 6600 Fax: +372 640 6604 E-mail: lasvet@lasvet.ee Http://www.lasvet.ee English, Finnish, Estonian	Sirje KAHU	USTERVALL Ltd. Kivi 21-6 51009 Tartu, Estonia P.O. Box 21 50002 Tartu, Estonia Phone: +372 744 1980 Fax: +372 744 1785 E-mail: skahu@ustervall.ee Http://www.ustervall.ee English, Russian, Estonian
Indrek EELMETS	Sorainen Law Office Pärnu Road 15 10141 Tallinn, Estonia Phone: +372 640 0900 Fax: +372 640 0901 E-mail: sorainen@sorainen.ee Http://www.sorainen.com English, Russian, Finnish, Estonian	Lembit KALEV	Patent Bureau ROOSILLA Ltd. Järveotsa Road 39-61 13520 Tallinn, Estonia Phone: +372 657 1722 +372 657 5381 Fax: +372 657 5381 GSM: +372 511 9951 E-mail: roosilla@roosilla.ee Http://www.roosilla.ee English, Russian, Estonian
Alla HÄMMALOV	Intels Ltd. Riia Str. 11-3 51010 Tartu, Estonia Phone: +372 742 0401 Fax: +372 742 0326 E-mail: intelses@estpak.ee English, Polish, Russian, Estonian	Anneli KANG	Synest Ltd. P.O. Box 977 13402 Tallinn, Estonia Phone: +372 660 9786 Fax: +372 660 9787 E-mail: anneli@synest.ee English, German, Russian, French, Finnish, Swedish, Estonian

Urmas KAULER	Patendibüroo TURVAJA OÜ Liivalaia 22 10118 Tallinn, Estonia Phone: +372 640 3109 Fax: +372 640 3105 E-mail: kauler@turvaja.ee Http://www.turvaja.ee English, Russian, Finnish, Estonian	Raivo KOITEL	Patent & Trademark Agency Koitel Tartu Road 65 10115 Tallinn, Estonia P.O. Box 1759 10902 Tallinn, Estonia Phone: +372 603 3260 Fax: +372 603 3261 E-mail: koitel@koitel.ee Http://www.koitel.ee English, Finnish, Russian, Estonian
Urmas KERNU	AAA Legal Services Tartu Road 16 10117 Tallinn, Estonia P.O. Box 3926 10509 Tallinn, Estonia Phone: +372 660 5910 +372 660 5911 Fax: +372 660 5912 E-mail: aaa@aaa.ee Http://www.aaa.ee English, German, Finnish, Russian, Estonian	Mart Enn KOPPEL	Patent Bureau Koppel Kajaka 4-10 11317 Tallinn, Estonia Phone: +372 677 4136 Fax: +372 677 4138 E-mail: info@koppelpb.com Http://www.koppelpb.com English, Russian, Finnish, Estonian
Marina KESSELMAN	Kesna Ltd. Tedre Str. 77-52 10616 Tallinn, Estonia Phone: +372 660 8068 Fax: +372 660 8069 E-mail: kesna@kesna.ee Http://www.kesna.ee English, German, Russian, Estonian	Heinrich KRUPP	Patendibüroo TURVAJA OÜ Liivalaia 22 10118 Tallinn, Estonia Phone: +372 640 3109 Fax: +372 640 3105 E-mail: turvaja@turvaja.ee Http://www.turvaja.ee German, Russian, Estonian
Ljubov KESSELMAN	Kesna Ltd. Tedre Str. 77-52 10616 Tallinn, Estonia Phone: +372 660 8068 Fax: +372 660 8069 E-mail: kesna@kesna.ee Http://www.kesna.ee English, Russian, Estonian	Jüri KÄOSAAR	Patent Agency Käosaar & Co Tähe Str. 94 50107 Tartu, Estonia Phone: +372 738 3051 Fax: +372 738 3055 E-mail: info@kaosaar.ee Http://www.kaosaar.ee English, Russian, Estonian
Heinu KOITEL	Patent & Trademark Agency Koitel Tartu Road 65 10115 Tallinn, Estonia P.O. Box 1759 10902 Tallinn, Estonia Phone: +372 603 3260 Fax: +372 603 3261 E-mail: koitel@koitel.ee Http://www.koitel.ee English, Finnish, Russian, Estonian	Kalev KÄOSAAR	Patent Agency Käosaar & Co Peterburi Road 46 11415 Tallinn, Estonia Phone: +372 637 9484 Fax: +372 637 9485 E-mail: kalev.kaosaar@kaosaar.ee Http://www.kaosaar.ee English, Russian, Estonian

- Reet MAASIKAMÄE Patent Bureau Kaitsepurus Ltd.**
Mulla Str. 4-3
10611 Tallinn, Estonia
Phone: +372 673 9097
+372 633 2798
Fax: +372 677 4844
E-mail: purus@online.ee
purus@hot.ee
Http://www.hot.ee/purus/
English, Russian, Estonian
- Raivo MATSOO RM Hirvela Patent Bureau Ltd**
Saku 15, 11314 Tallinn, Estonia
Phone: +372 614 0816
Fax: +372 614 0818
E-mail: hirvela@hirvela.ee
English, Russian, Estonian
- Elle MELLIK AAA Legal Services**
Tartu Road 16
10117 Tallinn, Estonia
P.O. Box 3926
10509 Tallinn, Estonia
Phone: +372 660 5910
+372 660 5911
Fax: +372 660 5912
E-mail: aaa@aaa.ee
Http://www.aaa.ee
English, Russian, Estonian
- Lembit MITT AAA Legal Services**
Tartu Road 16
10117 Tallinn, Estonia
P.O. Box 3926
10509 Tallinn, Estonia
Phone: +372 660 5910
+372 660 5911
Fax: +372 660 5912
E-mail: aaa@aaa.ee
Http://www.aaa.ee
English, Russian, Estonian
- Ott MOORLAT Moorlat & Co Ltd. Patent Bureau**
P.O. Box 723
12902 Tallinn, Estonia
Phone: +372 655 0450
+372 654 2844
Fax: +372 654 2844
E-mail: ott.moorlat@moorlat.ee
Http://www.moorlat.ee
English, Russian, Estonian
- Anfia MORNA**
- Tõnu NELSAS**
- Jüri OLT**
- Jaak OSTRAT**
- Villu PAVELTS**
- Toom PUNGAS**
- Patendibüroo TURVAJA OÜ**
Liivalaia 22
10118 Tallinn, Estonia
Phone: +372 640 3109
Fax: +372 640 3105
E-mail: morna@turvaja.ee
Http://www.turvaja.ee
English, Russian, Estonian
- AAA Legal Services**
Tartu Road 16
10117 Tallinn, Estonia
P.O. Box 3926
10509 Tallinn, Estonia
Phone: +372 660 5910
+372 660 5911
Fax: +372 660 5912
E-mail: aaa@aaa.ee
Http://www.aaa.ee
English, Russian, Finnish, Estonian
- Patent Agency Käosaar & Co**
Tähe Str. 94
50107 Tartu, Estonia
Phone: +372 738 3051
Fax: +372 738 3055
E-mail: info@kaosaar.ee
Http://www.kaosaar.ee
English, German, Finnish, Russian, Estonian
- Lasvet Ltd.**
P.O. Box 3136
10505 Tallinn, Estonia
Phone: +372 640 6600
Fax: +372 640 6604
E-mail: lasvet@lasvet.ee
Http://www.lasvet.ee
English, German, Finnish, Russian, Estonian
- Lasvet Ltd.**
P.O. Box 3136
10505 Tallinn, Estonia
Phone: +372 640 6600
Fax: +372 640 6604
E-mail: lasvet@lasvet.ee
Http://www.lasvet.ee
English, Finnish, Russian, Estonian
- Synest Ltd.**
P.O. Box 977
13402 Tallinn, Estonia
Phone: +372 660 9786
Fax: +372 660 9787
E-mail: toom@synest.ee
English, German, Finnish, Russian, Estonian

- Kaie PUUR** **Patent Agency Käosaar & Co**
Tähe Str. 94
50107 Tartu, Estonia
Phone: +372 738 3051
Fax: +372 738 3055
E-mail: info@kaosaar.ee
Http://www.kaosaar.ee
English, Russian, Estonian
- Riina PÄRN** **Intels Ltd.**
Riia Str. 11-3
51010 Tartu, Estonia
Phone: +372 742 0401
Fax: +372 742 0326
E-mail: intelses@estpak.ee
English, Russian,
Estonian
- Tarmo ROSMAN** **Rosman and Partners Ltd.**
P.O. Box 652
12602 Tallinn, Estonia
Phone: +372 656 1450
Fax: +372 656 1450
E-mail: tarman@cc.ttu.ee
German, English, Hungarian,
Russian, Estonian
- Arvo SALUMÄE** **AMENDE Patent Agency Ltd.**
Raua 65, 10152 Tallinn, Estonia
Phone: +372 648 6125
Fax: +372 641 0174
E-mail: amende@hot.ee
English, German, Finnish,
Russian, Estonian
- Almar SEHVER** **AAA Legal Services**
Tartu Road 16
10117 Tallinn, Estonia
P.O. Box 3926
10509 Tallinn, Estonia
Phone: +372 660 5910
+372 660 5911
Fax: +372 660 5912
E-mail: aaa@aaa.ee
Http://www.aaa.ee
English, Russian, Estonian
- Harald TEHVER** **Patendibüroo TURVAJA OÜ**
Liivalaia 22
10118 Tallinn, Estonia
Phone: +372 640 3109
Fax: +372 640 3105
E-mail: tehver@turvaja.ee
Http://www.turvaja.ee
English, German, Russian,
Estonian
- Mari TOOMSOO** **RAIDLA & PARTNERS**
Roosikrantsi 2
10119 Tallinn, Estonia
Phone: +372 640 7170
Fax: +372 640 7171
E-mail: email@raidla.ee
Http://www.raidla.ee
English, Finnish, Estonian
- Olga TREUFELDT** **Patendibüroo TURVAJA OÜ**
Liivalaia 22
10118 Tallinn, Estonia
Phone: +372 640 3109
Fax: +372 640 3105
E-mail: olga@turvaja.ee
Http://www.turvaja.ee
English, Russian, Estonian
- Enn URGAS** **Patendibüroo TURVAJA OÜ**
Liivalaia 22
10118 Tallinn, Estonia
Phone: +372 640 3109
Fax: +372 640 3105
E-mail: urgas@turvaja.ee
Http://www.turvaja.ee
English, Russian, Estonian
- Juta-Maris UUSTALU** **AMENDE Patent Agency Ltd.**
Raua 65, 10152 Tallinn, Estonia
Phone: +372 648 6125
Fax: +372 641 0174
E-mail: amende@hot.ee
English, Russian, Estonian