



ISSN 1406-376X

EESTI VABARIIK

T **EESTI**
TÖÖSTUSDISAINI-
LAHENDUSE LEHT



PATENDIAMETI AMETLIK VÄLJAANNE

2
2008
TALLINN



ISSN 1406-376X

EESTI VABARIIK

T

EESTI

TÖÖSTUSDISAINI-

LAHENDUSE LEHT

**PATENDIAMETI
AMETLIK VÄLJAANNE**

XI aastakäik

**Käesolevas numbris
esitatud andmed
loetakse avaldatuks
15. mail 2008. a.**

2
2008
MAI
TALLINN

Eesti Tööstusdisainilahenduse Lehte antakse välja tööstusdisaini kaitse seaduse (jõustunud 11.01.1998) alusel.
The Estonian Industrial Design Gazette is the official publication of the Estonian Patent Office.
Published under Industrial Design Protection Law of the Republic of Estonia (coming into force 11 January 1998).
Date of publication of the data presented in this issue - 15 May 2008.

Patendiameti
infoosakond
Toompuiestee 7
15041 Tallinn
Tel 627 7907
Faks 627 7943
E-post Info@epa.ee

The Information Department
of the Estonian Patent Office
Toompuiestee 7
15041 Tallinn, ESTONIA
Phone +372 627 7907
Fax +372 627 7943
E-mail Info@epa.ee

Levitaja

Eesti Patendiraamatukogu
Olevimägi 8/10
10123 Tallinn
Tel 641 1248
Faks 641 1018
E-post patent@patentlib.ee

Distributor

Estonian Patent Library
Olevimägi 8/10
10123 Tallinn, ESTONIA
Phone +372 641 1248
Fax +372 641 1018
E-mail patent@patentlib.ee

SISUKORD

Andmete identifitseerimise rahvusvahelised numberkoodid (INID-koodid)	4
Riikide, teiste ühenduste ja valitsustevaheliste organisatsioonide koodid	5
I. REGISTREERITUD TÖÖSTUSDISAINILAHENDUSED	6
II. RAHVUSVAHELISELT REGISTREERITUD TÖÖSTUSDISAINILAHENDUSED	47
III. MUUD REGISTRIKANDED	97
Registreeringu kehtivuse pikendamine	97
Tööstusdisainilahenduse üleminek	97
Registreeringu jagamine	-
Registreeringu andmete muudatused	97
Registreeringu andmete parandused	99
Tööstusdisainilahenduse litsentsimine	-
Tööstusdisainilahenduse pantimine	-
Tööstusdisainilahenduse tunnistuse duplikaadi väljaandmine	-
Registreeringu kustutamine	99
IV. LOENDID	100
Registreeritud tööstusdisainilahenduste registreerimise taotluste numbriline loend	100
Rahvusvaheliselt registreeritud tööstusdisainilahenduste numbriline loend	100
V. TÖÖSTUSDISAINIALASED ÕIGUSAKTID JA MUU INFO	101
Riiklikus patendivolinike registris registreeritud patendivolinike nimekiri	101

CONTENTS

Internationally Agreed Numbers for the Identification of Data (INID Codes)	4
List of Codes of States, Other Entities and Intergovernmental Organizations	5
I. REGISTERED INDUSTRIAL DESIGNS	6
II. INTERNATIONALLY REGISTERED INDUSTRIAL DESIGNS	47
III. OTHER ENTRIES IN THE REGISTER	97
Extension of the Registration	97
Transfer of Industrial Design	97
Division of the Registration.	-
Amendments to Registration Data	97
Corrections to Registration Data	99
Licensing of Industrial Design	-
Pledging of Industrial Design	-
Issue of a Copy of the Industrial Design Certificate	-
Deletion of the Registration	99
IV. LISTS	100
Numerical List of Registration Applications of Registered Industrial Designs	100
Numerical List of Internationally Registered Industrial Designs	100
V. LEGAL ACTS AND INFORMATION CONCERNING INDUSTRIAL DESIGNS	101
List of Patent Attorneys, Registered in the Estonian State Register of Patent Attorneys	105

**ANDMETE IDENTIFITSEERIMISE
RAHVUSVAHELISED NUMBERKOODID
(INID-KOODID)
WIPO Standard ST. 80**

**INTERNATIONALLY AGREED NUMBERS FOR
THE IDENTIFICATION OF DATA
(INID CODES)
WIPO Standard ST. 80**

(11) Registreeringu number	(11) Number of the Registration
(15) Registreerimise kuupäev	(15) Date of the Registration
(18) Registreeringu kehtivuse lõppemise kuupäev	(18) Expected expiration date of the registration
(21) Registreerimistaotluse number	(21) Application Number
(22) Registreerimistaotluse esitamise kuupäev	(22) Application Filing Date
(24) Registreeringu kehtivuse alguse kuupäev	(24) Date from which the Industrial Design right has effected
(28) Variantide arv	(28) Number of Industrial Designs included in the application
(30) Prioriteet	(30) Priority
(51) Rahvusvahelise klassifikatsiooni klassi ja alaklassi number	(51) International Classification for Industrial Designs (class and subclass of the Locarno Classification)
(54) Tööstusdisainilahenduse nimetus	(54) Title of the Industrial Design
(55) Tööstusdisainilahenduse reproduktsioon	(55) Reproduction of the Industrial Design
(72) Tööstusdisainilahenduse autor(id)	(72) Author(s) of Industrial Design
(73) Tööstusdisainilahenduse omanik(ud)	(73) Proprietor(s) of Industrial Design
(74) Patendivolinik või ühine esindaja	(74) Patent Attorney or Common Representative

**RIIKIDE, TEISTE ÜHENDUSTE JA VALITSUSTEVAAHELISTE
ORGANISATSIOONIDE KOODID**

AD	Andorra	DZ	Alžeeria	JM	Jamaica	PW	Belau
AE	Araabia	EA	Euraasia	JO	Jordaania	PY	Paraguay
	Ühendemiraadid		Patendiorganisat-	JP	Jaapan	QA	Katar
AF	Afganistan		sioon (EAPO)	KE	Kenya	RO	Rumeenia
AG	Antigua ja Barbuda	EC	Ecuador	KG	Kõrgõzstan	RS	Serbia
AI	Anguilla	EE	Eesti	KH	Kambodža	RU	Venemaa
AL	Albaania	EG	Egiptus	KI	Kiribati	RW	Rwanda
AM	Armeenia	EH	Lääne-Sahara	KM	Komoorid	SA	Saudi Araabia
AN	Hollandi Antillid	EM	Siseturu	KN	Saint Kitts ja Nevis	SB	Saalomoni Saared
AO	Angola		Ühtlustamise	KP	Põhja-Korea	SC	Seišellid
AP	Aafrika Regionaalne		Amet (kaubamärgid	KR	Lõuna-Korea	SD	Sudaan
	Tööstusomandi Orga-		ja tööstusdisaini-	KW	Kuveit	SE	Rootsi
	nisatsioon (ARIPO)		lahendused) (OHIM)	KY	Kaimanisaared	SG	Singapur
AR	Argentina	EP	Euroopa	KZ	Kasahstan	SH	Saint Helena
AS	Ameerika Samoa		Patendiamet (EPO)	LA	Laos	SI	Sloveenia
AT	Austria	ER	Eritrea	LB	Liibanon	SK	Slovakkia
AU	Austraalia	ES	Hispaania	LC	Saint Lucia	SL	Sierra Leone
AW	Aruba	ET	Etiopia	LI	Liechtenstein	SM	San Marino
AZ	Aserbaidžaan	FI	Soome	LK	Sri Lanka	SN	Senegal
BA	Bosnia ja	FJ	Fidži	LR	Libeeria	SO	Somaalia
	Hertsegoviina	FK	Falklandi (Malviini)	LS	Lesotho	SR	Suriname
BB	Barbados		saared	LT	Leedu	ST	São Tomé ja Príncipe
BD	Bangladesh	FM	Mikroneesia	LU	Luksemburg	SV	El Salvador
BE	Belgia	FO	Fääri saared	LV	Läti	SY	Süüria
BF	Burkina Faso	FR	Prantsusmaa	LY	Liibüa	SZ	Svaasimaa
BG	Bulgaaria	GA	Gabon	MA	Maroko	TC	Turks ja Caicos
BH	Bahrein	GB	Ühendkuningriik	MC	Monaco	TD	Tšaad
BI	Burundi		(Suurbritannia)	MD	Moldova	TG	Togo
BJ	Benin	GC	Pärsia Lahe	ME	Montenegro	TH	Tai
BM	Bermuda		Koostööõnukogu	MG	Madagaskar	TJ	Tadžikistan
BN	Brunei	GD	Grenada	MH	Marshalli Saared	TM	Türkmenistan
BO	Boliivia	GE	Gruusia	MK	Makedoonia	TN	Tuneesia
BR	Brasiilia	GG	Guernsey	ML	Mali	TO	Tonga
BS	Bahama	GH	Ghana	MM	Myanmar (Birma)	TL	Ida-Timor
BT	Bhutan	GI	Gibraltar	MN	Mongoolia	TR	Türgi
BV	Bouvet' saar	GL	Gröönimaa	MO	Macao	TT	Trinidad ja Tobago
BW	Botswana	GM	Gambia	MP	Põhja-Mariaanid	TV	Tuvalu
BX	Beneluxi	GN	Guinea	MR	Mauritaania	TW	Taiwan (Hiina provints)
	Kaubamärgiamet	GQ	Ekvatoriaal-Guinea	MS	Montserrat	TZ	Tansaania
	(BBM) ja Beneluxi	GR	Kreeka	MT	Malta	UA	Ukraina
	Tööstusdisainilahen-	GS	Lõuna-Georgia ja	MU	Mauritius	UG	Uganda
	duste Amet (BBDM)		Lõuna-Sandwichi	MV	Maldiivid	US	Ameerika
BY	Valgevene		saared	MW	Malawi		Ühendriigid
BZ	Belize	GT	Guatemala	MX	Mehhiko	UY	Uruguay
CA	Kanada	GW	Guinea-Bissau	MY	Malaisia	UZ	Usbekistan
CF	Kesk-Aafrika	GY	Guyana	MZ	Mosambiik	VA	Vatikan (Püha Tool)
	Vabariik	HK	Hongkong	NA	Namiibia	VC	Saint Vincent ja
CG	Kongo	HN	Honduras	NE	Niger		Grenadiinid
CH	Šveits	HR	Horvaatia	NG	Nigeeria	VE	Venezuela
CI	Côte d'Ivoire	HT	Haiti	NI	Nicaragua	VG	Neitsisaared
CK	Cooki saared	HU	Ungari	NL	Holland	VN	Vietnam
CL	Tšiili	IB	Ülemaailmse	NO	Norra	VU	Vanuatu
CM	Kamerun		Intellektuaalomandi	NP	Nepal	WO	Ülemaailmne
CN	Hiina		Organisatsiooni	NR	Nauru		Intellektuaalomandi
CO	Kolumbia		(WIPO) Rahvus-	NZ	Uus-Meremaa		Organisatsioon
CR	Costa Rica		vaheline Büroo	OA	Aafrika Intellektuaal-		(WIPO) (Rahvus-
CU	Kuuba	ID	Indoneesia		omandi Organisat-		vaheline Büroo)
CV	Cabo Verde	IE	Iiri		sioon (OAPI)	WS	Samoa
CY	Küpros	IL	Iisrael	OM	Omaan	YE	Jeemen
CZ	Tšehhi	IM	Man'i saar	PA	Panama	ZA	Lõuna-Aafrika Vabariik
DE	Saksamaa	IN	India	PE	Peruu	ZM	Sambia
DJ	Djibouti	IQ	Iraak	PG	Paapua Uus-Guinea	ZR	Zaire
DK	Taani	IR	Iraan	PH	Filipiinid	ZW	Zimbabwe
DM	Dominica	IS	Island	PK	Pakistan		
DO	Dominikaani	IT	Itaalia	PL	Poola		
	Vabariik	JE	Jersey	PT	Portugal		

I. REGISTREERITUD TÖÖSTUSDISAINILAHENDUSED

Avaldatakse "Tööstusdisaini kaitse seaduse" § 55¹ lõike 7 alusel.

Patendiamet ei ole kontrollinud tööstusdisainilahenduse uudsust ja eristatavust tulenevalt "Tööstusdisaini kaitse seaduse" § 31 lõike 2 punktist 1.

(11) Registreeringu number	01386	(51) Klass: 14-03
(21) Taotluse number	D200700046	
(15) Registreerimise päev	15.05.2008	
(22) Esitamise päev	28.05.2007	
(24) Registreeringu kehtivuse alguse päev	28.05.2007	
(18) Registreeringu kehtivuse lõppemise päev	28.05.2012	
(28) Variantide arv	3	
(30) Prioriteediandmed	29/250,712, 28.11.2006, US	
(72) Autor	Justin Lyles, 12278 Scripps Summit Drive, San Diego, CA 92131, US	
(73) Omanik	Nokia Corporation, Keilalahdentie 4, FIN-02150 Espoo, FI	
(74) Patendivolinik või ühine esindaja	Jüri Käosaar	

(54) Nimetus **Käsitelefon**

(55) Reproduktsoon

01386-1

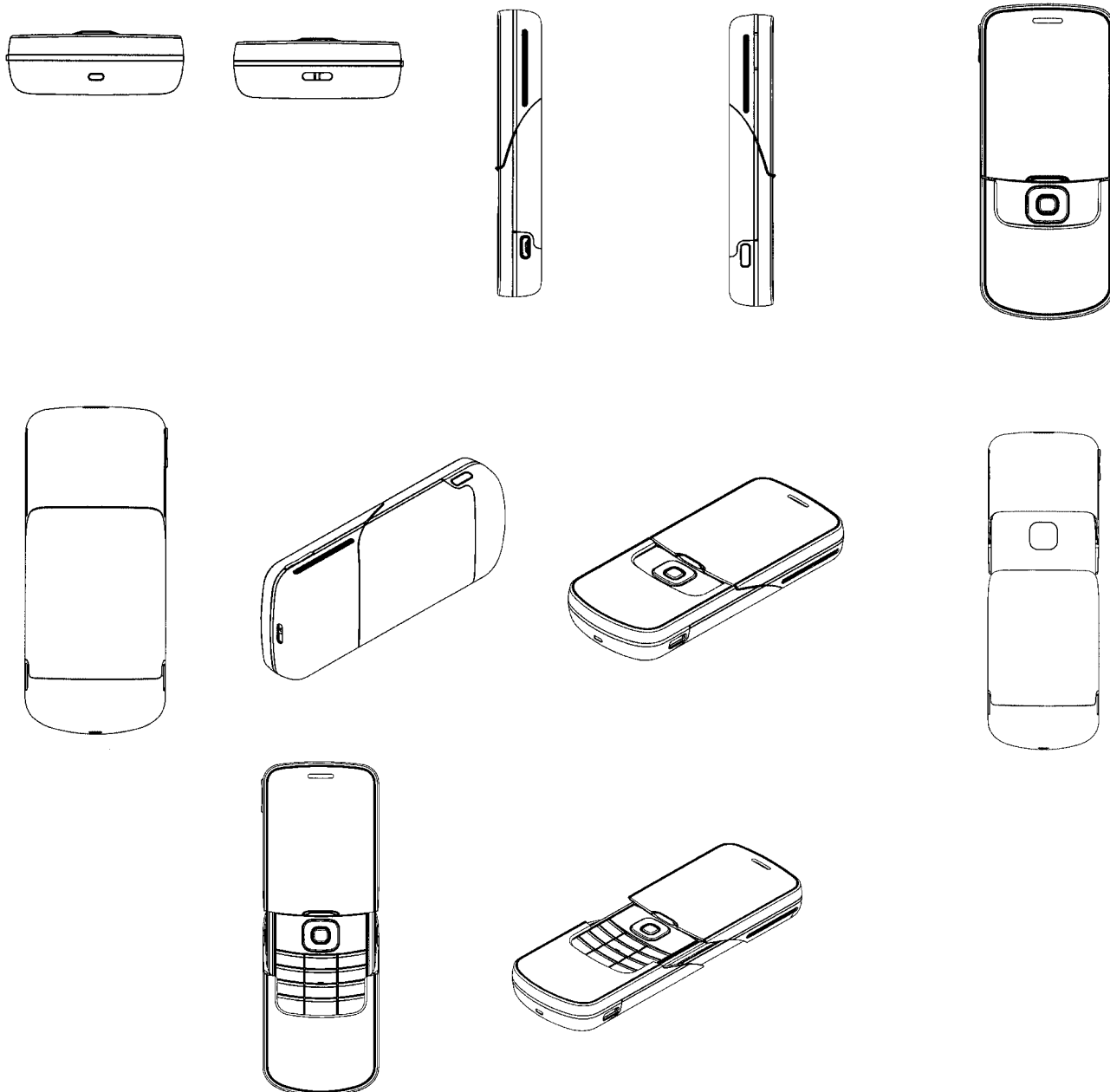

01386-2

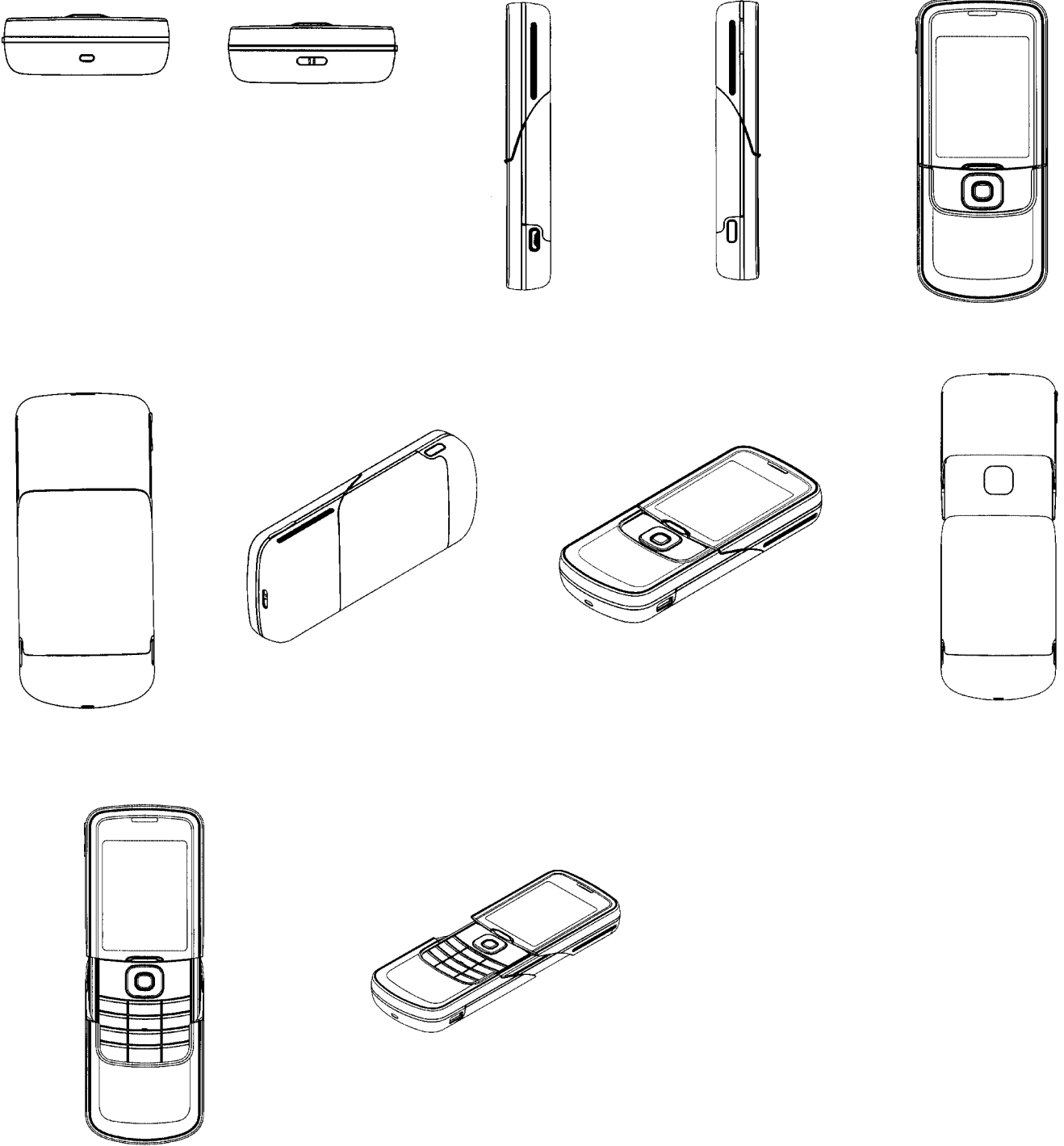

01386-3



- (11) **Registreeringu number** **01387** (51) Klass: **13-03, 07-99**
- (21) **Taotluse number** D200700066
- (15) **Registreerimise päev** 15.05.2008
- (22) **Esitamise päev** 27.07.2007
- (24) **Registreeringu kehtivuse alguse päev** 27.07.2007
- (18) **Registreeringu kehtivuse lõppemise päev** 27.07.2012
- (28) **Variantide arv** 1
- (72) **Autor** Janno Lamus, Rägavere tee 41, Lehtse, 73601 Lääne-Viru maakond, EE
Aare Palmsalu, Pikk 61, Tapa, 45106 Lääne-Viru maakond, EE
- (73) **Omanik** Janno Lamus, Rägavere tee 41, Lehtse, 73601 Lääne-Viru maakond, EE
Aare Palmsalu, Pikk 61, Tapa, 45106 Lääne-Viru maakond, EE
- (74) **Patendivolinik või ühine esindaja** Toom Pungas
- (54) **Nimetus** **Juhtmete hoidel**
- (55) **Reproduktsoon**
- 01387-1

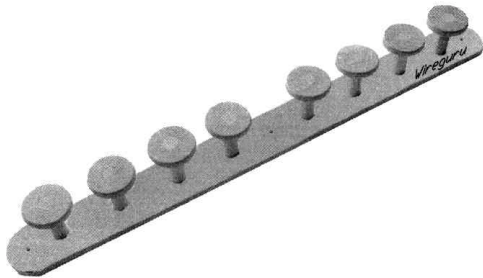

- (11) **Registreeringu number** **01388**
- (21) **Taotluse number** D200700085
- (15) **Registreerimise päev** 15.05.2008
- (22) **Esitamise päev** 21.09.2007
- (24) **Registreeringu kehtivuse alguse päev** 21.09.2007
- (18) **Registreeringu kehtivuse lõppemise päev** 21.09.2012
- (28) **Variantide arv** 1
- (30) **Prioriteediandmed** 29/278,485, 30.03.2007, US
- (72) **Autor** Duncan Burns, #203 18645 Hatteras St., Tarzana, CA 91356, US
- (73) **Omanik** Nokia Corporation, Keilalahdentie 4, FIN-02150 Espoo, FI
- (74) **Patendivolinik või ühine esindaja** Jüri Käosaar

(51) Klass: 14-03

(54) **Nimetus** **Käsitelefon**

(55) **Reproduktsoon**

01388-1

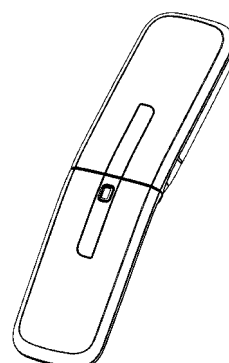
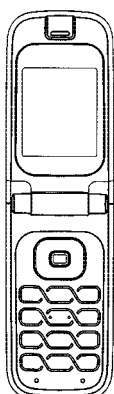
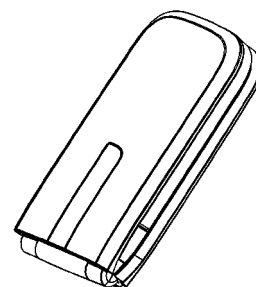
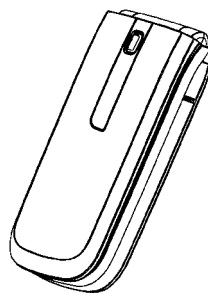
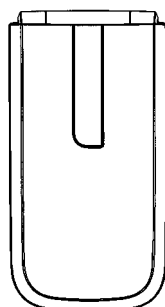
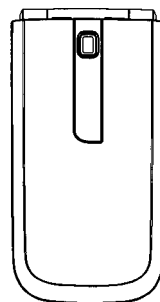

(11) Registreeringu number	01389	(51) Klass: 14-03
(21) Taotluse number	D200700086	
(15) Registreerimise päev	15.05.2008	
(22) Esitamise päev	21.09.2007	
(24) Registreeringu kehtivuse alguse päev	21.09.2007	
(18) Registreeringu kehtivuse lõppemise päev	21.09.2012	
(28) Variantide arv	2	
(30) Prioriteediandmed	29/278,284, 23.03.2007, US	
(72) Autor	Edward Mitchell, 3267 Lanier Place, Thousand Oaks, California 91360, US	
(73) Omanik	Nokia Corporation, Keilalahdentie 4, FIN-02150 Espoo, FI	
(74) Patendivolinik või ühine esindaja	Jüri Käosaar	

(54) **Nimetus** **Käsitelefon**

(55) **Reproduktsoon**

01389-1

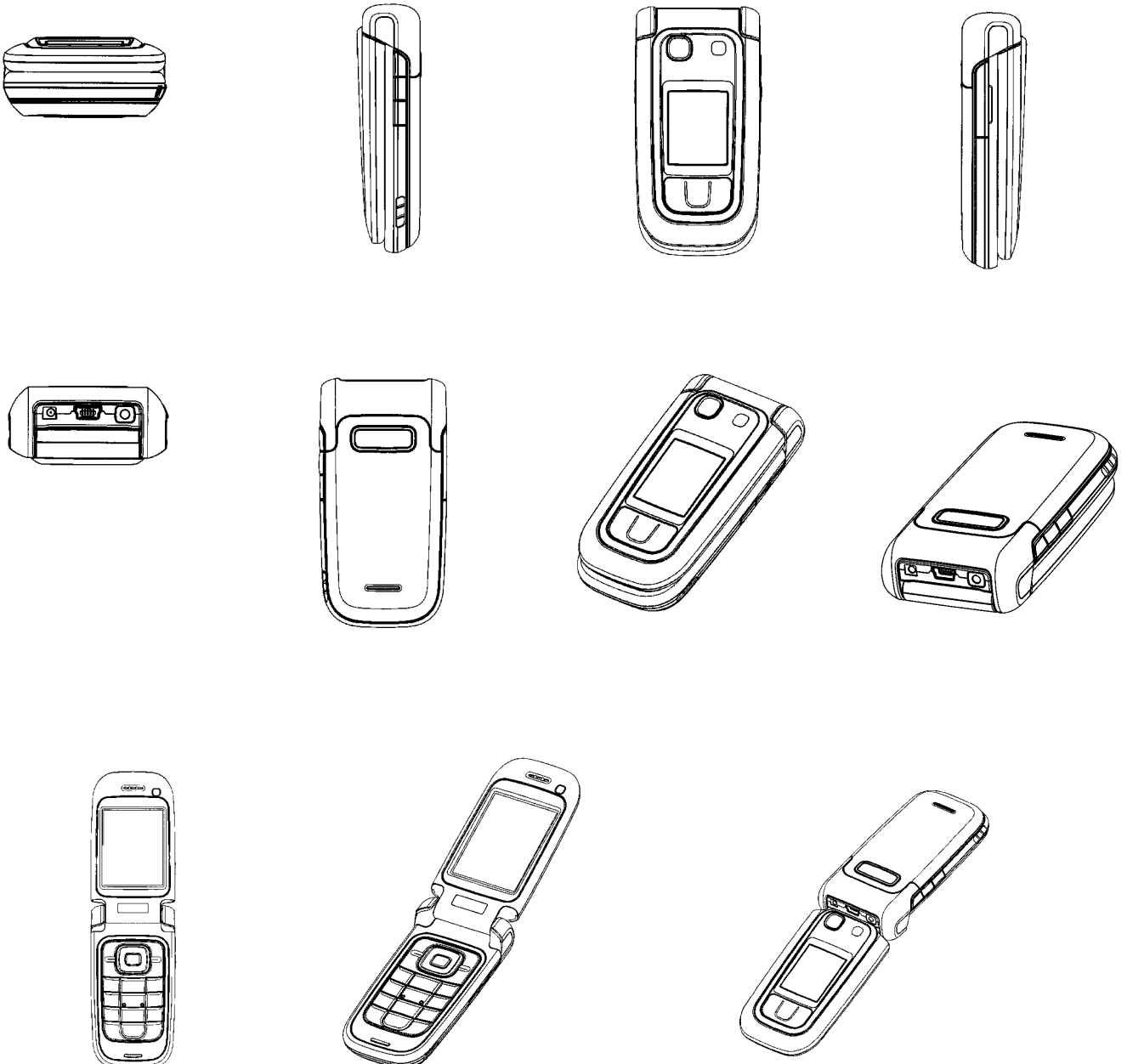

01389-2

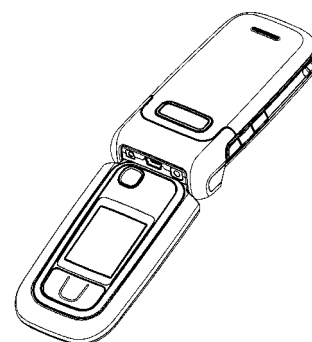
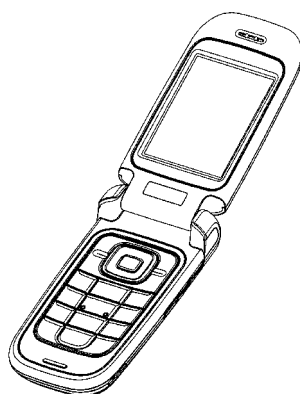
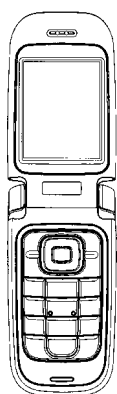
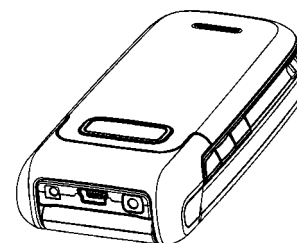
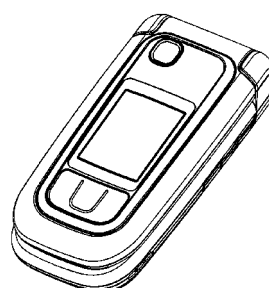
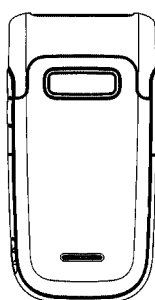
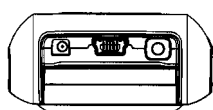
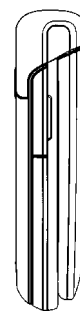
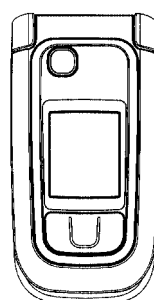
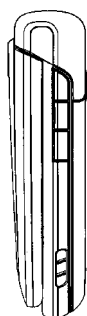
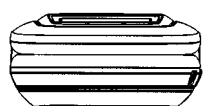

(11) Registreeringu number	01390	(51) Klass: 13-03, 08-08
(21) Taotluse number	D200700096	
(15) Registreerimise päev	15.05.2008	
(22) Esitamise päev	26.11.2007	
(24) Registreeringu kehtivuse alguse päev	26.11.2007	
(18) Registreeringu kehtivuse lõppemise päev	26.11.2012	
(28) Variantide arv	1	
(30) Prioriteediandmed	M20070101, 25.05.2007, FI	
(72) Autor	Osmo Knuutila, Tammisspaltantie 46, 20300 Turku, FI	
(73) Omanik	Nokia Corporation, Keilalahdentie 4, FIN-02150 Espoo, FI	
(74) Patendivolinik või ühine esindaja	Jüri Käosaar	

(54) Nimetus **Juhtmehoidel**

(55) Reproduktsoon

01390-1

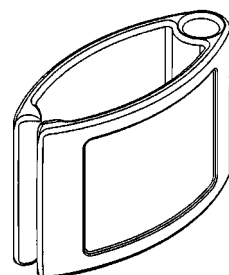
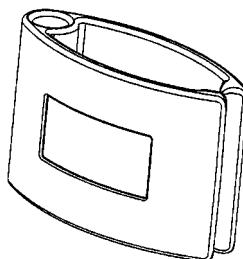
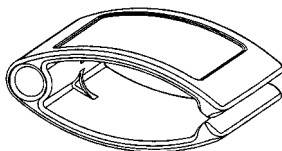
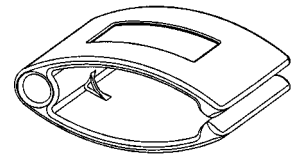
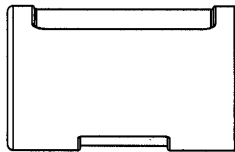
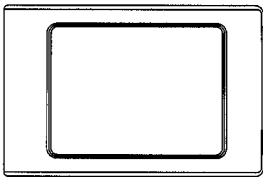
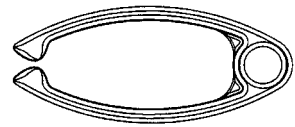
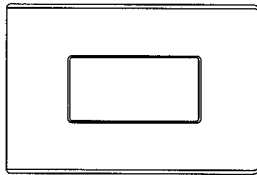
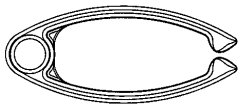

(11) Registreeringu number	01391	(51) Klass: 14-01, 14-03
(21) Taotluse number	D200700102	
(15) Registreerimise päev	15.05.2008	
(22) Esitamise päev	14.12.2007	
(24) Registreeringu kehtivuse alguse päev	14.12.2007	
(18) Registreeringu kehtivuse lõppemise päev	14.12.2012	
(28) Variantide arv	1	
(30) Prioriteediandmed	M20070118, 14.06.2007, FI	
(72) Autor	Simon Bradford, 17 York road, Teddigton, Middlesex TW11 8SL, GB Sami Lehtovaara, Suovasentie 52, 21250 Masku, FI	
(73) Omanik	Nokia Corporation, Keilalahdentie 4, FIN-02150 Espoo, FI	
(74) Patendivolinik või ühine esindaja	Jüri Käosaar	

(54) **Nimetus** **Peakomplekt**

(55) **Reproduktsoon**

01391-1

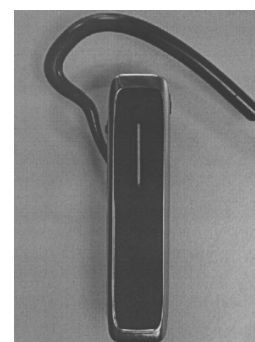
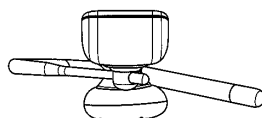
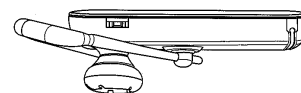
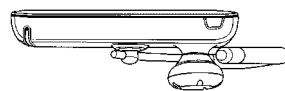
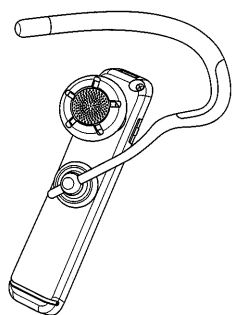
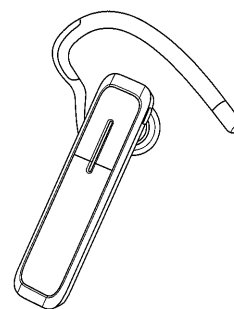
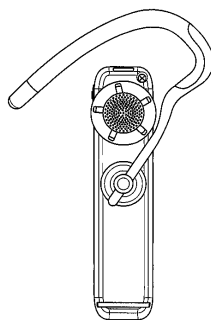
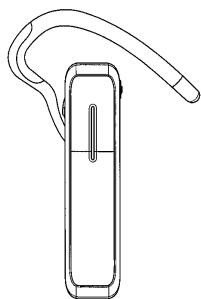

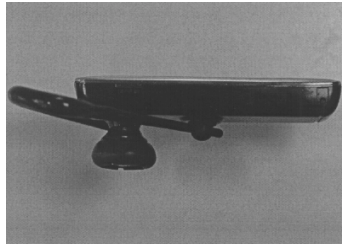
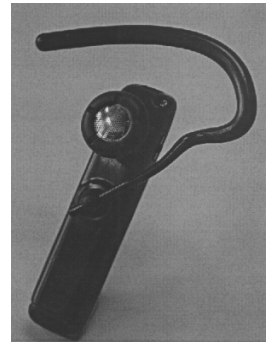

- (11) **Registreeringu number** **01392**
- (21) **Taotluse number** D200700102A
- (15) **Registreerimise päev** 15.05.2008
- (22) **Esitamise päev** 14.12.2007
- (24) **Registreeringu kehtivuse alguse päev** 14.12.2007
- (18) **Registreeringu kehtivuse lõppemise päev** 14.12.2012
- (28) **Variantide arv** 2
- (30) **Prioriteediandmed** M20070118, 14.06.2007, FI
- (72) **Autor** Simon Bradford, 17 York road, Teddington, Middlesex TW11 8SL, GB
Sami Lehtovaara, Suovasentie 52, 21250 Masku, FI
- (73) **Omanik** Nokia Corporation, Keilalahdentie 4, FIN-02150 Espoo, FI
- (74) **Patendivolinik või ühine esindaja** Jüri Käosaar

(51) Klass: **14-01, 14-03**(54) **Nimetus** **Peakomplekt**(55) **Reproduktsoon**

01392-1

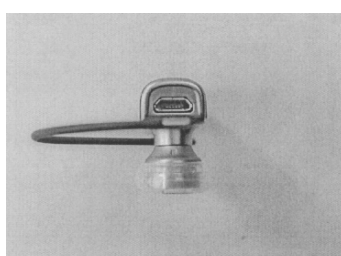
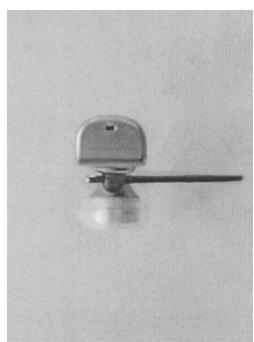
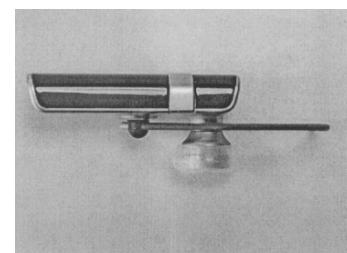
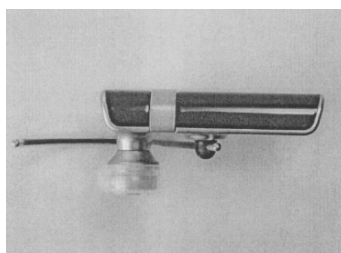
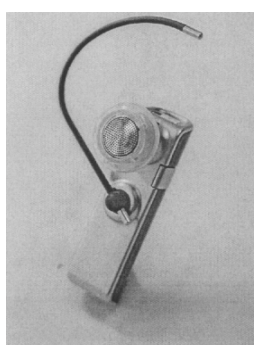
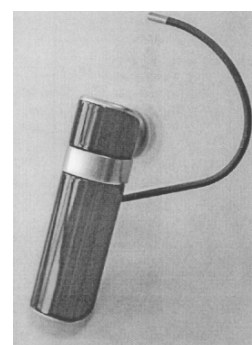
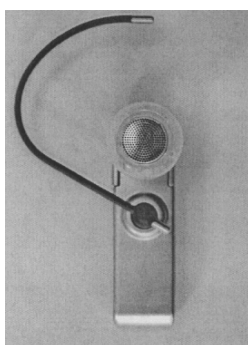
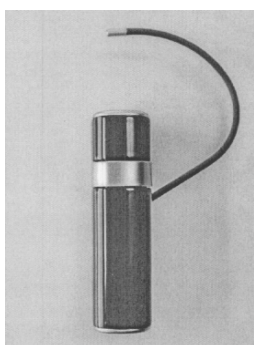

01392-2

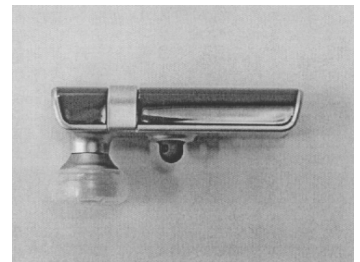
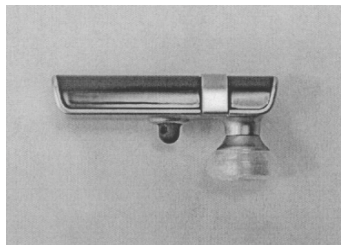
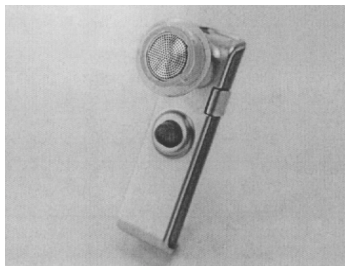
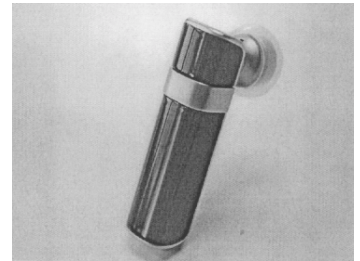
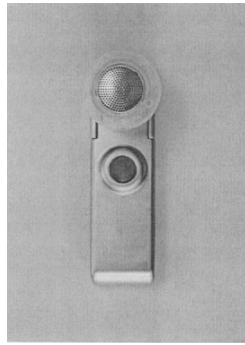
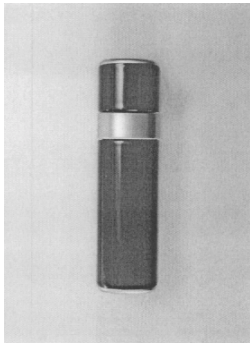

(11) Registreeringu number	01393	(51) Klass: 14-03
(21) Taotluse number	D200700103	
(15) Registreerimise päev	15.05.2008	
(22) Esitamise päev	14.12.2007	
(24) Registreeringu kehtivuse alguse päev	14.12.2007	
(18) Registreeringu kehtivuse lõppemise päev	14.12.2012	
(28) Variantide arv	1	
(30) Prioriteediandmed	M20070117, 14.06.2007, FI	
(72) Autor	Lee Irvine, The Appleloft, Punchbowl Farm, Thursley, Surrey GU8 6QJ, GB Damian Mycroft, 8 Chestnut Sq, Warwick CV35 9QR, GB	
(73) Omanik	Nokia Corporation, Keilalahdentie 4, FIN-02150 Espoo, FI	
(74) Patendivolinik või ühine esindaja	Jüri Käosaar	

(54) Nimetus **Käsitelefon**

(55) Reproduktsoon

01393-1

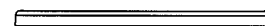
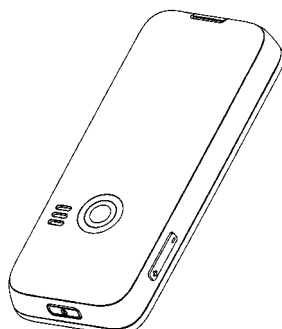
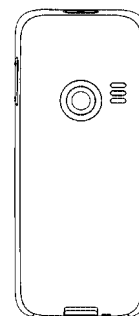
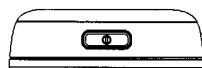
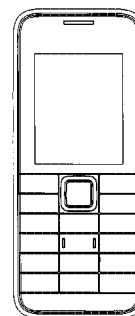
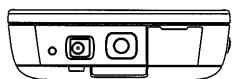

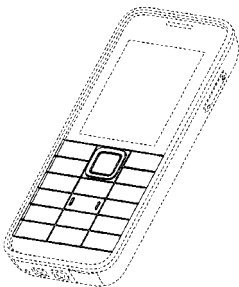
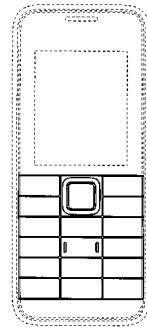
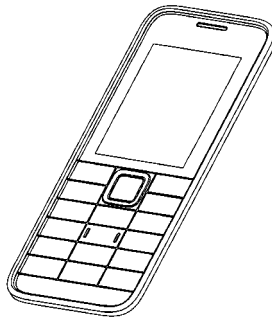
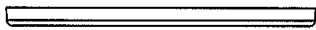
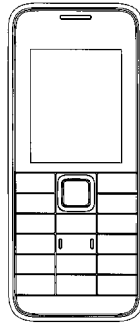

- (11) **Registreeringu number** **01394**
- (21) **Taotluse number** D200700104
- (15) **Registreerimise päev** 15.05.2008
- (22) **Esitamise päev** 20.12.2007
- (24) **Registreeringu kehtivuse alguse päev** 20.12.2007
- (18) **Registreeringu kehtivuse lõppemise päev** 20.12.2012
- (28) **Variantide arv** 1
- (30) **Prioriteediandmed** 29/281,278, 20.06.2007, US
- (72) **Autor** Frank Nuovo, 1612 Stradella Road, Los Angeles, CA 90077, US
- (73) **Omanik** Nokia Corporation, Keilalahdentie 4, FIN-02150 Espoo, FI
- (74) **Patendivolinik või ühine esindaja** Jüri Käosaar

(51) Klass: 14-03

(54) **Nimetus** **Käsitelefoni esipaneel**(55) **Reproduktsoon**

01394-1

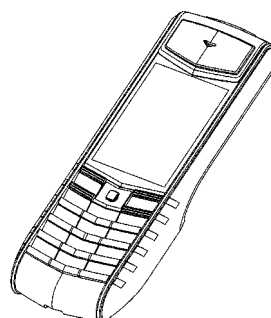
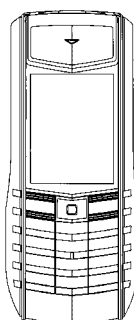
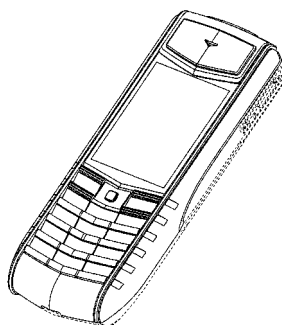
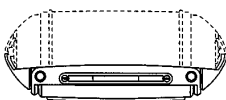
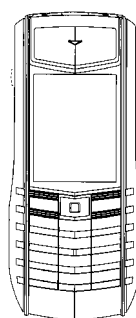
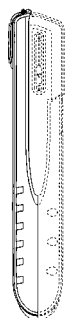
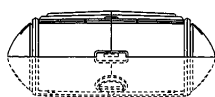

(11) Registreeringu number	01395	(51) Klass: 14-03
(21) Taotluse number	D200700105	
(15) Registreerimise päev	15.05.2008	
(22) Esitamise päev	20.12.2007	
(24) Registreeringu kehtivuse alguse päev	20.12.2007	
(18) Registreeringu kehtivuse lõppemise päev	20.12.2012	
(28) Variantide arv	1	
(30) Prioriteediandmed	29/281,278, 20.06.2007, US	
(72) Autor	Frank Nuovo, 1612 Stradella Road, Los Angeles, CA 90077, US	
(73) Omanik	Nokia Corporation, Keilalahdentie 4, FIN-02150 Espoo, FI	
(74) Patendivolinik või ühine esindaja	Jüri Käosaar	

(54) Nimetus **Käsitelefoni osa**

(55) Reproduktioon

01395-1

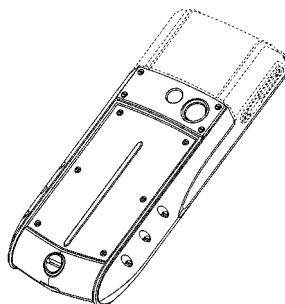
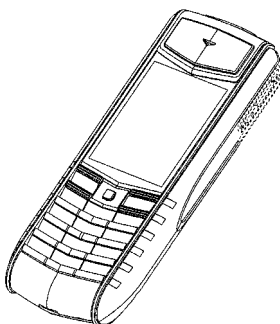
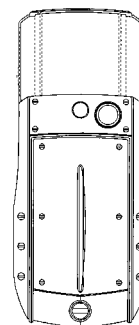
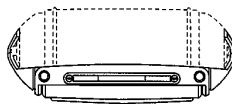
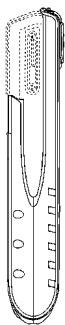
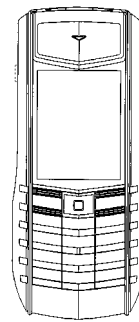
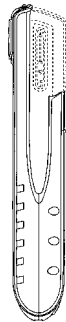
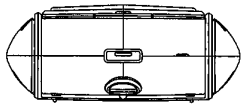

- (11) **Registreeringu number** **01396** (51) Klass: **14-03**
- (21) **Taotluse number** D200700106
- (15) **Registreerimise päev** 15.05.2008
- (22) **Esitamise päev** 20.12.2007
- (24) **Registreeringu kehtivuse alguse päev** 20.12.2007
- (18) **Registreeringu kehtivuse lõppemise päev** 20.12.2012
- (28) **Variantide arv** 1
- (30) **Prioriteediandmed** M20070121, 20.06.2007, FI
- (72) **Autor** Luke Miles, 32 Hillcrest Road, Acton, London W39RY, GB
Rachael Sleight, Flat 3, 20 Darwin Street, London SE17 1HB, GB
- (73) **Omanik** Nokia Corporation, Keilalahdentie 4, FIN-02150 Espoo, FI
- (74) **Patendivolinik või ühine esindaja** Jüri Käosaar
- (54) **Nimetus** **Käsitelefon (ainult suletud asend)**
- (55) **Reproduktsoon**

01396-1

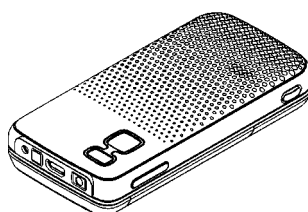
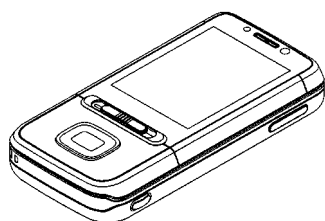
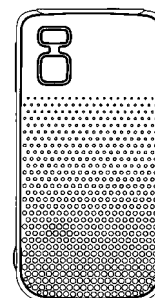
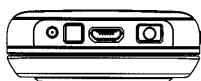
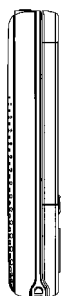
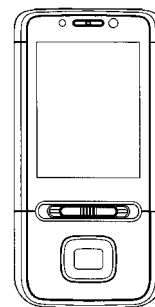
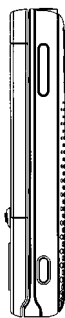

(11) Registreeringu number	01397	(51) Klass: 14-03
(21) Taotluse number	D200700107	
(15) Registreerimise päev	15.05.2008	
(22) Esitamise päev	20.12.2007	
(24) Registreeringu kehtivuse alguse päev	20.12.2007	
(18) Registreeringu kehtivuse lõppemise päev	20.12.2012	
(28) Variantide arv	1	
(30) Prioriteediandmed	M20070121, 20.06.2007, FI	
(72) Autor	Luke Miles, 32 Hillcrest Road, Acton, London W39RY, GB Rachael Sleight, Flat 3, 20 Darwin Street, London SE17 1HB, GB	
(73) Omanik	Nokia Corporation, Keilalahdentie 4, FIN-02150 Espoo, FI	
(74) Patendivolinik või ühine esindaja	Jüri Käosaar	

(54) Nimetus **Käsitelefon (avatud ja suletud asend)**

(55) Reproduktioon

01397-1

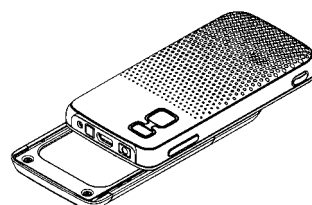
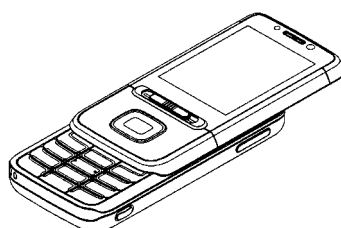
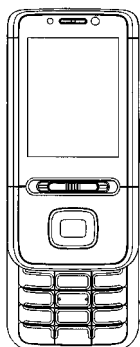
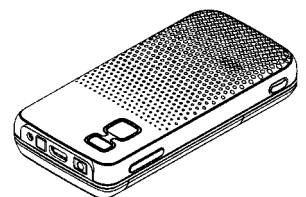
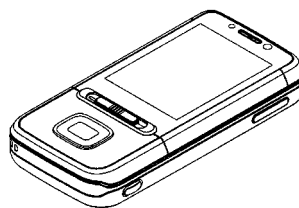
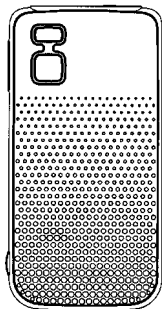
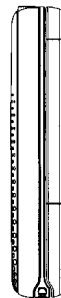
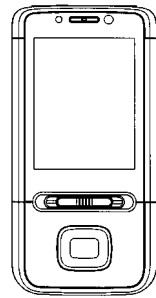

(11) Registreeringu number	01398	(51) Klass: 14-03
(21) Taotluse number	D200700108	
(15) Registreerimise päev	15.05.2008	
(22) Esitamise päev	20.12.2007	
(24) Registreeringu kehtivuse alguse päev	20.12.2007	
(18) Registreeringu kehtivuse lõppemise päev	20.12.2012	
(28) Variantide arv	1	
(30) Prioriteediandmed	M20070121, 20.06.2007, FI	
(72) Autor	Luke Miles, 32 Hillcrest Road, Acton, London W39RY, GB Rachael Sleight, Flat 3, 20 Darwin Street, London SE17 1HB, GB	
(73) Omanik	Nokia Corporation, Keilalahdentie 4, FIN-02150 Espoo, FI	
(74) Patendivolinik või ühine esindaja	Jüri Käosaar	

(54) **Nimetus** **Käsitelefoni klaviatuur**

(55) **Reproduktsoon**

01398-1

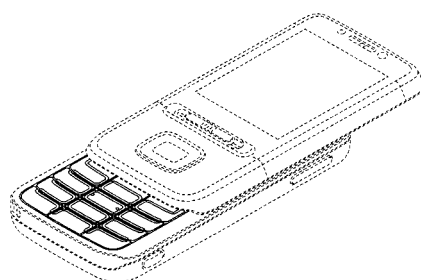
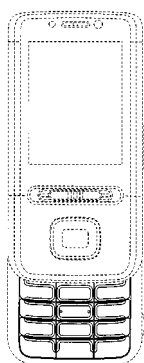

- (11) **Registreeringu number** **01399** (51) Klass: **14-03**
- (21) **Taotluse number** D200700109
- (15) **Registreerimise päev** 15.05.2008
- (22) **Esitamise päev** 20.12.2007
- (24) **Registreeringu kehtivuse alguse päev** 20.12.2007
- (18) **Registreeringu kehtivuse lõppemise päev** 20.12.2012
- (28) **Variantide arv** 1
- (30) **Prioriteediandmed** M20070121, 20.06.2007, FI
- (72) **Autor** Luke Miles, 32 Hillcrest Road, Acton, London W39RY, GB
Rachael Sleight, Flat 3, 20 Darwin Street, London SE17 1HB, GB
- (73) **Omanik** Nokia Corporation, Keilalahdentie 4, FIN-02150 Espoo, FI
- (74) **Patendivolinik või ühine esindaja** Jüri Käosaar
- (54) **Nimetus** **Käsitelefoni klahvistik**
- (55) **Reproduktsoon**

01399-1

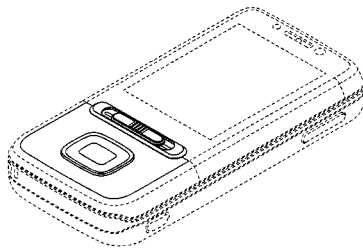
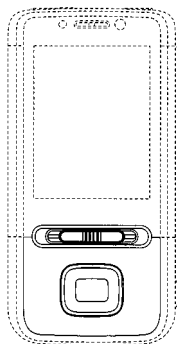

(11) Registreeringu number	01400	(51) Klass: 14-03
(21) Taotluse number	D200700110	
(15) Registreerimise päev	15.05.2008	
(22) Esitamise päev	20.12.2007	
(24) Registreeringu kehtivuse alguse päev	20.12.2007	
(18) Registreeringu kehtivuse lõppemise päev	20.12.2012	
(28) Variantide arv	1	
(30) Prioriteediandmed	M20070121, 20.06.2007, FI	
(72) Autor	Luke Miles, 32 Hillcrest Road, Acton, London W39RY, GB Rachael Sleight, Flat 3, 20 Darwin Street, London SE17 1HB, GB	
(73) Omanik	Nokia Corporation, Keilalahdentie 4, FIN-02150 Espoo, FI	
(74) Patendivolinik või ühine esindaja	Jüri Käosaar	

(54) Nimetus **Käsitelefoni esipaneel**

(55) Reproduktsoon

01400-1

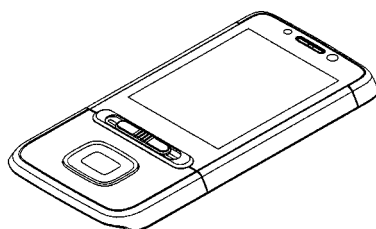
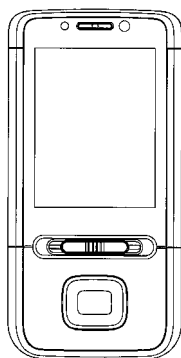

- (11) **Registreeringu number** **01401** (51) Klass: **14-03**
- (21) **Taotluse number** D200700111
- (15) **Registreerimise päev** 15.05.2008
- (22) **Esitamise päev** 20.12.2007
- (24) **Registreeringu kehtivuse alguse päev** 20.12.2007
- (18) **Registreeringu kehtivuse lõppemise päev** 20.12.2012
- (28) **Variantide arv** 1
- (30) **Prioriteediandmed** M20070121, 20.06.2007, FI
- (72) **Autor** Luke Miles, 32 Hillcrest Road, Acton, London W39RY, GB
Rachael Sleight, Flat 3, 20 Darwin Street, London SE17 1HB, GB
- (73) **Omanik** Nokia Corporation, Keilalahdentie 4, FIN-02150 Espoo, FI
- (74) **Patendivolinik või ühine esindaja** Jüri Käosaar
- (54) **Nimetus** **Käsitelefoni klahv**
- (55) **Reproduktsoon**

01401-1

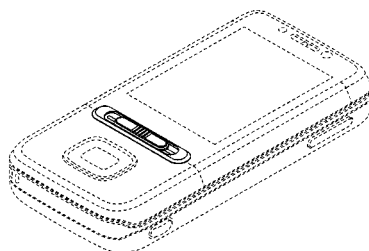
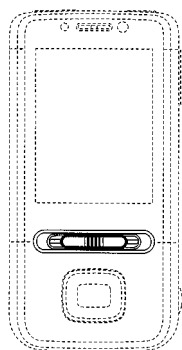

(11) Registreeringu number	01402	(51) Klass: 14-03
(21) Taotluse number	D200700112	
(15) Registreerimise päev	15.05.2008	
(22) Esitamise päev	20.12.2007	
(24) Registreeringu kehtivuse alguse päev	20.12.2007	
(18) Registreeringu kehtivuse lõppemise päev	20.12.2012	
(28) Variantide arv	1	
(30) Prioriteediandmed	M20070120, 20.06.2007, FI	
(72) Autor	Adam Stone, Flat 29, Benyon Wharf, 295 Kingsland Road, Hackney E8 4DQ, GB	
(73) Omanik	Nokia Corporation, Keilalahdentie 4, FIN-02150 Espoo, FI	
(74) Patendivolinik või ühine esindaja	Jüri Käosaar	

(54) Nimetus **Käsitelefon**

(55) Reproduktsoon

01402-1

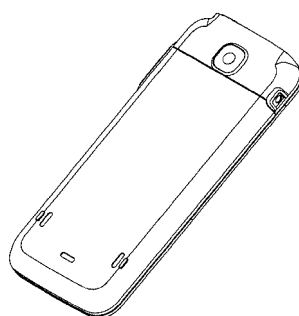
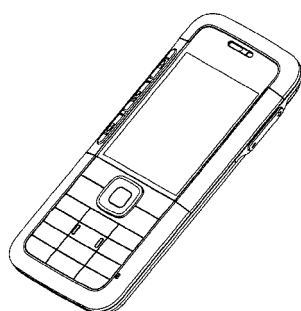
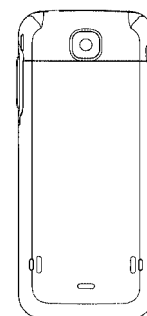
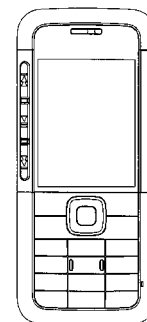

- (11) **Registreeringu number** **01403** (51) Klass: **14-03**
- (21) **Taotluse number** D200700113
- (15) **Registreerimise päev** 15.05.2008
- (22) **Esitamise päev** 20.12.2007
- (24) **Registreeringu kehtivuse alguse päev** 20.12.2007
- (18) **Registreeringu kehtivuse lõppemise päev** 20.12.2012
- (28) **Variantide arv** 1
- (30) **Prioriteediandmed** M20070121, 20.06.2007, FI
- (72) **Autor** Luke Miles, 32 Hillcrest Road, Acton, London W39RY, GB
Rachael Sleight, Flat 3, 20 Darwin Street, London SE17 1HB, GB
- (73) **Omanik** Nokia Corporation, Keilalahdentie 4, FIN-02150 Espoo, FI
- (74) **Patendivolinik või ühine esindaja** Jüri Käosaar
- (54) **Nimetus** **Käsitelefoni esipaneel ja klaviatuur**
- (55) **Reproduktsoon**

01403-1

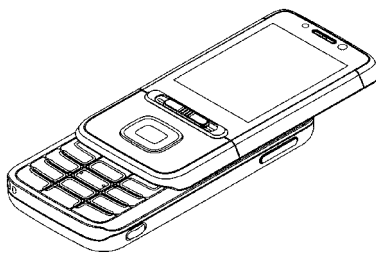
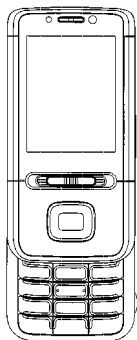

(11) Registreeringu number	01404	(51) Klass: 14-03
(21) Taotluse number	D200700114	
(15) Registreerimise päev	15.05.2008	
(22) Esitamise päev	20.12.2007	
(24) Registreeringu kehtivuse alguse päev	20.12.2007	
(18) Registreeringu kehtivuse lõppemise päev	20.12.2012	
(28) Variantide arv	1	
(30) Prioriteediandmed	M20070120, 20.06.2007, FI	
(72) Autor	Adam Stone, Flat 29, Benyon Wharf, 295 Kingsland Road, Hackney E8 4DQ, GB	
(73) Omanik	Nokia Corporation, Keilalahdentie 4, FIN-02150 Espoo, FI	
(74) Patendivolinik või ühine esindaja	Jüri Käosaar	

(54) Nimetus **Käsitelefoni esipaneel**

(55) Reproduktsoon

01404-1

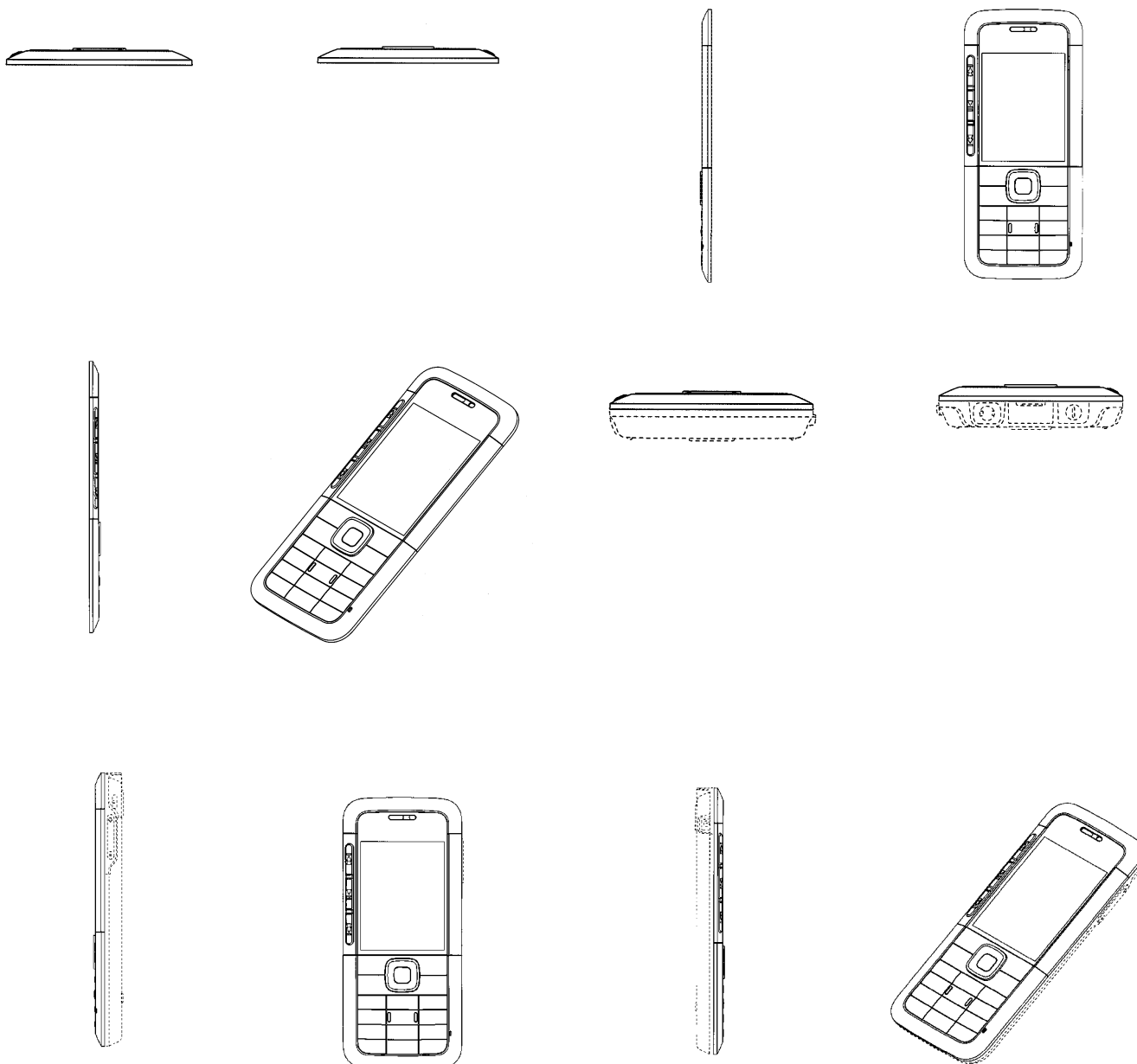

(11) Registreeringu number	01405	(51) Klass: 14-03
(21) Taotluse number	D200700115	
(15) Registreerimise päev	15.05.2008	
(22) Esitamise päev	20.12.2007	
(24) Registreeringu kehtivuse alguse päev	20.12.2007	
(18) Registreeringu kehtivuse lõppemise päev	20.12.2012	
(28) Variantide arv	2	
(30) Prioriteediandmed	29/281,278, 20.06.2007, US	
(72) Autor	Frank Nuovo, 1612 Stradella Road, Los Angeles, CA 90077, US	
(73) Omanik	Nokia Corporation, Keilalahdentie 4, FIN-02150 Espoo, FI	
(74) Patendivolinik või ühine esindaja	Jüri Käosaar	

(54) **Nimetus** **Käsitelefoni klaviatuur**

(55) **Reproduktsoon**

01405-1

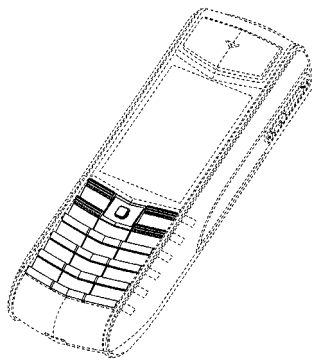
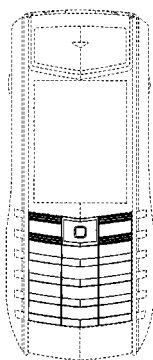

01405-2

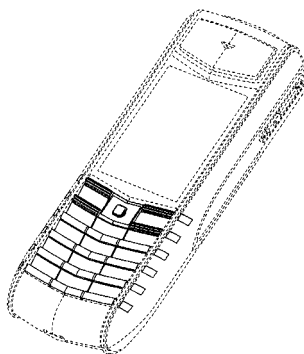
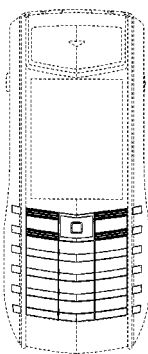

- (11) **Registreeringu number** **01406**
- (21) **Taotluse number** D200700116
- (15) **Registreerimise päev** 15.05.2008
- (22) **Esitamise päev** 20.12.2007
- (24) **Registreeringu kehtivuse alguse päev** 20.12.2007
- (18) **Registreeringu kehtivuse lõppemise päev** 20.12.2012
- (28) **Variantide arv** 1
- (30) **Prioriteediandmed** 29/281,278, 20.06.2007, US
- (72) **Autor** Frank Nuovo, 1612 Stradella Road, Los Angeles, CA 90077, US
- (73) **Omanik** Nokia Corporation, Keilalahdentie 4, FIN-02150 Espoo, FI
- (74) **Patendivolinik või ühine esindaja** Jüri Käosaar

(51) Klass: **14-03**

(54) **Nimetus** **Käsitelefon**

(55) **Reproduktsoon**

01406-1

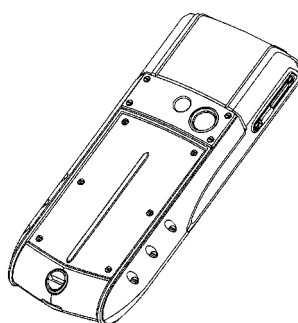
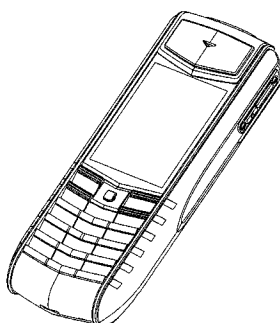
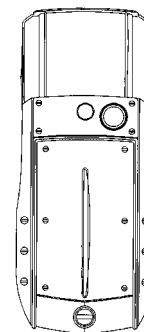
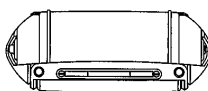
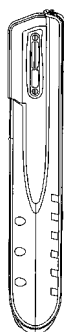
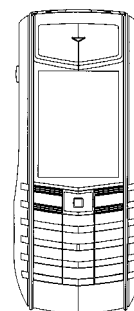
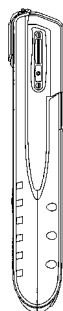
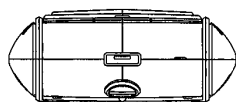

(11) Registreeringu number	01407	(51) Klass: 14-03
(21) Taotluse number	D200700117	
(15) Registreerimise päev	15.05.2008	
(22) Esitamise päev	20.12.2007	
(24) Registreeringu kehtivuse alguse päev	20.12.2007	
(18) Registreeringu kehtivuse lõppemise päev	20.12.2012	
(28) Variantide arv	1	
(30) Prioriteediandmed	M20070120, 20.06.2007, FI	
(72) Autor	Adam Stone, Flat 29, Benyon Wharf, 295 Kingsland Road, Hackney E8 4DQ, GB	
(73) Omanik	Nokia Corporation, Keilalahdentie 4, FIN-02150 Espoo, FI	
(74) Patendivolinik või ühine esindaja	Jüri Käosaar	

(54) **Nimetus** **Käsitelefoni klaviatuur**

(55) **Reproduktsoon**

01407-1

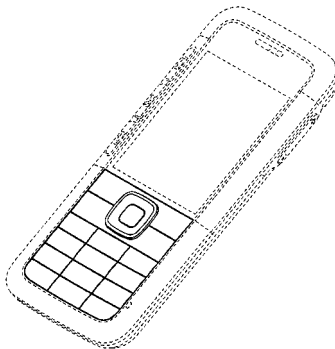
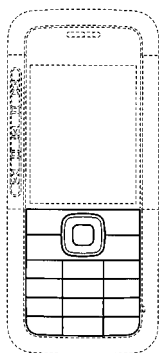

- (11) **Registreeringu number** **01408** (51) Klass: **14-03, 14-99**
- (21) **Taotluse number** D200800001
- (15) **Registreerimise päev** 15.05.2008
- (22) **Esitamise päev** 04.01.2008
- (24) **Registreeringu kehtivuse alguse päev** 04.01.2008
- (18) **Registreeringu kehtivuse lõppemise päev** 04.01.2013
- (28) **Variantide arv** 1
- (30) **Prioriteediandmed** M20070132, 04.07.2007, FI
- (72) **Autor** Jan Kettula, Leppävaarankatu 17 E 30, 02600 Espoo, FI
Mika Moilanen, c/o Nokia Corporation, Keilalahdentie 4, FIN-02150 Espoo, FI
Sami Lehtovaara, Suovasantie 52, 21250 Masku, FI
- (73) **Omanik** Nokia Corporation, Keilalahdentie 4, FIN-02150 Espoo, FI
- (74) **Patendivolinik või ühine esindaja** Kalev Käosaar

(54) **Nimetus** **Käsitelefoni hoidel**

(55) **Reproduktsoon**

01408-1

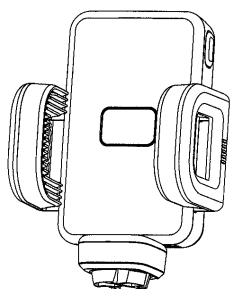
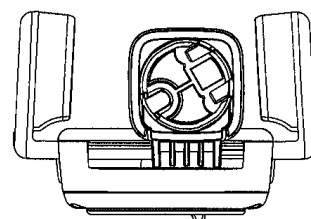
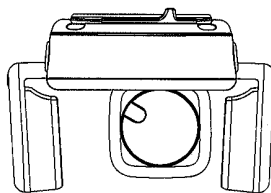
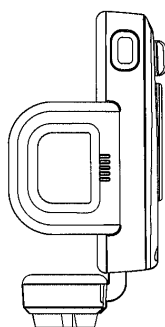
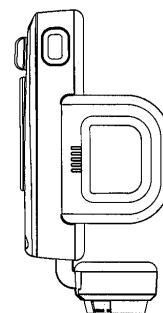
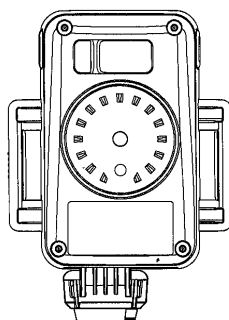
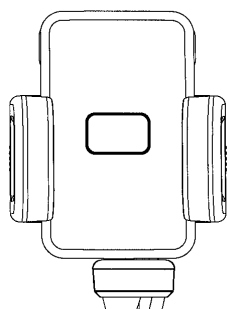

(11) Registreeringu number	01409	(51) Klass: 09-03
(21) Taotluse number	D200800003	
(15) Registreerimise päev	15.05.2008	
(22) Esitamise päev	07.01.2008	
(24) Registreeringu kehtivuse alguse päev	07.01.2008	
(18) Registreeringu kehtivuse lõppemise päev	07.01.2013	
(28) Variantide arv	1	
(30) Prioriteediandmed	M20070135, 06.07.2007, FI	
(72) Autor	Hanna Lukka, c/o Nokia Corporation, Keilalahdentie 4, FIN-02150 Espoo, FI	
(73) Omanik	Nokia Corporation, Keilalahdentie 4, FIN-02150 Espoo, FI	
(74) Patendivolinik või ühine esindaja	Kalev Käosaar	

(54) Nimetus **Karp**

(55) Reproduktioon

01409-1

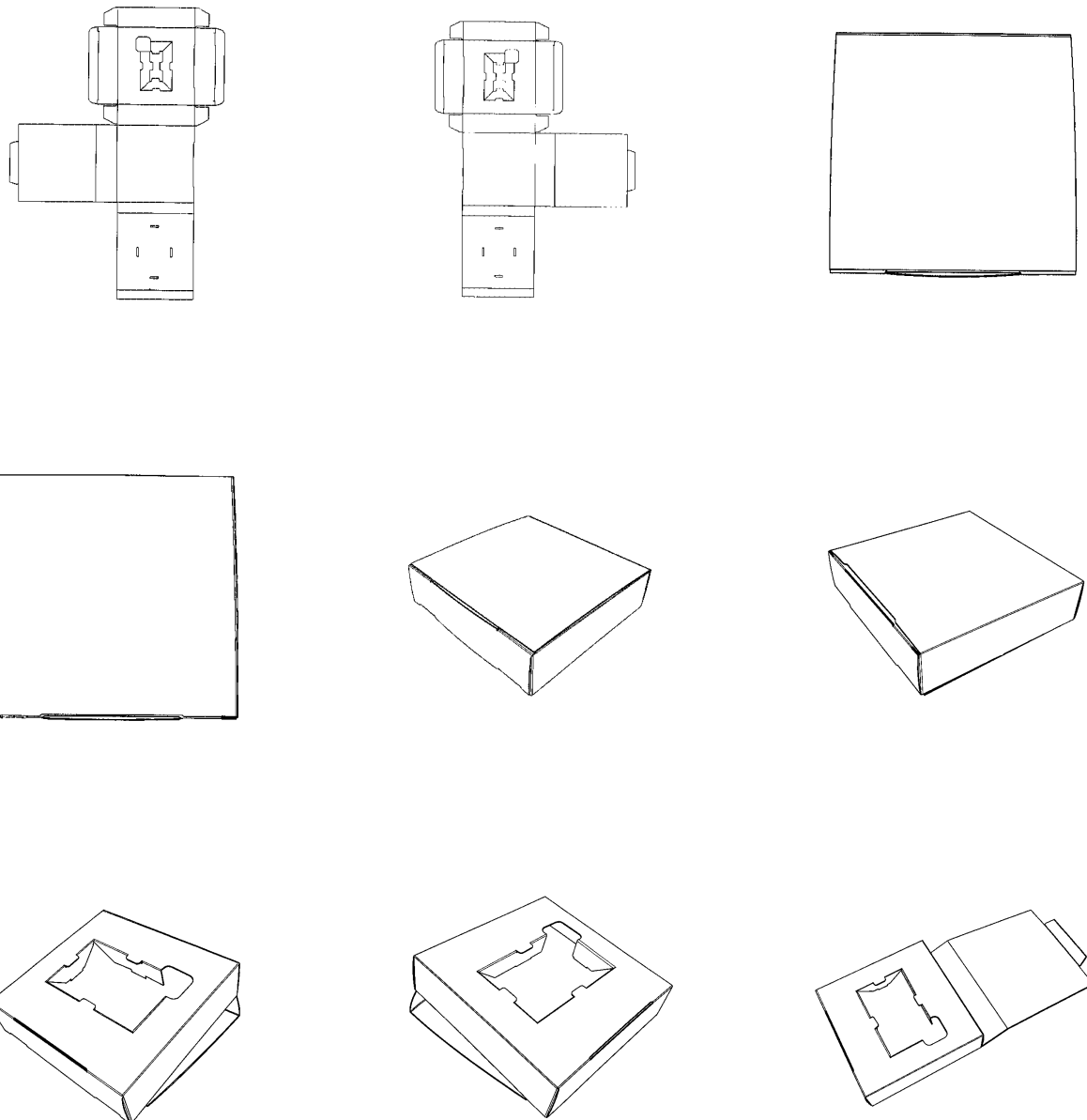

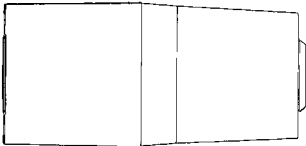
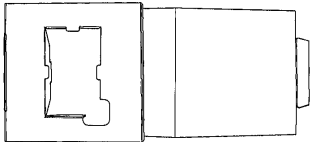
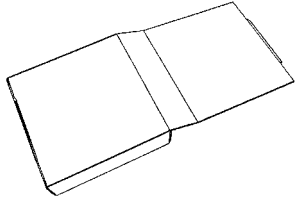
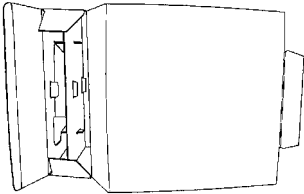
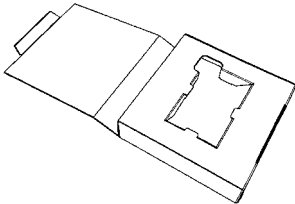

(11) Registreeringu number	01410	(51) Klass: 14-03
(21) Taotluse number	D200800004	
(15) Registreerimise päev	15.05.2008	
(22) Esitamise päev	11.01.2008	
(24) Registreeringu kehtivuse alguse päev	11.01.2008	
(18) Registreeringu kehtivuse lõppemise päev	11.01.2013	
(28) Variantide arv	1	
(30) Prioriteediandmed	29/282162, 12.07.2007, US	
(72) Autor	Justin Lyles, 12278 Scripps Summit Drive, San Diego, CA 92131, US	
(73) Omanik	Nokia Corporation, Keilalahdentie 4, FIN-02150 Espoo, FI	
(74) Patendivolinik või ühine esindaja	Jüri Käosaar	

(54) Nimetus **Käsitelefon**

(55) Reproduktioon

01410-1

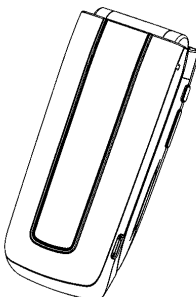
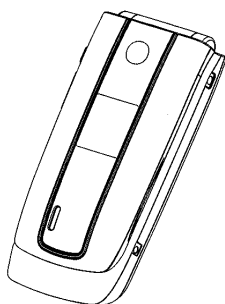
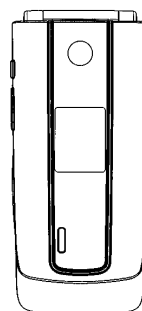
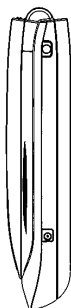
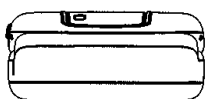

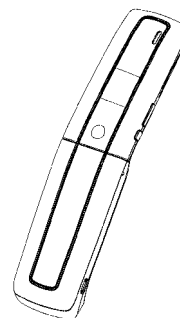
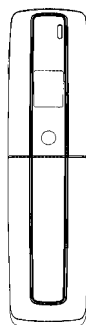
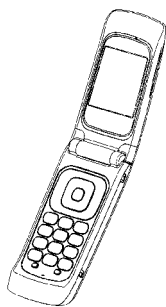

(11) **Registreeringu number**

01411

(51) Klass: **14-03**

(21) **Taotluse number**

D200800005

(15) **Registreerimise päev**

15.05.2008

(22) **Esitamise päev**

11.01.2008

(24) **Registreeringu kehtivuse
alguse päev**

11.01.2008

(18) **Registreeringu kehtivuse
lõppemise päev**

11.01.2013

(28) **Variantide arv**

1

(30) **Prioriteediandmed**

29/282162, 12.07.2007, US

(72) **Autor**

Justin Lyles, 12278 Scripps Summit Drive, San Diego, CA 92131, US

(73) **Omanik**

Nokia Corporation, Keilalahdentie 4, FIN-02150 Espoo, FI

(74) **Patendivolinik või ühine esindaja**

Jüri Käosaar

(54) **Nimetus**

Käsitelefoni klaviatuur

(55) **Reproduktsoon**

01411-1

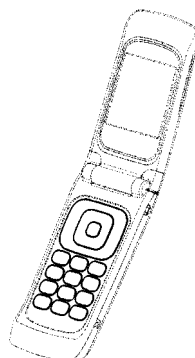
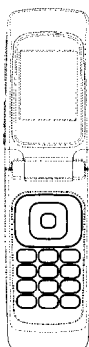

(11) Registreeringu number	01412	(51) Klass: 08-03
(21) Taotluse number	D200800007	
(15) Registreerimise päev	15.05.2008	
(22) Esitamise päev	15.01.2008	
(24) Registreeringu kehtivuse alguse päev	15.01.2008	
(18) Registreeringu kehtivuse lõppemise päev	15.01.2013	
(28) Variantide arv	1	
(30) Prioriteediandmed	D 0505105-3, 16.07.2007, ES	
(72) Autor	Josep TORRENTS I COMAS, Avda.Olimpíades, s/n., Polígono Industrial Can Roses, 08191 RUBI (Barcelona), ES	
(73) Omanik	GERMANS BOADA, S.A., Avda.Olimpíades, s/n., Polígono Industrial Can Roses, 08191 RUBI (Barcelona), ES	
(74) Patendivolinik või ühine esindaja	Jaak Ostrat	

(54) Nimetus **Keraamilise plaadi lõikur**

(55) Reproduktsoon

01412-1



- (11) **Registreeringu number** **01413** (51) Klass: **25-03**
- (21) **Taotluse number** D200800008
- (15) **Registreerimise päev** 15.05.2008
- (22) **Esitamise päev** 16.01.2008
- (24) **Registreeringu kehtivuse alguse päev** 16.01.2008
- (18) **Registreeringu kehtivuse lõppemise päev** 16.01.2013
- (28) **Variantide arv** 2
- (72) **Autor** Raul Vane, Vana-Tartu mnt 22/2, Järveküla, Rae vald, 75301 Harju maakond, EE
- (73) **Omanik** Terasvara OÜ, Salve 4c, 11612 Tallinn, EE

(54) **Nimetus** **Ootepaviljon**

(55) **Reproduktsoon**

01413-1

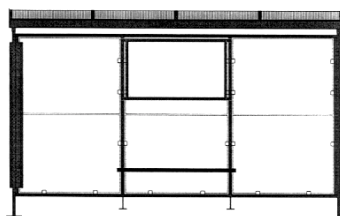
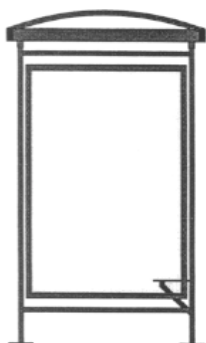

01413-2

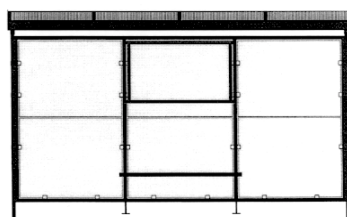
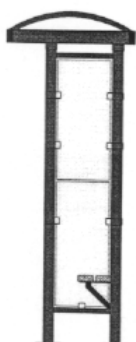

(11) Registreeringu number	01414	(51) Klass: 20-03
(21) Taotluse number	D200800009	
(15) Registreerimise päev	15.05.2008	
(22) Esitamise päev	16.01.2008	
(24) Registreeringu kehtivuse alguse päev	16.01.2008	
(18) Registreeringu kehtivuse lõppemise päev	16.01.2013	
(28) Variantide arv	2	
(72) Autor	Raul Vane, Vana-Tartu mnt 22/2, Järveküla, Rae vald, 75301 Harju maakond, EE	
(73) Omanik	Terasvara OÜ, Salve 4c, 11612 Tallinn, EE	

(54) Nimetus **Valgustatud reklaaminfotahvel**

(55) Reproduktsoon

01414-1

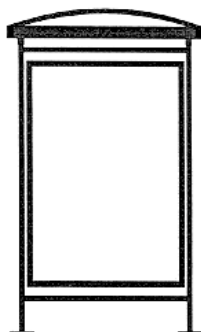

01414-2

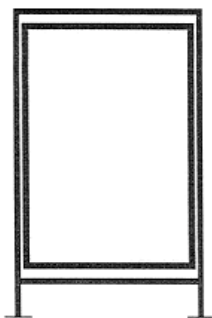

(11) **Registreeringu number** **01415**

(51) Klass: **09-03**

(21) **Taotluse number** D200800010

(15) **Registreerimise päev** 15.05.2008

(22) **Esitamise päev** 16.01.2008

(24) **Registreeringu kehtivuse alguse päev** 16.01.2008

(18) **Registreeringu kehtivuse lõppemise päev** 16.01.2013

(28) **Variantide arv** 1

(72) **Autor** Hannes Niid, Tule 5-38, Saue, 76505 Harju maakond, EE

(73) **Omanik** Hannes Niid, Tule 5-38, Saue, 76505 Harju maakond, EE

(54) **Nimetus** **Pakend**

(55) **Reproduktsoon**

01415-1



- (11) **Registreeringu number** **01416** (51) Klass: **21-01**
- (21) **Taotluse number** D200800011
- (15) **Registreerimise päev** 15.05.2008
- (22) **Esitamise päev** 04.02.2008
- (24) **Registreeringu kehtivuse alguse päev** 04.02.2008
- (18) **Registreeringu kehtivuse lõppemise päev** 04.02.2013
- (28) **Variantide arv** 1
- (72) **Autor** Raul Erdel, J. Kunderi 29-6, 10121 Tallinn, EE
- (73) **Omanik** Raul Erdel, J. Kunderi 29-6, 10121 Tallinn, EE
- (54) **Nimetus** **Mänguasi**
- (55) **Reproduktsoon**

01416-1



- (11) **Registreeringu number** **01417** (51) Klass: **14-01**
- (21) **Taotluse number** D200800012
- (15) **Registreerimise päev** 15.05.2008
- (22) **Esitamise päev** 04.02.2008
- (24) **Registreeringu kehtivuse alguse päev** 04.02.2008
- (18) **Registreeringu kehtivuse lõppemise päev** 04.02.2013
- (28) **Variantide arv** 1
- (72) **Autor** Juha Korhonen, Magasini 3-9, 51005 Tartu, EE
Veli-Pekka Korhonen, Magasini 3-5, 51005 Tartu, EE
Jyri Turunen, Magasini 3-5, 51005 Tartu, EE
- (73) **Omanik** Thorandson OÜ, Uus-Sadama 21, 10120 Tallinn, EE
- (54) **Nimetus** **Kõlar**
- (55) **Reproduktsoon**
- 01417-1



(11) Registreeringu number	01418	(51) Klass: 25-01, 25-02
(21) Taotluse number	D200800022	
(15) Registreerimise päev	15.05.2008	
(22) Esitamise päev	17.03.2008	
(24) Registreeringu kehtivuse alguse päev	17.03.2008	
(18) Registreeringu kehtivuse lõppemise päev	17.03.2013	
(28) Variantide arv	2	
(72) Autor	Raul Suurhans, Lossi 20-5, 12616 Tallinn, EE	
(73) Omanik	Prisma Meedia OÜ, Paadi 14A-51, 10151 Tallinn, EE	
(74) Patendivolinik või ühine esindaja	Jaak Ostrat	

(54) Nimetus **Profiil**

(55) Reproduktsoon

01418-1

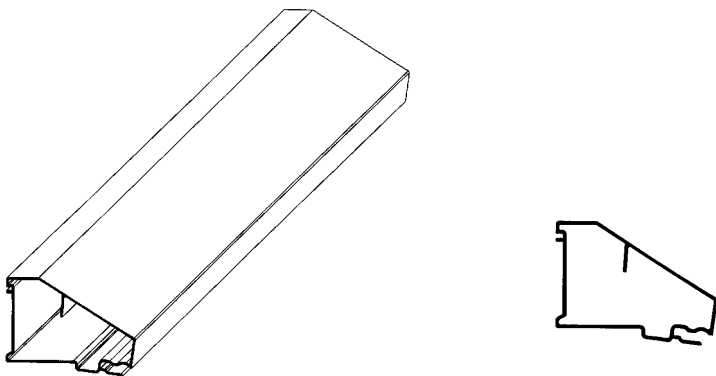

01418-2

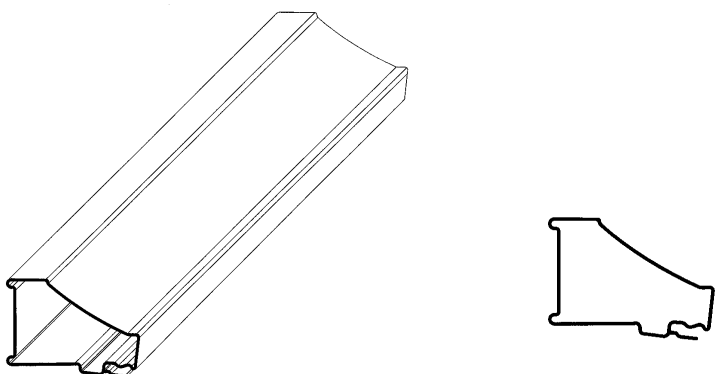

II. RAHVUSVAHELISELT REGISTREERITUD TÖÖSTUSDISAINILAHENDUSED

Avaldatakse "Tööstusdisaini kaitse seaduse" § 87⁴ lõike 3 alusel. Patendiamet ei ole kontrollinud tööstusdisainilahenduse uudsust ja eristatavust tulenevalt "Tööstusdisaini kaitse seaduse" § 31 lõike 2 punktist 1.

(11) **Rahvusvah reg nr**

DM/068573

(51) Klass: **10-07**

(21) **Rahvusvah reg jrk**

H200700044

(15) **Registreeringu päev**

14.02.2007

(28) **Variantide arv**

1

(72) **Autor**

Eddy SCHOEPFER

(73) **Omanik**

BREITLING SA, Schlachthausstrasse, 2, case postale 1132,
CH-2540 Grenchen, CH

**WIPO Rahvusvah Tööstusdisainilahenduste
Bülletääni nr, kus registreering on avaldatud**

2007/07

(55) **Reproduksioon**

DM/068573-1

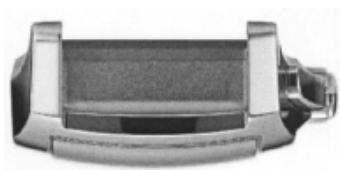
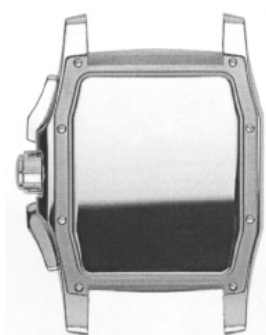
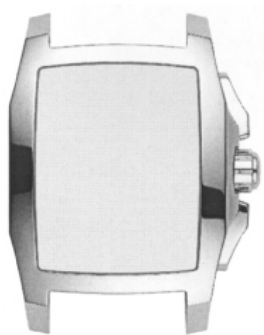

(11) **Rahvusvah reg nr**

DM/068573

(51) Klass: **10-07**

(21) **Rahvusvah reg jrk**

H200700044A

(15) **Registreeringu päev**

14.02.2007

(28) **Variantide arv**

1

(72) **Autor**

Eddy SCHOEPFER

(73) **Omanik**

BREITLING SA, Schlachthausstrasse, 2, case postale 1132,
CH-2540 Grenchen, CH

**WIPO Rahvusvah Tööstusdisainilahenduste
Bülletääni nr, kus registreering on avaldatud**

2007/07

(55) **Reproduksioon**

DM/068573-1

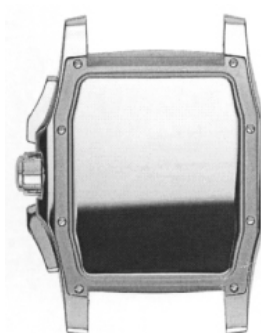

(11) **Rahvusvah reg nr**

DM/068573

(51) Klass: **10-07**

(21) **Rahvusvah reg jrk**

H200700044B

(15) **Registreeringu päev**

14.02.2007

(28) **Variantide arv**

1

(72) **Autor**

Eddy SCHOEPFER

(73) **Omanik**

BREITLING SA, Schlachthausstrasse, 2, case postale 1132,
CH-2540 Grenchen, CH

**WIPO Rahvusvah Tööstusdisainilahenduste
Bülletääni nr, kus registreering on avaldatud**

2007/07

(55) **Reproduksioon**

DM/068573-1

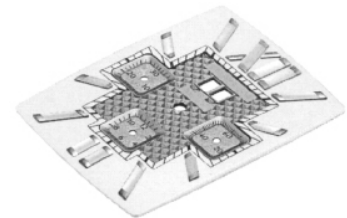
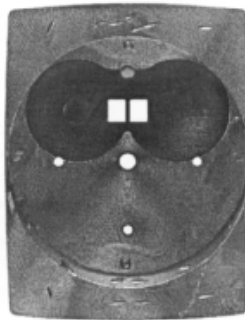
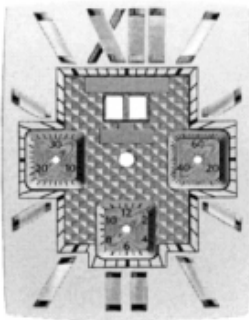

(11) Rahvusvah reg nr	DM/068624	(51) Klass: 09-09
(21) Rahvusvah reg jrk	H200700040	
(15) Registreeringu päev	28.01.2007	
(28) Variantide arv	2	
(72) Autor	Alexandra Benson	
(73) Omanik	ALEXANDRA BENSON, Rue Haldimand 8, CH-1003 Lausanne, CH	
WIPO Rahvusvah Tööstusdisainilahenduste Bülletääni nr, kus registreering on avaldatud	2007/06	

(55) **Reproduktsoon**

DM/068624-1

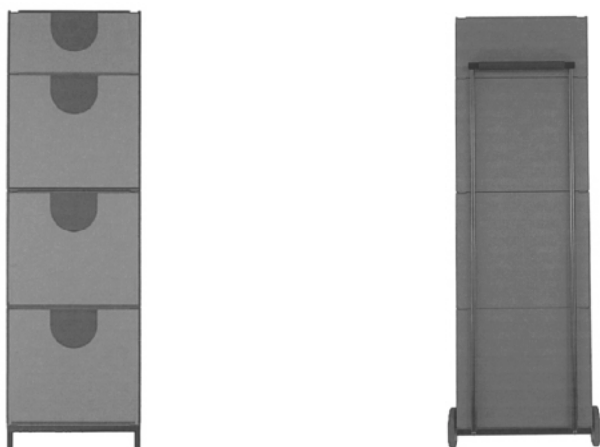

DM/068624-2

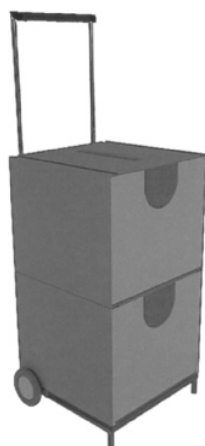

(11) **Rahvusvah reg nr**

DM/068702

(51) Klass: **10-07**

(21) **Rahvusvah reg jrk**

H200700058

(15) **Registreeringu päev**

20.03.2007

(28) **Variantide arv**

1

(72) **Autor**

Eddy SCHOEPFER

(73) **Omanik**

BREITLING SA, Schlachthausstrasse, 2 Case postale 1132,
CH-2540 Grenchen, CH

**WIPO Rahvusvah Tööstusdisainilahenduste
Bülletääni nr, kus registreering on avaldatud**

2007/8

(55) **Reproduksioon**

DM/068702-1

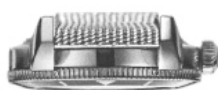

(11) **Rahvusvah reg nr**

DM/068748

(51) Klass: **27-06**

(21) **Rahvusvah reg jrk**

H200700057

(15) **Registreeringu päev**

12.03.2007

(28) **Variantide arv**

1

(72) **Autor**

Roger Nuetzi

(73) **Omanik**

Amcor Rentsch Rickenbach AG, Industriestrasse W6,
CH-4613 Rickenbach, CH

**WIPO Rahvusvah Tööstusdisainilahenduste
Bülletääni nr, kus registreering on avaldatud**

2007/8

(55) **Reproduksioon**

DM/068748-1

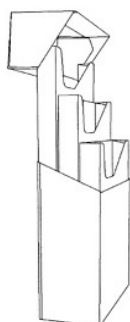
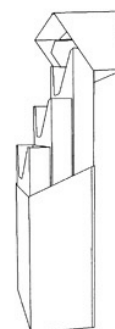
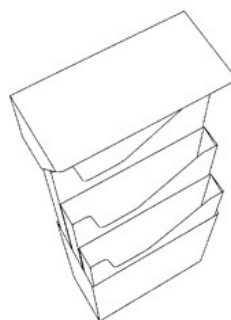
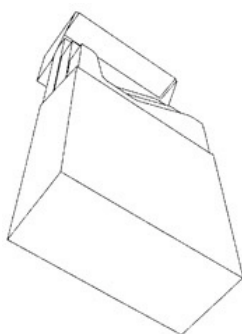
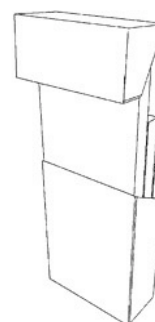
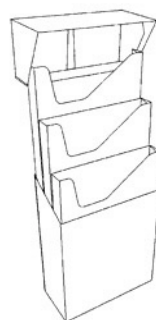
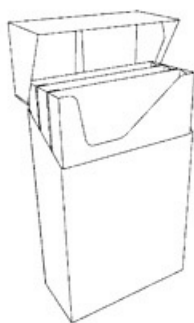

(11) **Rahvusvah reg nr**

DM/068803

(51) Klass: **10-07**

(21) **Rahvusvah reg jrk**

H200700056

(15) **Registreeringu päev**

29.03.2007

(28) **Variantide arv**

1

(72) **Autor**

Jean-Pierre Chodat

Renato Scarinzi / Maco Scarinzi

(73) **Omanik**

MGI LUXURY GROUP SA, Nidaugasse 35, CH-2502 Bienne, CH

WIPO Rahvusvah Tööstusdisainilahenduste

Bülletääni nr, kus registreering on avaldatud 2007/8

(55) **Reproduksioon**

DM/068803-1

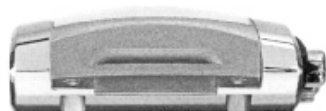
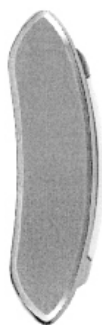
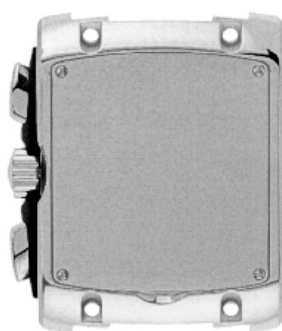

(11) Rahvusvah reg nr	DM/068803	(51) Klass: 10-07
(21) Rahvusvah reg jrk	H200700056A	
(15) Registreeringu päev	29.03.2007	
(28) Variantide arv	1	
(72) Autor	Jean-Pierre Chodat Renato Scarinzi / Maco Scarinzi	
(73) Omanik	MGI LUXURY GROUP SA, Nidaugasse 35, CH-2502 Bienne, CH	
WIPO Rahvusvah Tööstusdisainilahenduste Bülletääni nr, kus registreering on avaldatud	2007/8	

(55) **Reproduksioon**

DM/068803-1



(11) Rahvusvah reg nr	DM/068823	(51) Klass: 10-02
(21) Rahvusvah reg jrk	H200700059	
(15) Registreeringu päev	13.04.2007	
(28) Variantide arv	4	
(30) Prioriteediandmed	133286, 31.10.2006, CH	
(72) Autor	Maria Cristina CALVANI	
(73) Omanik	ROLEX SA, Rue Francois-Dussaud 3-5-7, CH-1211 Genève 26, CH	
WIPO Rahvusvah Tööstusdisainilahenduste		
Bülletääni nr, kus registreering on avaldatud	2007/09	

(55) **Reproduksioon**

DM/068823-1



DM/068823-2



DM/068823-3





DM/068823-4



(11) Rahvusvah reg nr	DM/068823	(51) Klass: 10-07
(21) Rahvusvah reg jrk	H200700059A	
(15) Registreeringu päev	13.04.2007	
(28) Variantide arv	2	
(30) Prioriteediandmed	133 286, 31.10.2006, CH	
(72) Autor	Maria Cristina CALVANI	
(73) Omanik	ROLEX SA, Rue Francois-Dussaud 3-5-7, CH-1211 Genève 26, CH	
WIPO Rahvusvah Tööstusdisainilahenduste		
Bülletääni nr, kus registreering on avaldatud	2007/09	

(55) **Reproduksioon**

DM/068823-1



DM/068823-2



(11) Rahvusvah reg nr	DM/068823	(51) Klass: 10-07
(21) Rahvusvah reg jrk	H200700059B	
(15) Registreeringu päev	13.04.2007	
(28) Variantide arv	2	
(30) Prioriteediandmed	133 286, 31.10.2006, CH	
(72) Autor	Maria Cristina CALVANI	
(73) Omanik	ROLEX SA, Rue Francois-Dussaud 3-5-7, CH-1211 Genève 26, CH	
WIPO Rahvusvah Tööstusdisainilahenduste		
Bülletääni nr, kus registreering on avaldatud	2007/09	

(55) **Reproduksioon**

DM/068823-1



DM/068823-2



(11) Rahvusvah reg nr	DM/068824	(51) Klass: 10-02
(21) Rahvusvah reg jrk	H200700060	
(15) Registreeringu päev	13.04.2007	
(28) Variantide arv	4	
(30) Prioriteediandmed	133 285, 31.10.2006, CH	
(72) Autor	Maria Cristina CALVANI	
(73) Omanik	ROLEX SA, Rue Francois-Dussaud 3-5-7, CH-1211 Genève 26, CH	
WIPO Rahvusvah Tööstusdisainilahenduste		
Bülletääni nr, kus registreering on avaldatud	2007/9	

(55) **Reproduktsoon**

DM/068824-1

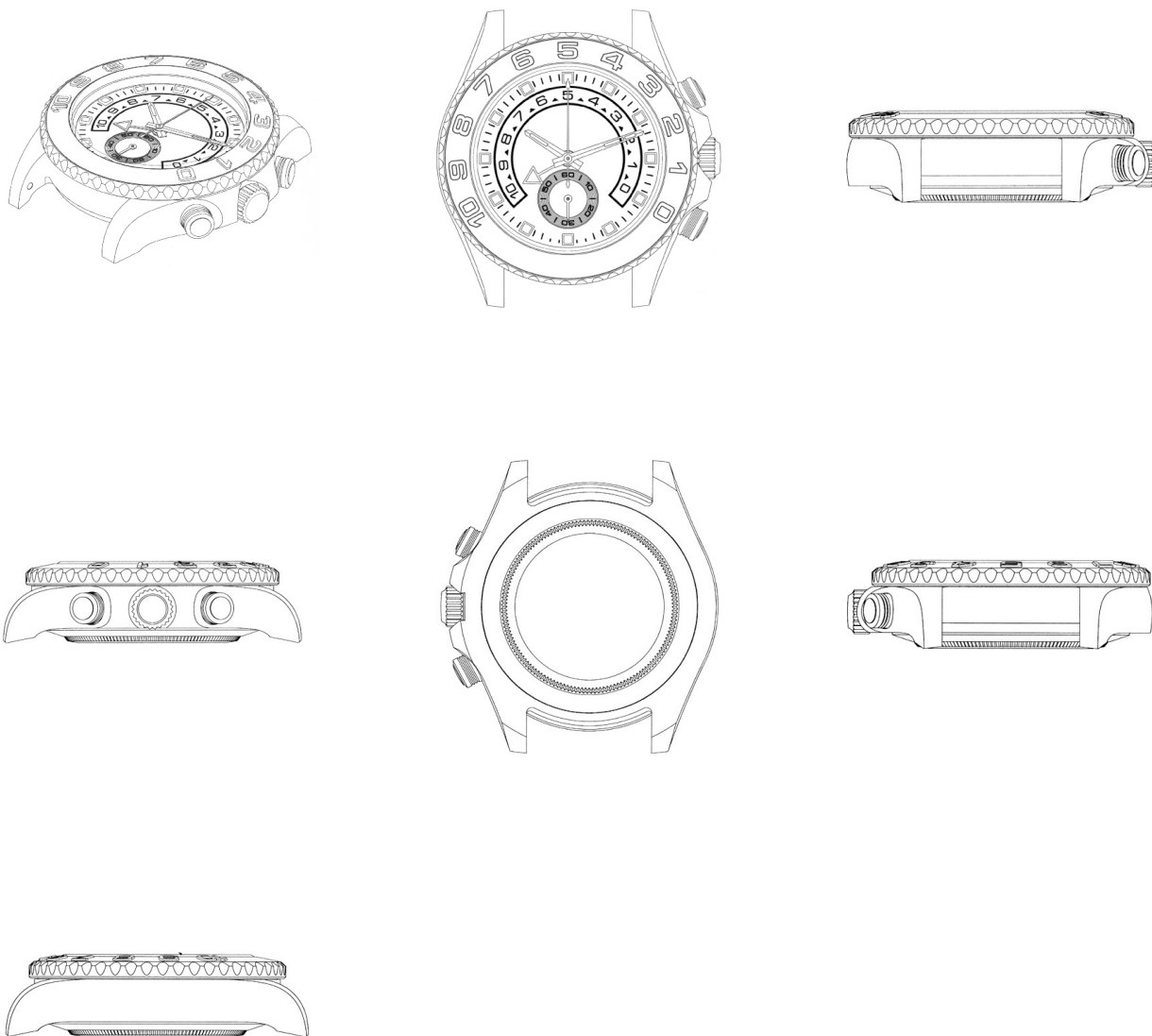

DM/068824-2

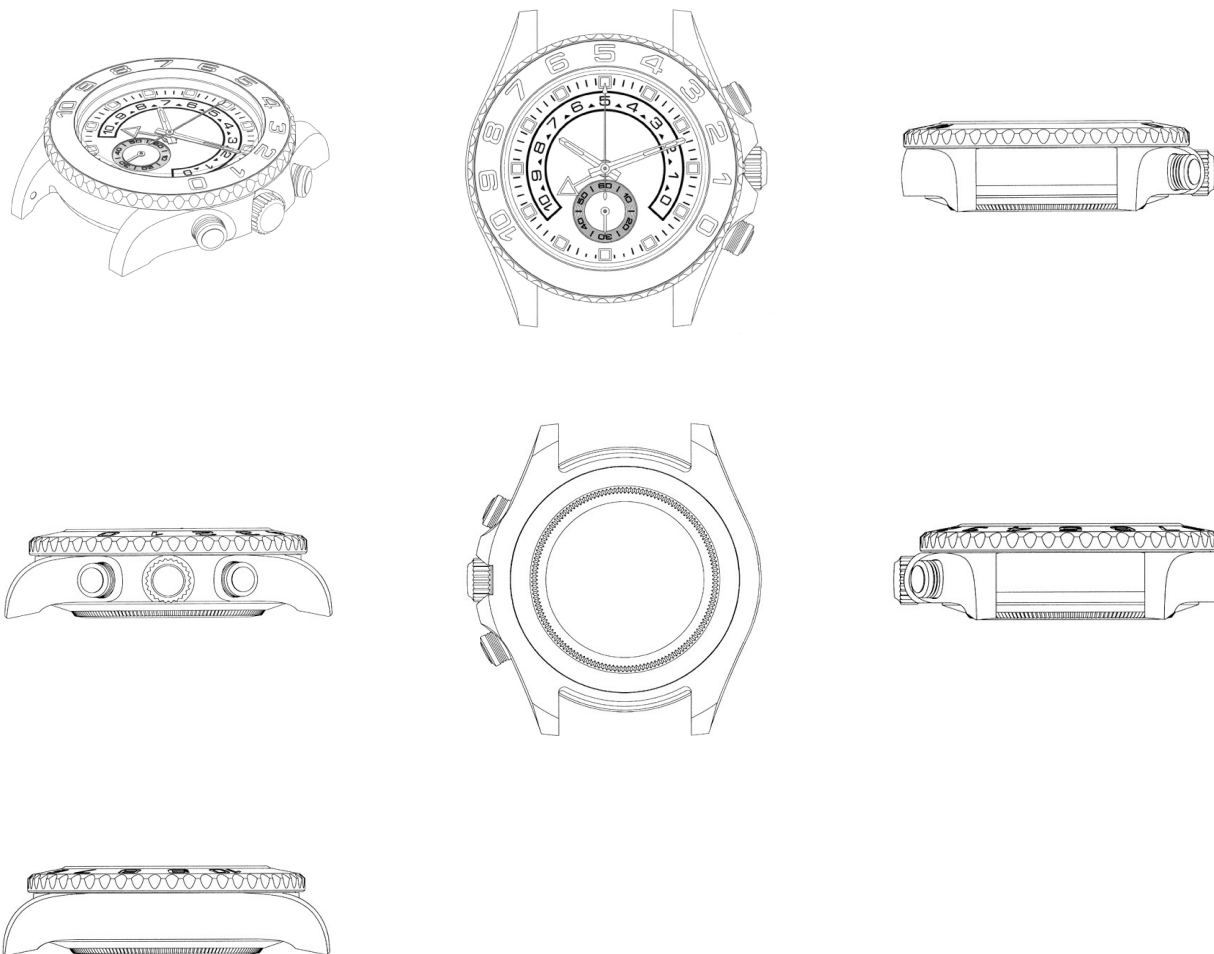

DM/068824-3

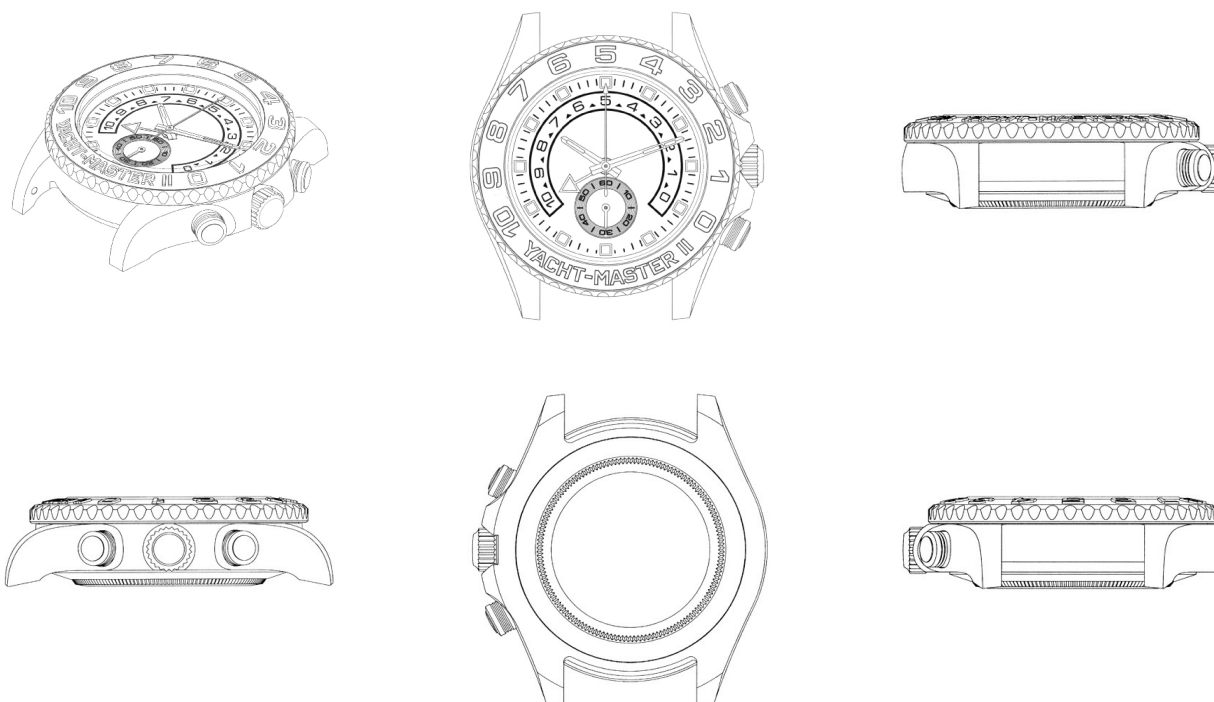

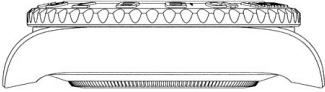

DM/068824-4

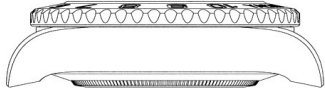
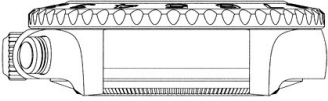
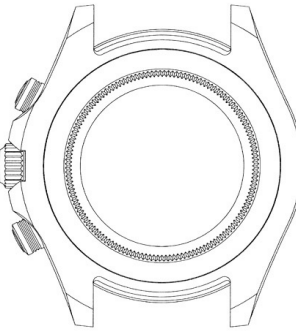
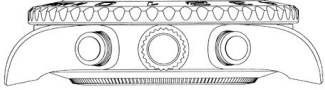
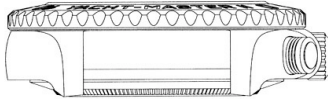

(11) **Rahvusvah reg nr****DM/068824**(51) Klass: **10-07**(21) **Rahvusvah reg jrk**

H200700060A

(15) **Registreeringu päev**

13.04.2007

(28) **Variantide arv**

4

(30) **Prioriteediandmed**

133 285, 31.10.2006, CH

(72) **Autor**

Maria Cristina CALVANI

(73) **Omanik**

ROLEX SA, Rue Francois-Dussaud 3-5-7, CH-1211 Genève 26, CH

WIPO Rahvusvah Tööstusdisainilahenduste**Bülletääni nr, kus registreering on avaldatud** 2007/09(55) **Reproduksioon**

DM/068824-1

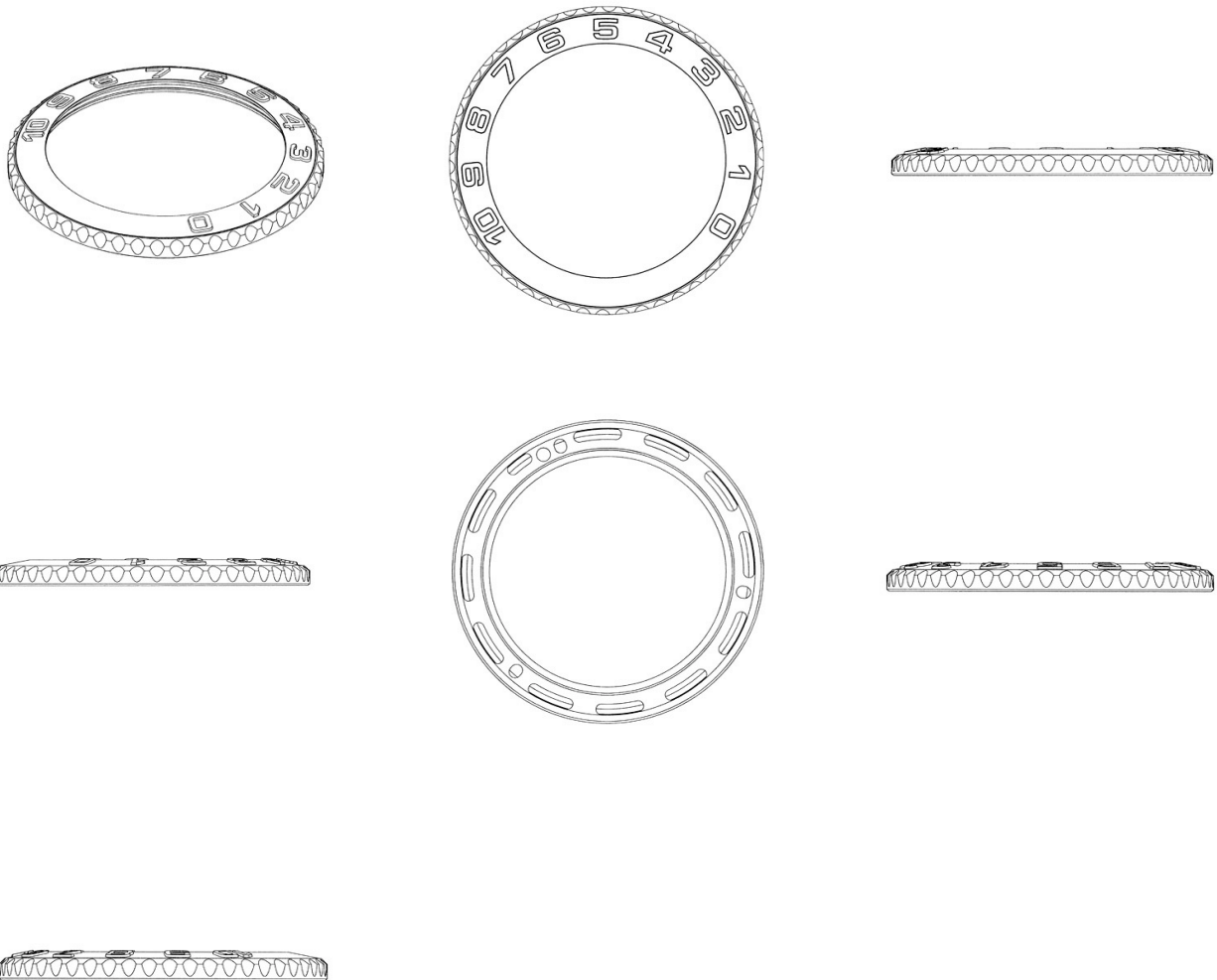

DM/068824-2

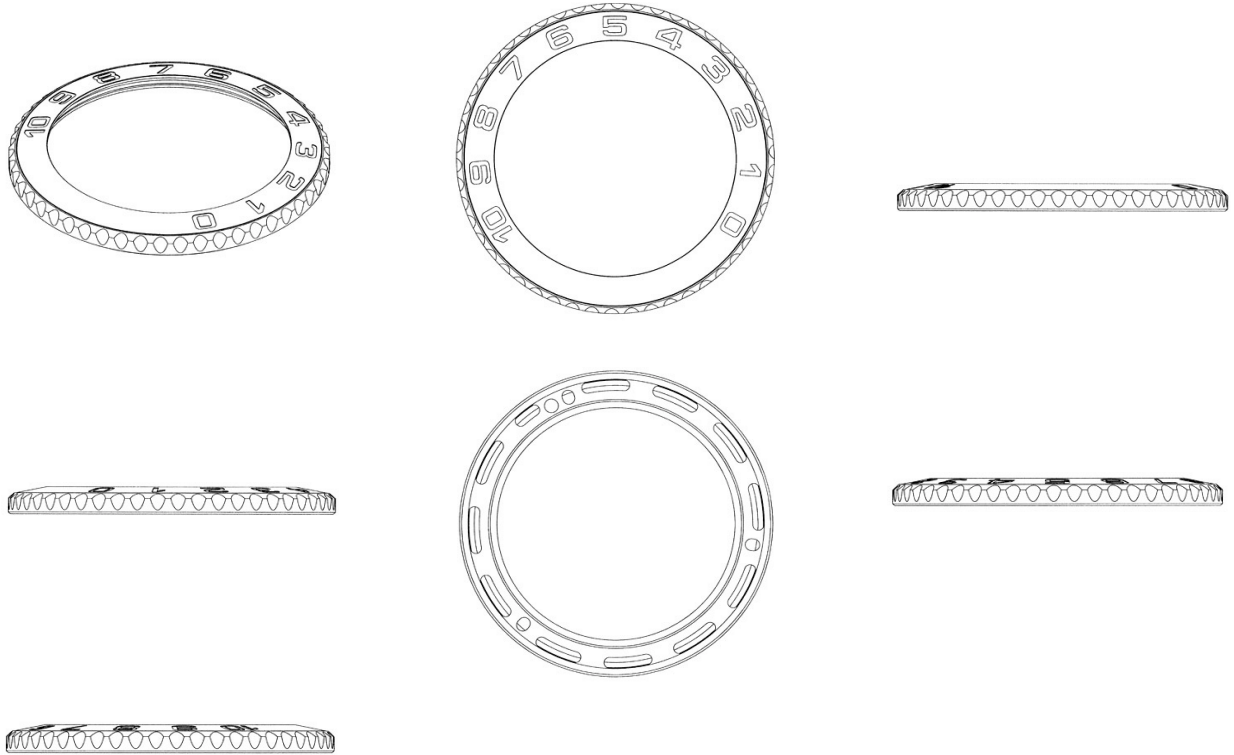

DM/068824-3

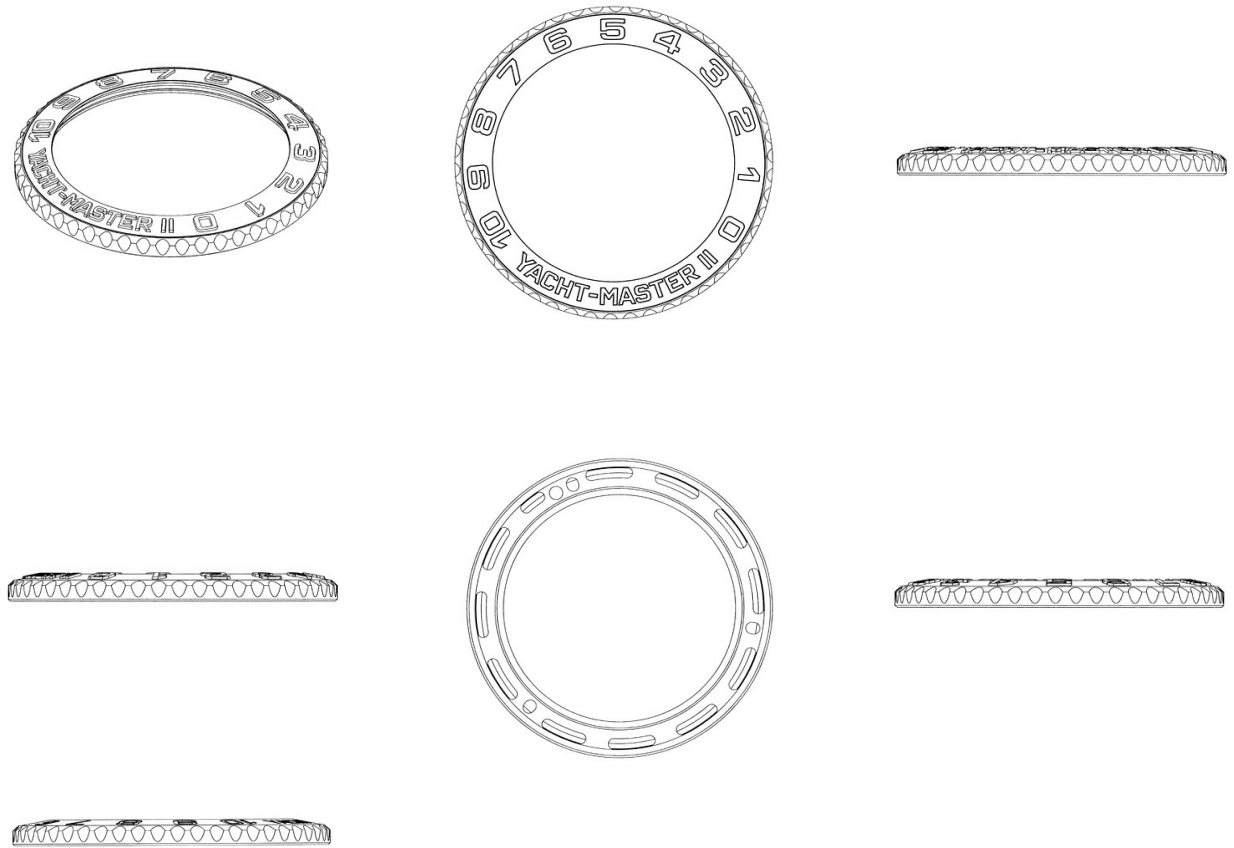

DM/068824-4

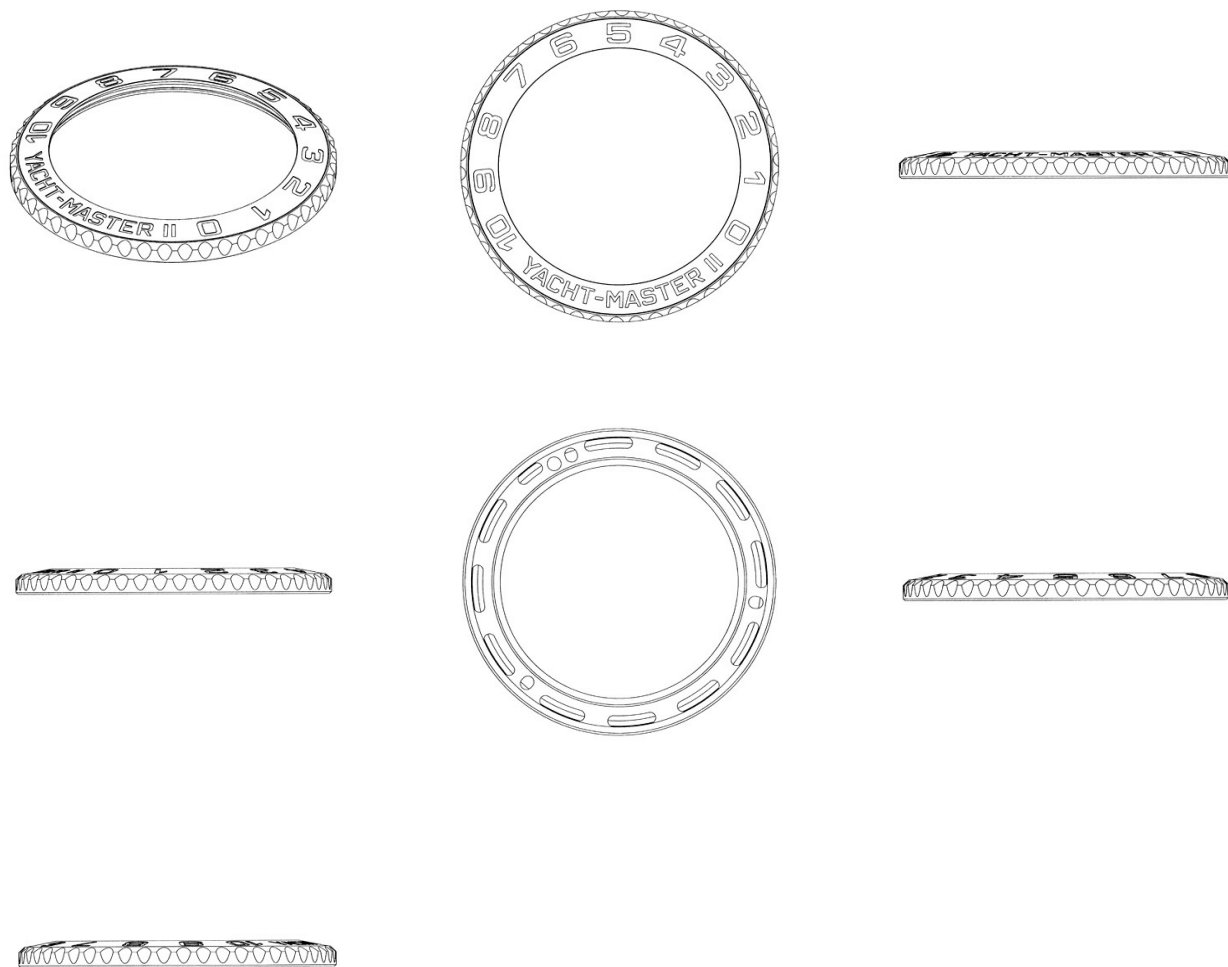

(11) Rahvusvah reg nr	DM/068824	(51) Klass: 10-07
(21) Rahvusvah reg jrk	H200700060B	
(15) Registreeringu päev	13.04.2007	
(28) Variantide arv	2	
(30) Prioriteediandmed	133 285, 31.10.2006, CH	
(72) Autor	Maria Cristina CALVANI	
(73) Omanik	ROLEX SA, Rue Francois-Dussaud 3-5-7, CH-1211 Genève 26, CH	
WIPO Rahvusvah Tööstusdisainilahenduste		
Bülletääni nr, kus registreering on avaldatud	2007/09	

(55) **Reproduktsoon**

DM/068824-1

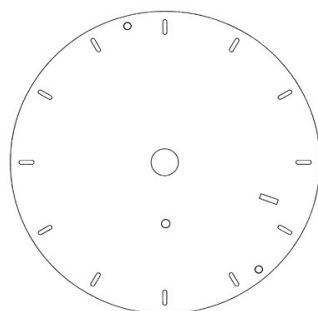

DM/068824-2

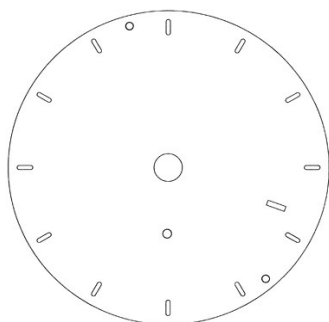
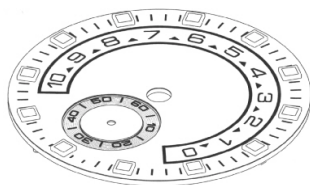

(11) Rahvusvah reg nr	DM/068951	(51) Klass: 09-03
(21) Rahvusvah reg jrk	H200700032	
(15) Registreeringu päev	26.04.2007	
(28) Variantide arv	1	
(72) Autor	MEHMET SEDAT YALINKAYA	
(73) Omanik	YALINKAYA HOLDING ANONIM SIRKETI, Keresteciler Sitesi Kayalar Sok No 24, MERTER/ISTANBUL, TR	
WIPO Rahvusvah Tööstusdisainilahenduste Bülletääni nr, kus registreering on avaldatud	2007/05	

(55) **Reproduksioon**

DM/068951-1



(11) Rahvusvah reg nr

DM/069082

(51) Klass: 11-01

(21) Rahvusvah reg jrk

H200700045

(15) Registreeringu päev

28.06.2007

(28) Variantide arv

1

(72) Autor

Arlette Elsa EMCH DUCOMMUN

(73) Omanik

MONTRES BREGUET S.A., CH-1344 L'ABBAYE, CH

WIPO Rahvusvah Tööstusdisainilahenduste

Bülletääni nr, kus registreering on avaldatud 2007/07

(55) Reproduksioon

DM/069082-1



(11) Rahvusvah reg nr	DM/069082	(51) Klass: 11-01
(21) Rahvusvah reg jrk	H200700045A	
(15) Registreeringu päev	28.06.2007	
(28) Variantide arv	1	
(23) Prioriteediandmed	12.04.2007, BASELWORLD 2007, BASEL, CH	
(72) Autor	Arlette Elsa EMCH DUCOMMUN	
(73) Omanik	MONTRES BREGUET S.A., CH-1344 L'ABBAYE, CH	
WIPO Rahvusvah Tööstusdisainilahenduste		
Bülletääni nr, kus registreering on avaldatud	2007/07	

(55) **Reproduksioon**

DM/069082-1



(11) **Rahvusvah reg nr**

DM/069082

(51) Klass: **11-01**

(21) **Rahvusvah reg jrk**

H200700045B

(15) **Registreeringu päev**

28.06.2007

(28) **Variantide arv**

1

(72) **Autor**

Arlette Elsa EMCH DUCOMMUN

(73) **Omanik**

MONTRES BREGUET S.A., CH-1344 L'ABBAYE, CH

WIPO Rahvusvah Tööstusdisainilahenduste

Bülletääni nr, kus registreering on avaldatud 2007/07

(55) **Reproduksioon**

DM/069082-1



(11) Rahvusvah reg nr	DM/069082	(51) Klass: 11-01
(21) Rahvusvah reg jrk	H200700045C	
(15) Registreeringu päev	28.06.2007	
(28) Variantide arv	1	
(23) Prioriteediandmed	12.04.2007, BASELWORLD 2007, BASEL, CH	
(72) Autor	Arlette Elsa EMCH DUCOMMUN	
(73) Omanik	MONTRES BREGUET S.A., CH-1344 L'ABBAYE, CH	
WIPO Rahvusvah Tööstusdisainilahenduste		
Bülletääni nr, kus registreering on avaldatud	2007/07	

(55) **Reproduksioon**

DM/069082-1



(11) Rahvusvah reg nr	DM/069082	(51) Klass: 11-01
(21) Rahvusvah reg jrk	H200700045D	
(15) Registreeringu päev	28.06.2007	
(28) Variantide arv	1	
(72) Autor	Arlette Elsa EMCH DUCOMMUN	
(73) Omanik	MONTRES BREGUET S.A., CH-1344 L'ABBAYE, CH	
WIPO Rahvusvah Tööstusdisainilahenduste		
Bülletääni nr, kus registreering on avaldatud	2007/07	

(55) **Reproduksioon**

DM/069082-1



- (11) **Rahvusvah reg nr** **DM/069082** (51) Klass: **11-01**
- (21) **Rahvusvah reg jrk** H200700045E
- (15) **Registreeringu päev** 28.06.2007
- (28) **Variantide arv** 1
- (72) **Autor** Arlette Elsa EMCH DUCOMMUN
- (73) **Omanik** MONTRES BREGUET S.A., CH-1344 L'ABBAYE, CH
- WIPO Rahvusvah Tööstusdisainilahenduste**
Bülletääni nr, kus registreering on avaldatud 2007/07

(55) **Reproduksioon**

DM/069082-1



- (11) **Rahvusvah reg nr** **DM/069082** (51) Klass: **11-01**
- (21) **Rahvusvah reg jrk** H200700045F
- (15) **Registreeringu päev** 28.06.2007
- (28) **Variantide arv** 1
- (23) **Prioriteediandmed** 12.04.2007, BASELWORLD 2007, BASEL, CH
- (72) **Autor** Arlette Elsa EMCH DUCOMMUN
- (73) **Omanik** MONTRES BREGUET S.A., CH-1344 L'ABBAYE, CH
- WIPO Rahvusvah Tööstusdisainilahenduste**
Bülletääni nr, kus registreering on avaldatud 2007/07

(55) **Reproduksioon**

DM/069082-1



- (11) **Rahvusvah reg nr** DM/069082 (51) Klass: **11-01**
- (21) **Rahvusvah reg jrk** H200700045G
- (15) **Registreeringu päev** 28.06.2007
- (28) **Komplektide arv** 1
- (23) **Prioriteediandmed** 12.04.2007, BASELWORLD 2007, BASEL, CH
- (72) **Autor** Arlette Elsa EMCH DUCOMMUN
- (73) **Omanik** MONTRES BREGUET S.A., CH-1344 L'ABBAYE, CH
- WIPO Rahvusvah Tööstusdisainilahenduste**
Bülletääni nr, kus registreering on avaldatud 2007/07

(55) **Reproduktsoon**

DM/069082-1



(11) Rahvusvah reg nr	DM/069083	(51) Klass: 11-01
(21) Rahvusvah reg jrk	H200700046	
(15) Registreeringu päev	28.06.2007	
(28) Variantide arv	1	
(72) Autor	Arlette Elsa EMCH DUCOMMUN	
(73) Omanik	THE SWATCH GROUP MANAGEMENT SERVICES AG (THE SWATCH GROUP MANAGEMENT SERVICES SA), (THE SWATCH GROUP MANAGEMENT SERVICES LTD), Seevorstadt 6, CH-2502 Biel/Bienne, CH	

**WIPO Rahvusvah Tööstusdisainilahenduste
Bülletääni nr, kus registreering on avaldatud** 2007/07

(55) **Reproduksioon**

DM/069083-1



(11) Rahvusvah reg nr	DM/069083	(51) Klass: 11-01
(21) Rahvusvah reg jrk	H200700046A	
(15) Registreeringu päev	28.06.2007	
(28) Variantide arv	1	
(72) Autor	Arlette Elsa EMCH DUCOMMUN	
(73) Omanik	THE SWATCH GROUP MANAGEMENT SERVICES AG (THE SWATCH GROUP MANAGEMENT SERVICES SA), (THE SWATCH GROUP MANAGEMENT SERVICES LTD), Seevorstadt 6, CH-2502 Biel/Bienne, CH	

**WIPO Rahvusvah Tööstusdisainilahenduste
Bülletääni nr, kus registreering on avaldatud** 2007/07

(55) **Reproduksioon**

DM/069083-1



(11) Rahvusvah reg nr	DM/069083	(51) Klass: 11-01
(21) Rahvusvah reg jrk	H200700046B	
(15) Registreeringu päev	28.06.2007	
(28) Variantide arv	1	
(72) Autor	Arlette Elsa EMCH DUCOMMUN	
(73) Omanik	THE SWATCH GROUP MANAGEMENT SERVICES AG (THE SWATCH GROUP MANAGEMENT SERVICES SA), (THE SWATCH GROUP MANAGEMENT SERVICES LTD), Seevorstadt 6, CH-2502 Biel/Bienne, CH	

WIPO Rahvusvah Tööstusdisainilahenduste
Bülletääni nr, kus registreering on avaldatud 2007/07

(55) **Reproduksioon**

DM/069083-1



(11) Rahvusvah reg nr	DM/069083	(51) Klass: 11-01
(21) Rahvusvah reg jrk	H200700046C	
(15) Registreeringu päev	28.06.2007	
(28) Variantide arv	1	
(72) Autor	Arlette Elsa EMCH DUCOMMUN	
(73) Omanik	THE SWATCH GROUP MANAGEMENT SERVICES AG (THE SWATCH GROUP MANAGEMENT SERVICES SA), (THE SWATCH GROUP MANAGEMENT SERVICES LTD), Seevorstadt 6, CH-2502 Biel/Bienne, CH	

WIPO Rahvusvah Tööstusdisainilahenduste
Bülletääni nr, kus registreering on avaldatud 2007/07

(55) **Reproduksioon**

DM/069083-1



(11) Rahvusvah reg nr	DM/069083	(51) Klass: 11-01
(21) Rahvusvah reg jrk	H200700046D	
(15) Registreeringu päev	28.06.2007	
(28) Variantide arv	1	
(72) Autor	Arlette Elsa EMCH DUCOMMUN	
(73) Omanik	THE SWATCH GROUP MANAGEMENT SERVICES AG (THE SWATCH GROUP MANAGEMENT SERVICES SA), (THE SWATCH GROUP MANAGEMENT SERVICES LTD), Seevorstadt 6, CH-2502 Biel/Bienne, CH	

**WIPO Rahvusvah Tööstusdisainilahenduste
Bülletääni nr, kus registreering on avaldatud** 2007/07

(55) **Reproduksioon**

DM/069083-1



(11) Rahvusvah reg nr	DM/069083	(51) Klass: 11-01
(21) Rahvusvah reg jrk	H200700046E	
(15) Registreeringu päev	28.06.2007	
(28) Variantide arv	1	
(72) Autor	Arlette Elsa EMCH DUCOMMUN	
(73) Omanik	THE SWATCH GROUP MANAGEMENT SERVICES AG (THE SWATCH GROUP MANAGEMENT SERVICES SA), (THE SWATCH GROUP MANAGEMENT SERVICES LTD), Seevorstadt 6, CH-2502 Biel/Bienne, CH	

**WIPO Rahvusvah Tööstusdisainilahenduste
Bülletääni nr, kus registreering on avaldatud** 2007/07

(55) **Reproduksioon**

DM/069083-1



(11) Rahvusvah reg nr	DM/069083	(51) Klass: 11-01
(21) Rahvusvah reg jrk	H200700046F	
(15) Registreeringu päev	28.06.2007	
(28) Variantide arv	3	
(72) Autor	Arlette Elsa EMCH DUCOMMUN	
(73) Omanik	THE SWATCH GROUP MANAGEMENT SERVICES AG (THE SWATCH GROUP MANAGEMENT SERVICES SA), (THE SWATCH GROUP MANAGEMENT SERVICES LTD), Seevorstadt 6, CH-2502 Biel/Bienne, CH	

WIPO Rahvusvah Tööstusdisainilahenduste
Bülletääni nr, kus registreering on avaldatud 2007/07

(55) **Reproduksioon**

DM/069083-1



DM/069083-2



DM/069083-3



(11) Rahvusvah reg nr	DM/069084	(51) Klass: 10-02
(21) Rahvusvah reg jrk	H200700047	
(15) Registreeringu päev	28.06.2007	
(28) Variantide arv	1	
(72) Autor	Adelina BISSOLO	
(73) Omanik	SWATCH AG (SWATCH SA) (SWATCH LTD.), Jakob-Stämpfli-Strasse 94, CH-2502 Biel/Bienne, CH	

WIPO Rahvusvah Tööstusdisainilahenduste
Bülletääni nr, kus registreering on avaldatud 2007/07

(55) **Reproduksioon**

DM/069084-1



(11) Rahvusvah reg nr	DM/069096	(51) Klass: 11-01
(21) Rahvusvah reg jrk	H200700048	
(15) Registreeringu päev	28.06.2007	
(28) Variantide arv	2	
(72) Autor	Arlette Elsa EMCH DUCOMMUN	
(73) Omanik	THE SWATCH GROUP MANAGEMENT SERVICES AG (THE SWATCH GROUP MANAGEMENT SERVICES SA), (THE SWATCH GROUP MANAGEMENT SERVICES LTD), Seevorstadt 6, CH-2502 Biel/Bienne, CH	

**WIPO Rahvusvah Tööstusdisainilahenduste
Bülletääni nr, kus registreering on avaldatud** 2007/07

(55) **Reproduksioon**

DM/069096-1

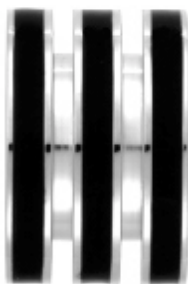

DM/069096-2



(11) Rahvusvah reg nr	DM/069096	(51) Klass: 11-01
(21) Rahvusvah reg jrk	H200700048A	
(15) Registreeringu päev	28.06.2007	
(28) Variantide arv	1	
(72) Autor	Arlette Elsa EMCH DUCOMMUN	
(73) Omanik	THE SWATCH GROUP MANAGEMENT SERVICES AG (THE SWATCH GROUP MANAGEMENT SERVICES SA), (THE SWATCH GROUP MANAGEMENT SERVICES LTD), Seevorstadt 6, CH-2502 Biel/Bienne, CH	

**WIPO Rahvusvah Tööstusdisainilahenduste
Bülletääni nr, kus registreering on avaldatud** 2007/07

(55) **Reproduksioon**

DM/069096-1



(11) Rahvusvah reg nr	DM/069096	(51) Klass: 11-01
(21) Rahvusvah reg jrk	H200700048B	
(15) Registreeringu päev	28.06.2007	
(28) Variantide arv	3	
(72) Autor	Arlette Elsa EMCH DUCOMMUN	
(73) Omanik	THE SWATCH GROUP MANAGEMENT SERVICES AG (THE SWATCH GROUP MANAGEMENT SERVICES SA), (THE SWATCH GROUP MANAGEMENT SERVICES LTD), Seevorstadt 6, CH-2502 Biel/Bienne, CH	

**WIPO Rahvusvah Tööstusdisainilahenduste
Bülletääni nr, kus registreering on avaldatud** 2007/07

(55) **Reproduksioon**

DM/069096-1



DM/069096-2



DM/069096-3



(11) **Rahvusvah reg nr**

DM/069096

(51) Klass: **11-01**

(21) **Rahvusvah reg jrk**

H200700048C

(15) **Registreeringu päev**

28.06.2007

(28) **Variantide arv**

3

(72) **Autor**

Arlette Elsa EMCH DUCOMMUN

(73) **Omanik**

THE SWATCH GROUP MANAGEMENT SERVICES AG
(THE SWATCH GROUP MANAGEMENT SERVICES SA),
(THE SWATCH GROUP MANAGEMENT SERVICES LTD),
Seevorstadt 6, CH-2502 Biel/Bienne, CH

WIPO Rahvusvah Tööstusdisainilahenduste

Bülletääni nr, kus registreering on avaldatud 2007/07

(55) **Reproduktsoon**

DM/069096-1



DM/069096-2



DM/069096-3



(11) Rahvusvah reg nr	DM/069096	(51) Klass: 11-01
(21) Rahvusvah reg jrk	H200700048D	
(15) Registreeringu päev	28.06.2007	
(28) Variantide arv	1	
(72) Autor	Arlette Elsa EMCH DUCOMMUN	
(73) Omanik	THE SWATCH GROUP MANAGEMENT SERVICES AG (THE SWATCH GROUP MANAGEMENT SERVICES SA), (THE SWATCH GROUP MANAGEMENT SERVICES LTD), Seevorstadt 6, CH-2502 Biel/Bienne, CH	

WIPO Rahvusvah Tööstusdisainilahenduste
Bülletääni nr, kus registreering on avaldatud 2007/07

(55) **Reproduksioon**

DM/069096-1



(11) **Rahvusvah reg nr**

DM/069101

(51) Klass: **10-02**

(21) **Rahvusvah reg jrk**

H200700049

(15) **Registreeringu päev**

12.07.2007

(28) **Variantide arv**

1

(72) **Autor**

Andrea ARRIGONI

(73) **Omanik**

SWATCH AG (SWATCH SA) (SWATCH LTD.),
Jakob-Stämpfli-Strasse 94, CH-2502 Biel/Bienne, CH

WIPO Rahvusvah Tööstusdisainilahenduste

Bülletääni nr, kus registreering on avaldatud 2007/07

(55) **Reproduksioon**

DM/069101-1



(11) Rahvusvah reg nr	DM/069173	(51) Klass: 11-01
(21) Rahvusvah reg jrk	H200700055	
(15) Registreeringu päev	16.08.2007	
(28) Variantide arv	1	
(72) Autor	Arlette Elsa EMCH DUCOMMUN	
(73) Omanik	THE SWATCH GROUP MANAGEMENT SERVICES AG (THE SWATCH GROUP MANAGEMENT SERVICES SA), (THE SWATCH GROUP MANAGEMENT SERVICES LTD.), Seevorstadt 6, CH-2502 BIENNE, CH	

**WIPO Rahvusvah Tööstusdisainilahenduste
Bülletääni nr, kus registreering on avaldatud** 2007/08

(55) **Reproduksioon**

DM/069173-1



(11) Rahvusvah reg nr	DM/069173	(51) Klass: 11-01
(21) Rahvusvah reg jrk	H200700055A	
(15) Registreeringu päev	16.08.2007	
(28) Variantide arv	1	
(72) Autor	Arlette Elsa EMCH DUCOMMUN	
(73) Omanik	THE SWATCH GROUP MANAGEMENT SERVICES AG (THE SWATCH GROUP MANAGEMENT SERVICES SA), (THE SWATCH GROUP MANAGEMENT SERVICES LTD.), Seevorstadt 6, CH-2502 BIENNE, CH	

**WIPO Rahvusvah Tööstusdisainilahenduste
Bülletääni nr, kus registreering on avaldatud** 2007/08

(55) **Reproduksioon**

DM/069173-1



(11) Rahvusvah reg nr	DM/069173	(51) Klass: 11-01
(21) Rahvusvah reg jrk	H200700055B	
(15) Registreeringu päev	16.08.2007	
(28) Variantide arv	2	
(72) Autor	Arlette Elsa EMCH DUCOMMUN	
(73) Omanik	THE SWATCH GROUP MANAGEMENT SERVICES AG (THE SWATCH GROUP MANAGEMENT SERVICES SA), (THE SWATCH GROUP MANAGEMENT SERVICES LTD.), Seevorstadt 6, CH-2502 BIENNE, CH	

**WIPO Rahvusvah Tööstusdisainilahenduste
Bülletääni nr, kus registreering on avaldatud** 2007/08

(55) **Reproduksioon**

DM/069173-1



DM/069173-2



(11) Rahvusvah reg nr	DM/069173	(51) Klass: 11-01
(21) Rahvusvah reg jrk	H200700055C	
(15) Registreeringu päev	16.08.2007	
(28) Variantide arv	1	
(72) Autor	Arlette Elsa EMCH DUCOMMUN	
(73) Omanik	THE SWATCH GROUP MANAGEMENT SERVICES AG (THE SWATCH GROUP MANAGEMENT SERVICES SA), (THE SWATCH GROUP MANAGEMENT SERVICES LTD.), Seevorstadt 6, CH-2502 BIENNE, CH	

**WIPO Rahvusvah Tööstusdisainilahenduste
Bülletääni nr, kus registreering on avaldatud** 2007/08

(55) **Reproduksioon**

DM/069173-1



(11) Rahvusvah reg nr	DM/069173	(51) Klass: 11-01
(21) Rahvusvah reg jrk	H200700055D	
(15) Registreeringu päev	16.08.2007	
(28) Variantide arv	1	
(72) Autor	Arlette Elsa EMCH DUCOMMUN	
(73) Omanik	THE SWATCH GROUP MANAGEMENT SERVICES AG (THE SWATCH GROUP MANAGEMENT SERVICES SA), (THE SWATCH GROUP MANAGEMENT SERVICES LTD.), Seevorstadt 6, CH-2502 BIENNE, CH	

**WIPO Rahvusvah Tööstusdisainilahenduste
Bülletääni nr, kus registreering on avaldatud** 2007/08

(55) **Reproduksioon**

DM/069173-1



(11) Rahvusvah reg nr	DM/069174	(51) Klass: 11-01
(21) Rahvusvah reg jrk	H200700054	
(15) Registreeringu päev	16.08.2007	
(28) Variantide arv	1	
(72) Autor	Arlette Elsa EMCH DUCOMMUN	
(73) Omanik	THE SWATCH GROUP MANAGEMENT SERVICES AG (THE SWATCH GROUP MANAGEMENT SERVICES SA), (THE SWATCH GROUP MANAGEMENT SERVICES LTD.), Seevorstadt 6, CH-2502 BIENNE, CH	

**WIPO Rahvusvah Tööstusdisainilahenduste
Bülletääni nr, kus registreering on avaldatud** 2007/08

(55) **Reproduksioon**

DM/069174-1



(11) Rahvusvah reg nr	DM/069174	(51) Klass: 11-01
(21) Rahvusvah reg jrk	H200700054A	
(15) Registreeringu päev	16.08.2007	
(28) Variantide arv	1	
(72) Autor	Arlette Elsa EMCH DUCOMMUN	
(73) Omanik	THE SWATCH GROUP MANAGEMENT SERVICES AG (THE SWATCH GROUP MANAGEMENT SERVICES SA), (THE SWATCH GROUP MANAGEMENT SERVICES LTD.), Seevorstadt 6, CH-2502 BIENNE, CH	

**WIPO Rahvusvah Tööstusdisainilahenduste
Bülletääni nr, kus registreering on avaldatud** 2007/08

(55) **Reproduksioon**

DM/069174-1



(11) Rahvusvah reg nr	DM/069219	(51) Klass: 10-07
(21) Rahvusvah reg jrk	H200700053	
(15) Registreeringu päev	16.08.2007	
(28) Variantide arv	1	
(72) Autor	Walter GARRO	
(73) Omanik	SWATCH AG (SWATCH SA) (SWATCH LTD.), Jakob-Stämpfli-Strasse 94, CH-2502 Biel/Bienne, CH	
WIPO Rahvusvah Tööstusdisainilahenduste Bülletääni nr, kus registreering on avaldatud	2007/08	

(55) **Reproduksioon**

DM/069219-1

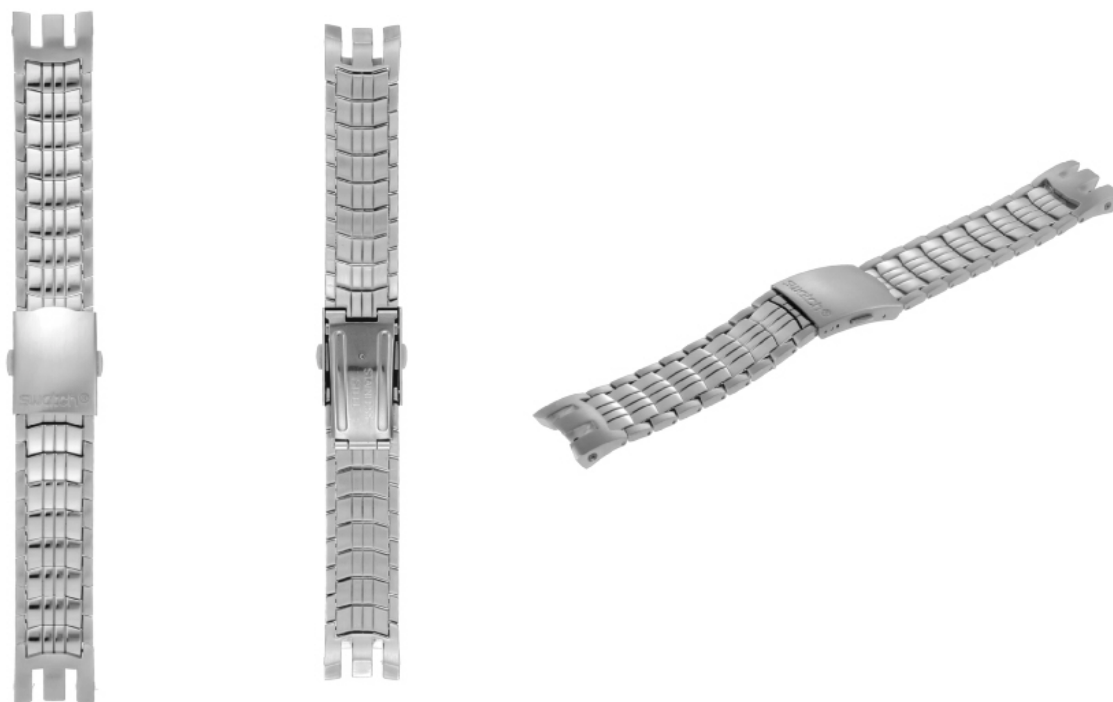

(11) **Rahvusvah reg nr**

DM/069225

(51) Klass: **10-07**

(21) **Rahvusvah reg jrk**

H200700052

(15) **Registreeringu päev**

24.08.2007

(28) **Variantide arv**

1

(72) **Autor**

Alessandra FORNARI

(73) **Omanik**

SWATCH AG (SWATCH SA) (SWATCH LTD.),
Jakob-Stämpfli-Strasse 94, CH-2502 Biel/Bienne, CH

**WIPO Rahvusvah Tööstusdisainilahenduste
Bülletääni nr, kus registreering on avaldatud**

2007/08

(55) **Reproduksioon**

DM/069225-1



(11) Rahvusvah reg nr	DM/069226	(51) Klass: 11-01
(21) Rahvusvah reg jrk	H200700051	
(15) Registreeringu päev	24.08.2007	
(28) Variantide arv	1	
(72) Autor	Arlette Elsa EMCH DUCOMMUN	
(73) Omanik	THE SWATCH GROUP MANAGEMENT SERVICES AG (THE SWATCH GROUP MANAGEMENT SERVICES SA), (THE SWATCH GROUP MANAGEMENT SERVICES LTD.), Seevorstadt 6, CH-2502 BIENNE, CH	

**WIPO Rahvusvah Tööstusdisainilahenduste
Bülletääni nr, kus registreering on avaldatud** 2007/08

(55) **Reproduksioon**

DM/069226-1



(11) Rahvusvah reg nr	DM/069226	(51) Klass: 11-01
(21) Rahvusvah reg jrk	H200700051A	
(15) Registreeringu päev	24.08.2007	
(28) Variantide arv	1	
(72) Autor	Arlette Elsa EMCH DUCOMMUN	
(73) Omanik	THE SWATCH GROUP MANAGEMENT SERVICES AG (THE SWATCH GROUP MANAGEMENT SERVICES SA), (THE SWATCH GROUP MANAGEMENT SERVICES LTD.), Seevorstadt 6, CH-2502 BIENNE, CH	

**WIPO Rahvusvah Tööstusdisainilahenduste
Bülletääni nr, kus registreering on avaldatud** 2007/08

(55) **Reproduksioon**

DM/069226-1



(11) Rahvusvah reg nr	DM/069233	(51) Klass: 10-02
(21) Rahvusvah reg jrk	H200700050	
(15) Registreeringu päev	27.08.2007	
(28) Variantide arv	1	
(72) Autor	Marco DRAGOTTA	
(73) Omanik	SWATCH AG (SWATCH SA) (SWATCH LTD.), Jakob-Stämpfli-Strasse 94, CH-2502 Biel/Bienne, CH	

**WIPO Rahvusvah Tööstusdisainilahenduste
Bülletääni nr, kus registreering on avaldatud** 2007/08

(55) **Reproduksioon**

DM/069233-1



(11) Rahvusvah reg nr	DM/069264	(51) Klass: 10-07
(21) Rahvusvah reg jrk	H200700061	
(15) Registreeringu päev	07.09.2007	
(28) Variantide arv	1	
(72) Autor	Rossana BOFFI	
(73) Omanik	SWATCH AG (SWATCH SA) (SWATCH LTD.), Jakob-Stämpfli-Strasse 94, CH-2502 Biel/Bienne, CH	

**WIPO Rahvusvah Tööstusdisainilahenduste
Bülletääni nr, kus registreering on avaldatud** 2007/09

(55) **Reproduksioon**

DM/069264-1



(11) **Rahvusvah reg nr**

DM/069310

(51) Klass: **10-07**

(21) **Rahvusvah reg jrk**

H200700062

(15) **Registreeringu päev**

18.09.2007

(28) **Variantide arv**

1

(72) **Autor**

Andrea ARRIGONI

(73) **Omanik**

SWATCH AG (SWATCH SA) (SWATCH LTD.),
Jakob-Stämpfli-Strasse 94, CH-2502 Biel/Bienne, CH

WIPO Rahvusvah Tööstusdisainilahenduste

Bülletääni nr, kus registreering on avaldatud 2007/9

(55) **Reproduksioon**

DM/069310-1



III. MUUD REGISTRIKANDED

REGISTREERINGU KEHTIVUSE PIKENDAMINE

Reg nr	Registreeringu pikendatud kehtivusaja lõppemise päev	
00228	09.04.2013	00253 25.05.2013
00230	09.04.2013	00315 26.05.2013
00232	22.04.2013	00316 26.05.2013
00233	22.04.2013	00317 26.05.2013
00234	23.04.2013	00318 26.05.2013
00235	24.04.2013	00778 14.01.2013
00236	24.04.2013	00782 06.03.2013
00237	24.04.2013	00783 06.03.2013
00238	24.04.2013	00784 06.03.2013
00239	24.04.2013	00785 06.03.2013
00240	24.04.2013	00787 13.03.2013
00241	24.04.2013	00788 13.03.2013
00242	28.04.2013	00789 13.03.2013
00243	28.04.2013	00790 13.03.2013
00247	06.05.2013	00792 26.02.2013
00248	06.05.2013	00794 04.03.2013
00249	08.05.2013	00797 06.03.2013
00251	25.05.2013	00798 10.03.2013
		00802 06.03.2013
		00803 06.03.2013
		00804 06.03.2013
		00805 06.03.2013
		00806 06.03.2013
		00807 06.03.2013
		00808 25.03.2013
		00811 05.05.2013
		00812 05.05.2013
		00813 05.05.2013
		00815 30.04.2013
		00816 30.04.2013
		00817 30.04.2013
		00818 30.04.2013
		00819 09.05.2013
		00820 09.05.2013
		00821 09.05.2013
		00827 27.06.2013
		00830 30.04.2013
		00831 30.04.2013
		00832 30.04.2013
		00833 30.04.2013
		00834 30.04.2013
		00835 30.04.2013
		00836 30.04.2013
		00837 30.04.2013
		00838 30.04.2013
		00839 30.04.2013
		00840 30.04.2013
		00841 30.04.2013
		00842 30.04.2013
		00854 15.04.2013
		00858 06.08.2013
		00859 06.03.2013

TÖÖSTUSDISAINILAHENDUSE ÜLEMINEK

Reg nr	Uue omaniku andmed	Registrikande jõustumise päev
00604	CK Holding AB, Box 729, SE 169 27 Solna, SE	28.03.2008
00608	CK Holding AB, Box 729, SE 169 27 Solna, SE	28.03.2008

REGISTREERINGU ANDMETE MUUDATUSED

Reg nr	Muutunud andmed	Registrikande jõustumise päev
00253	ARACARIA B.V., Spiegelgracht 15, 1017 JP Amsterdam, NL	18.04.2008
00474-00476	Jüri Käosaar, Patendibüroo Käosaar & Co OÜ, Tähe 94, 50107 Tartu, EE	22.04.2008
00480	Jüri Käosaar, Patendibüroo Käosaar & Co OÜ, Tähe 94, 50107 Tartu, EE	22.04.2008
00482, 00483	Jüri Käosaar, Patendibüroo Käosaar & Co OÜ, Tähe 94, 50107 Tartu, EE	22.04.2008
00486	Jüri Käosaar, Patendibüroo Käosaar & Co OÜ, Tähe 94, 50107 Tartu, EE	22.04.2008
00498	Jüri Käosaar, Patendibüroo Käosaar & Co OÜ, Tähe 94, 50107 Tartu, EE	22.04.2008
00505	Jüri Käosaar, Patendibüroo Käosaar & Co OÜ, Tähe 94, 50107 Tartu, EE	22.04.2008
00507	Jüri Käosaar, Patendibüroo Käosaar & Co OÜ, Tähe 94, 50107 Tartu, EE	22.04.2008
00512, 00513	Jüri Käosaar, Patendibüroo Käosaar & Co OÜ, Tähe 94, 50107 Tartu, EE	22.04.2008
00521-00524	Jüri Käosaar, Patendibüroo Käosaar & Co OÜ, Tähe 94, 50107 Tartu, EE	22.04.2008

Reg nr	Muutunud andmed	Registrikande jõustumise päev
00526-00528	Jüri Käosaar, Patendibüroo Käosaar & Co OÜ, Tähe 94, 50107 Tartu, EE	22.04.2008
00530-00542	Jüri Käosaar, Patendibüroo Käosaar & Co OÜ, Tähe 94, 50107 Tartu, EE	22.04.2008
00546-00548	Jüri Käosaar, Patendibüroo Käosaar & Co OÜ, Tähe 94, 50107 Tartu, EE	22.04.2008
00553, 00554	Jüri Käosaar, Patendibüroo Käosaar & Co OÜ, Tähe 94, 50107 Tartu, EE	22.04.2008
00560, 00561	Jüri Käosaar, Patendibüroo Käosaar & Co OÜ, Tähe 94, 50107 Tartu, EE	22.04.2008
00568-00576	Jüri Käosaar, Patendibüroo Käosaar & Co OÜ, Tähe 94, 50107 Tartu, EE	22.04.2008
00582, 00583	Jüri Käosaar, Patendibüroo Käosaar & Co OÜ, Tähe 94, 50107 Tartu, EE	22.04.2008
00585	Jüri Käosaar, Patendibüroo Käosaar & Co OÜ, Tähe 94, 50107 Tartu, EE	22.04.2008
00604	Jüri Käosaar, Patendibüroo Käosaar & Co OÜ, Tähe 94, 50107 Tartu, EE	28.03.2008
00608	Jüri Käosaar, Patendibüroo Käosaar & Co OÜ, Tähe 94, 50107 Tartu, EE	28.03.2008
00615	Jüri Käosaar, Patendibüroo Käosaar & Co OÜ, Tähe 94, 50107 Tartu, EE	22.04.2008
00617	Jüri Käosaar, Patendibüroo Käosaar & Co OÜ, Tähe 94, 50107 Tartu, EE	22.04.2008
00716	Jüri Käosaar, Patendibüroo Käosaar & Co OÜ, Tähe 94, 50107 Tartu, EE	22.04.2008
00740-00743	Jüri Käosaar, Patendibüroo Käosaar & Co OÜ, Tähe 94, 50107 Tartu, EE	22.04.2008
00747	Jüri Käosaar, Patendibüroo Käosaar & Co OÜ, Tähe 94, 50107 Tartu, EE	22.04.2008
00769	Jüri Käosaar, Patendibüroo Käosaar & Co OÜ, Tähe 94, 50107 Tartu, EE	22.04.2008
00778	Jüri Käosaar, Patendibüroo Käosaar & Co OÜ, Tähe 94, 50107 Tartu, EE	22.04.2008
00792	Jüri Käosaar, Patendibüroo Käosaar & Co OÜ, Tähe 94, 50107 Tartu, EE	22.04.2008
00825, 00826	Jüri Käosaar, Patendibüroo Käosaar & Co OÜ, Tähe 94, 50107 Tartu, EE	22.04.2008
00830-00842	Jüri Käosaar, Patendibüroo Käosaar & Co OÜ, Tähe 94, 50107 Tartu, EE	22.04.2008
00845	Jüri Käosaar, Patendibüroo Käosaar & Co OÜ, Tähe 94, 50107 Tartu, EE	22.04.2008
00847	Jüri Käosaar, Patendibüroo Käosaar & Co OÜ, Tähe 94, 50107 Tartu, EE	22.04.2008
00875	Jüri Käosaar, Patendibüroo Käosaar & Co OÜ, Tähe 94, 50107 Tartu, EE	22.04.2008
00881, 00882	Jüri Käosaar, Patendibüroo Käosaar & Co OÜ, Tähe 94, 50107 Tartu, EE	22.04.2008
00884	Jüri Käosaar, Patendibüroo Käosaar & Co OÜ, Tähe 94, 50107 Tartu, EE	22.04.2008
00900-00901	Jüri Käosaar, Patendibüroo Käosaar & Co OÜ, Tähe 94, 50107 Tartu, EE	22.04.2008
00924	Jüri Käosaar, Patendibüroo Käosaar & Co OÜ, Tähe 94, 50107 Tartu, EE	22.04.2008
00929, 00930	Jüri Käosaar, Patendibüroo Käosaar & Co OÜ, Tähe 94, 50107 Tartu, EE	22.04.2008
00936	Jüri Käosaar, Patendibüroo Käosaar & Co OÜ, Tähe 94, 50107 Tartu, EE	22.04.2008
01216	Jüri Käosaar, Patendibüroo Käosaar & Co OÜ, Tähe 94, 50107 Tartu, EE	22.04.2008

REGISTREERINGU ANDMETE PARANDUSED

Reg nr	Parandatavad andmed	Parandatud andmed	Registrikande jõustumise päev
01365	Charlie Bolton, 2 Oxford Terrace; Iain POTTIE, Guildford, Surrey GU1 3RJ, GB Anton Fahlgren, Nordre Frihavnsgrde 28, 2100 Copenhagen, DK Iain Pottie, Springbank, High Street, Little Sandhurst, Berkshire GU47 8LR, GB Sean Prior, 125 Gloucester Court, Kew Road, Richmond, Surrey TW9 3DY, GB	Charlie Bolton, 2 Oxford Terrace, Guildford, Surrey GU1 3RJ, GB Anton Fahlgren, Nordre Frihavnsgrde 28, 2100 Copenhagen, DK Iain Pottie, Springbank, High Street, Little Sandhurst, Berkshire GU47 8LR, GB Sean Prior, 125 Gloucester Court, Kew Road, Richmond, Surrey TW9 3DY, GB	15.02.2008

REGISTREERINGU KUSTUTAMINE

"Tööstusdisaini kaitse seaduse" paragrahvi 77 lõike 1 alusel on registrist kustutatud järgmised tööstusdisainilahendused:

Reg nr	Kustutamise kande jõustumise päev
--------	-----------------------------------

00682	26.07.2007
00683	26.07.2007
00687	16.08.2007
00688	16.08.2007
00689	16.08.2007
00690	16.08.2007
00692	04.09.2007
00693	04.09.2007
00706	09.08.2007
00707	04.09.2007
00708	04.09.2007
00709	18.09.2007
00710	20.09.2007
00715	18.10.2007
00720	21.08.2007
00721	21.08.2007
00726	20.09.2007
00732	21.08.2007
00733	21.08.2007
00749	07.10.2007

IV. LOENDID

REGISTREERITUD TÖÖSTUSDISAINILAHENDUSTE REGISTREERIMISE TAOTLUSTE
NUMBRILINE LOEND

Registreerimis- taotluse number	Registreeringu number
------------------------------------	--------------------------

D200700046	01386	D200700113	01403
D200700066	01387	D200700114	01404
D200700085	01388	D200700115	01405
D200700086	01389	D200700116	01406
D200700096	01390	D200700117	01407
D200700102	01391	D200800001	01408
D200700102A	01392	D200800003	01409
D200700103	01393	D200800004	01410
D200700104	01394	D200800005	01411
D200700105	01395	D200800007	01412
D200700106	01396	D200800008	01413
D200700107	01397	D200800009	01414
D200700108	01398	D200800010	01415
D200700109	01399	D200800011	01416
D200700110	01400	D200800012	01417
D200700111	01401	D200800022	01418
D200700112	01402		

RAHVUSVAHELISELT REGISTREERITUD TÖÖSTUSDISAINILAHENDUSTE
NUMBRILINE LOEND

Rahvusvah reg jrk	Rahvusvah reg nr
-------------------	------------------

H200700032	DM/068951	H200700049	DM/069101
H200700040	DM/068624	H200700050	DM/069233
H200700044	DM/068573	H200700051	DM/069226
H200700044A	DM/068573	H200700051A	DM/069226
H200700044B	DM/068573	H200700052	DM/069225
H200700045	DM/069082	H200700053	DM/069219
H200700045A	DM/069082	H200700054	DM/069174
H200700045B	DM/069082	H200700054A	DM/069174
H200700045C	DM/069082	H200700055	DM/069173
H200700045D	DM/069082	H200700055A	DM/069173
H200700045E	DM/069082	H200700055B	DM/069173
H200700045F	DM/069082	H200700055C	DM/069173
H200700045G	DM/069082	H200700055D	DM/069173
H200700046	DM/069083	H200700056	DM/068803
H200700046A	DM/069083	H200700056A	DM/068803
H200700046B	DM/069083	H200700057	DM/068748
H200700046C	DM/069083	H200700058	DM/068702
H200700046D	DM/069083	H200700059	DM/068823
H200700046E	DM/069083	H200700059A	DM/068823
H200700046F	DM/069083	H200700059B	DM/068823
H200700047	DM/069084	H200700060	DM/068824
H200700048	DM/069096	H200700060A	DM/068824
H200700048A	DM/069096	H200700060B	DM/068824
H200700048B	DM/069096	H200700061	DM/069264
H200700048C	DM/069096	H200700062	DM/069310
H200700048D	DM/069096		

V. TÖÖSTUSDISAINIALASED ÕIGUSAKTID JA MUU INFO

RIIKLIKUS PATENDIVOLINIKE REGISTRIS REGISTREERITUD PATENDIVOLINIKE NIMEKIRI
(seisuga 22. aprill 2008)

Register on asutatud 1. septembril 2001. a Vabariigi Valitsuse 7. augusti 2001. a määrusega nr 271 "Riikliku patendivolinike registri asutamine ja registri pidamise põhimäärus" (RT I 2001, 70, 426) patendivoliniku seaduse § 21 alusel (RT I 2001, 27, 151).

TEGEVUSVALDKOND: KAUBAMÄRK, TÖÖSTUSDISAINILAHENDUS JA GEOGRAAFILINE TÄHIS

Arno ANIJALG	OÜ USTERVALL Kivi 21-6 51009 Tartu pk 21, 51002 Tartu telefon: 744 1980 telefaks: 744 1785 e-post: anijalg@ustervall.ee http://www.ustervall.ee võõrkeeled: saksa, vene	Juhan HÄMMALOV	OÜ Intels Riia 11-3 51010 Tartu telefon: 742 0401 telefaks: 742 0326 e-post: intelses@estpak.ee võõrkeeled: inglise, saksa, vene
Aivo ARULA	Patendibüroo Käosaar & Co OÜ Tähe 94 50107 Tartu telefon: 738 3051 telefaks: 738 3055 e-post: info@kaosaar.ee http://www.kaosaar.ee võõrkeeled: inglise, vene	Uno JÄÄGER	Inseneribüroo Uneko OÜ Rüütli 51a, 80010 Pärnu telefon: 447 1021 telefaks: 447 1001 GSM: 515 1844 e-post: uno@estpak.ee võõrkeeled: inglise, soome, vene
Martina BÖCKLER-LORVI	OÜ LASVET Suurtüki 4a, 10133 Tallinn pk 3136, 10505 Tallinn telefon: 640 6600 telefaks: 640 6604 e-post: lasvet@lasvet.ee http://www.lasvet.ee võõrkeeled: inglise, soome	Sirje KAHU	OÜ USTERVALL Kivi 21-6 51009 Tartu pk 21, 51002 Tartu telefon: 744 1980 telefaks: 744 1785 e-post: skahu@ustervall.ee http://www.ustervall.ee võõrkeeled: inglise, vene
Indrek EELMETS	Advokaadibüroo Sorainen OÜ Pärnu mnt 15 10141 Tallinn telefon: 640 0900 telefaks: 640 0901 e-post: sorainen@sorainen.ee http://www.sorainen.com võõrkeeled: inglise, vene, soome	Lembit KALEV	Patendibüroo ROOSILLA OÜ Järveotsa tee 39-61 13520 Tallinn telefon: 657 1722, 657 5381 telefaks: 657 5381 GSM: 511 9951 e-post: roosilla@roosilla.ee http://www.roosilla.ee võõrkeeled: inglise, vene
Alla HÄMMALOV	OÜ Intels Riia 11-3 51010 Tartu telefon: 742 0401 telefaks: 742 0326 e-post: intelses@estpak.ee võõrkeeled: inglise, poola, vene	Anneli KANG	OÜ Synest pk 977, 13402 Tallinn telefon: 660 9786 telefaks: 660 9787 e-post: anneli@synest.ee võõrkeeled: inglise, saksa, vene, prantsuse, soome, rootsi

- Urmas KAULER** **Patendibüroo TURVAJA OÜ**
 Liivalaia 22
 10118 Tallinn
 telefon: 640 3109
 telefaks: 640 3105
 e-post: turvaja@turvaja.ee
 http://www.turvaja.ee
 võõrkeeled: inglise, vene, soome
- Urmas KERNU** **AAA Patendibüroo OÜ**
 Tartu mnt 16
 10117 Tallinn
 pk 3926, 10509 Tallinn
 telefon: 660 5910, 660 5911
 telefaks: 660 5912
 e-post: aaa@aaa.ee
 http://www.aaa.ee
 võõrkeeled: inglise, saksa, soome, vene
- Ljubov KESSELMAN** **OÜ Kesna**
 Tedre 77-52
 10616 Tallinn
 telefon: 660 8068
 telefaks: 660 8069
 e-post: kesna@kesna.ee
 http://www.kesna.ee
 võõrkeeled: inglise, vene
- Marina KESSELMAN** **OÜ Kesna**
 Tedre 77-52
 10616 Tallinn
 telefon: 660 8068
 telefaks: 660 8069
 e-post: kesna@kesna.ee
 http://www.kesna.ee
 võõrkeeled: inglise, saksa, vene
- Heinu KOITEL** **Patendi- & Kaubamärgibüroo Koitel OÜ**
 Tartu mnt 65
 10115 Tallinn
 pk 1759, 10902 Tallinn
 telefon: 603 3260
 telefaks: 603 3261
 e-post: koitel@koitel.ee
 http://www.koitel.ee
 võõrkeeled: inglise, soome, vene
- Raivo KOITEL** **Patendi- & Kaubamärgibüroo Koitel OÜ**
 Tartu mnt 65
 10115 Tallinn
 pk 1759, 10902 Tallinn
 telefon: 603 3260
 telefaks: 603 3261
 e-post: koitel@koitel.ee
 http://www.koitel.ee
 võõrkeeled: inglise, soome, vene
- Mart Enn KOPPEL** **Patendibüroo Koppel OÜ**
 Kajaka 4-10
 11317 Tallinn
 telefon: 677 4136
 telefaks: 677 4138
 e-post: info@koppelpb.com
 http://www.koppelpb.com
 võõrkeeled: inglise, vene, soome
- Heinrich KRUPP** **Patendibüroo TURVAJA OÜ**
 Liivalaia 22
 10118 Tallinn
 telefon: 640 3109
 telefaks: 640 3105
 e-post: turvaja@turvaja.ee
 http://www.turvaja.ee
 võõrkeeled: saksa, vene
- Jüri KÄOSAAR** **Patendibüroo Käosaar & Co OÜ**
 Tähe 94
 50107 Tartu
 telefon: 738 3051
 telefaks: 738 3055
 e-post: info@kaosaar.ee
 http://www.kaosaar.ee
 võõrkeeled: inglise, vene
- Kalev KÄOSAAR** **Patendibüroo Käosaar & Co OÜ**
 Peterburi tee 46
 11415 Tallinn
 telefon: 637 9484
 telefaks: 637 9485
 e-post: kalev.kaosaar@kaosaar.ee
 http://www.kaosaar.ee
 võõrkeeled: inglise, vene
- Reet MAASIKAMÄE** **OÜ Kaitsepurus**
 Mulla 4-3
 10611 Tallinn
 telefon: 673 9097, 633 2798
 telefaks: 677 4844
 e-post: purus@online.ee
 purus@hot.ee
 http://www.hot.ee/purus/
 võõrkeeled: inglise, vene
- Raivo MATSOO** **RM Hirvela Patendibüroo OÜ**
 Saku 15, 11314 Tallinn
 telefon: 614 0816
 telefaks: 614 0818
 e-post: hirvela@hirvela.ee
 võõrkeeled: inglise, vene

Elle MELLIK	AAA Patendibüroo OÜ Tartu mnt 16 10117 Tallinn pk 3926, 10509 Tallinn telefon: 660 5910, 660 5911 telefaks: 660 5912 e-post: aaa@aaa.ee http://www.aaa.ee võõrkeeled: inglise, vene	Jaak OSTRAT	OÜ LASVET Suurtüki 4a, 10133 Tallinn pk 3136, 10505 Tallinn telefon: 640 6600 telefaks: 640 6604 e-post: lasvet@lasvet.ee http://www.lasvet.ee võõrkeeled: inglise, saksa, soome, vene
Lembit MITT	AAA Patendibüroo OÜ Tartu mnt 16 10117 Tallinn pk 3926, 10509 Tallinn telefon: 660 5910, 660 5911 telefaks: 660 5912 e-post: aaa@aaa.ee http://www.aaa.ee võõrkeeled: inglise, vene	Villu PAVELTS	OÜ LASVET Suurtüki 4a, 10133 Tallinn pk 3136, 10505 Tallinn telefon: 640 6600 telefaks: 640 6604 e-post: lasvet@lasvet.ee http://www.lasvet.ee võõrkeeled: inglise, soome, vene
Ott MOORLAT	OÜ Moorlat & Ko Patendibüroo pk 723, 12902 Tallinn telefon: 655 0450, 654 2844 telefaks: 654 2844 e-post: ott.moorlat@moorlat.ee http://www.moorlat.ee võõrkeeled: inglise, vene	Toom PUNGAS	OÜ Synest pk 977, 13402 Tallinn telefon: 660 9786 telefaks: 660 9787 e-post: toom@synest.ee võõrkeeled: inglise, saksa, soome, vene
Anfia MORNA	Patendibüroo TURVAJA OÜ Liivalaia 22, 10118 Tallinn telefon: 640 3109 telefaks: 640 3105 e-post: turvaja@turvaja.ee http://www.turvaja.ee võõrkeeled: inglise, vene	Kaie PUUR	Advokaadibüroo Rando Antsmäe OÜ Raekoja plats 13 51004 Tartu telefon: 742 2770 telefaks: 742 2771 e-post: kaie.puur@antsmae.ee http://www.antsmae.ee võõrkeeled: inglise, vene
Tõnu NELAS	AAA Patendibüroo OÜ Tartu mnt 16 10117 Tallinn pk 3926, 10509 Tallinn telefon: 660 5910, 660 5911 telefaks: 660 5912 e-post: aaa@aaa.ee http://www.aaa.ee võõrkeeled: inglise, vene, soome	Riina PÄRN	OÜ Intels Riia 11-3 51010 Tartu telefon: 742 0401 telefaks: 742 0326 e-post: intelses@estpak.ee võõrkeeled: inglise, vene
Jüri OLT	Patendibüroo Käosaar & Co OÜ Tähe 94, 50107 Tartu telefon: 738 3051 telefaks: 738 3055 e-post: info@kaosaar.ee http://www.kaosaar.ee võõrkeeled: inglise, saksa, soome, vene	Tarmo ROSMAN	Rosman ja Partnerid OÜ pk 652, 12602 Tallinn telefon: 656 1450 telefaks: 656 1450 e-post: tarman@cc.ttu.ee võõrkeeled: saksa, inglise, ungari, vene
		Arvo SALUMÄE	OÜ Amende Patendibüroo Raua 65 10152 Tallinn telefon: 648 6125 telefaks: 641 0174 e-post: amende@hot.ee võõrkeeled: inglise, saksa, soome, vene

Almar SEHVER**AAA Patendibüroo OÜ**

Tartu mnt 16
10117 Tallinn
pk 3926, 10509 Tallinn
telefon: 660 5910, 660 5911
telefaks: 660 5912
e-post: aaa@aaa.ee
http://www.aaa.ee
võõrkeeled: inglise, vene

Olga TREUFELDT**Patendibüroo TURVAJA OÜ**

Liivalaia 22
10118 Tallinn
telefon: 640 3109
telefaks: 640 3105
e-post: turvaja@turvaja.ee
http://www.turvaja.ee
võõrkeeled: inglise, vene

Harald TEHVER**Patendibüroo TURVAJA OÜ**

Liivalaia 22
10118 Tallinn
telefon: 640 3109
telefaks: 640 3105
e-post: turvaja@turvaja.ee
http://www.turvaja.ee
võõrkeeled: inglise, saksa, vene

Enn URGAS**Patendibüroo TURVAJA OÜ**

Liivalaia 22
10118 Tallinn
telefon: 640 3109
telefaks: 640 3105
e-post: turvaja@turvaja.ee
http://www.turvaja.ee
võõrkeeled: inglise, vene

Mari TOOMSOO**OÜ Advokaadibüroo Raidla & Partnerid**

Roosikrantsi 2, 10119 Tallinn
telefon: 640 7170
telefaks: 640 7171
e-post: email@raidla.ee
http://www.raidla.ee
võõrkeeled: inglise, soome

Juta-Maris UUSTALU**OÜ Amende Patendibüroo**

Raua 65
10152 Tallinn
telefon: 648 6125
telefaks: 641 0174
e-post: amende@hot.ee
võõrkeeled: inglise, vene

**LIST OF PATENT ATTORNEYS, REGISTERED IN
THE ESTONIAN STATE REGISTER OF PATENT ATTORNEYS**
(by 22 April 2008)

Register is established on September 1st 2001

FIELD OF ACTIVITY: TRADEMARKS, INDUSTRIAL DESIGNS AND GEOGRAPHICAL INDICATIONS

Arno ANIJALG	USTERVALL Ltd. Kivi 21-6 51009 Tartu, Estonia P.O. Box 21 51002 Tartu, Estonia Phone: +372 744 1980 Fax: +372 744 1785 E-mail: anijalg@ustervall.ee Http://www.ustervall.ee German, Russian, Estonian	Juhan HÄMMALOV	Intels Ltd. Riia Str. 11-3 51010 Tartu, Estonia Phone: +372 742 0401 Fax: +372 742 0326 E-mail: intelses@estpak.ee English, German, Russian, Estonian
Aivo ARULA	Patent Agency Käosaar & Co Tähe Str. 94 50107 Tartu, Estonia Phone: +372 738 3051 Fax: +372 738 3055 E-mail: info@kaosaar.ee Http://www.kaosaar.ee English, Russian, Estonian	Uno JÄÄGER	Inseneribüroo Uneko Ltd. Rüütli 51a 80010 Pärnu, Estonia Phone: +372 447 1021 Fax: +372 447 1001 GSM: +372 515 1844 E-mail: uno@estpak.ee English, Finnish, Russian, Estonian
Martina BÖCKLER-LORVI	Lasvet Ltd. P.O. Box 3136 10505 Tallinn, Estonia Phone: +372 640 6600 Fax: +372 640 6604 E-mail: lasvet@lasvet.ee Http://www.lasvet.ee English, Finnish, Estonian	Sirje KAHU	USTERVALL Ltd. Kivi 21-6 51009 Tartu, Estonia P.O. Box 21 51002 Tartu, Estonia Phone: +372 744 1980 Fax: +372 744 1785 E-mail: skahu@ustervall.ee Http://www.ustervall.ee English, Russian, Estonian
Indrek EELMETS	Sorainen Law Office Pärnu Road 15 10141 Tallinn, Estonia Phone: +372 640 0900 Fax: +372 640 0901 E-mail: sorainen@sorainen.ee Http://www.sorainen.com English, Russian, Finnish, Estonian	Lembit KALEV	Patent Bureau ROOSILLA Ltd. Järveotsa Road 39-61 13520 Tallinn, Estonia Phone: +372 657 1722 +372 657 5381 Fax: +372 657 5381 GSM: +372 511 9951 E-mail: roosilla@roosilla.ee Http://www.roosilla.ee English, Russian, Estonian
Alla HÄMMALOV	Intels Ltd. Riia Str. 11-3 51010 Tartu, Estonia Phone: +372 742 0401 Fax: +372 742 0326 E-mail: intelses@estpak.ee English, Polish, Russian, Estonian	Anneli KANG	Synest Ltd. P.O. Box 977 13402 Tallinn, Estonia Phone: +372 660 9786 Fax: +372 660 9787 E-mail: anneli@synest.ee English, German, Russian, French, Finnish, Swedish, Estonian

Urmas KAULER	Patendibüroo TURVAJA OÜ Liivalaia 22 10118 Tallinn, Estonia Phone: +372 640 3109 Fax: +372 640 3105 E-mail: turvaja@turvaja.ee Http://www.turvaja.ee English, Russian, Finnish, Estonian	Raivo KOITEL	Patent & Trademark Agency Koitel Tartu Road 65 10115 Tallinn, Estonia P.O. Box 1759 10902 Tallinn, Estonia Phone: +372 603 3260 Fax: +372 603 3261 E-mail: koitel@koitel.ee Http://www.koitel.ee English, Finnish, Russian, Estonian
Urmas KERNU	AAA Legal Services Tartu Road 16 10117 Tallinn, Estonia P.O. Box 3926 10509 Tallinn, Estonia Phone: +372 660 5910 +372 660 5911 Fax: +372 660 5912 E-mail: aaa@aaa.ee Http://www.aaa.ee English, German, Finnish, Russian, Estonian	Mart Enn KOPPEL	Patent Bureau Koppel Kajaka 4-10 11317 Tallinn, Estonia Phone: +372 677 4136 Fax: +372 677 4138 E-mail: info@koppelpb.com Http://www.koppelpb.com English, Russian, Finnish, Estonian
Marina KESSELMAN	Kesna Ltd. Tedre Str. 77-52 10616 Tallinn, Estonia Phone: +372 660 8068 Fax: +372 660 8069 E-mail: kesna@kesna.ee Http://www.kesna.ee English, German, Russian, Estonian	Heinrich KRUPP	Patendibüroo TURVAJA OÜ Liivalaia 22 10118 Tallinn, Estonia Phone: +372 640 3109 Fax: +372 640 3105 E-mail: turvaja@turvaja.ee Http://www.turvaja.ee German, Russian, Estonian
Ljubov KESSELMAN	Kesna Ltd. Tedre Str. 77-52 10616 Tallinn, Estonia Phone: +372 660 8068 Fax: +372 660 8069 E-mail: kesna@kesna.ee Http://www.kesna.ee English, Russian, Estonian	Jüri KÄOSAAR	Patent Agency Käosaar & Co Tähe Str. 94 50107 Tartu, Estonia Phone: +372 738 3051 Fax: +372 738 3055 E-mail: info@kaosaar.ee Http://www.kaosaar.ee English, Russian, Estonian
Heinu KOITEL	Patent & Trademark Agency Koitel Tartu Road 65 10115 Tallinn, Estonia P.O. Box 1759 10902 Tallinn, Estonia Phone: +372 603 3260 Fax: +372 603 3261 E-mail: koitel@koitel.ee Http://www.koitel.ee English, Finnish, Russian, Estonian	Kalev KÄOSAAR	Patent Agency Käosaar & Co Peterburi Road 46 11415 Tallinn, Estonia Phone: +372 637 9484 Fax: +372 637 9485 E-mail: kalev.kaosaar@kaosaar.ee Http://www.kaosaar.ee English, Russian, Estonian

- Reet MAASIKAMÄE** **Patent Bureau Kaitsepurus Ltd.**
Mulla Str. 4-3
10611 Tallinn, Estonia
Phone: +372 673 9097
+372 633 2798
Fax: +372 677 4844
E-mail: purus@online.ee
purus@hot.ee
Http://www.hot.ee/purus/
English, Russian, Estonian
- Raivo MATSOO** **RM Hirvela Patent Bureau Ltd**
Saku 15, 11314 Tallinn, Estonia
Phone: +372 614 0816
Fax: +372 614 0818
E-mail: hirvela@hirvela.ee
English, Russian, Estonian
- Elle MELLIK** **AAA Legal Services**
Tartu Road 16
10117 Tallinn, Estonia
P.O. Box 3926
10509 Tallinn, Estonia
Phone: +372 660 5910
+372 660 5911
Fax: +372 660 5912
E-mail: aaa@aaa.ee
Http://www.aaa.ee
English, Russian, Estonian
- Lembit MITT** **AAA Legal Services**
Tartu Road 16
10117 Tallinn, Estonia
P.O. Box 3926
10509 Tallinn, Estonia
Phone: +372 660 5910
+372 660 5911
Fax: +372 660 5912
E-mail: aaa@aaa.ee
Http://www.aaa.ee
English, Russian, Estonian
- Ott MOORLAT** **Moorlat & Co Ltd. Patent Bureau**
P.O. Box 723
12902 Tallinn, Estonia
Phone: +372 655 0450
+372 654 2844
Fax: +372 654 2844
E-mail: ott.moorlat@moorlat.ee
Http://www.moorlat.ee
English, Russian, Estonian
- Anfia MORNA**
- Tõnu NELSAS**
- Patendibüroo TURVAJA OÜ**
Liivalaia 22
10118 Tallinn, Estonia
Phone: +372 640 3109
Fax: +372 640 3105
E-mail: turvaja@turvaja.ee
Http://www.turvaja.ee
English, Russian, Estonian
- AAA Legal Services**
Tartu Road 16
10117 Tallinn, Estonia
P.O. Box 3926
10509 Tallinn, Estonia
Phone: +372 660 5910
+372 660 5911
Fax: +372 660 5912
E-mail: aaa@aaa.ee
Http://www.aaa.ee
English, Russian, Finnish, Estonian
- Jüri OLT**
- Patent Agency Käosaar & Co**
Tähe Str. 94
50107 Tartu, Estonia
Phone: +372 738 3051
Fax: +372 738 3055
E-mail: info@kaosaar.ee
Http://www.kaosaar.ee
English, German, Finnish, Russian, Estonian
- Jaak OSTRAT**
- Lasvet Ltd.**
P.O. Box 3136
10505 Tallinn, Estonia
Phone: +372 640 6600
Fax: +372 640 6604
E-mail: lasvet@lasvet.ee
Http://www.lasvet.ee
English, German, Finnish, Russian, Estonian
- Villu PAVELTS**
- Lasvet Ltd.**
P.O. Box 3136
10505 Tallinn, Estonia
Phone: +372 640 6600
Fax: +372 640 6604
E-mail: lasvet@lasvet.ee
Http://www.lasvet.ee
English, Finnish, Russian, Estonian
- Toom PUNGAS**
- Synest Ltd.**
P.O. Box 977
13402 Tallinn, Estonia
Phone: +372 660 9786
Fax: +372 660 9787
E-mail: toom@synest.ee
English, German, Finnish, Russian, Estonian

