

EESTI VABARIIK

ISSN 1406-376X (trükiis)
ISSN 2228-3617 (võrguväljaanne)

T **EESTI**
TÖÖSTUSDISAINI-
LAHENDUSE LEHT



PATENDIAMETI AMETLIK VÄLJAANNE

4
2013
TALLINN

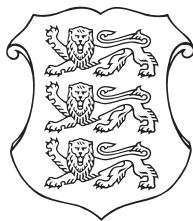

EESTI VABARIIK

ISSN 1406-376X (trükiis)
ISSN 2228-3617 (võrguväljaanne)

T

T **EESTI**
TÖÖSTUSDISAINI-
LAHENDUSE LEHT

**PATENDIAMETI
AMETLIK VÄLJAANNE**

XVI aastakäik

**Käesolevas numbris
esitatud andmed
loetakse avaldatuks
15. novembril 2013. a.**

4
2013
NOVEMBER
TALLINN

Eesti Tööstusdisainilahenduse Lehte antakse välja tööstusdisaini kaitse seaduse paragrahvi 55 lõike 3 alusel.

The Estonian Industrial Design Gazette is the official publication of the Estonian Patent Office published under § 33(3) of the Industrial Design Protection Act of the Republic of Estonia.

The data presented in this issue is deemed to be published on 15 November 2013.

Patendiameti
infoosakond
Toompuiestee 7
15041 Tallinn
Tel 627 7907
Faks 627 7943
E-post Info@epa.ee

The Information Department
of the Estonian Patent Office
Toompuiestee 7
15041 Tallinn, ESTONIA
Phone +372 627 7907
Fax+372 627 7943
E-mail Info@epa.ee

Levitaja

Eesti Intellektuaalomandi ja
Tehnoloogiasiirde Keskus
Teaduspargi 8
12618 Tallinn
Tel 641 1250
E-post patent@patentinfo.ee

Distributor

Estonian Intellectual Property and Technology
Transfer Centre
Teaduspargi 8
12618 Tallinn, ESTONIA
Phone +372 641 1250
E-mail patent@patentinfo.ee

SISUKORD

Andmete identifitseerimise rahvusvahelised numberkoodid (INID-koodid)	4
Riikide, teiste ühenduste ja valitsustevaheliste organisatsioonide koodid	5
I. REGISTREERITUD TÖÖSTUSDISAINILAHENDUSED	6
II. RAHVUSVAHELISELT REGISTREERITUD TÖÖSTUSDISAINILAHENDUSED	23
III. MUUD REGISTRIKANDED	36
Registreeringu kehtivuse pikendamine	36
Tööstusdisainilahenduse üleminek	-
Registreeringu jagamine	-
Registreeringu andmete muudatused	36
Registreeringu andmete parandused	-
Tööstusdisainilahenduse litsentsimine	-
Tööstusdisainilahenduse pantimine	-
Tööstusdisainilahenduse tunnistuse duplikaadi väljaandmine	-
Registreeringu kustutamine	36
IV. LOENDID	37
Registreeritud tööstusdisainilahenduste registreerimise taotluste numbriline loend	37
Rahvusvaheliselt registreeritud tööstusdisainilahenduste numbriline loend	37
V. TÖÖSTUSDISAINIALASED ÕIGUSAKTID JA MUU INFO	38
Riiklikus patendivolinike registris registreeritud patendivolinike nimekiri	38

CONTENTS

Internationally Agreed Numbers for the Identification of Data (INID Codes)	4
List of Codes of States, Other Entities and Intergovernmental Organizations	5
I. REGISTERED INDUSTRIAL DESIGNS	6
II. INTERNATIONALLY REGISTERED INDUSTRIAL DESIGNS	23
III. OTHER ENTRIES IN THE REGISTER	36
Extension of the Registration	36
Transfer of Industrial Design	-
Division of the Registration.	-
Amendments to Registration Data	36
Corrections to Registration Data	-
Licensing of Industrial Design	-
Pledging of Industrial Design	-
Issue of a Copy of the Industrial Design Certificate	-
Deletion of the Registration	36
IV. LISTS	37
Numerical List of Registration Applications of Registered Industrial Designs	37
Numerical List of Internationally Registered Industrial Designs	37
V. LEGAL ACTS AND INFORMATION CONCERNING INDUSTRIAL DESIGNS	38
List of Patent Attorneys, Registered in the Estonian State Register of Patent Attorneys	42

**ANDMETE IDENTIFITSEERIMISE
RAHVUSVAHELISED NUMBERKOODID
(INID-KOODID)
WIPO Standard ST. 80**

**INTERNATIONALLY AGREED NUMBERS FOR
THE IDENTIFICATION OF DATA
(INID CODES)
WIPO Standard ST. 80**

(11) Registreeringu number	(11) Number of the Registration
(15) Registreerimise kuupäev	(15) Date of the Registration
(18) Registreeringu kehtivuse lõppemise kuupäev	(18) Expected expiration date of the registration
(21) Registreerimistaotluse number	(21) Application Number
(22) Registreerimistaotluse esitamise kuupäev	(22) Application Filing Date
(24) Registreeringu kehtivuse alguse kuupäev	(24) Date from which the Industrial Design right has effected
(28) Variantide arv	(28) Number of Industrial Designs included in the application
(30) Prioriteet	(30) Priority
(51) Rahvusvahelise klassifikatsiooni klassi ja alaklassi number	(51) International Classification for Industrial Designs (class and subclass of the Locarno Classification)
(54) Tööstusdisainilahenduse nimetus	(54) Title of the Industrial Design
(55) Tööstusdisainilahenduse reproduktsioon	(55) Reproduction of the Industrial Design
(72) Tööstusdisainilahenduse autor(id)	(72) Author(s) of Industrial Design
(73) Tööstusdisainilahenduse omanik(ud)	(73) Proprietor(s) of Industrial Design
(74) Patendivolinik või ühine esindaja	(74) Patent Attorney or Common Representative

**RIIKIDE, TEISTE ÜHENDUSTE JA VALITSUSTEVAAHELISTE
ORGANISATSIOONIDE KOODID**
WIPO Standard ST. 3

AD	Andorra	EA	Euraasia Patendiorgani-	KH	Kambodža	RS	Serbia
AE	Araabia		satsioon (EAPO)	KI	Kiribati	RU	Venemaa
	Ühendemiraadid	EC	Ecuador	KM	Komoorid	RW	Rwanda
AF	Afganistan	EE	Eesti	KN	Saint Kitts ja Nevis	SA	Saudi Araabia
AG	Antigua ja Barbuda	EG	Egiptus	KP	Põhja-Korea	SB	Saalomoni Saared
AI	Anguilla	EH	Lääne-Sahara	KR	Lõuna-Korea	SC	Seišellid
AL	Albaania	EM	Siseturu Ühtlustamise	KW	Kuveit	SD	Sudaan
AM	Armeenia		Amet (kaubamärgid ja	KY	Kaimanisaared	SE	Rootsi
AO	Angola		tööstusdisainilahen-	KZ	Kasahstan	SG	Singapur
AP	Aafrika Regionaalne		dused) (OHIM)	LA	Laos	SH	Saint Helena, Ascension
	Tööstusomandi Orga-	EP	Euroopa	LB	Liibanon		ja Tristan da Cunha
	nisatsioon (ARIPO)		Patendiamet (EPO)	LC	Saint Lucia	SI	Sloveenia
AR	Argentina	ER	Eritrea	LI	Liechtenstein	SK	Slovakkia
AT	Austria	ES	Hispaania	LK	Sri Lanka	SL	Sierra Leone
AU	Austraalia	ET	Etiopia	LR	Libeeria	SM	San Marino
AW	Aruba	FI	Soome	LS	Lesotho	SN	Senegal
AZ	Aserbaidžaan	FJ	Fidži	LT	Leedu	SO	Somaalia
BA	Bosnia ja Hertsegoviina	FK	Falklandi (Malviini)	LU	Luksemburg	SR	Suriname
BB	Barbados		saared	LV	Läti	SS	Lõuna-Sudaan
BD	Bangladesh	FO	Fääri saared	LY	Liibüa	ST	São Tomé ja Príncipe
BE	Belgia	FR	Prantsusmaa	MA	Maroko	SV	El Salvador
BF	Burkina Faso	GA	Gabon	MC	Monaco	SX	Sint Maarten (Hollandi
BG	Bulgaaria	GB	Ühendkuningriik	MD	Moldova		osa)
BH	Bahrein		(Suurbritannia)	ME	Montenegro	SY	Süüria
BI	Burundi	GC	Pärsia Lahe	MG	Madagaskar	SZ	Svaasimaa
BJ	Benin		Koostöönõukogu	MK	Makedoonia	TC	Turks ja Caicos
BM	Bermuda	GD	Grenada	ML	Mali	TD	Tšaad
BN	Brunei	GE	Gruusia	MM	Myanmar (Birma)	TG	Togo
BO	Boliivia	GG	Guernsey	MN	Mongoolia	TH	Tai
BQ	Bonaire, Sint	GH	Ghana	MO	Macao	TJ	Tadžikistan
	Eustatius ja Saba	GI	Gibraltari	MP	Põhja-Mariaanid	TL	Ida-Timor
BR	Brasiilia	GL	Gröönimaa	MR	Mauritaania	TM	Türkmenistan
BS	Bahama	GM	Gambia	MS	Montserrat	TN	Tuneesia
BT	Bhutan	GN	Guinea	MT	Malta	TO	Tonga
BV	Bouvet' saar	GQ	Ekvatoriaal-Guinea	MU	Mauritius	TR	Türgi
BW	Botswana	GR	Kreeka	MV	Maldiivid	TT	Trinidad ja Tobago
BX	Beneluxi Kaubamärgi-	GS	Lõuna-Georgia ja	MW	Malawi	TV	Tuvalu
	amet (BBM) ja Beneluxi		Lõuna-Sandwichi	MX	Mehhiko	TW	Taiwan (Hiina provints)
	Tööstusdisainilahendus-		saared	MY	Malaisia	TZ	Tansaania
	te Amet (BBDM)	GT	Guatemala	MZ	Mosambiik	UA	Ukraina
BY	Valgevene	GW	Guinea-Bissau	NA	Namiibia	UG	Uganda
BZ	Belize	GY	Guyana	NE	Niger	US	Ameerika
CA	Kanada	HK	Hongkong	NG	Nigeeria		Ühendriigid
CD	Kongo Demokraatlik	HN	Honduras	NI	Nicaragua	UY	Uruguay
	Vabariik	HR	Horvaatia	NL	Holland	UZ	Usbekistan
CF	Kesk-Aafrika Vabariik	HT	Haiti	NO	Norra	VA	Vatikan (Püha Tool)
CG	Kongo	HU	Ungari	NP	Nepal	VC	Saint Vincent ja
CH	Šveits	IB	Maailma	NR	Nauru		Grenadiinid
CI	Côte d'Ivoire		Intellektuaalomandi	NZ	Uus-Meremaa	VE	Venezuela
CK	Cooki saared		Organisatsiooni (WIPO)	OA	Aafrika Intellektuaal-	VG	Neitsisaared
CL	Tšiili		Rahvusvaheline Büroo		omandi Organisatsioon	VN	Vietnam
CM	Kamerun	ID	Indoneesia		(OAPI)	VU	Vanuatu
CN	Hiina	IE	Iiri	OM	Omaan	WO	Maailma
CO	Kolumbia	IL	Iisrael	PA	Panama		Intellektuaalomandi
CR	Costa Rica	IM	Man'i saar	PE	Peruu		Organisatsioon (WIPO)
CU	Kuuba	IN	India	PG	Paapua Uus-Guinea		(Rahvusvaheline Büroo)
CV	Cabo Verde	IQ	Iraak	PH	Filipiinid	WS	Samoa
CW	Curaçao	IR	Iraan	PK	Pakistan	XN	Põhjamaade
CY	Küpros	IS	Island	PL	Poola		Patendiinstituut (PPI)
CZ	Tšehhi	IT	Itaalia	PT	Portugal	YE	Jeemen
DE	Saksamaa	JE	Jersey	PW	Belau	ZA	Lõuna-Aafrika Vabariik
DJ	Djibouti	JM	Jamaica	PY	Paraguay	ZM	Sambia
DK	Taani	JO	Jordaania	QA	Katar	ZW	Zimbabwe
DM	Dominica	JP	Jaapan	QZ	Ühenduse Sordiamet		
DO	Dominikaani Vabariik	KE	Kenya		(Euroopa Liit) (EÜSA)		
DZ	Alžeeria	KG	Kõrgõzstan	RO	Rumeenia		

I. REGISTREERITUD TÖÖSTUSDISAINILAHENDUSED

Avaldatakse "Tööstusdisaini kaitse seaduse" § 55¹ lõike 7 alusel.

Patendiamet ei ole kontrollinud tööstusdisainilahenduse uudsust ja eristatavust tulenevalt "Tööstusdisaini kaitse seaduse" § 31 lõike 2 punktist 1.

(11) Registreeringu number	01827	(51) Klass: 12-99
(21) Taotluse number	D201200073	
(15) Registreerimise päev	15.11.2013	
(22) Esitamise päev	02.10.2012	
(24) Registreeringu kehtivuse alguse päev	02.10.2012	
(18) Registreeringu kehtivuse lõppemise päev	02.10.2017	
(28) Variantide arv	2	
(72) Autor	Üllar Karro, Karitsa 30, Maardu, 74114 Harju maakond, EE	
(73) Omanik	Kelk ja Ratas OÜ, Silla 3, Rebala küla, 74222 Jõelähtme vald, Harjumaa, EE	
(74) Patendivolinik või ühine esindaja	Mart Enn Koppel	

(54) Nimetus **Ratastega käepide kelgule**

(55) Reproduktsoon

01827-1

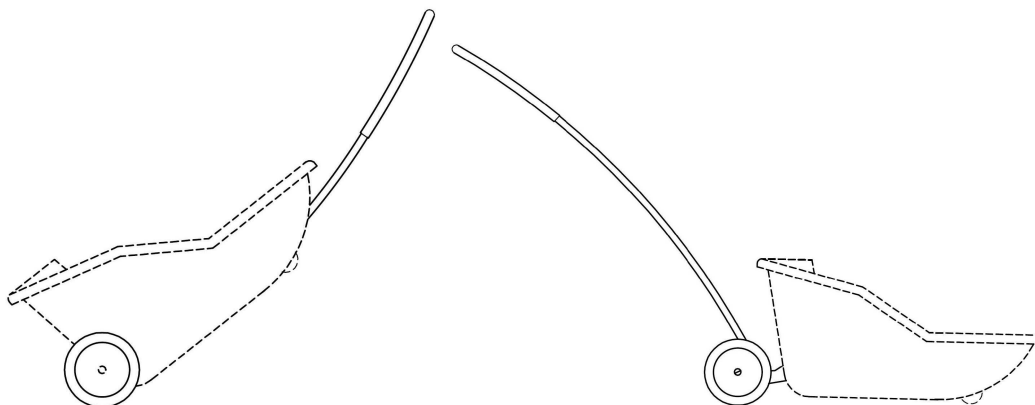
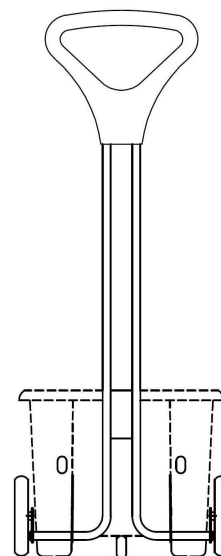
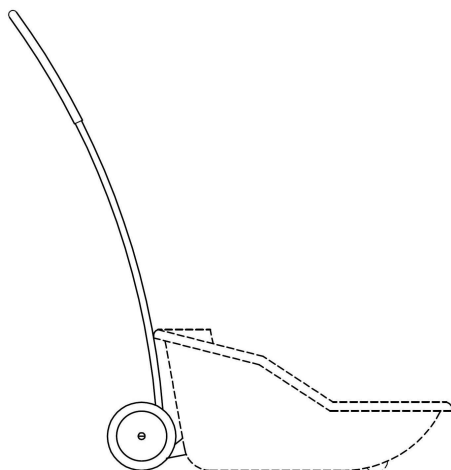
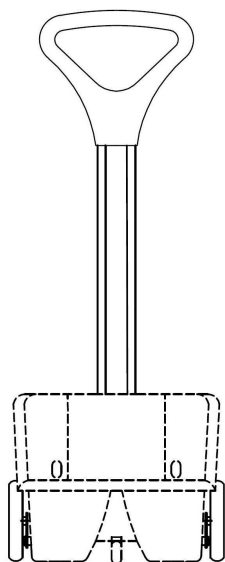

01827-2

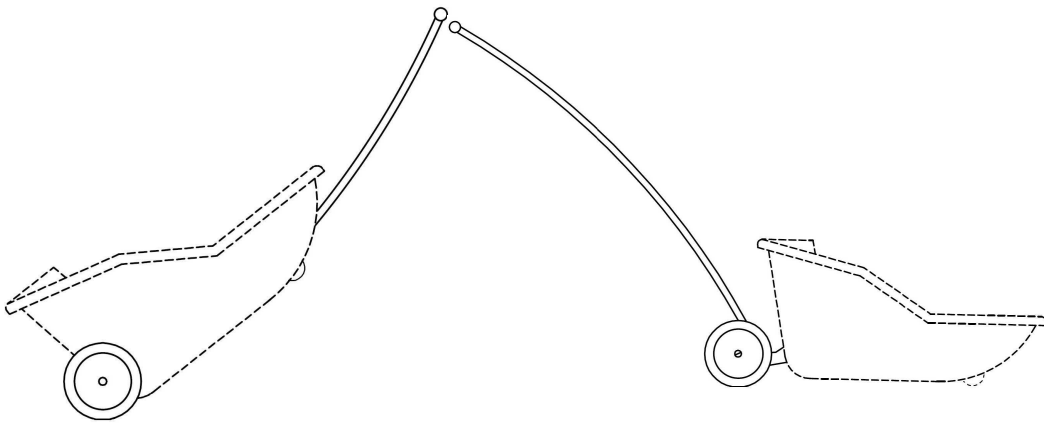
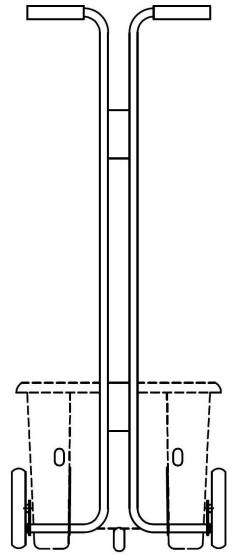
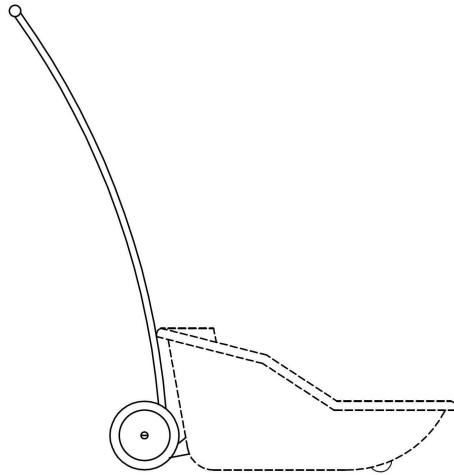
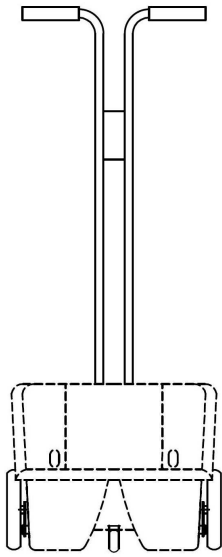

- (11) **Registreeringu number** **01828** (51) Klass: **09-01**
- (21) **Taotluse number** D201300038
- (15) **Registreerimise päev** 15.11.2013
- (22) **Esitamise päev** 12.07.2013
- (24) **Registreeringu kehtivuse alguse päev** 12.07.2013
- (18) **Registreeringu kehtivuse lõppemise päev** 12.07.2018
- (28) **Variantide arv** 1
- (72) **Autor** Tarmo Noop, Lauupeo pst 15, 50050 Tartu, EE
Rein Sööt, Lauupeo pst 15, 50050 Tartu, EE
Katrín Vernik, Lauupeo pst 15, 50050 Tartu, EE
Pilvi Tering, Lauupeo pst 15, 50050 Tartu, EE
Rando Mõrd, Lauupeo pst 15, 50050 Tartu, EE
Imbi Hepner, Tartu mnt 10, 10145 Tallinn, EE
Jaanus Vahtra, Tartu mnt 10, 10145 Tallinn, EE
- (73) **Omanik** AS A. Le Coq, Lauupeo pst 15, 50050 Tartu, EE
- (74) **Patendivolinik või ühine esindaja** Reet Maasikamäe

(54) **Nimetus** **Pudel**

(55) **Reproduktsoon**

01828-1

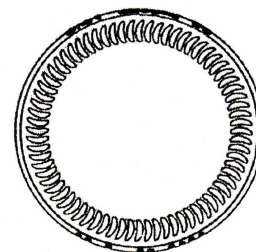
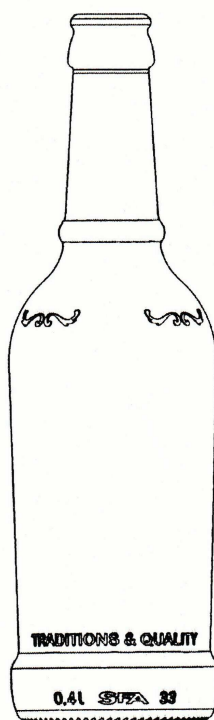

(11) **Registreeringu number** **01829**

(51) Klass: **25-02**

(21) **Taotluse number** D201300039

(15) **Registreerimise päev** 15.11.2013

(22) **Esitamise päev** 25.07.2013

(24) **Registreeringu kehtivuse
alguse päev** 25.07.2013

(18) **Registreeringu kehtivuse
lõppemise päev** 25.07.2018

(28) **Variantide arv** 1

(72) **Autor** Hannes Tarn, Vana Kalamaja 22-3, 10414 Tallinn, EE

(73) **Omanik** Bole OÜ, Lõuna 6B, Paldiski, 76805 Harju maakond, EE

(74) **Patendivolinik või ühine esindaja** Linnar Puusepp

(54) **Nimetus** **Põranda- või seinakatte moodul**

(55) **Reproduktsoon**

01829-1

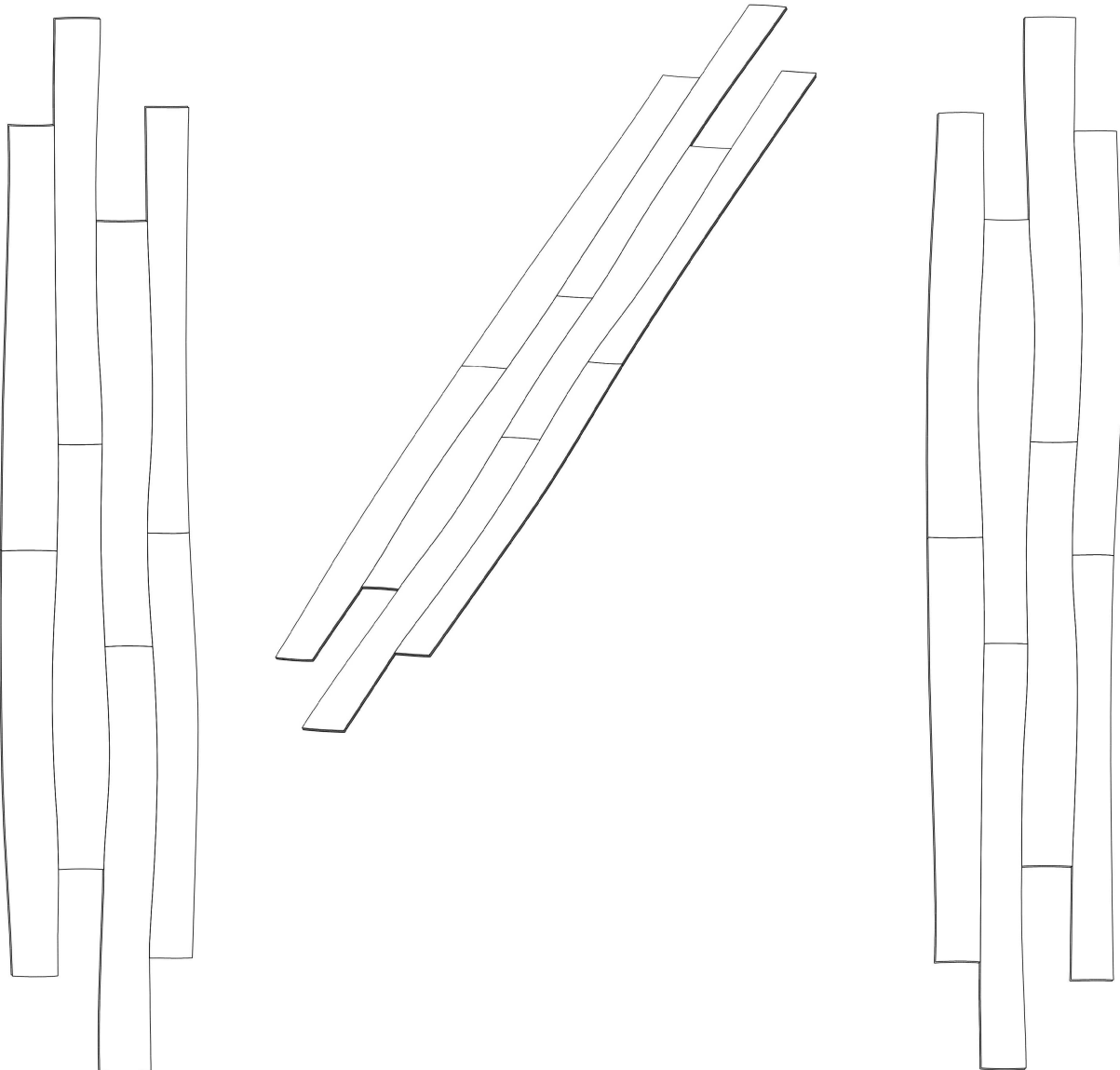

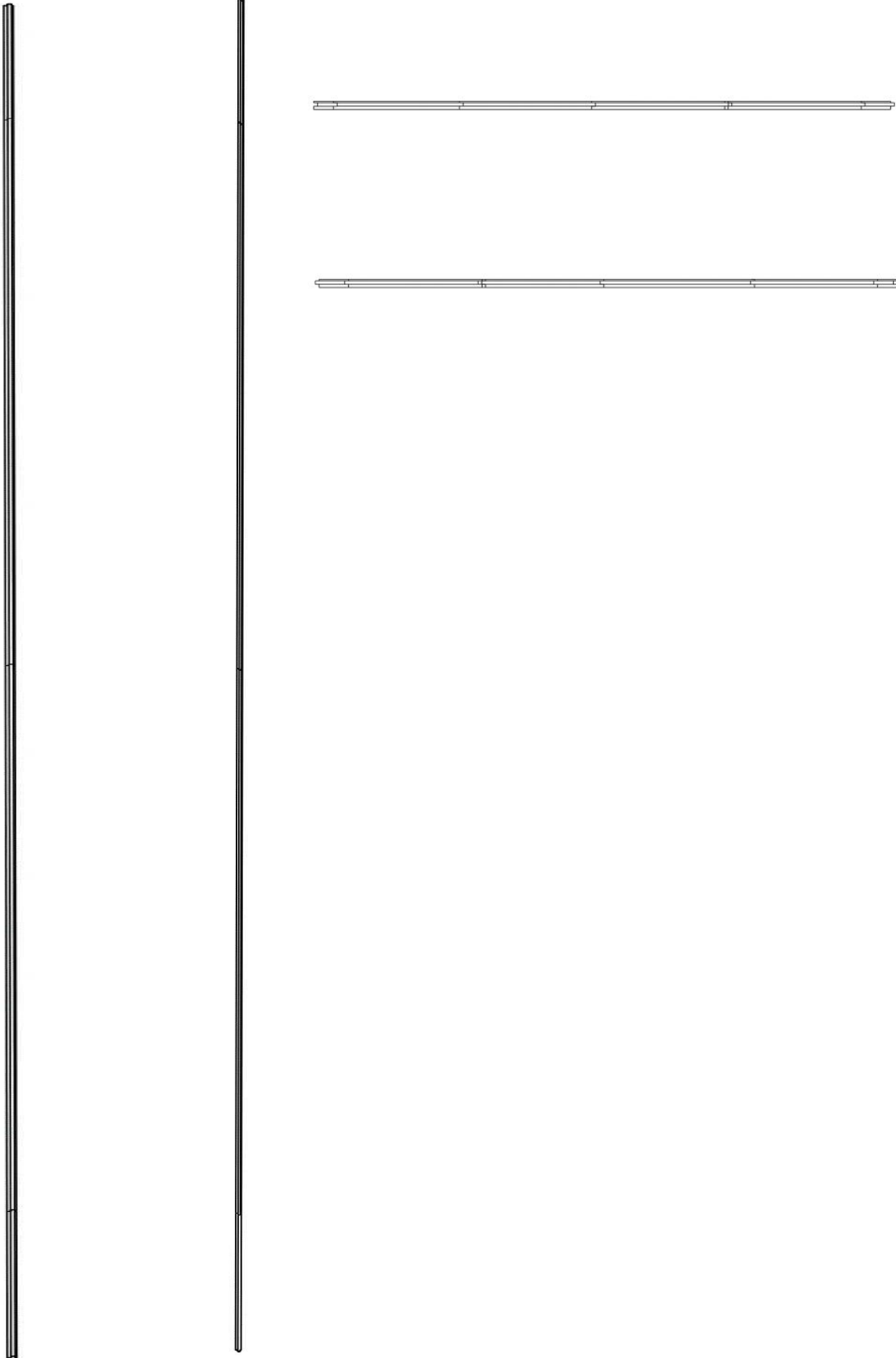

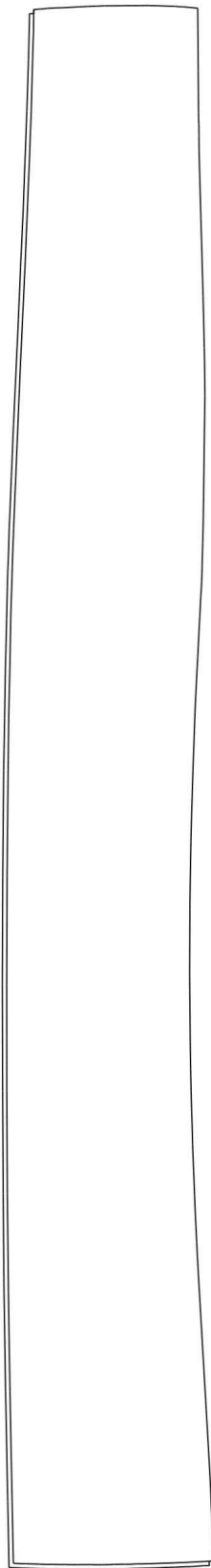
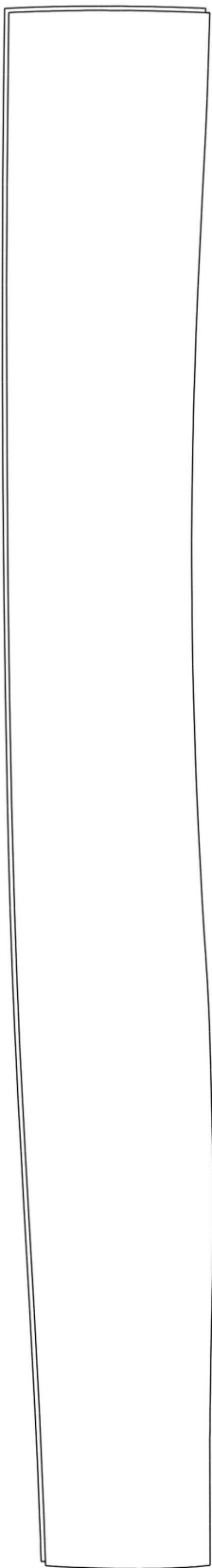

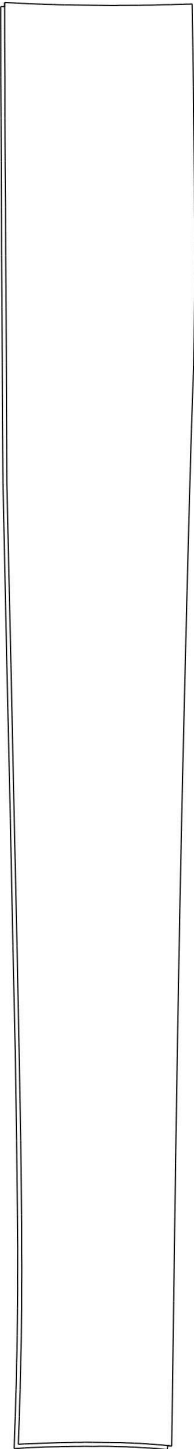
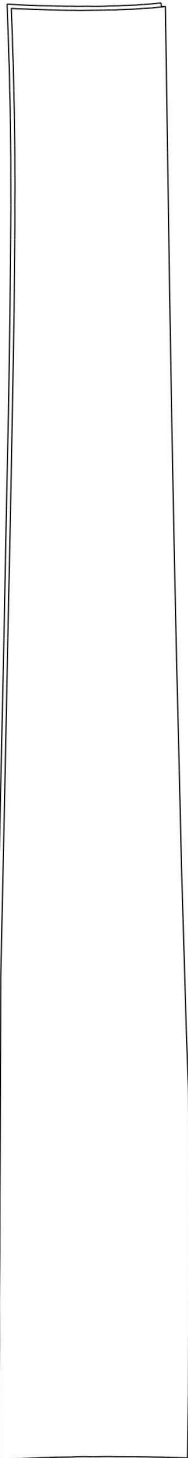
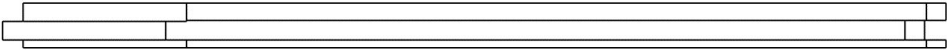
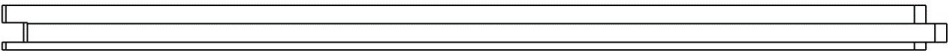

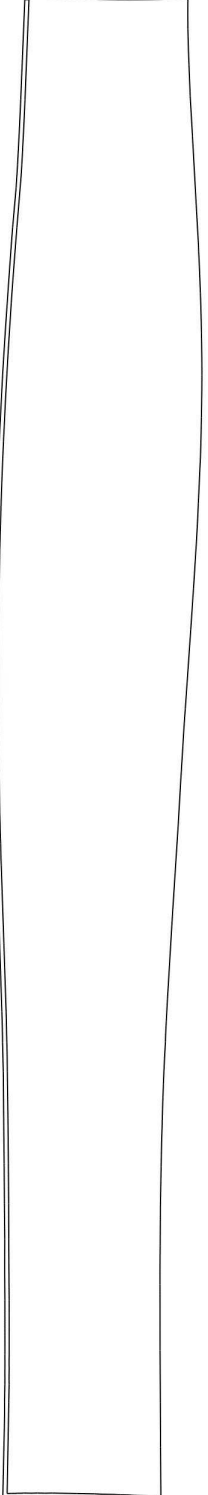
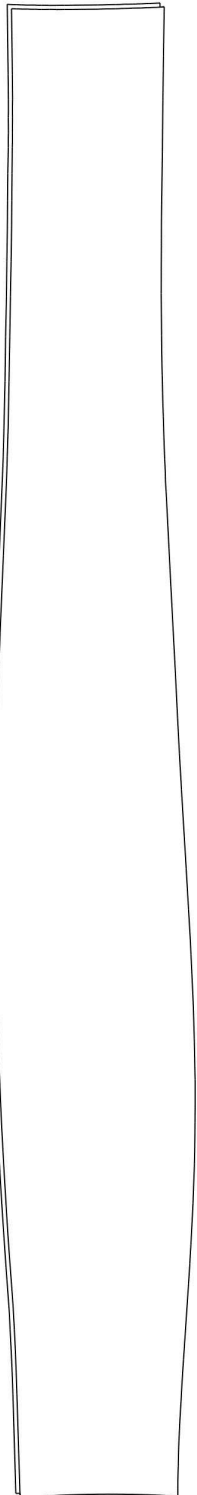
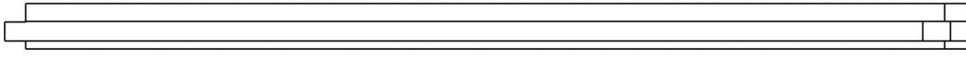
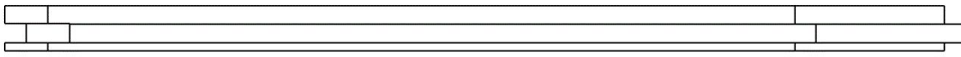

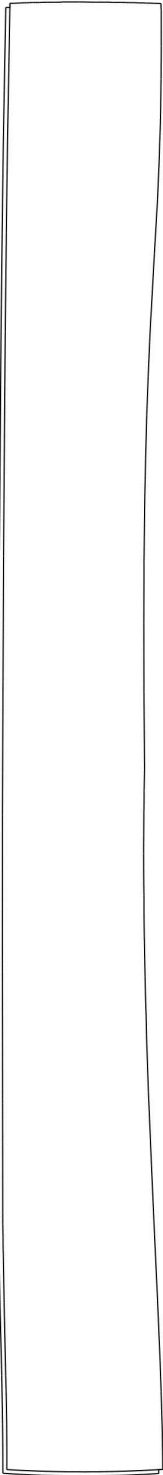
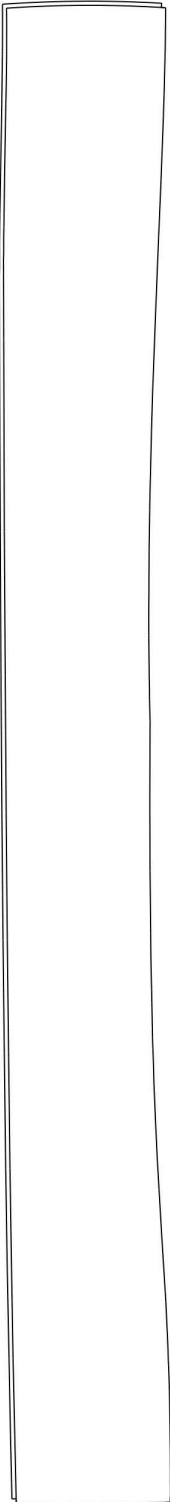
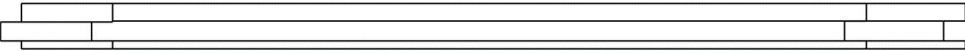
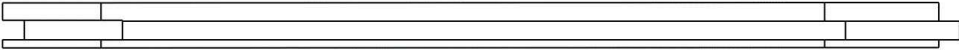

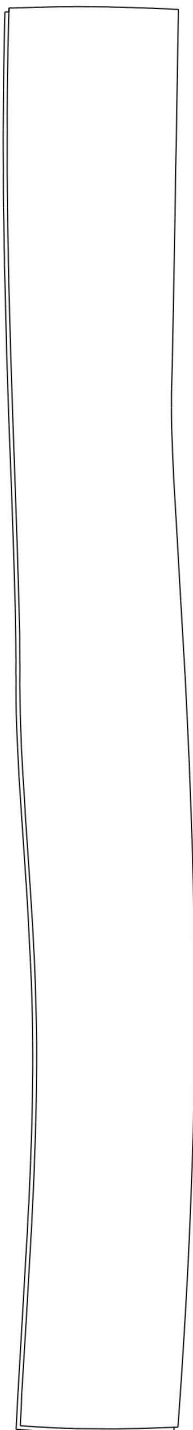
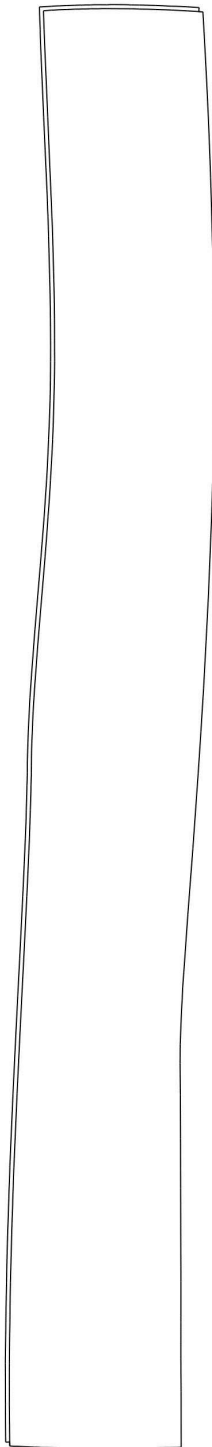
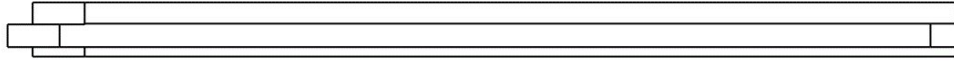
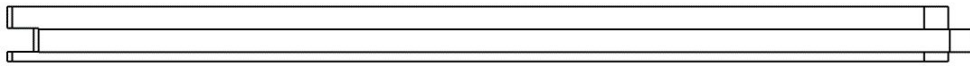

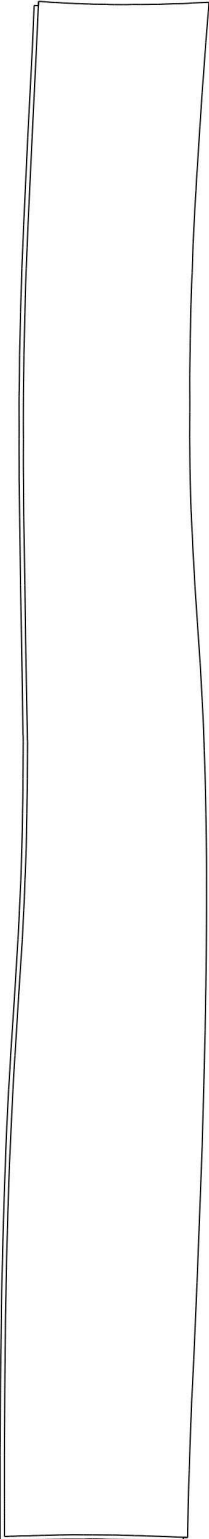
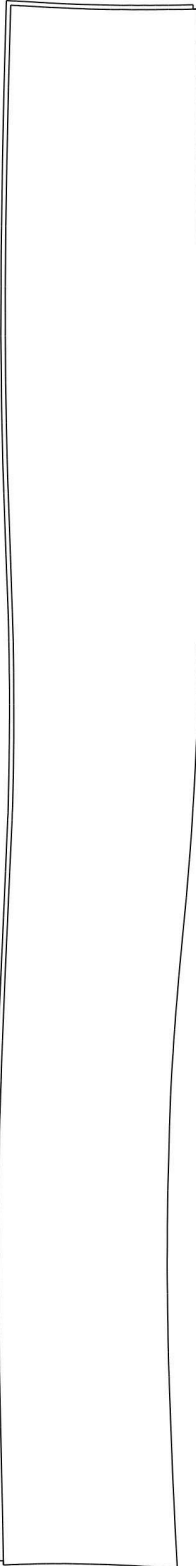
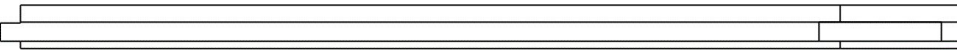
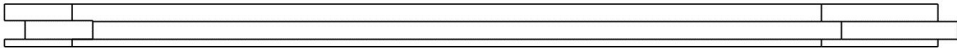

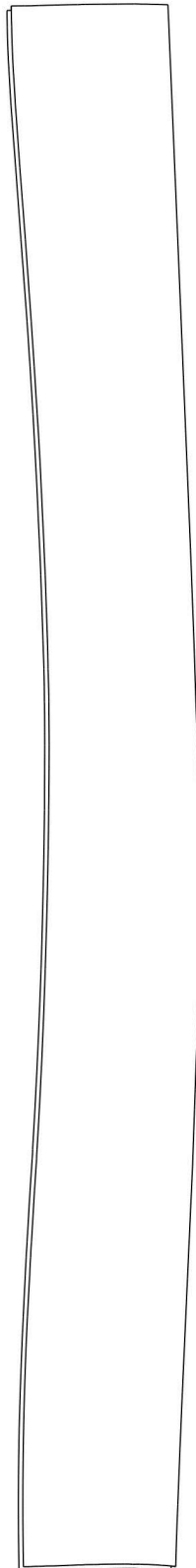
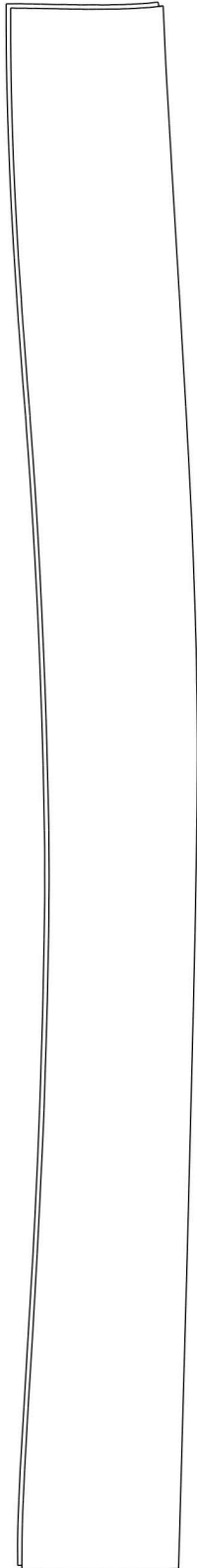
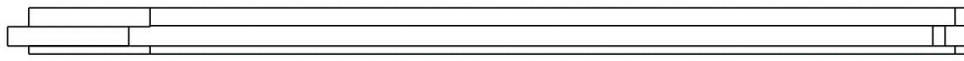
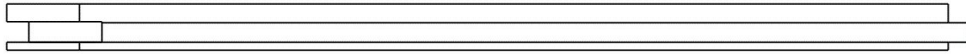

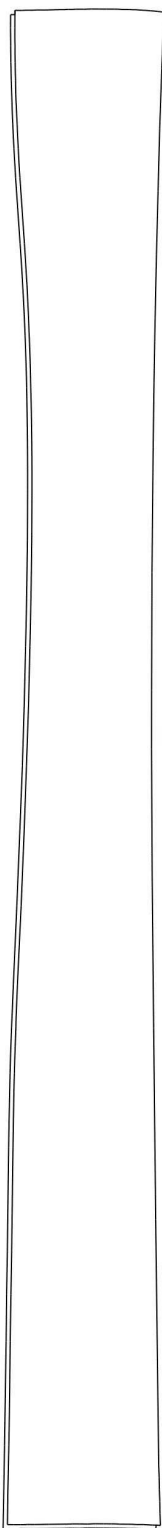
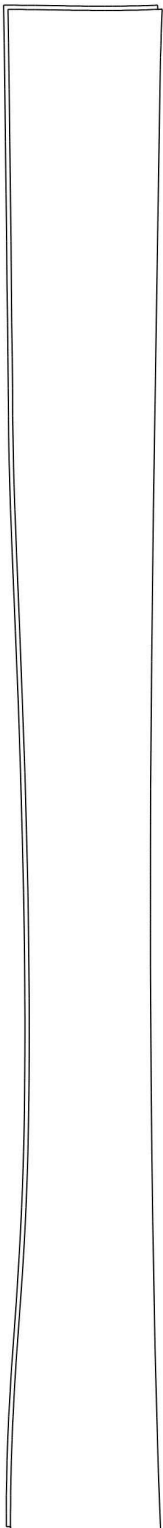
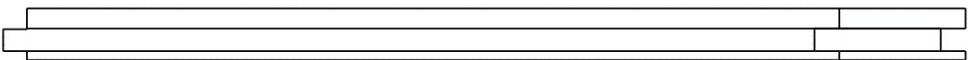
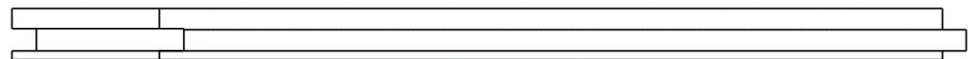

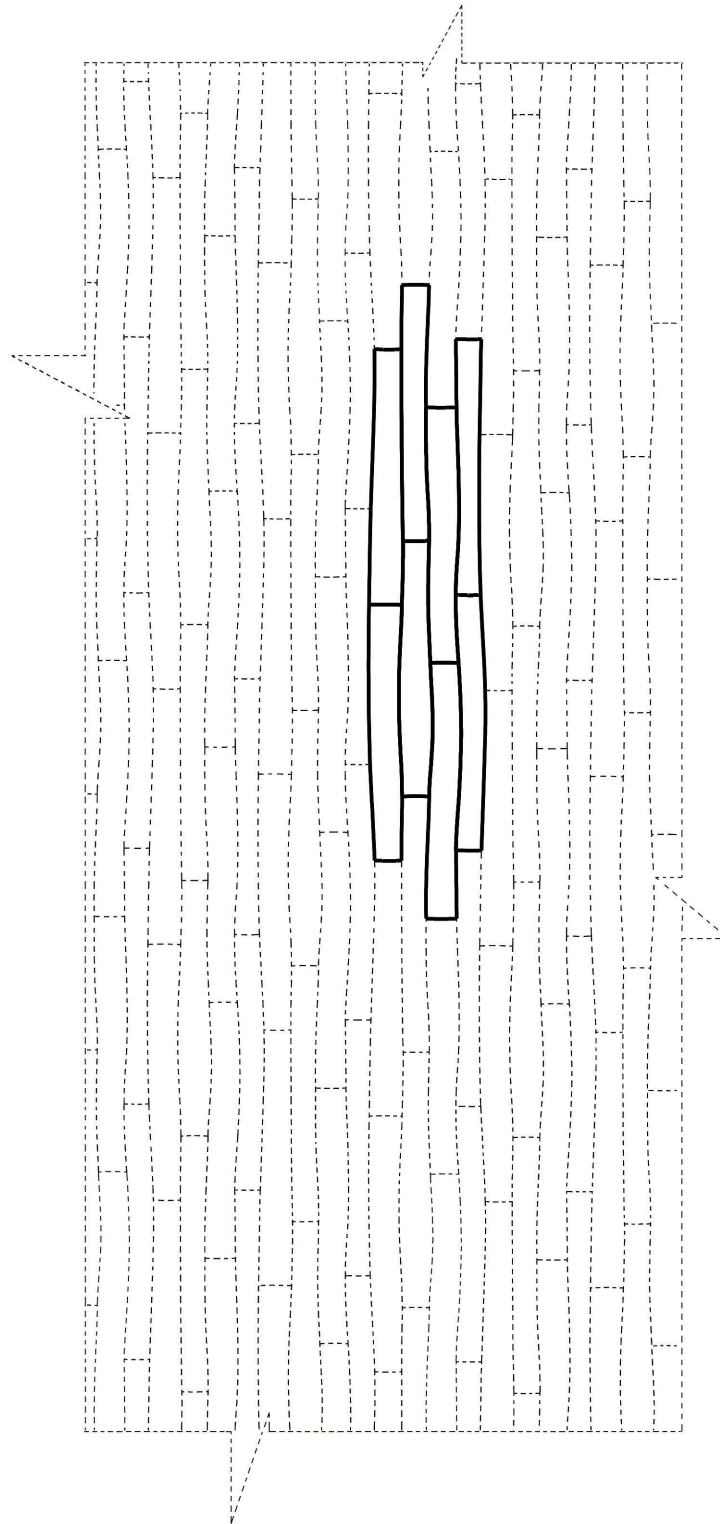
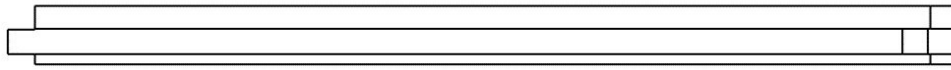
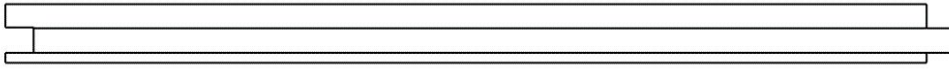

(11) Registreeringu number	01830	(51) Klass: 26-05
(21) Taotluse number	D201300040	
(15) Registreerimise päev	15.11.2013	
(22) Esitamise päev	13.08.2013	
(24) Registreeringu kehtivuse alguse päev	13.08.2013	
(18) Registreeringu kehtivuse lõppemise päev	13.08.2018	
(28) Variantide arv	4	
(72) Autor	<i>Autori andmeid ei avalikustata</i>	
(73) Omanik	Urmas Sarapuu, J. Vilmsi 32-15, 10126 Tallinn, EE	

(54) Nimetus **Valgusanum**

(55) Reproduktsoon

01830-1

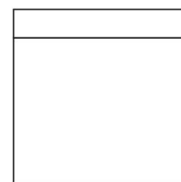
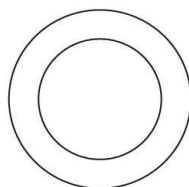

01830-2

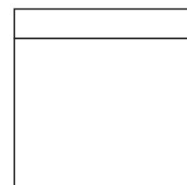
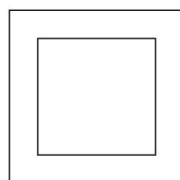
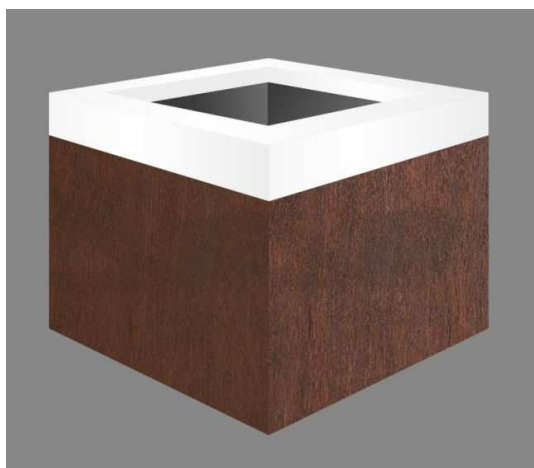

01830-3

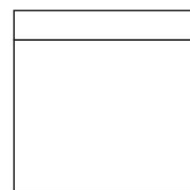
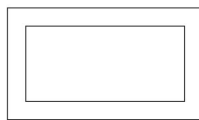

01830-4

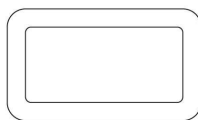

II. RAHVUSVAHELISELT REGISTREERITUD TÖÖSTUSDISAINILAHENDUSED

Avaldatakse "Tööstusdisaini kaitse seaduse" § 87⁴ lõike 3 alusel.

Patendiamet ei ole kontrollinud tööstusdisainilahenduse uudsust ja eristatavust tulenevalt "Tööstusdisaini kaitse seaduse" § 31 lõike 2 punktist 1.

(11) **Rahvusvah reg nr**

DM/078797

(51) Klass: **26-06**

(21) **Rahvusvah reg jrk**

H201300016

(15) **Registreeringu päev**

24.07.2012

(28) **Variantide arv**

1

(72) **Autor**

Eric Mornet
Christophe Dubosc
Pascal Garin

(73) **Omanik**

VALEO VISION, 34 rue Saint-André, F-93012 BOBIGNY Cedex, FR

**WIPO Rahvusvah Tööstusdisainilahenduste
Bülletääni nr, kus registreering on avaldatud**

29/2013

(55) **Reproduksioon**

DM/078797-1

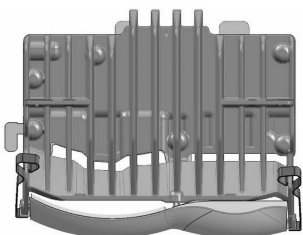
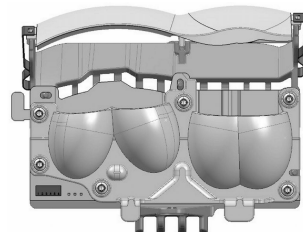
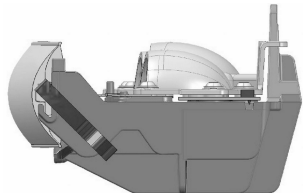
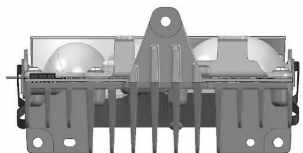
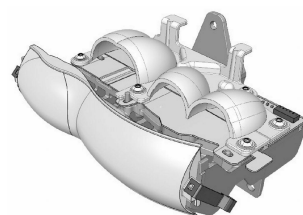
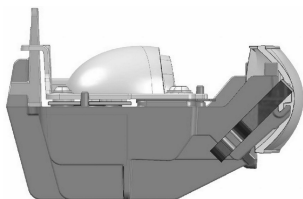
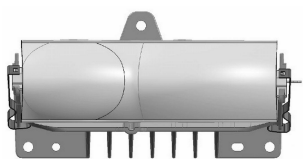

(11) **Rahvusvah reg nr**

DM/079266

(51) **Klass: 23-02**

(21) **Rahvusvah reg jrk**

H201300003

(15) **Registreeringu päev**

28.08.2012

(28) **Variantide arv**

1

(72) **Autor**

Garry Moore

(73) **Omanik**

Phoenix Product Development Limited, Unit 1 West Point, 11,
Durham Road, Basildon, Essex SS15 6PH, GB

**WIPO Rahvusvah Tööstusdisainilahenduste
Bülletääni nr, kus registreering on avaldatud**

08/2013

(55) **Reproduksioon**

DM/079266-1

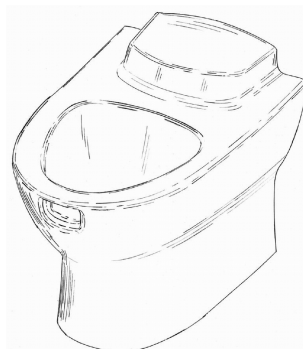
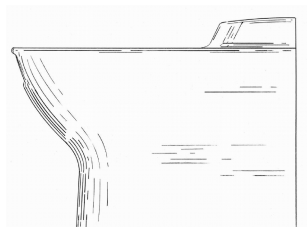
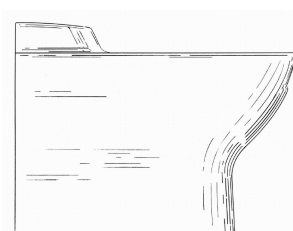
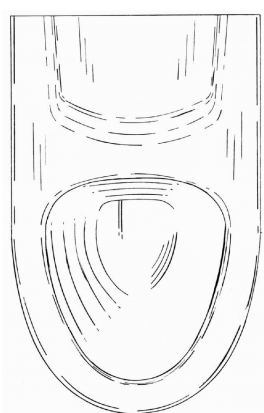
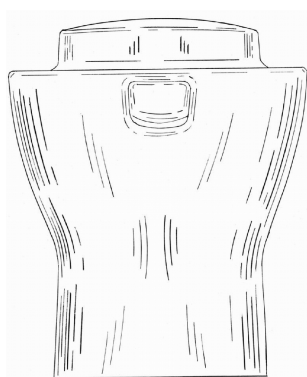

(11) **Rahvusvah reg nr**

DM/079946

(51) Klass: **12-08**

(21) **Rahvusvah reg jrk**

H201300010

(15) **Registreeringu päev**

14.01.2013

(28) **Variantide arv**

3

(72) **Autor**

Bertrand Hervé

(73) **Omanik**

Renault Trucks SAS, 99 route de Lyon, F-69800 Saint Priest, FR

WIPO Rahvusvah Tööstusdisainilahenduste

Bülletääni nr, kus registreering on avaldatud 28/2013

(55) **Reproduktsoon**

DM/079946-1

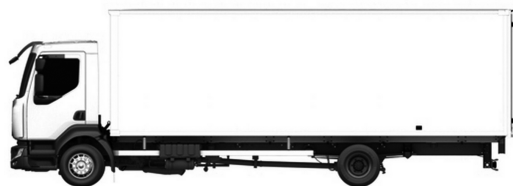

DM/079946-2





DM/079946-3



(11) **Rahvusvah reg nr**

DM/079947

(51) Klass: **08-06**

(21) **Rahvusvah reg jrk**

H201300011

(15) **Registreeringu päev**

14.01.2013

(28) **Variantide arv**

1

(72) **Autor**

Bertrand Hervé

(73) **Omanik**

Renault Trucks SAS, 99 route de Lyon, F-69800 Saint Priest, FR

WIPO Rahvusvah Tööstusdisainilahenduste

Bülletääni nr, kus registreering on avaldatud 28/2013

(55) **Reproduksioon**

DM/079947-1

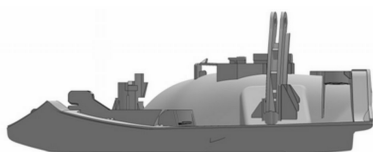
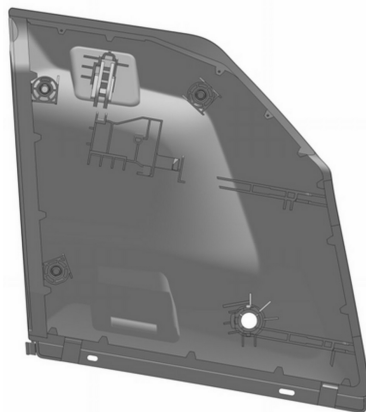
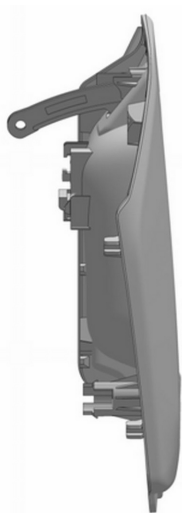
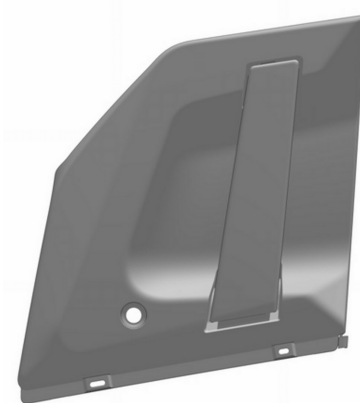
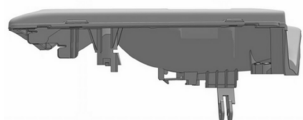

- (11) **Rahvusvah reg nr** DM/081139 (51) Klass: **26-06**
- (21) **Rahvusvah reg jrk** H201300008
- (15) **Registreeringu päev** 15.02.2013
- (28) **Variantide arv** 2
- (72) **Autor** Alan Jacq
Maxime Rasschaert
Zhi Zhong
Eric Moisy
- (73) **Omanik** VALEO VISION, 34 rue Saint-André, F-93012 BOBIGNY Cedex, FR
- WIPO Rahvusvah Tööstusdisainilahenduste**
Bülletääni nr, kus registreering on avaldatud 26/2013

(55) **Reproduktsoon**

DM/081139-1

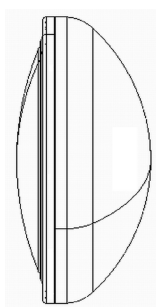
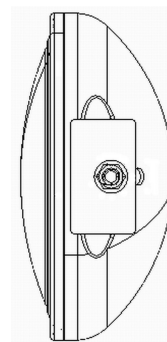
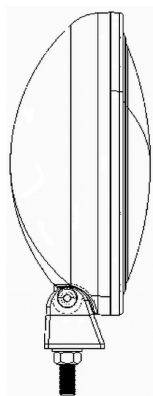
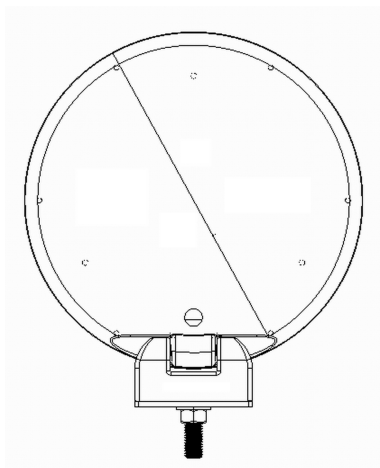
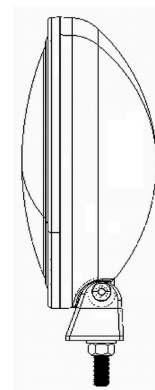
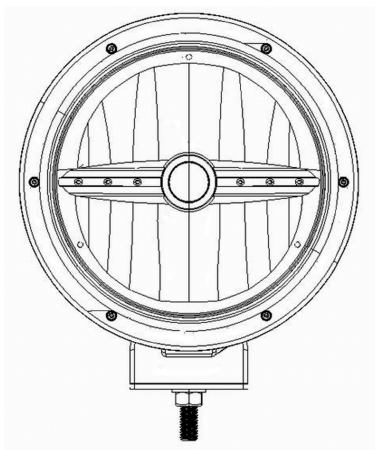
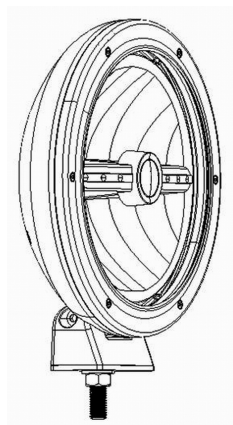

DM/081139-2



(11) **Rahvusvah reg nr**

DM/081140

(51) Klass: **26-06**

(21) **Rahvusvah reg jrk**

H201300009

(15) **Registreeringu päev**

15.02.2013

(28) **Variantide arv**

2

(72) **Autor**

Eric Moisy

(73) **Omanik**

VALEO VISION, 34 rue Saint-André, F-93012 BOBIGNY Cedex, FR

WIPO Rahvusvah Tööstusdisainilahenduste

Bülletääni nr, kus registreering on avaldatud 26/2013

(55) **Reproduktsoon**

DM/081140-1

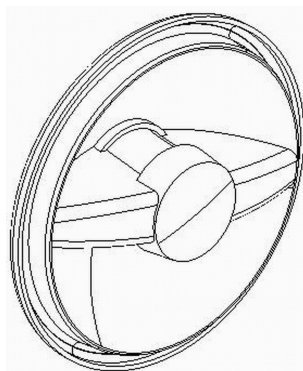
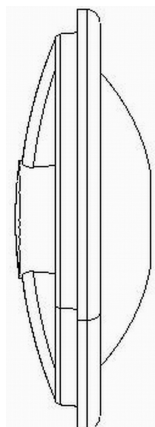
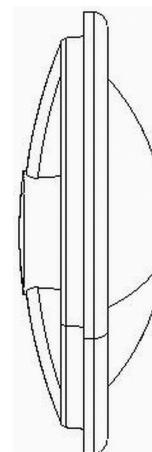
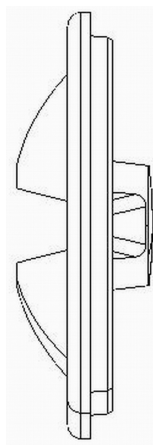
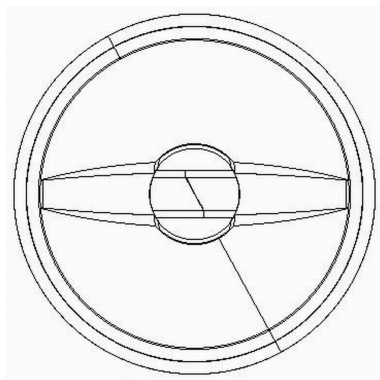
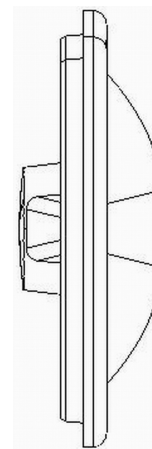
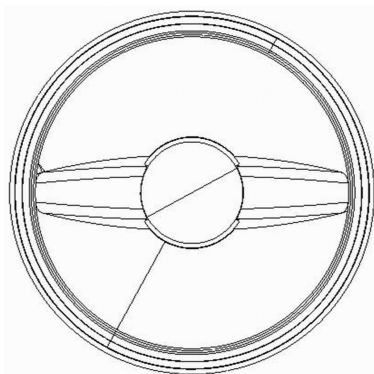
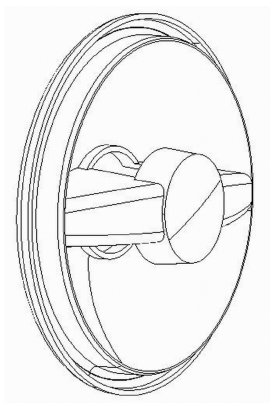

DM/081140-2



(11) Rahvusvah reg nr	DM/081328	(51) Klass: 11-01
(21) Rahvusvah reg jrk	H201300017	
(15) Registreeringu päev	13.12.2012	
(28) Variantide arv	1	
(72) Autor	Lloyd Karl Kleivene	
(73) Omanik	Lloyd Kleivene, Gjørbrøndveien 68, N-4886 Grimstad, NO	
WIPO Rahvusvah Tööstusdisainilahenduste Bülletääni nr, kus registreering on avaldatud	29/2013	

(55) **Reproduksioon**

DM/081328-1



(11) **Rahvusvah reg nr**

DM/081465

(51) Klass: **26-06**

(21) **Rahvusvah reg jrk**

H201300018

(15) **Registreeringu päev**

06.08.2013

(28) **Variantide arv**

2

(72) **Autor**

Alan Jacq
Maxime Rasschaert

Zhi Zhong

Eric Moisy

Laurent Sauzay

VALEO VISION, 34 rue Saint-André, F-93012 BOBIGNY Cedex, FR

(73) **Omanik**

WIPO Rahvusvah Tööstusdisainilahenduste

Bülletääni nr, kus registreering on avaldatud 32/2013

(55) **Reproduktsoon**

DM/081465-1

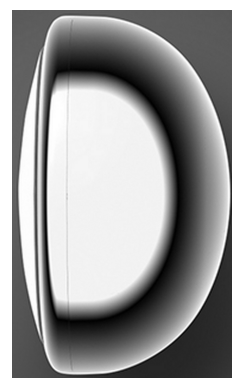
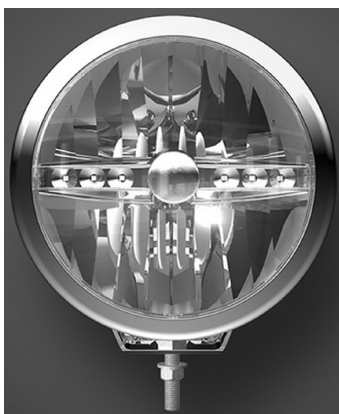
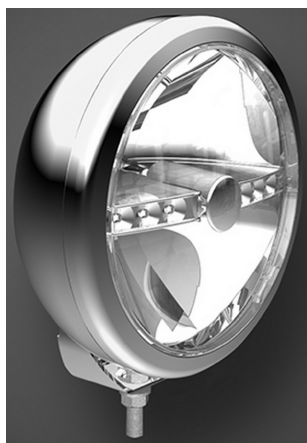

DM/081465-2

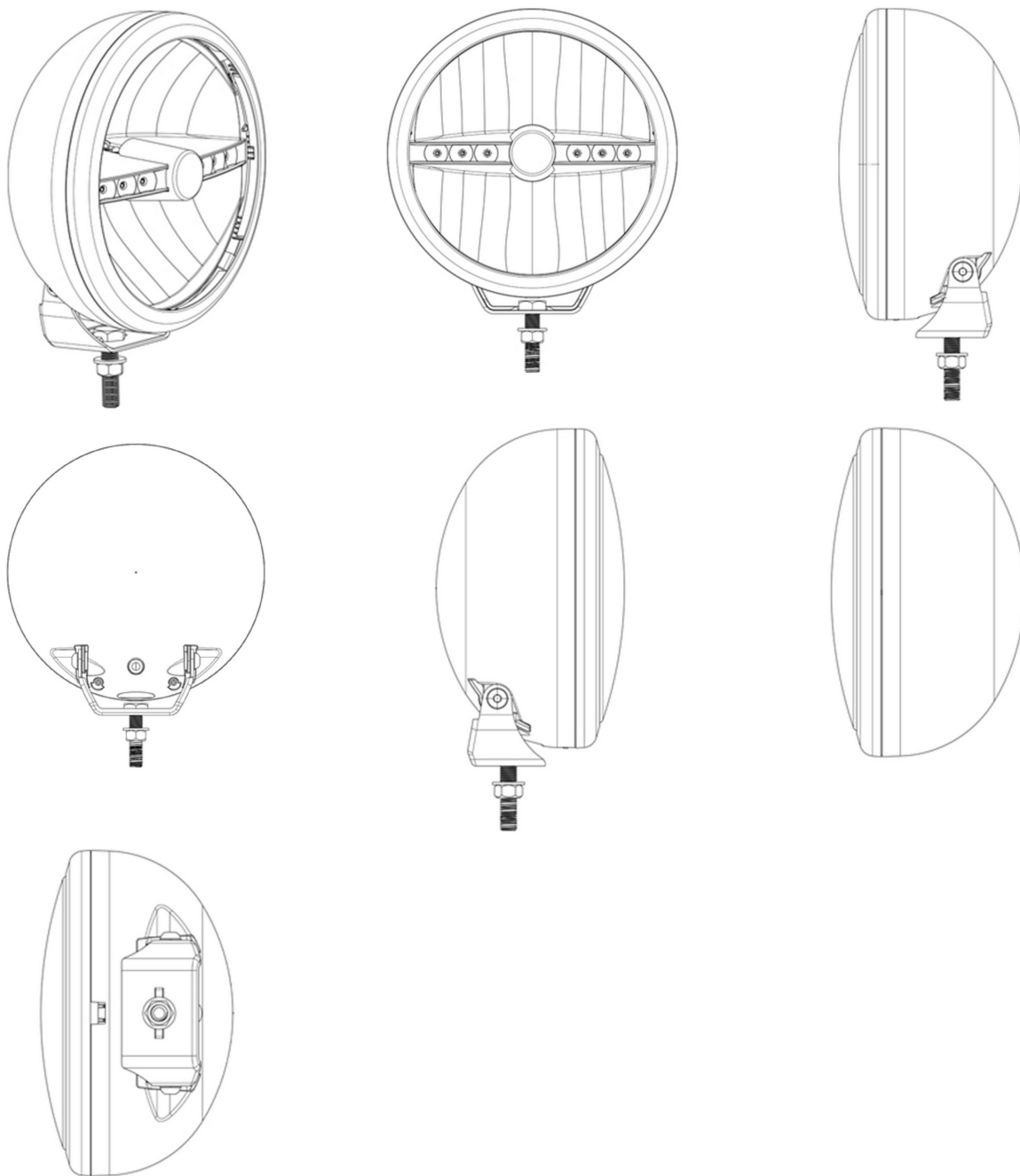

III. MUUD REGISTRIKANDED

REGISTREERINGU KEHTIVUSE PIKENDAMINE

Reg nr	Registreeringu pikendatud kehtivusaja lõppemise päev
--------	--

(11)	(18)
00304	12.08.2018
00305	12.08.2018
00309	18.09.2018
00310	18.09.2018
00311	22.09.2018
00338	10.12.2018
00881	11.11.2018
00929	11.11.2018
01491	01.09.2018
01500	21.11.2018
01551	28.10.2018

REGISTREERINGU ANDMETE MUUDATUSED

Reg nr	Muutunud andmed	Registrikande jõustumise päev
01500	Vecly OÜ, Maisi 8-1, 10317 Tallinn, EE	12.09.2013

REGISTREERINGU KUSTUTAMINE

"Tööstusdisaini kaitse seaduse" paragrahvi 77 lõike 1 alusel on registrist kustutatud järgmised tööstusdisainilahendused:

Reg nr	Kustutamise kande jõustumise päev
--------	-----------------------------------

00228	09.04.2013	00793	03.03.2013	01417	04.02.2013
00230	09.04.2013	00797	06.03.2013	01418	17.03.2013
00232	22.04.2013	00798	10.03.2013	01420	27.12.2012
00233	22.04.2013	00802	06.03.2013	01421	27.12.2012
00234	23.04.2013	00803	06.03.2013	01422	27.12.2012
00768	23.12.2012	00804	06.03.2013	01423	27.12.2012
00769	23.12.2012	00805	06.03.2013	01424	04.01.2013
00770	23.12.2012	00806	06.03.2013	01425	14.01.2013
00771	23.12.2012	00807	06.03.2013	01426	20.02.2013
00772	23.12.2012	00808	25.03.2013	01427	01.03.2013
00779	25.02.2013	00854	15.04.2013	01428	14.03.2013
00782	06.03.2013	00859	06.03.2013	01429	14.03.2013
00783	06.03.2013	01408	04.01.2013	01430	14.03.2013
00784	06.03.2013	01409	07.01.2013	01431	09.04.2013
00785	06.03.2013	01410	11.01.2013	01432	09.04.2013
00787	13.03.2013	01411	11.01.2013	01433	09.04.2013
00788	13.03.2013	01413	16.01.2013	01444	01.03.2013
00789	13.03.2013	01414	16.01.2013	01445	01.03.2013
00790	13.03.2013	01415	16.01.2013	01446	14.03.2013
00792	26.02.2013	01416	04.02.2013	01447	22.04.2013

IV. LOENDID**REGISTREERITUD TÖÖSTUSDISAINILAHENDUSTE REGISTREERIMISE TAOTLUSTE
NUMBRILINE LOEND**

Registreerimis- taotluse number	Registreeringu number
------------------------------------	--------------------------

D201200073	01827
D201300038	01828
D201300039	01829
D201300040	01830

**RAHVUSVAHELISELT REGISTREERITUD TÖÖSTUSDISAINILAHENDUSTE
NUMBRILINE LOEND**

Rahvusvah reg jrk	Rahvusvah reg nr
-------------------	------------------

H201300003	DM/079266	H201300011	DM/079947
H201300008	DM/081139	H201300016	DM/078797
H201300009	DM/081140	H201300017	DM/081328
H201300010	DM/079946	H201300018	DM/081465

V. TÖÖSTUSDISAINIALASED ÕIGUSAKTID JA MUU INFO

RIIKLIKUS PATENDIVOLNIKE REGISTRIS REGISTREERITUD PATENDIVOLNIKE NIMEKIRI (seisuga 29. oktoober 2013)

Register on asutatud 1. septembril 2001. a Vabariigi Valitsuse 7. augusti 2001. a määrusega nr 271 "Riikliku patendivolinike registri asutamine ja registri pidamise põhimäärus" (RT I 2001, 70, 426) patendivoliniku seaduse § 21 alusel (RT I 2001, 27, 151).

TEGEVUSVALDKOND: KAUBAMÄRK, TÖÖSTUSDISAINILAHENDUS JA GEOGRAAFILINE TÄHIS

Arno ANIJALG	Patendibüroo Ustervall OÜ Kivi 21-6 51009 Tartu telefon: 744 1980 telefaks: 744 1785 e-post: anijalg@ustervall.ee http://www.ustervall.ee võõrkeeled: saksa, vene	Juhan HÄMMALOV	INTELS Patendibüroo OÜ Magasini 12 51005 Tartu telefon: 742 0401 telefaks: 742 0326 e-post: intels@intels.ee http://www.intels.ee võõrkeeled: inglise, saksa, vene
Aivo ARULA	Patendibüroo Käosaar & Co OÜ Tähe 94 50107 Tartu telefon: 738 3051 telefaks: 738 3055 e-post: info@kaosaar.ee http://www.kaosaar.ee võõrkeeled: inglise, vene	Martin JÕGI	LASVET Patendibüroo OÜ Suurtüki 4a, 10133 Tallinn telefon: 640 6600 telefaks: 640 6604 e-post: lasvet@lasvet.ee http://www.lasvet.ee võõrkeeled: soome, vene, inglise
Martina BÖCKLER-LORVI	LASVET Patendibüroo OÜ Suurtüki 4a, 10133 Tallinn pk 3136, 10505 Tallinn telefon: 640 6600 telefaks: 640 6604 e-post: lasvet@lasvet.ee http://www.lasvet.ee võõrkeeled: inglise, soome	Uno JÄÄGER	Inseneribüroo Uneko OÜ Rüütli 51a, 80010 Pärnu telefon: 447 1021 telefaks: 447 1001 GSM: 515 1844 e-post: info@uneko.ee http://www.uneko.ee võõrkeeled: inglise, soome, vene
Indrek EELMETS	Advokaadibüroo SORAINEN AS Pärnu mnt 15 10141 Tallinn telefon: 640 0900 telefaks: 640 0901 e-post: estonia@sorainen.com http://www.sorainen.com võõrkeeled: inglise, vene, soome	Sirje KAHU	Patendibüroo Ustervall OÜ Kivi 21-6 51009 Tartu telefon: 744 1980 telefaks: 744 1785 e-post: skahu@ustervall.ee http://www.ustervall.ee võõrkeeled: inglise, vene
Alla HÄMMALOV	INTELS Patendibüroo OÜ Magasini 12 51005 Tartu telefon: 742 0401 telefaks: 742 0326 e-post: intels@intels.ee http://www.intels.ee võõrkeeled: inglise, poola, vene	Lembit KALEV	Patendibüroo ROOSILLA OÜ Järveotsa tee 39-61 13520 Tallinn telefon: 657 1722, 657 5381 telefaks: 657 5381 GSM: 511 9951 e-post: roosilla@roosilla.ee http://www.roosilla.ee võõrkeeled: inglise, vene

- Anneli KANG** **OÜ Synest**
pk 977, 13402 Tallinn
telefon: 660 9786
telefaks: 660 9787
e-post: anneli@synest.ee
võõrkeeled: inglise, saksa, vene,
prantsuse, soome, rootsi
- Anneli KAPP** **Patendibüroo Käosaar & Co OÜ**
Tähe 94
50107 Tartu
telefon: 738 3051
telefaks: 738 3055
e-post: info@kaosaar.ee
http://www.kaosaar.ee
võõrkeeled: inglise, vene
- Urmas KAULER** **Patendibüroo TURVAJA OÜ**
Liivalaia 22
10118 Tallinn
telefon: 640 3109
telefaks: 640 3105
e-post: turvaja@turvaja.ee
http://www.turvaja.ee
võõrkeeled: inglise, vene, soome
- Urmas KERNU** **AAA Patendibüroo OÜ**
Tartu mnt 16
10117 Tallinn
pk 3926, 10509 Tallinn
telefon: 660 5910, 660 5911
telefaks: 660 5912
e-post: aaa@aaa.ee
http://www.aaa.ee
võõrkeeled: inglise, saksa,
soome, vene
- Ljubov KESSELMAN** **OÜ Kesna**
Tedre 77-52
10616 Tallinn
telefon: 660 8068
telefaks: 660 8069
e-post: kesna@kesna.ee
http://www.kesna.ee
võõrkeeled: inglise, vene
- Marina KESSELMAN** **OÜ Kesna**
Tedre 77-52
10616 Tallinn
telefon: 660 8068
telefaks: 660 8069
e-post: kesna@kesna.ee
http://www.kesna.ee
võõrkeeled: inglise, saksa, vene
- Raivo KOITEL**
- Katrin KOITEL-VEIDIK**
- Mart Enn KOPPEL**
- Anna KOSAR**
- Heinrich KRUPP**
- Jüri KÄOSAAR**
- Patendi- & Kaubamärgibüroo Koitel OÜ**
Tartu mnt 65
10115 Tallinn
pk 1759, 10902 Tallinn
telefon: 603 3260
telefaks: 603 3261
e-post: koitel@koitel.ee
http://www.koitel.ee
võõrkeeled: inglise, soome, vene
- Patendi- & Kaubamärgibüroo Koitel OÜ**
Tartu mnt 65
10115 Tallinn
pk 1759, 10902 Tallinn
telefon: 603 3260
telefaks: 603 3261
e-post: koitel@koitel.ee
http://www.koitel.ee
võõrkeeled: inglise, soome
- KOPPEL patendibüroo OÜ**
Roseni 10-151
10111 Tallinn
telefon: 677 4136
telefaks: 677 4138
e-post: info@koppelpb.com
http://www.koppelpb.com
võõrkeeled: inglise, vene, soome
- Patendi- & Kaubamärgibüroo Koitel OÜ**
Tartu mnt 65
10115 Tallinn
pk 1759, 10902 Tallinn
telefon: 603 3260
telefaks: 603 3261
e-post: koitel@koitel.ee
http://www.koitel.ee
võõrkeeled: inglise, vene
- Patendibüroo TURVAJA OÜ**
Liivalaia 22
10118 Tallinn
telefon: 640 3109
telefaks: 640 3105
e-post: turvaja@turvaja.ee
http://www.turvaja.ee
võõrkeeled: saksa, vene
- Patendibüroo Käosaar & Co OÜ**
Tähe 94
50107 Tartu
telefon: 738 3051
telefaks: 738 3055
e-post: info@kaosaar.ee
http://www.kaosaar.ee
võõrkeeled: inglise, vene

Kalev KÄOSAAR	Patendibüroo Käosaar & Co OÜ Suur-Patarei 2 10415 Tallinn telefon: 637 9484 telefaks: 637 9485 e-post: kalev.kaosaar@kaosaar.ee http://www.kaosaar.ee võõrkeeled: inglise, vene	Lembit MITT	AAA Patendibüroo OÜ Tartu mnt 16, 10117 Tallinn pk 3926, 10509 Tallinn telefon: 660 5910, 660 5911 telefaks: 660 5912 e-post: aaa@aaa.ee http://www.aaa.ee võõrkeeled: inglise, vene
Kärt LAIGU	kutsetegevus on peatatud	Ott MOORLAT	OÜ Moorlat & Ko Patendibüroo pk 4730, 13503 Tallinn telefon: 648 2085 telefaks: 654 2844 e-post: ott.moorlat@moorlat.ee http://www.moorlat.ee võõrkeeled: inglise, vene
Kristjan LEPPIK	Patendibüroo TURVAJA OÜ Liivalaia 22 10118 Tallinn telefon: 640 3109 telefaks: 640 3105 e-post: turvaja@turvaja.ee http://www.turvaja.ee võõrkeeled: inglise, vene	Anfia MORNA	Patendibüroo TURVAJA OÜ Liivalaia 22, 10118 Tallinn telefon: 640 3109 telefaks: 640 3105 e-post: turvaja@turvaja.ee http://www.turvaja.ee võõrkeeled: inglise, vene
Reet MAASIKAMÄE	Patendibüroo Kaitsepurus OÜ Mulla 4-3 10611 Tallinn telefon: 673 9097, 566 75197 telefaks: 677 4844 e-post: purus@kaitsepurus.ee http://www.kaitsepurus.ee võõrkeeled: inglise, vene	Mari MUST	Raidla Lejins & Norcoux Advokaadibüroo OÜ Roosikrantsi 2, 10119 Tallinn telefon: 640 7170 telefaks: 640 7171 e-post: mari.must@rln.ee http://www.rln.ee võõrkeeled: inglise, soome
Ingrid MATSINA	AAA Patendibüroo OÜ Tartu mnt 16, 10117 Tallinn pk 3926, 10509 Tallinn telefon: 660 5910, 660 5911 telefaks: 660 5912 e-post: aaa@aaa.ee http://www.aaa.ee võõrkeeled: inglise, vene, saksa, prantsuse	Tõnu NELNAS	AAA Patendibüroo OÜ Tartu mnt 16, 10117 Tallinn pk 3926, 10509 Tallinn telefon: 660 5910, 660 5911 telefaks: 660 5912 e-post: aaa@aaa.ee http://www.aaa.ee võõrkeeled: inglise, vene, soome
Raivo MATSOO	RM Hirvela Patendibüroo OÜ Endla 3, 10122 Tallinn telefon: 614 0816 telefaks: 614 0818 e-post: hirvela@hirvela.ee võõrkeeled: inglise, vene	Jüri OLT	Danteks OÜ Kalda tee 24, 50704 Tartu telefon: 508 1671 telefaks: 730 2844 e-post: jyri@danteks.net http://www.danteks.net võõrkeeled: inglise, saksa, soome, vene
Elle MELLIK	AAA Patendibüroo OÜ Tartu mnt 16, 10117 Tallinn pk 3926, 10509 Tallinn telefon: 660 5910, 660 5911 telefaks: 660 5912 e-post: aaa@aaa.ee http://www.aaa.ee võõrkeeled: inglise, vene	Jaak OSTRAT	LASVET Patendibüroo OÜ Suurtüki 4a, 10133 Tallinn pk 3136, 10505 Tallinn telefon: 640 6600 telefaks: 640 6604 e-post: lasvet@lasvet.ee http://www.lasvet.ee võõrkeeled: inglise, saksa, soome, vene
Mikas MINIOTAS	AAA Patendibüroo OÜ Tartu mnt 16, 10117 Tallinn pk 3926, 10509 Tallinn telefon: 660 5910 telefaks: 660 5912 e-post: aaa@aaa.ee http://www.aaa.ee võõrkeeled: leedu, inglise, vene		

Villu PAVELTS	LASVET Patendibüroo OÜ Suurtüki 4a, 10133 Tallinn pk 3136, 10505 Tallinn telefon: 640 6600 telefaks: 640 6604 e-post: lasvet@lasvet.ee http://www.lasvet.ee võõrkeeled: inglise, soome, vene	Margus SARAP	Sarap ja Partnerid Patendibüroo Riia 185A, 51014 Tartu telefon: 747 7058 telefaks: 747 7059 e-post: patent@patent.ee http://www.patent.ee võõrkeeled: inglise, vene
Kaie PUUR	Patendibüroo RestMark OÜ WTC Tallinn Ahtri 8, 10151 Tallinn Patendibüroo RestMark OÜ Kompanii 1c, 51004 Tartu telefon: 655 9803 telefaks: 747 7059 e-post: kaie.puur@restmark.ee http://www.restmark.ee võõrkeeled: inglise, vene, saksa	Almar SEHVER	AAA Patendibüroo OÜ Tartu mnt 16, 10117 Tallinn pk 3926, 10509 Tallinn telefon: 660 5910, 660 5911 telefaks: 660 5912 e-post: aaa@aaa.ee http://www.aaa.ee võõrkeeled: inglise, vene
Linnar PUUSEPP	LASVET Patendibüroo OÜ Suurtüki 4a, 10133 Tallinn pk 3136, 10505 Tallinn telefon: 640 6600 telefaks: 640 6604 e-post: lasvet@lasvet.ee http://www.lasvet.ee võõrkeeled: inglise, vene	Harald TEHVER	Patendibüroo TURVAJA OÜ Liivalaia 22, 10118 Tallinn telefon: 640 3109 telefaks: 640 3105 e-post: turvaja@turvaja.ee http://www.turvaja.ee võõrkeeled: inglise, saksa, vene
Riina PÄRN	INTELS Patendibüroo OÜ Magasini 12, 51005 Tartu telefon: 742 0401 telefaks: 742 0326 e-post: intels@intels.ee http://www.intels.ee võõrkeeled: inglise, vene	Kadri TOOMSALU	kutsetegevus on peatatud
Tarmo ROSMAN	Rosman ja Partnerid OÜ pk 652, 12602 Tallinn telefon: 656 1450 telefaks: 656 1450 e-post: tarman@cc.ttu.ee võõrkeeled: saksa, inglise, ungari, vene	Olga TREUFELDT	Patendibüroo TURVAJA OÜ Liivalaia 22 10118 Tallinn telefon: 640 3109 telefaks: 640 3105 e-post: turvaja@turvaja.ee http://www.turvaja.ee võõrkeeled: inglise, vene
Arvo SALUMÄE	OÜ Amende Patendibüroo J. Köleri 8, 10150 Tallinn telefon: 648 6125 telefaks: 641 0174 e-post: amende@hot.ee võõrkeeled: inglise, saksa, soome, vene	Enn URGAS	Patendibüroo TURVAJA OÜ Liivalaia 22, 10118 Tallinn telefon: 640 3109 telefaks: 640 3105 e-post: turvaja@turvaja.ee http://www.turvaja.ee võõrkeeled: inglise, vene
		Juta-Maris UUSTALU	OÜ Amende Patendibüroo J. Köleri 8, 10150 Tallinn telefon: 648 6125 telefaks: 641 0174 e-post: amende@hot.ee võõrkeeled: inglise, vene

**LIST OF PATENT ATTORNEYS, REGISTERED IN
THE ESTONIAN STATE REGISTER OF PATENT ATTORNEYS
(by 29 October 2013)**

Register is established on September 1st 2001

FIELD OF ACTIVITY: TRADEMARKS, INDUSTRIAL DESIGNS AND GEOGRAPHICAL INDICATIONS

Arno ANIJALG	Patendibüroo Ustervall OÜ Kivi 21-6 51009 Tartu, Estonia Phone: +372 744 1980 Fax: +372 744 1785 E-mail: anijalg@ustervall.ee Http://www.ustervall.ee German, Russian, Estonian	Juhan HÄMMALOV	INTELS Patent and Trademark Agency Magasini 12 51005 Tartu, Estonia Phone: +372 742 0401 Fax: +372 742 0326 E-mail: intels@intels.ee Http://www.intels.ee English, German, Russian, Estonian
Aivo ARULA	Patent Agency Käosaar & Co Tähe Str. 94 50107 Tartu, Estonia Phone: +372 738 3051 Fax: +372 738 3055 E-mail: info@kaosaar.ee Http://www.kaosaar.ee English, Russian, Estonian	Martin JÕGI	Lasvet Ltd. P.O. Box 3136 10505 Tallinn, Estonia Phone: +372 640 6600 Fax: +372 640 6604 E-mail: lasvet@lasvet.ee Http://www.lasvet.ee Finnish, Russian, English, Estonian
Martina BÖCKLER-LORVI	Lasvet Ltd. P.O. Box 3136 10505 Tallinn, Estonia Phone: +372 640 6600 Fax: +372 640 6604 E-mail: lasvet@lasvet.ee Http://www.lasvet.ee English, Finnish, Estonian	Uno JÄÄGER	Inseneribüroo Uneko Ltd. Rüütli 51a 80010 Pärnu, Estonia Phone: +372 447 1021 Fax: +372 447 1001 GSM: +372 515 1844 E-mail: info@uneko.ee Http://www.uneko.ee English, Finnish, Russian, Estonian
Indrek EELMETS	law firm SORAINEN Pärnu Road 15 10141 Tallinn, Estonia Phone: +372 640 0900 Fax: +372 640 0901 E-mail: estonia@sorainen.com Http://www.sorainen.com English, Russian, Finnish, Estonian	Sirje KAHU	Patendibüroo Ustervall OÜ Kivi 21-6 51009 Tartu, Estonia Phone: +372 744 1980 Fax: +372 744 1785 E-mail: skahu@ustervall.ee Http://www.ustervall.ee English, Russian, Estonian
Alla HÄMMALOV	INTELS Patent and Trademark Agency Magasini 12 51005 Tartu, Estonia Phone: +372 742 0401 Fax: +372 742 0326 E-mail: intels@intels.ee Http://www.intels.ee English, Polish, Russian, Estonian	Lembit KALEV	Patent Bureau ROOSILLA Ltd. Järveotsa Road 39-61 13520 Tallinn, Estonia Phone: +372 657 1722 +372 657 5381 Fax: +372 657 5381 GSM: +372 511 9951 E-mail: roosilla@roosilla.ee Http://www.roosilla.ee English, Russian, Estonian

- Anneli KANG** **Synest Ltd.**
P.O. Box 977
13402 Tallinn, Estonia
Phone: +372 660 9786
Fax: +372 660 9787
E-mail: anneli@synest.ee
English, German, Russian,
French, Finnish, Swedish,
Estonian
- Anneli KAPP** **Patent Agency Käosaar & Co**
Tähe Str. 94
50107 Tartu, Estonia
Phone: +372 738 3051
Fax: +372 738 3055
E-mail: info@kaosaar.ee
Http://www.kaosaar.ee
English, Russian, Estonian
- Urmas KAULER** **Patendibüroo TURVAJA OÜ**
Liivalaia 22
10118 Tallinn, Estonia
Phone: +372 640 3109
Fax: +372 640 3105
E-mail: turvaja@turvaja.ee
Http://www.turvaja.ee
English, Russian, Finnish,
Estonian
- Urmas KERNU** **AAA Legal Services**
Tartu Road 16
10117 Tallinn, Estonia
P.O. Box 3926
10509 Tallinn, Estonia
Phone: +372 660 5910
+372 660 5911
Fax: +372 660 5912
E-mail: aaa@aaa.ee
Http://www.aaa.ee
English, German, Finnish,
Russian, Estonian
- Ljubov KESSELMAN** **Kesna Ltd.**
Tedre Str. 77-52
10616 Tallinn, Estonia
Phone: +372 660 8068
Fax: +372 660 8069
E-mail: kesna@kesna.ee
Http://www.kesna.ee
English, Russian, Estonian
- Marina KESSELMAN** **Kesna Ltd.**
Tedre Str. 77-52
10616 Tallinn, Estonia
Phone: +372 660 8068
Fax: +372 660 8069
E-mail: kesna@kesna.ee
Http://www.kesna.ee
English, German, Russian,
Estonian
- Raivo KOITEL** **Patent & Trademark Agency
Koitel**
Tartu Road 65
10115 Tallinn, Estonia
P.O. Box 1759
10902 Tallinn, Estonia
Phone: +372 603 3260
Fax: +372 603 3261
E-mail: koitel@koitel.ee
Http://www.koitel.ee
English, Finnish, Russian,
Estonian
- Katrin
KOITEL-VEIDIK** **Patent & Trademark Agency
Koitel**
Tartu Road 65
10115 Tallinn, Estonia
P.O. Box 1759
10902 Tallinn, Estonia
Phone: +372 603 3260
Fax: +372 603 3261
E-mail: koitel@koitel.ee
Http://www.koitel.ee
English, Finnish, Estonian
- Mart Enn KOPPEL** **KOPPEL patendibüroo OÜ**
Roseni 10-151
10111 Tallinn, Estonia
Phone: +372 677 4136
Fax: +372 677 4138
E-mail: info@koppelpb.com
Http://www.koppelpb.com
English, Russian, Finnish,
Estonian
- Anna KOSAR** **Patent & Trademark Agency
Koitel**
Tartu Road 65
10115 Tallinn, Estonia
P.O. Box 1759
10902 Tallinn, Estonia
Phone: +372 603 3260
Fax: +372 603 3261
E-mail: koitel@koitel.ee
Http://www.koitel.ee
English, Russian, Estonian
- Heinrich KRUPP** **Patendibüroo TURVAJA OÜ**
Liivalaia 22
10118 Tallinn, Estonia
Phone: +372 640 3109
Fax: +372 640 3105
E-mail: turvaja@turvaja.ee
Http://www.turvaja.ee
German, Russian, Estonian

Jüri KÄOSAAR	Patent Agency Käosaar & Co Tähe Str. 94 50107 Tartu, Estonia Phone: +372 738 3051 Fax: +372 738 3055 E-mail: info@kaosaar.ee Http://www.kaosaar.ee English, Russian, Estonian	Elle MELLIK	AAA Legal Services Tartu Road 16 10117 Tallinn, Estonia P.O. Box 3926 10509 Tallinn, Estonia Phone: +372 660 5910 +372 660 5911 Fax: +372 660 5912 E-mail: aaa@aaa.ee Http://www.aaa.ee English, Russian, Estonian
Kalev KÄOSAAR	Patent Agency Käosaar & Co Suur-Patarei 2 10415 Tallinn, Estonia Phone: +372 637 9484 Fax: +372 637 9485 E-mail: kalev.kaosaar@kaosaar.ee Http://www.kaosaar.ee English, Russian, Estonian	Mikas MINIOTAS	AAA Legal Services Tartu Road 16 10117 Tallinn, Estonia P.O. Box 3926 10509 Tallinn, Estonia Phone: +372 660 5910 Fax: +372 660 5912 E-mail: aaa@aaa.ee Http://www.aaa.ee Lithuanian, English, Russian, Estonian
Kärt LAIGU	professional activities have been suspended		
Kristjan LEPPIK	Patendibüroo TURVAJA OÜ Liivalaia 22 10118 Tallinn, Estonia Phone: +372 640 3109 Fax: +372 640 3105 E-mail: turvaja@turvaja.ee Http://www.turvaja.ee English, Russian, Estonian	Lembit MITT	AAA Legal Services Tartu Road 16 10117 Tallinn, Estonia P.O. Box 3926 10509 Tallinn, Estonia Phone: +372 660 5910 +372 660 5911 Fax: +372 660 5912 E-mail: aaa@aaa.ee Http://www.aaa.ee English, Russian, Estonian
Reet MAASIKAMÄE	Patent Bureau Kaitsepurus Mulla Str. 4-3 10611 Tallinn, Estonia Phone: +372 673 9097 +372 566 75197 Fax: +372 677 4844 E-mail: purus@kaitsepurus.ee Http://www.kaitsepurus.ee English, Russian, Estonian	Ott MOORLAT	Moorlat & Co Ltd. Patent Bureau P.O. Box 4730 13503 Tallinn, Estonia Phone: +372 648 2085 Fax: +372 654 2844 E-mail: ott.moorlat@moorlat.ee Http://www.moorlat.ee English, Russian, Estonian
Ingrid MATSINA	AAA Legal Services Tartu Road 16 10117 Tallinn, Estonia P.O. Box 3926 10509 Tallinn, Estonia Phone: +372 660 5910 +372 660 5911 Fax: +372 660 5912 E-mail: aaa@aaa.ee Http://www.aaa.ee English, Russian, German, French, Estonian	Anfia MORNA	Patendibüroo TURVAJA OÜ Liivalaia 22 10118 Tallinn, Estonia Phone: +372 640 3109 Fax: +372 640 3105 E-mail: turvaja@turvaja.ee Http://www.turvaja.ee English, Russian, Estonian
Raivo MATSOO	RM Hirvela Patent Bureau Ltd Endla 3, 10122 Tallinn, Estonia Phone: +372 614 0816 Fax: +372 614 0818 E-mail: hirvela@hirvela.ee English, Russian, Estonian	Mari MUST	Raidla Lejins & Norcous Advokaadibüroo OÜ Roosikrantsi 2 10119 Tallinn, Estonia Phone: +372 640 7170 Fax: +372 640 7171 E-mail: mari.must@rln.ee Http://www.rln.ee English, Finnish, Estonian

- Tõnu NELAS** **AAA Legal Services**
Tartu Road 16
10117 Tallinn, Estonia
P.O. Box 3926
10509 Tallinn, Estonia
Phone: +372 660 5910
 +372 660 5911
Fax: +372 660 5912
E-mail: aaa@aaa.ee
Http://www.aaa.ee
English, Russian, Finnish,
Estonian
- Jüri OLT** **Danteks OÜ**
Kalda tee 24
50704 Tartu, Estonia
Phone: +372 508 1671
Fax: +372 730 2844
E-mail: jyri@danteks.net
Http://www.danteks.net
English, German, Finnish,
Russian, Estonian
- Jaak OSTRAT** **Lasvet Ltd.**
P.O. Box 3136
10505 Tallinn, Estonia
Phone: +372 640 6600
Fax: +372 640 6604
E-mail: lasvet@lasvet.ee
Http://www.lasvet.ee
English, German, Finnish,
Russian, Estonian
- Villu PAVELTS** **Lasvet Ltd.**
P.O. Box 3136
10505 Tallinn, Estonia
Phone: +372 640 6600
Fax: +372 640 6604
E-mail: lasvet@lasvet.ee
Http://www.lasvet.ee
English, Finnish, Russian,
Estonian
- Kaie PUUR** **Patendibüroo RestMark OÜ**
WTC Tallinn
Ahtri 8
10151 Tallinn, Estonia
Patendibüroo RestMark OÜ
Kompanii 1c
51004 Tartu, Estonia
Phone: +372 655 9803
Fax: +372 747 7059
E-mail: kaie.puur@restmark.ee
Http://www.restmark.ee
English, Russian, German,
Estonian
- Linnar PUUSEPP**
- Riina PÄRN**
- Tarmo ROSMAN**
- Arvo SALUMÄE**
- Margus SARAP**
- Almar SEHVER**
- Lasvet Ltd.**
P.O. Box 3136
10505 Tallinn, Estonia
Phone: +372 640 6600
Fax: +372 640 6604
E-mail: lasvet@lasvet.ee
Http://www.lasvet.ee
English, Russian, Estonian
- INTELS Patent and Trademark Agency**
Magasini 12
51005 Tartu, Estonia
Phone: +372 742 0401
Fax: +372 742 0326
E-mail: intels@intels.ee
Http://www.intels.ee
English, Russian, Estonian
- Rosman and Partners Ltd.**
P.O. Box 652
12602 Tallinn, Estonia
Phone: +372 656 1450
Fax: +372 656 1450
E-mail: tarman@cc.ttu.ee
German, English, Hungarian,
Russian, Estonian
- AMENDE Patent Agency Ltd.**
J. Köleri 8, 10150 Tallinn,
Estonia
Phone: +372 648 6125
Fax: +372 641 0174
E-mail: amende@hot.ee
English, German, Finnish,
Russian, Estonian
- Sarap ja Partnerid Patendibüroo**
Riia 185A
51014 Tartu, Estonia
Phone: +372 747 7058
Fax: +372 747 7059
E-mail: patent@patent.ee
Http://www.patent.ee
English, Russian, Estonian
- AAA Legal Services**
Tartu Road 16
10117 Tallinn, Estonia
P.O. Box 3926
10509 Tallinn, Estonia
Phone: +372 660 5910
 +372 660 5911
Fax: +372 660 5912
E-mail: aaa@aaa.ee
Http://www.aaa.ee
English, Russian, Estonian

Harald TEHVER**Patendibüroo TURVAJA OÜ**

Liivalaia 22
10118 Tallinn, Estonia
Phone: +372 640 3109
Fax: +372 640 3105
E-mail: turvaja@turvaja.ee
Http://www.turvaja.ee
English, German, Russian,
Estonian

Enn URGAS**Patendibüroo TURVAJA OÜ**

Liivalaia 22
10118 Tallinn, Estonia
Phone: +372 640 3109
Fax: +372 640 3105
E-mail: turvaja@turvaja.ee
Http://www.turvaja.ee
English, Russian, Estonian

Kadri TOOMSALU

professional activities have been
suspended

Juta-Maris UUSTALU**AMENDE Patent Agency
Ltd.**

J. Köleri 8, 10150 Tallinn,
Estonia
Phone: +372 648 6125
Fax: +372 641 0174
E-mail: amende@hot.ee
English, Russian, Estonian

Olga TREUFELDT**Patendibüroo TURVAJA OÜ**

Liivalaia 22
10118 Tallinn, Estonia
Phone: +372 640 3109
Fax: +372 640 3105
E-mail: turvaja@turvaja.ee
Http://www.turvaja.ee
English, Russian, Estonian