

EESTI VABARIIK

ISSN 1406-376X (trükkis)  
ISSN 2228-3617 (võrguväljaanne)

# T EESTI TÖÖSTUSDISAINI- LAHENDUSE LEHT



PATENDIAMETI AMETLIK VÄLJAANNE

3  
2013  
TALLINN

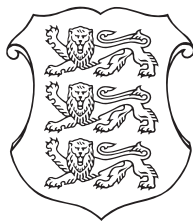

EESTI VABARIIK

ISSN 1406-376X (trükiis)  
ISSN 2228-3617 (võrguväljaanne)

**T**

**T** **EESTI**  
**TÖÖSTUSDISAINI-**  
**LAHENDUSE LEHT**

**PATENDIAMETI  
AMETLIK VÄLJAANNE**

**XVI aastakäik**

**Käesolevas numbris  
esitatud andmed  
loetakse avaldatuks  
15. augustil 2013. a.**

**3**  
**2013**  
**AUGUST  
TALLINN**

Eesti Tööstusdisainilahenduse Lehte antakse välja tööstusdisaini kaitse seaduse paragrahvi 55 lõike 3 alusel.

The Estonian Industrial Design Gazette is the official publication of the Estonian Patent Office published under § 33(3) of the Industrial Design Protection Act of the Republic of Estonia.

The data presented in this issue is deemed to be published on 15 August 2013.

Patendiameti  
infoosakond  
Toompuiestee 7  
15041 Tallinn  
Tel 627 7907  
Faks 627 7943  
E-post Info@epa.ee

The Information Department  
of the Estonian Patent Office  
Toompuiestee 7  
15041 Tallinn, ESTONIA  
Phone +372 627 7907  
Fax+372 627 7943  
E-mail Info@epa.ee

Levitaja

Eesti Intellektuaalomandi ja  
Tehnoloogiasirde Keskus  
Teaduspargi 8  
12618 Tallinn  
Tel 641 1250  
E-post patent@patentinfo.ee

Distributor

Estonian Intellectual Property and Technology  
Transfer Centre  
Teaduspargi 8  
12618 Tallinn, ESTONIA  
Phone +372 641 1250  
E-mail patent@patentinfo.ee

**SISUKORD**

Andmete identifitseerimise rahvusvahelised numberkoodid (INID-koodid) . . . . .	4
Riikide, teiste ühenduste ja valitsustevaheliste organisatsioonide koodid . . . . .	5
I. REGISTREERITUD TÖÖSTUSDISAINILAHENDUSED . . . . .	6
II. RAHVUSVAHELISELT REGISTREERITUD TÖÖSTUSDISAINILAHENDUSED . . . . .	22
III. MUUD REGISTRIKANDED . . . . .	35
Registreeringu kehtivuse pikendamine . . . . .	35
Tööstusdisainilahenduse üleminek . . . . .	-
Registreeringu jagamine . . . . .	-
Registreeringu andmete muudatused . . . . .	35
Registreeringu andmete parandused . . . . .	-
Tööstusdisainilahenduse litsentsimine . . . . .	35
Tööstusdisainilahenduse pantimine . . . . .	-
Tööstusdisainilahenduse tunnistuse duplikaadi väljaandmine . . . . .	-
Registreeringu kustutamine . . . . .	35
IV. LOENDID . . . . .	36
Registreeritud tööstusdisainilahenduste registreerimise taotluste numbriline loend . . . . .	36
Rahvusvaheliselt registreeritud tööstusdisainilahenduste numbriline loend . . . . .	36
V. TÖÖSTUSDISAINIALASED ÕIGUSAKTID JA MUU INFO . . . . .	37
Riiklikus patendivolinike registris registreeritud patendivolinike nimekiri . . . . .	37

**CONTENTS**

Internationally Agreed Numbers for the Identification of Data (INID Codes) . . . . .	4
List of Codes of States, Other Entities and Intergovernmental Organizations . . . . .	5
I. REGISTERED INDUSTRIAL DESIGNS . . . . .	6
II. INTERNATIONALLY REGISTERED INDUSTRIAL DESIGNS . . . . .	22
III. OTHER ENTRIES IN THE REGISTER . . . . .	35
Extension of the Registration . . . . .	35
Transfer of Industrial Design . . . . .	-
Division of the Registration. . . . .	-
Amendments to Registration Data . . . . .	35
Corrections to Registration Data . . . . .	-
Licensing of Industrial Design . . . . .	35
Pledging of Industrial Design . . . . .	-
Issue of a Copy of the Industrial Design Certificate . . . . .	-
Deletion of the Registration . . . . .	35
IV. LISTS . . . . .	36
Numerical List of Registration Applications of Registered Industrial Designs . . . . .	36
Numerical List of Internationally Registered Industrial Designs . . . . .	36
V. LEGAL ACTS AND INFORMATION CONCERNING INDUSTRIAL DESIGNS . . . . .	37
List of Patent Attorneys, Registered in the Estonian State Register of Patent Attorneys . . . . .	41

**ANDMETE IDENTIFITSEERIMISE  
RAHVUSVAHELISED NUMBERKOODID  
(INID-KOODID)  
WIPO Standard ST. 80**

**INTERNATIONALLY AGREED NUMBERS FOR  
THE IDENTIFICATION OF DATA  
(INID CODES)  
WIPO Standard ST. 80**

(11) Registreeringu number	(11) Number of the Registration
(15) Registreerimise kuupäev	(15) Date of the Registration
(18) Registreeringu kehtivuse lõppemise kuupäev	(18) Expected expiration date of the registration
(21) Registreerimistaotluse number	(21) Application Number
(22) Registreerimistaotluse esitamise kuupäev	(22) Application Filing Date
(24) Registreeringu kehtivuse alguse kuupäev	(24) Date from which the Industrial Design right has effected
(28) Variantide arv	(28) Number of Industrial Designs included in the application
(30) Prioriteet	(30) Priority
(51) Rahvusvahelise klassifikatsiooni klassi ja alaklassi number	(51) International Classification for Industrial Designs (class and subclass of the Locarno Classification)
(54) Tööstusdisainilahenduse nimetus	(54) Title of the Industrial Design
(55) Tööstusdisainilahenduse reproduktsioon	(55) Reproduction of the Industrial Design
(72) Tööstusdisainilahenduse autor(id)	(72) Author(s) of Industrial Design
(73) Tööstusdisainilahenduse omanik(ud)	(73) Proprietor(s) of Industrial Design
(74) Patendivolinik või ühine esindaja	(74) Patent Attorney or Common Representative

**RIIKIDE, TEISTE ÜHENDUSTE JA VALITSUSTEVAAHELISTE  
ORGANISATSIOONIDE KOODID**  
WIPO Standard ST. 3

AD	Andorra	EA	Euraasia Patendiorgani-	KH	Kambodža	RS	Serbia
AE	Araabia		satsioon (EAPO)	KI	Kiribati	RU	Venemaa
	Ühendemiraadid	EC	Ecuador	KM	Komoorid	RW	Rwanda
AF	Afganistan	EE	Eesti	KN	Saint Kitts ja Nevis	SA	Saudi Araabia
AG	Antigua ja Barbuda	EG	Egiptus	KP	Põhja-Korea	SB	Saalomoni Saared
AI	Anguilla	EH	Lääne-Sahara	KR	Lõuna-Korea	SC	Seišellid
AL	Albaania	EM	Siseturu Ühtlustamise	KW	Kuveit	SD	Sudaan
AM	Armeenia		Amet (kaubamärgid ja	KY	Kaimanisaared	SE	Rootsi
AO	Angola		tööstusdisainilahen-	KZ	Kasahstan	SG	Singapur
AP	Aafrika Regionaalne		dused) (OHIM)	LA	Laos	SH	Saint Helena, Ascension
	Tööstusomandi Orga-	EP	Euroopa	LB	Liibanon		ja Tristan da Cunha
	nisatsioon (ARIPO)		Patendiamet (EPO)	LC	Saint Lucia	SI	Sloveenia
AR	Argentina	ER	Eritrea	LI	Liechtenstein	SK	Slovakkia
AT	Austria	ES	Hispaania	LK	Sri Lanka	SL	Sierra Leone
AU	Austraalia	ET	Etiopia	LR	Libeeria	SM	San Marino
AW	Aruba	FI	Soome	LS	Lesotho	SN	Senegal
AZ	Aserbaidžaan	FJ	Fidži	LT	Leedu	SO	Somaalia
BA	Bosnia ja Hertsegoviina	FK	Falklandi (Malviini)	LU	Luksemburg	SR	Suriname
BB	Barbados		saared	LV	Läti	SS	Lõuna-Sudaan
BD	Bangladesh	FO	Fääri saared	LY	Liibüa	ST	São Tomé ja Príncipe
BE	Belgia	FR	Prantsusmaa	MA	Maroko	SV	El Salvador
BF	Burkina Faso	GA	Gabon	MC	Monaco	SX	Sint Maarten (Hollandi
BG	Bulgaaria	GB	Ühendkuningriik	MD	Moldova		osa)
BH	Bahrein		(Suurbritannia)	ME	Montenegro	SY	Süüria
BI	Burundi	GC	Pärsia Lahe	MG	Madagaskar	SZ	Svaasimaa
BJ	Benin		Koostöönõukogu	MK	Makedoonia	TC	Turks ja Caicos
BM	Bermuda	GD	Grenada	ML	Mali	TD	Tšaad
BN	Brunei	GE	Gruusia	MM	Myanmar (Birma)	TG	Togo
BO	Boliivia	GG	Guernsey	MN	Mongoolia	TH	Tai
BQ	Bonaire, Sint	GH	Ghana	MO	Macao	TJ	Tadžikistan
	Eustatius ja Saba	GI	Gibraltari	MP	Põhja-Mariaanid	TL	Ida-Timor
BR	Brasiilia	GL	Gröönimaa	MR	Mauritaania	TM	Türkmenistan
BS	Bahama	GM	Gambia	MS	Montserrat	TN	Tuneesia
BT	Bhutan	GN	Guinea	MT	Malta	TO	Tonga
BV	Bouvet' saar	GQ	Ekvatoriaal-Guinea	MU	Mauritius	TR	Türgi
BW	Botswana	GR	Kreeka	MV	Maldiivid	TT	Trinidad ja Tobago
BX	Beneluxi Kaubamärgi-	GS	Lõuna-Georgia ja	MW	Malawi	TV	Tuvalu
	amet (BBM) ja Beneluxi		Lõuna-Sandwichi	MX	Mehhiko	TW	Taiwan (Hiina provints)
	Tööstusdisainilahendus-		saared	MY	Malaisia	TZ	Tansaania
	te Amet (BBDM)	GT	Guatemala	MZ	Mosambiik	UA	Ukraina
BY	Valgevene	GW	Guinea-Bissau	NA	Namiibia	UG	Uganda
BZ	Belize	GY	Guyana	NE	Niger	US	Ameerika
CA	Kanada	HK	Hongkong	NG	Nigeeria		Ühendriigid
CD	Kongo Demokraatlik	HN	Honduras	NI	Nicaragua	UY	Uruguay
	Vabariik	HR	Horvaatia	NL	Holland	UZ	Usbekistan
CF	Kesk-Aafrika Vabariik	HT	Haiti	NO	Norra	VA	Vatikan (Püha Tool)
CG	Kongo	HU	Ungari	NP	Nepal	VC	Saint Vincent ja
CH	Šveits	IB	Maailma	NR	Nauru		Grenadiinid
CI	Côte d'Ivoire		Intellektuaalomandi	NZ	Uus-Meremaa	VE	Venezuela
CK	Cooki saared		Organisatsiooni (WIPO)	OA	Aafrika Intellektuaal-	VG	Neitsisaared
CL	Tšiili		Rahvusvaheline Büroo		omandi Organisatsioon	VN	Vietnam
CM	Kamerun	ID	Indoneesia		(OAPI)	VU	Vanuatu
CN	Hiina	IE	Iiri	OM	Omaan	WO	Maailma
CO	Kolumbia	IL	Iisrael	PA	Panama		Intellektuaalomandi
CR	Costa Rica	IM	Man'i saar	PE	Peruu		Organisatsioon (WIPO)
CU	Kuuba	IN	India	PG	Paapua Uus-Guinea		(Rahvusvaheline Büroo)
CV	Cabo Verde	IQ	Iraak	PH	Filipiinid	WS	Samoa
CW	Curaçao	IR	Iraan	PK	Pakistan	XN	Põhjamaade
CY	Küpros	IS	Island	PL	Poola		Patendiinstituut (PPI)
CZ	Tšehhi	IT	Itaalia	PT	Portugal	YE	Jeemen
DE	Saksamaa	JE	Jersey	PW	Belau	ZA	Lõuna-Aafrika Vabariik
DJ	Djibouti	JM	Jamaica	PY	Paraguay	ZM	Sambia
DK	Taani	JO	Jordaania	QA	Katar	ZW	Zimbabwe
DM	Dominica	JP	Jaapan	QZ	Ühenduse Sordiamet		
DO	Dominikaani Vabariik	KE	Kenya		(Euroopa Liit) (EÜSA)		
DZ	Alžeeria	KG	Kõrgõzstan	RO	Rumeenia		

## **I. REGISTREERITUD TÖÖSTUSDISAINILAHENDUSED**

Avaldatakse "Tööstusdisaini kaitse seaduse" § 55<sup>1</sup> lõike 7 alusel.

Patendiamet ei ole kontrollinud tööstusdisainilahenduse uudsust ja eristatavust tulenevalt "Tööstusdisaini kaitse seaduse" § 31 lõike 2 punktist 1.

(11) **Registreeringu number** **01813**

(51) Klass: **28-99**

(21) **Taotluse number** D201300018

(15) **Registreerimise päev** 15.08.2013

(22) **Esitamise päev** 04.03.2013

(24) **Registreeringu kehtivuse alguse päev** 04.03.2013

(18) **Registreeringu kehtivuse lõppemise päev** 04.03.2018

(28) **Variantide arv** 1

(72) **Autor** Anna Tserkezova, Linnamäe tee 34-18, 13911 Tallinn, EE

(73) **Omanik** Anna Tserkezova, Linnamäe tee 34-18, 13911 Tallinn, EE

(54) **Nimetus** **Ripsmed**

(55) **Reproduktsoon**

01813-1

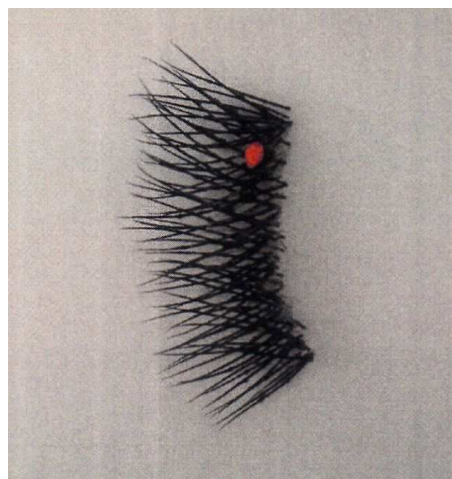
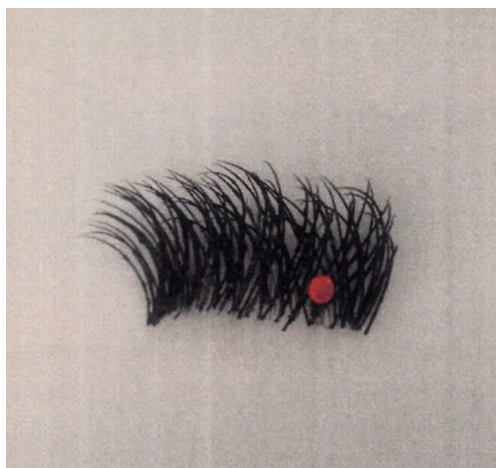



(11) **Registreeringu number** **01814**

(51) Klass: **30-06**

(21) **Taotluse number** D201300021

(15) **Registreerimise päev** 15.08.2013

(22) **Esitamise päev** 22.03.2013

(24) **Registreeringu kehtivuse  
alguse päev** 22.03.2013

(18) **Registreeringu kehtivuse  
lõppemise päev** 22.03.2018

(28) **Variantide arv** 1

(72) **Autor** Kadri Vokk, Sõpruse pst 220-5, 13416 Tallinn, EE

(73) **Omanik** Kadri Vokk, Sõpruse pst 220-5, 13416 Tallinn, EE

(54) **Nimetus** **Rippuv pesa**

(55) **Reproduktsoon**

01814-1

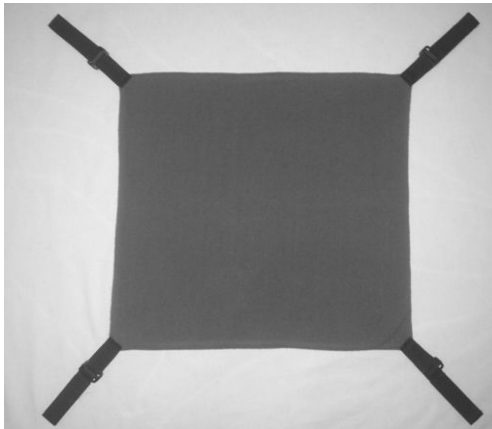

(11) Registreeringu number	<b>01815</b>	(51) Klass: <b>07-02</b>
(21) Taotluse number	D201300026	
(15) Registreerimise päev	15.08.2013	
(22) Esitamise päev	28.04.2013	
(24) Registreeringu kehtivuse alguse päev	28.04.2013	
(18) Registreeringu kehtivuse lõppemise päev	28.04.2018	
(28) Variantide arv	1	
(72) Autor	Üllar Hendla, Loobu, Kadrina, 45220 Lääne-Viru maakond, EE	
(73) Omanik	Üllar Hendla, Loobu, Kadrina, 45220 Lääne-Viru maakond, EE	

(54) Nimetus **Puidust toidualus**

(55) Reproduktsoon

01815-1

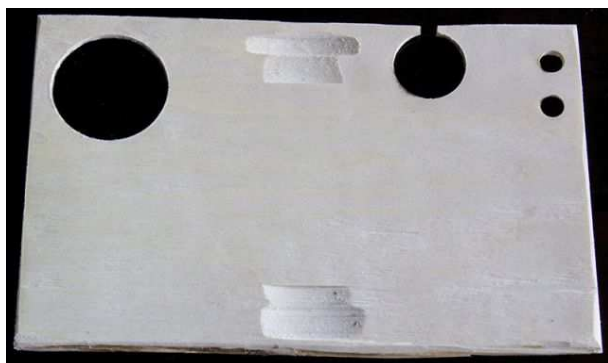

(11) Registreeringu number	<b>01816</b>	(51) Klass: <b>07-02</b>
(21) Taotluse number	D201300026A	
(15) Registreerimise päev	15.08.2013	
(22) Esitamise päev	28.04.2013	
(24) Registreeringu kehtivuse alguse päev	28.04.2013	
(18) Registreeringu kehtivuse lõppemise päev	28.04.2018	
(28) Variantide arv	1	
(72) Autor	Üllar Hendla, Loobu, Kadrina, 45220 Lääne-Viru maakond, EE	
(73) Omanik	Üllar Hendla, Loobu, Kadrina, 45220 Lääne-Viru maakond, EE	

(54) Nimetus **Puidust toidualus**

(55) Reproduktsoon

01816-1

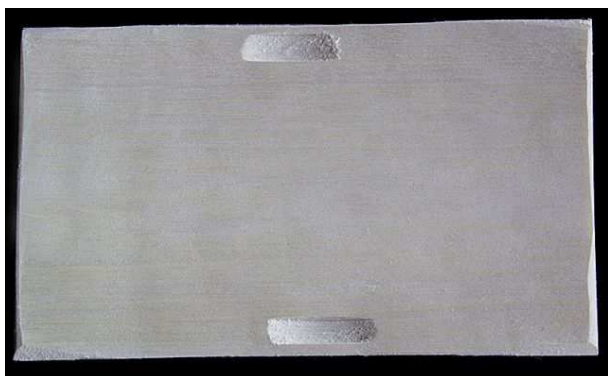

(11) Registreeringu number	<b>01817</b>
(21) Taotluse number	D201300027
(15) Registreerimise päev	15.08.2013
(22) Esitamise päev	02.05.2013
(24) Registreeringu kehtivuse alguse päev	02.05.2013
(18) Registreeringu kehtivuse lõppemise päev	02.05.2018
(28) Variantide arv	2
(72) Autor	Elena Koit, Astangu 21/1-22, 13519 Tallinn, EE
(73) Omanik	Elena Koit, Astangu 21/1-22, 13519 Tallinn, EE

(51) Klass: 10-02

(54) Nimetus **Käekell**

(55) Reproduktsoon

01817-1



01817-2



(11) Registreeringu number	<b>01818</b>	(51) Klass: <b>10-02</b>
(21) Taotluse number	D201300028	
(15) Registreerimise päev	15.08.2013	
(22) Esitamise päev	02.05.2013	
(24) Registreeringu kehtivuse alguse päev	02.05.2013	
(18) Registreeringu kehtivuse lõppemise päev	02.05.2018	
(28) Variantide arv	2	
(72) Autor	Elena Koit, Astangu 21/1-22, 13519 Tallinn, EE	
(73) Omanik	Elena Koit, Astangu 21/1-22, 13519 Tallinn, EE	

(54) Nimetus **Käekell**

(55) Reproduktsoon

01818-1



01818-2



(11) Registreeringu number	<b>01819</b>
(21) Taotluse number	D201300029
(15) Registreerimise päev	15.08.2013
(22) Esitamise päev	02.05.2013
(24) Registreeringu kehtivuse alguse päev	02.05.2013
(18) Registreeringu kehtivuse lõppemise päev	02.05.2018
(28) Variantide arv	2
(72) Autor	Elena Koit, Astangu 21/1-22, 13519 Tallinn, EE
(73) Omanik	Elena Koit, Astangu 21/1-22, 13519 Tallinn, EE

(51) Klass: **11-99**(54) Nimetus **Kaelahe**

(55) Reproduktsioon

01819-1



01819-2



- (11) **Registreeringu number** **01820** (51) Klass: **11-99**
- (21) **Taotluse number** D201300030
- (15) **Registreerimise päev** 15.08.2013
- (22) **Esitamise päev** 02.05.2013
- (24) **Registreeringu kehtivuse alguse päev** 02.05.2013
- (18) **Registreeringu kehtivuse lõppemise päev** 02.05.2018
- (28) **Variantide arv** 2
- (72) **Autor** Elena Koit, Astangu 21/1-22, 13519 Tallinn, EE
- (73) **Omanik** Elena Koit, Astangu 21/1-22, 13519 Tallinn, EE
- (54) **Nimetus** **Kaelahe**
- (55) **Reproduktsoon**

01820-1



01820-2



(11) **Registreeringu number** **01821**

(51) Klass: **06-01**

(21) **Taotluse number** D201300031

(15) **Registreerimise päev** 15.08.2013

(22) **Esitamise päev** 09.05.2013

(24) **Registreeringu kehtivuse alguse päev** 09.05.2013

(18) **Registreeringu kehtivuse lõppemise päev** 09.05.2018

(28) **Variantide arv** 3

(72) **Autor** Sven Sõrmus, Hariduse 11-11, 10119 Tallinn, EE

Martin Pärn, Ahju 5-19, 10118 Tallinn, EE

(73) **Omanik** Iseasi OÜ, Ahju 5-19, 10118 Tallinn, EE

(54) **Nimetus** **Pink**

(55) **Reproduktsoon**

01821-1

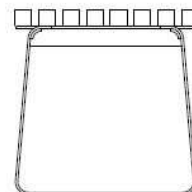

01821-2

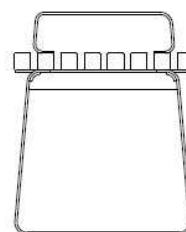
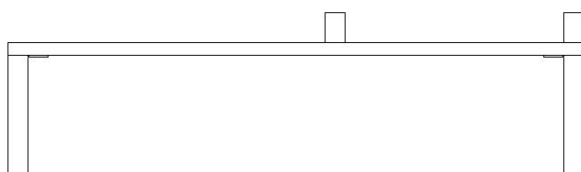



01821-3

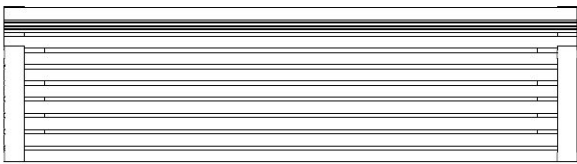
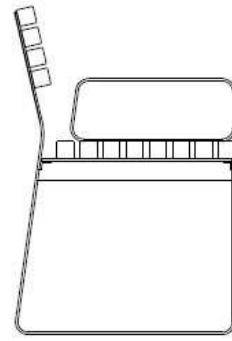
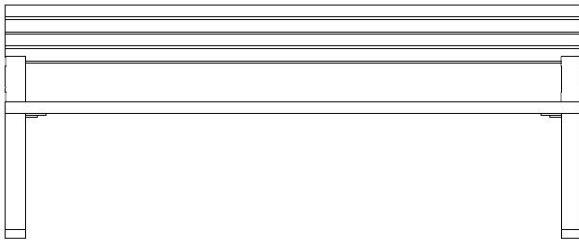

(11) Registreeringu number	<b>01822</b>	(51) Klass: <b>09-09</b>
(21) Taotluse number	D201300032	
(15) Registreerimise päev	15.08.2013	
(22) Esitamise päev	09.05.2013	
(24) Registreeringu kehtivuse alguse päev	09.05.2013	
(18) Registreeringu kehtivuse lõppemise päev	09.05.2018	
(28) Variantide arv	2	
(72) Autor	Sven Sõrmus, Hariduse 11-11, 10119 Tallinn, EE	
(73) Omanik	Iseasi OÜ, Ahju 5-19, 10118 Tallinn, EE	

(54) Nimetus **Prügikast**

(55) Reproduktsoon

01822-1

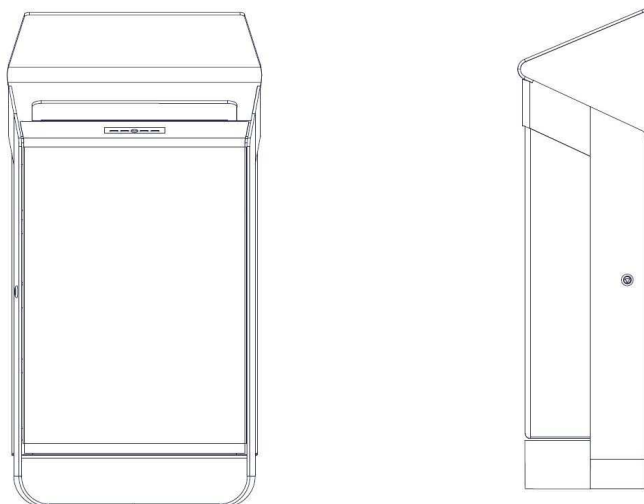

01822-2

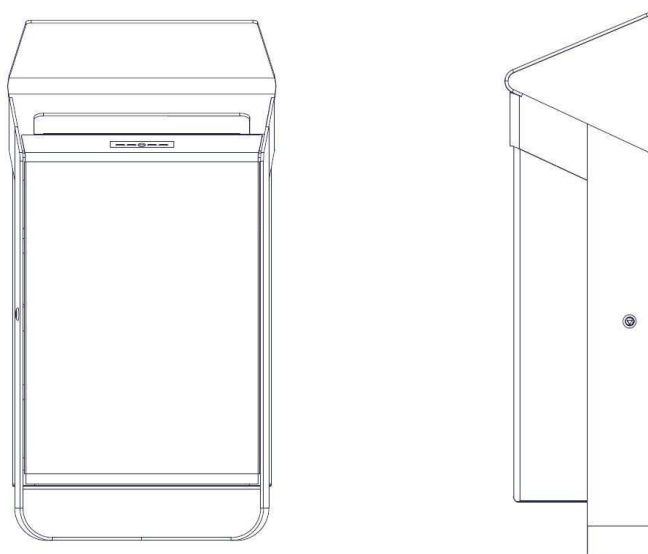

(11) **Registreeringu number** **01823**

(51) Klass: **25-03**

(21) **Taotluse number** D201300033

(15) **Registreerimise päev** 15.08.2013

(22) **Esitamise päev** 20.05.2013

(24) **Registreeringu kehtivuse  
alguse päev** 20.05.2013

(18) **Registreeringu kehtivuse  
lõppemise päev** 20.05.2018

(28) **Variantide arv** 1

(72) **Autor** *Autori andmeid ei avalikustata*

(73) **Omanik** Raul Uibopuu, Pärna 11, Otepää, 67404 Valga maakond, EE

(54) **Nimetus** **Freesprussidest kokkupandav saun**

(55) **Reproduktsoon**

01823-1

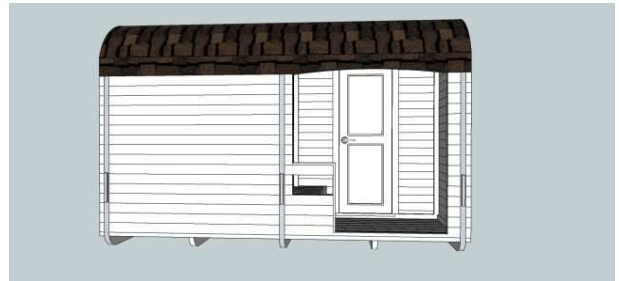

(11) Registreeringu number	<b>01824</b>
(21) Taotluse number	D201300034
(15) Registreerimise päev	15.08.2013
(22) Esitamise päev	31.05.2013
(24) Registreeringu kehtivuse alguse päev	31.05.2013
(18) Registreeringu kehtivuse lõppemise päev	31.05.2018
(28) Variantide arv	1
(72) Autor	Jüri Urb, Tartu mnt 65-25, 10115 Tallinn, EE
(73) Omanik	Jüri Urb, Tartu mnt 65-25, 10115 Tallinn, EE

(51) Klass: **11-99**

(54) Nimetus **Sõlg**

(55) Reproduktsoon

01824-1

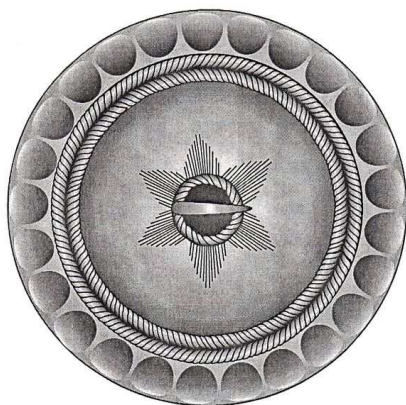

(11) **Registreeringu number** **01825**

(51) **Klass:** 11-02

(21) **Taotluse number** D201300035

(15) **Registreerimise päev** 15.08.2013

(22) **Esitamise päev** 26.06.2013

(24) **Registreeringu kehtivuse alguse päev** 26.06.2013

(18) **Registreeringu kehtivuse lõppemise päev** 26.06.2018

(28) **Variantide arv** 1

(72) **Autor** Tauno Kangro, Uus tn 20-1, 10111 Tallinn, EE

(73) **Omanik** Tauno Kangro, Uus tn 20-1, 10111 Tallinn, EE

(74) **Patendivolinik või ühine esindaja** Ott Moorlat

(54) **Nimetus** **Skulptuur**

(55) **Reproduktsoon**

01825-1



(11) Registreeringu number **01826**

(51) Klass: **11-02**

(21) Taotluse number D201300036

(15) Registreerimise päev 15.08.2013

(22) Esitamise päev 26.06.2013

(24) Registreeringu kehtivuse alguse päev 26.06.2013

(18) Registreeringu kehtivuse lõppemise päev 26.06.2018

(28) Variantide arv 1

(72) Autor Tauno Kangro, Uus tn 20-1, 10111 Tallinn, EE

(73) Omanik Tauno Kangro, Uus tn 20-1, 10111 Tallinn, EE

(74) Patendivolinik või ühine esindaja Ott Moorlat

(54) Nimetus **Skulptuur**

(55) Reproduktsoon

01826-1



## **II. RAHVUSVAHELISELT REGISTREERITUD TÖÖSTUSDISAINILAHENDUSED**

Avaldatakse "Tööstusdisaini kaitse seaduse" § 87<sup>4</sup> lõike 3 alusel.

Patendiamet ei ole kontrollinud tööstusdisainilahenduse uudsust ja eristatavust tulenevalt "Tööstusdisaini kaitse seaduse" § 31 lõike 2 punktist 1.

(11) **Rahvusvah reg nr**

**DM/079285**

(51) **Klass: 12-08**

(21) **Rahvusvah reg jrk**

H201200013

(15) **Registreeringu päev**

02.07.2012

(28) **Variantide arv**

2

(72) **Autor**

Antony Villain

(73) **Omanik**

Renault S.A.S., 13/15, quai Alphonse le Gallo,  
F-92100 Boulogne-Billancourt, FR

**WIPO Rahvusvah Tööstusdisainilahenduste  
Bülletääni nr, kus registreering on avaldatud**

42/2012

(55) **Reproduktsoon**

DM/079285-1

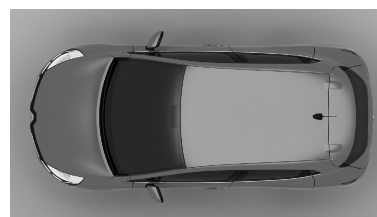



DM/079285-2

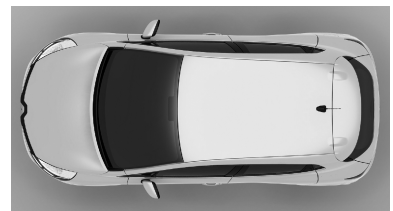

(11) **Rahvusvah reg nr**

**DM/079286**

(51) **Klass: 12-08**

(21) **Rahvusvah reg jrk**

H201200014

(15) **Registreeringu päev**

05.07.2012

(28) **Variantide arv**

1

(72) **Autor**

David Durand

(73) **Omanik**

Renault S.A.S., 13/15, quai Alphonse le Gallo,  
F-92100 Boulogne-Billancourt, FR

**WIPO Rahvusvah Tööstusdisainilahenduste**

**Bülletääni nr, kus registreering on avaldatud** 2012/42

(55) **Reproduksioon**

DM/079286-1

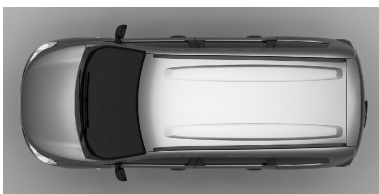

(11) **Rahvusvah reg nr**

**DM/079288**

(51) Klass: **26-06**

(21) **Rahvusvah reg jrk**

H201200015

(15) **Registreeringu päev**

02.07.2012

(28) **Variantide arv**

2

(72) **Autor**

Antony Villain

(73) **Omanik**

Renault S.A.S., 13/15, quai Alphonse le Gallo,  
F-92100 Boulogne-Billancourt, FR

**WIPO Rahvusvah Tööstusdisainilahenduste  
Bülletääni nr, kus registreering on avaldatud**

42/2012

(55) **Reproduksioon**

DM/079288-1

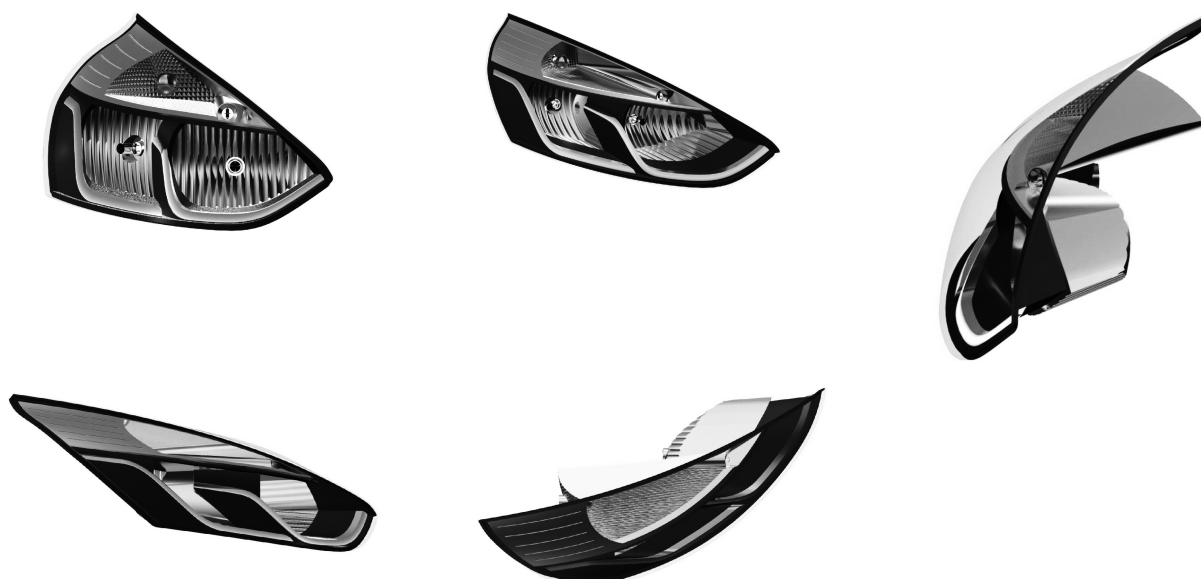

DM/079288-2



(11) **Rahvusvah reg nr**

**DM/079289**

(51) Klass: **26-06**

(21) **Rahvusvah reg jrk**

H201200016

(15) **Registreeringu päev**

05.07.2012

(28) **Variantide arv**

2

(72) **Autor**

David Durand

(73) **Omanik**

Renault S.A.S., 13/15, quai Alphonse le Gallo,  
F-92100 Boulogne-Billancourt, FR

**WIPO Rahvusvah Tööstusdisainilahenduste**

**Bülletääni nr, kus registreering on avaldatud** 2012/42

(55) **Reproduktsoon**

DM/079289-1

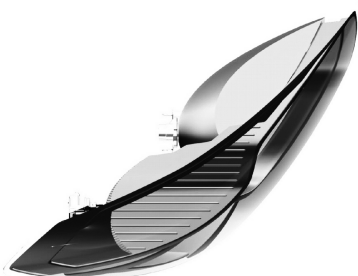
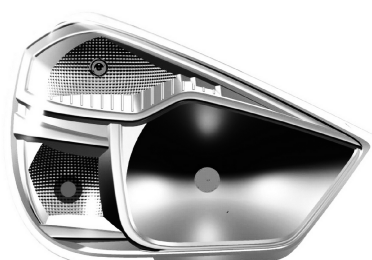

DM/079289-2

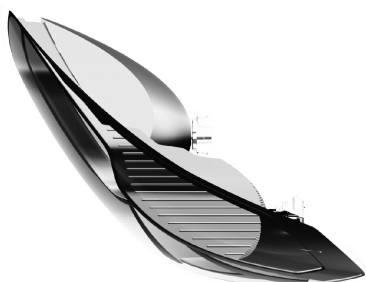
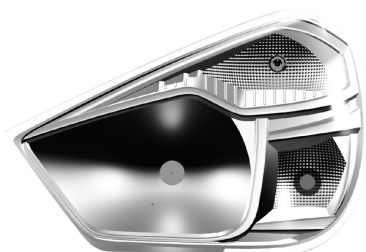

(11) **Rahvusvah reg nr**

**DM/079925**

(51) Klass: **13-03**

(21) **Rahvusvah reg jrk**

H201300002

(15) **Registreeringu päev**

26.11.2012

(28) **Variantide arv**

1

(72) **Autor**

Tuncay Ceyran

(73) **Omanik**

Dernek Grup Elektrik Elektronik Diş Ticaret Ve Sanayi Limited Şirketi,  
Kartalpepe Mahallesi, Teyyareci Nurettin Sokak, Funda Apt. No: 2, Daire,  
Bakirköy - İstanbul, TR

**WIPO Rahvusvah Tööstusdisainilahenduste  
Bülletääni nr, kus registreering on avaldatud** 04/2013

(55) **Reproduksioon**

DM/079925-1

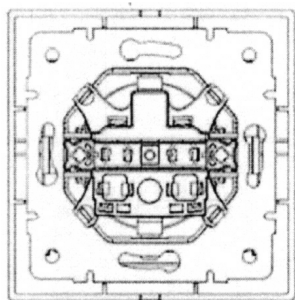
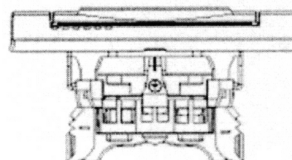
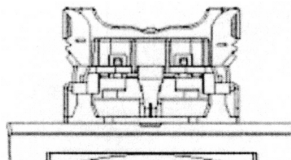
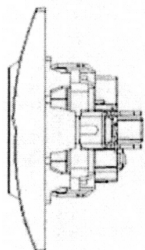
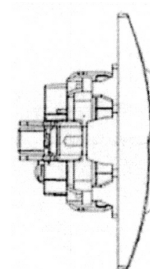
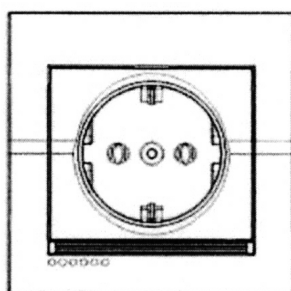
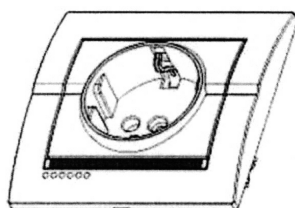

(11) **Rahvusvah reg nr**

**DM/079925**

(51) **Klass: 13-03**

(21) **Rahvusvah reg jrk**

H201300002A

(15) **Registreeringu päev**

26.11.2012

(28) **Variantide arv**

1

(72) **Autor**

Tuncay Ceyran

(73) **Omanik**

Dernek Grup Elektrik Elektronik Dış Ticaret Ve Sanayi Limited Şirketi,  
Kartalpe Mahallesi, Teyyareci Nurettin Sokak, Funda Apt. No: 2, Daire,  
Bakirköy - İstanbul, TR

**WIPO Rahvusvah Tööstusdisainilahenduste  
Bülletääni nr, kus registreering on avaldatud**

04/2013

(55) **Reproduksioon**

DM/079925-1

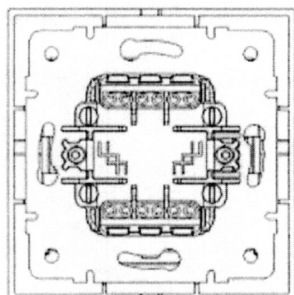
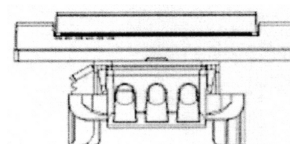
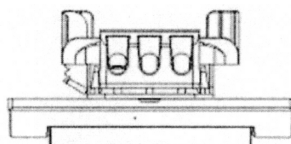
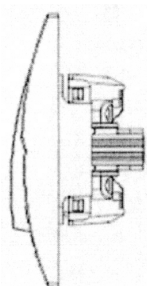
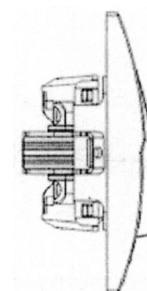
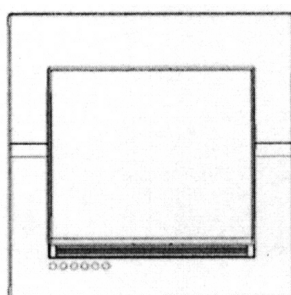
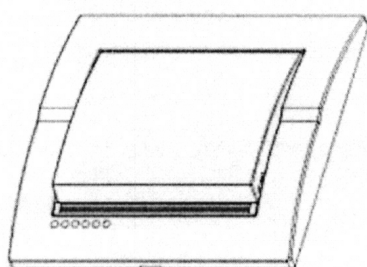

(11) **Rahvusvah reg nr**

**DM/079925**

(51) Klass: **13-03**

(21) **Rahvusvah reg jrk**

H201300002B

(15) **Registreeringu päev**

26.11.2012

(28) **Variantide arv**

1

(72) **Autor**

Tuncay Ceyran

(73) **Omanik**

Dernek Grup Elektrik Elektronik Diş Ticaret Ve Sanayi Limited Şirketi,  
Kartalpe Mahallesi, Teyyareci Nurettin Sokak, Funda Apt. No: 2, Daire,  
Bakirköy - İstanbul, TR

**WIPO Rahvusvah Tööstusdisainilahenduste  
Bülletääni nr, kus registreering on avaldatud**

04/2013

(55) **Reproduksioon**

DM/079925-1

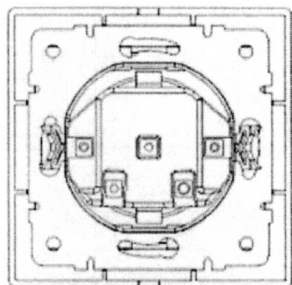
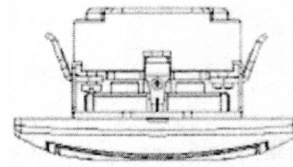
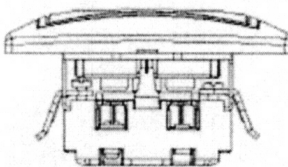
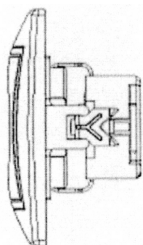
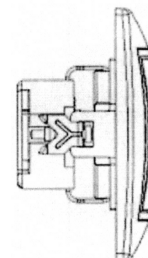
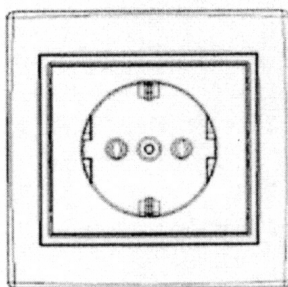
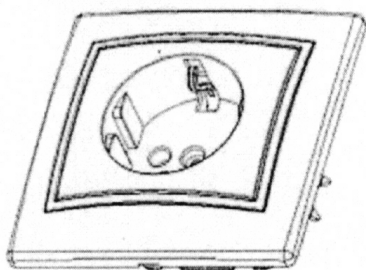

(11) **Rahvusvah reg nr**

**DM/079925**

(51) **Klass: 13-03**

(21) **Rahvusvah reg jrk**

H201300002C

(15) **Registreeringu päev**

26.11.2012

(28) **Variantide arv**

1

(72) **Autor**

Tuncay Ceyran

(73) **Omanik**

Dernek Grup Elektrik Elektronik Dış Ticaret Ve Sanayi Limited Şirketi,  
Kartalpe Mahallesi, Teyyareci Nurettin Sokak, Funda Apt. No: 2, Daire,  
Bakirköy - İstanbul, TR

**WIPO Rahvusvah Tööstusdisainilahenduste  
Bülletääni nr, kus registreering on avaldatud**

04/2013

(55) **Reproduksioon**

DM/079925-1

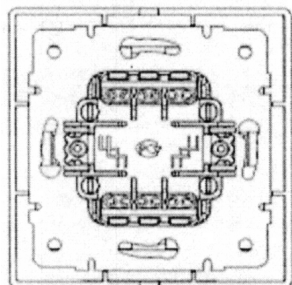
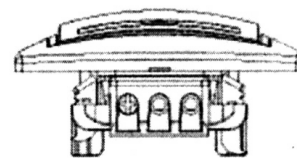
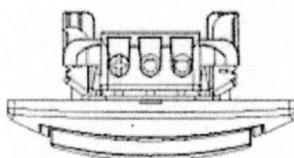
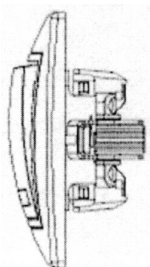
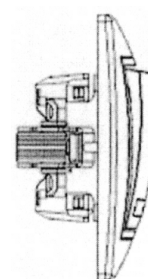
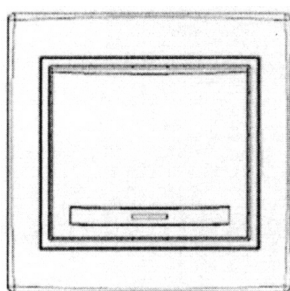
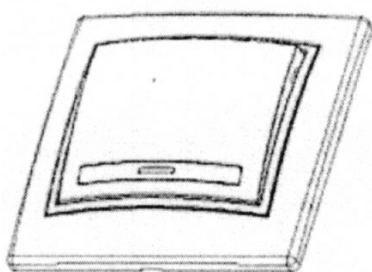



(11) **Rahvusvah reg nr****DM/079925**(51) Klass: **13-03**(21) **Rahvusvah reg jrk**

H201300002D

(15) **Registreeringu päev**

26.11.2012

(28) **Variantide arv**

1

(72) **Autor**

Tuncay Ceyran

(73) **Omanik**Dernek Grup Elektrik Elektronik Diş Ticaret Ve Sanayi Limited Şirketi,  
Kartalpepe Mahallesi, Teyyareci Nurettin Sokak, Funda Apt. No: 2, Daire,  
Bakirköy - İstanbul, TR**WIPO Rahvusvah Tööstusdisainilahenduste  
Bülletääni nr, kus registreering on avaldatud**

04/2013

(55) **Reproduksioon**

DM/079925-1

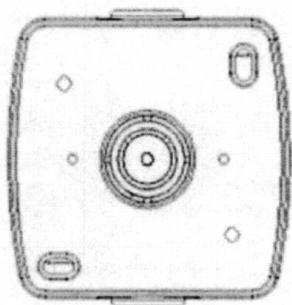
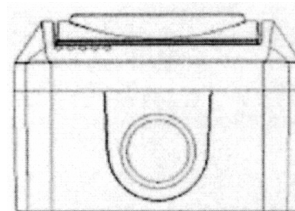
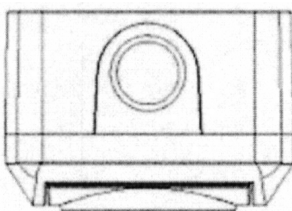
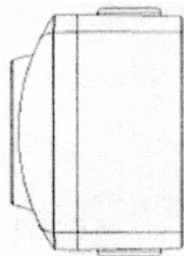
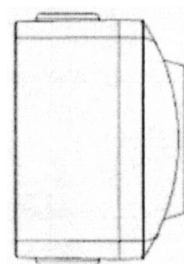
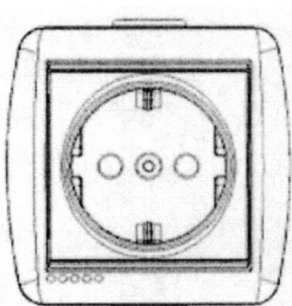
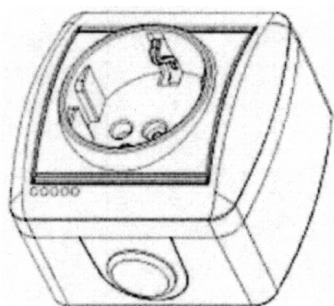

(11) **Rahvusvah reg nr**

**DM/080432**

(51) Klass: **26-06**

(21) **Rahvusvah reg jrk**

H201300005

(15) **Registreeringu päev**

21.03.2013

(28) **Variantide arv**

2

(72) **Autor**

Frédéric Hayez

Rémi Maliar

Cyril Herbin

Benony Grigorescu

VALEO VISION, 34 rue Saint-André, F-93012 BOBIGNY Cedex, FR

(73) **Omanik**

**WIPO Rahvusvah Tööstusdisainilahenduste**

**Bülletääni nr, kus registreering on avaldatud** 13/2013

(55) **Reproduksioon**

DM/080432-1

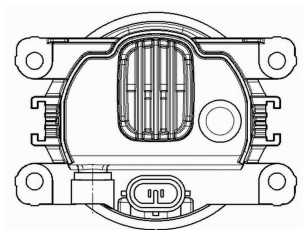
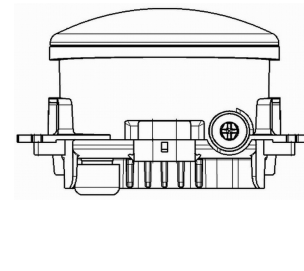
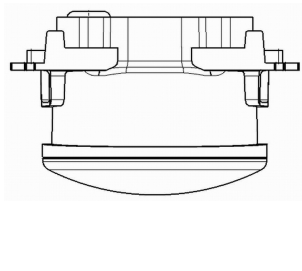
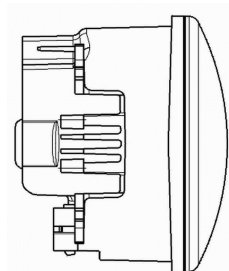
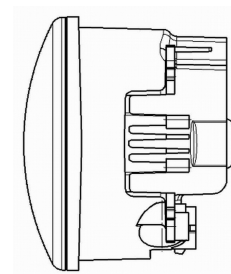
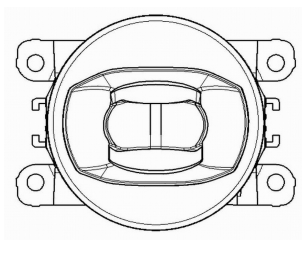
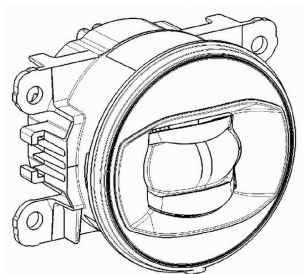

DM/080432-2

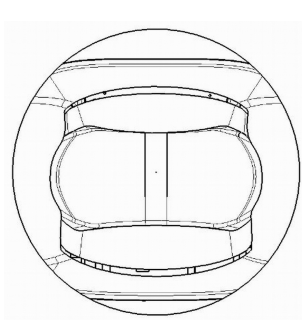
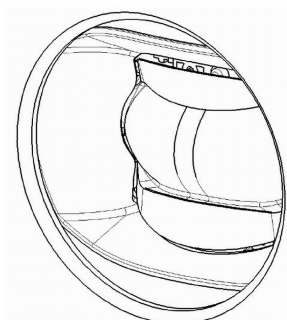

(11) **Rahvusvah reg nr**

**DM/080894**

(51) Klass: **09-05**

(21) **Rahvusvah reg jrk**

H201300007

(15) **Registreeringu päev**

18.04.2013

(28) **Variantide arv**

1

(72) **Autor**

Marcin Drag

(73) **Omanik**

Van Genechten Packaging, Raadsherenstraat 2, B-2300 Turnhout, BE

**WIPO Rahvusvah Tööstusdisainilahenduste**

**Bülletääni nr, kus registreering on avaldatud** 21/2013

(55) **Reproduktsoon**

DM/080894-1

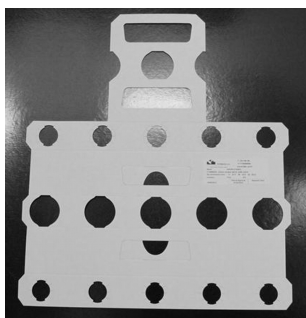

**III. MUUD REGISTRIKANDED****REGISTREERINGU KEHTIVUSE PIKENDAMINE**

Reg nr	Registreeringu pikendatud kehtivusaja lõppemise päev
--------	--

00226	10.03.2018	00276	18.06.2018	00860	11.06.2018
00267	18.06.2018	00277	18.06.2018	00863	18.09.2018
00270	18.06.2018	00278	18.06.2018	00875	11.11.2018
00271	18.06.2018	00827	27.06.2018	01434	24.04.2018
00272	18.06.2018	00856	11.06.2018	01435	28.04.2018
00273	18.06.2018	00858	06.08.2018	01436	28.04.2018

**REGISTREERINGU ANDMETE MUUDATUSED**

Reg nr	Muutunud andmed	Registrikande jõustumise päev
00875	Finlandia Vodka Worldwide Ltd, Porkkalankatu 24, 00180 Helsinki, FI	27.05.2013

**TÖÖSTUSDISAINILAHENDUSE LITSENTSIMINE****Litsentsi kohta tehtud kande kustutamine**

Reg nr: 01374  
 Registrikande jõustumise päev: 29.04.2013

**REGISTREERINGU KUSTUTAMINE**

"Tööstusdisaini kaitse seaduse" paragrahvi 77 lõike 1 alusel on registrist kustutatud järgmised tööstusdisainilahendused:

Reg nr	Kustutamise kande jõustumise päev
--------	-----------------------------------

00722	01.11.2012	00747	13.12.2012	01390	26.11.2012	01400	20.12.2012
00729	20.11.2012	00750	17.12.2012	01391	14.12.2012	01401	20.12.2012
00731	25.11.2012	01377	24.10.2012	01392	14.12.2012	01402	20.12.2012
00740	13.12.2012	01378	05.11.2012	01393	14.12.2012	01403	20.12.2012
00741	13.12.2012	01379	08.11.2012	01394	20.12.2012	01404	20.12.2012
00742	13.12.2012	01381	11.12.2012	01395	20.12.2012	01405	20.12.2012
00743	13.12.2012	01382	11.12.2012	01396	20.12.2012	01406	20.12.2012
00744	13.12.2012	01383	12.12.2012	01397	20.12.2012	01407	20.12.2012
00745	13.12.2012	01384	12.12.2012	01398	20.12.2012		
00746	13.12.2012	01385	12.12.2012	01399	20.12.2012		

## IV. LOENDID

REGISTREERITUD TÖÖSTUSDISAINILAHENDUSTE REGISTREERIMISE TAOTLUSTE  
NUMBRILINE LOEND

Registreerimis- taotluse number	Registreeringu number
------------------------------------	--------------------------

D201300018	01813	D201300030	01820
D201300021	01814	D201300031	01821
D201300026	01815	D201300032	01822
D201300026A	01816	D201300033	01823
D201300027	01817	D201300034	01824
D201300028	01818	D201300035	01825
D201300029	01819	D201300036	01826

RAHVUSVAHELISELT REGISTREERITUD TÖÖSTUSDISAINILAHENDUSTE  
NUMBRILINE LOEND

Rahvusvah reg jrk	Rahvusvah reg nr
-------------------	------------------

H201200013	DM/079285
H201200014	DM/079286
H201200015	DM/079288
H201200016	DM/079289
H201300002	DM/079925
H201300002A	DM/079925
H201300002B	DM/079925
H201300002C	DM/079925
H201300002D	DM/079925
H201300005	DM/080432
H201300007	DM/080894

## V. TÖÖSTUSDISAINIALASED ÕIGUSAKTID JA MUU INFO

RIIKLIKUS PATENDIVOLNIKE REGISTRIS REGISTREERITUD PATENDIVOLNIKE NIMEKIRI  
(seisuga 4. jaanuar 2013)

Register on asutatud 1. septembril 2001. a Vabariigi Valitsuse 7. augusti 2001. a määrusega nr 271 "Riikliku patendivolinike registri asutamine ja registri pidamise põhimäärus" (RT I 2001, 70, 426) patendivoliniku seaduse § 21 alusel (RT I 2001, 27, 151).

## TEGEVUSVALDKOND: KAUBAMÄRK, TÖÖSTUSDISAINILAHENDUS JA GEOGRAAFILINE TÄHIS

<b>Arno ANIJALG</b>	<b>Patendibüroo Ustervall OÜ</b> Kivi 21-6 51009 Tartu telefon: 744 1980 telefaks: 744 1785 e-post: anijalg@ustervall.ee http://www.ustervall.ee võõrkeeled: saksa, vene	<b>Juhan HÄMMALOV</b>	<b>INTELS Patendibüroo OÜ</b> Magasini 12 51005 Tartu telefon: 742 0401 telefaks: 742 0326 e-post: intels@intels.ee http://www.intels.ee võõrkeeled: inglise, saksa, vene
<b>Aivo ARULA</b>	<b>Patendibüroo Käosaar &amp; Co OÜ</b> Tähe 94 50107 Tartu telefon: 738 3051 telefaks: 738 3055 e-post: info@kaosaar.ee http://www.kaosaar.ee võõrkeeled: inglise, vene	<b>Martin JÕGI</b>	<b>LASVET Patendibüroo OÜ</b> Suurtüki 4a, 10133 Tallinn telefon: 640 6600 telefaks: 640 6604 e-post: lasvet@lasvet.ee http://www.lasvet.ee võõrkeeled: soome, vene, inglise
<b>Martina BÖCKLER-LORVI</b>	<b>LASVET Patendibüroo OÜ</b> Suurtüki 4a, 10133 Tallinn pk 3136, 10505 Tallinn telefon: 640 6600 telefaks: 640 6604 e-post: lasvet@lasvet.ee http://www.lasvet.ee võõrkeeled: inglise, soome	<b>Uno JÄÄGER</b>	<b>Inseneribüroo Uneko OÜ</b> Rüütli 51a, 80010 Pärnu telefon: 447 1021 telefaks: 447 1001 GSM: 515 1844 e-post: info@uneko.ee http://www.uneko.ee võõrkeeled: inglise, soome, vene
<b>Indrek EELMETS</b>	<b>Advokaadibüroo SORAINEN AS</b> Pärnu mnt 15 10141 Tallinn telefon: 640 0900 telefaks: 640 0901 e-post: estonia@sorainen.com http://www.sorainen.com võõrkeeled: inglise, vene, soome	<b>Sirje KAHU</b>	<b>Patendibüroo Ustervall OÜ</b> Kivi 21-6 51009 Tartu telefon: 744 1980 telefaks: 744 1785 e-post: skahu@ustervall.ee http://www.ustervall.ee võõrkeeled: inglise, vene
<b>Alla HÄMMALOV</b>	<b>INTELS Patendibüroo OÜ</b> Magasini 12 51005 Tartu telefon: 742 0401 telefaks: 742 0326 e-post: intels@intels.ee http://www.intels.ee võõrkeeled: inglise, poola, vene	<b>Lembit KALEV</b>	<b>Patendibüroo ROOSILLA OÜ</b> Järveotsa tee 39-61 13520 Tallinn telefon: 657 1722, 657 5381 telefaks: 657 5381 GSM: 511 9951 e-post: roosilla@roosilla.ee http://www.roosilla.ee võõrkeeled: inglise, vene

- Anneli KANG** **OÜ Synest**  
pk 977, 13402 Tallinn  
telefon: 660 9786  
telefaks: 660 9787  
e-post: anneli@synest.ee  
võõrkeeled: inglise, saksa, vene,  
prantsuse, soome, rootsi
- Anneli KAPP** **Patendibüroo Käosaar & Co OÜ**  
Tähe 94  
50107 Tartu  
telefon: 738 3051  
telefaks: 738 3055  
e-post: info@kaosaar.ee  
http://www.kaosaar.ee  
võõrkeeled: inglise, vene
- Urmas KAULER** **Patendibüroo TURVAJA OÜ**  
Liivalaia 22  
10118 Tallinn  
telefon: 640 3109  
telefaks: 640 3105  
e-post: turvaja@turvaja.ee  
http://www.turvaja.ee  
võõrkeeled: inglise, vene, soome
- Urmas KERNU** **AAA Patendibüroo OÜ**  
Tartu mnt 16  
10117 Tallinn  
pk 3926, 10509 Tallinn  
telefon: 660 5910, 660 5911  
telefaks: 660 5912  
e-post: aaa@aaa.ee  
http://www.aaa.ee  
võõrkeeled: inglise, saksa,  
soome, vene
- Ljubov KESSELMAN** **OÜ Kesna**  
Tedre 77-52  
10616 Tallinn  
telefon: 660 8068  
telefaks: 660 8069  
e-post: kesna@kesna.ee  
http://www.kesna.ee  
võõrkeeled: inglise, vene
- Marina KESSELMAN** **OÜ Kesna**  
Tedre 77-52  
10616 Tallinn  
telefon: 660 8068  
telefaks: 660 8069  
e-post: kesna@kesna.ee  
http://www.kesna.ee  
võõrkeeled: inglise, saksa, vene
- Raivo KOITEL**
- Katrin KOITEL-VEIDIK**
- Mart Enn KOPPEL**
- Anna KOSAR**
- Heinrich KRUPP**
- Jüri KÄOSAAR**
- Patendi- & Kaubamärgibüroo Koitel OÜ**  
Tartu mnt 65  
10115 Tallinn  
pk 1759, 10902 Tallinn  
telefon: 603 3260  
telefaks: 603 3261  
e-post: koitel@koitel.ee  
http://www.koitel.ee  
võõrkeeled: inglise, soome, vene
- Patendi- & Kaubamärgibüroo Koitel OÜ**  
Tartu mnt 65  
10115 Tallinn  
pk 1759, 10902 Tallinn  
telefon: 603 3260  
telefaks: 603 3261  
e-post: koitel@koitel.ee  
http://www.koitel.ee  
võõrkeeled: inglise, soome
- KOPPEL patendibüroo OÜ**  
Roseni 10-151  
10111 Tallinn  
telefon: 677 4136  
telefaks: 677 4138  
e-post: info@koppelpb.com  
http://www.koppelpb.com  
võõrkeeled: inglise, vene, soome
- Patendi- & Kaubamärgibüroo Koitel OÜ**  
Tartu mnt 65  
10115 Tallinn  
pk 1759, 10902 Tallinn  
telefon: 603 3260  
telefaks: 603 3261  
e-post: koitel@koitel.ee  
http://www.koitel.ee  
võõrkeeled: inglise, vene
- Patendibüroo TURVAJA OÜ**  
Liivalaia 22  
10118 Tallinn  
telefon: 640 3109  
telefaks: 640 3105  
e-post: turvaja@turvaja.ee  
http://www.turvaja.ee  
võõrkeeled: saksa, vene
- Patendibüroo Käosaar & Co OÜ**  
Tähe 94  
50107 Tartu  
telefon: 738 3051  
telefaks: 738 3055  
e-post: info@kaosaar.ee  
http://www.kaosaar.ee  
võõrkeeled: inglise, vene

<b>Kalev KÄOSAAR</b>	<b>Patendibüroo Käosaar &amp; Co OÜ</b> Suur-Patarei 2 10415 Tallinn telefon: 637 9484 telefaks: 637 9485 e-post: kalev.kaosaar@kaosaar.ee http://www.kaosaar.ee võõrkeeled: inglise, vene	<b>Lembit MITT</b>	<b>AAA Patendibüroo OÜ</b> Tartu mnt 16, 10117 Tallinn pk 3926, 10509 Tallinn telefon: 660 5910, 660 5911 telefaks: 660 5912 e-post: aaa@aaa.ee http://www.aaa.ee võõrkeeled: inglise, vene
<b>Kärt LAIGU</b>	kutsetegevus on peatatud	<b>Ott MOORLAT</b>	<b>OÜ Moorlat &amp; Ko Patendibüroo</b> pk 4730, 13503 Tallinn telefon: 648 2085 telefaks: 654 2844 e-post: ott.moorlat@moorlat.ee http://www.moorlat.ee võõrkeeled: inglise, vene
<b>Kristjan LEPPIK</b>	<b>Patendibüroo TURVAJA OÜ</b> Liivalaia 22 10118 Tallinn telefon: 640 3109 telefaks: 640 3105 e-post: turvaja@turvaja.ee http://www.turvaja.ee võõrkeeled: inglise, vene	<b>Anfia MORNA</b>	<b>Patendibüroo TURVAJA OÜ</b> Liivalaia 22, 10118 Tallinn telefon: 640 3109 telefaks: 640 3105 e-post: turvaja@turvaja.ee http://www.turvaja.ee võõrkeeled: inglise, vene
<b>Reet MAASIKAMÄE</b>	<b>Patendibüroo Kaitsepurus OÜ</b> Mulla 4-3 10611 Tallinn telefon: 673 9097, 566 75197 telefaks: 677 4844 e-post: purus@kaitsepurus.ee http://www.kaitsepurus.ee võõrkeeled: inglise, vene	<b>Mari MUST</b>	<b>Raidla Lejins &amp; Norcoux Advokaadibüroo OÜ</b> Roosikrantsi 2, 10119 Tallinn telefon: 640 7170 telefaks: 640 7171 e-post: mari.must@rln.ee http://www.rln.ee võõrkeeled: inglise, soome
<b>Ingrid MATSINA</b>	<b>AAA Patendibüroo OÜ</b> Tartu mnt 16, 10117 Tallinn pk 3926, 10509 Tallinn telefon: 660 5910, 660 5911 telefaks: 660 5912 e-post: aaa@aaa.ee http://www.aaa.ee võõrkeeled: inglise, vene, saksa, prantsuse	<b>Tõnu NELNAS</b>	<b>AAA Patendibüroo OÜ</b> Tartu mnt 16, 10117 Tallinn pk 3926, 10509 Tallinn telefon: 660 5910, 660 5911 telefaks: 660 5912 e-post: aaa@aaa.ee http://www.aaa.ee võõrkeeled: inglise, vene, soome
<b>Raivo MATSOO</b>	<b>RM Hirvela Patendibüroo OÜ</b> Endla 3, 10122 Tallinn telefon: 614 0816 telefaks: 614 0818 e-post: hirvela@hirvela.ee võõrkeeled: inglise, vene	<b>Jüri OLT</b>	<b>Danteks OÜ</b> Tiigi 6, 51003 Tartu telefon: 508 1671 telefaks: 730 2844 e-post: jyri@danteks.net http://www.danteks.net võõrkeeled: inglise, saksa, soome, vene
<b>Elle MELLIK</b>	<b>AAA Patendibüroo OÜ</b> Tartu mnt 16, 10117 Tallinn pk 3926, 10509 Tallinn telefon: 660 5910, 660 5911 telefaks: 660 5912 e-post: aaa@aaa.ee http://www.aaa.ee võõrkeeled: inglise, vene	<b>Jaak OSTRAT</b>	<b>LASVET Patendibüroo OÜ</b> Suurtüki 4a, 10133 Tallinn pk 3136, 10505 Tallinn telefon: 640 6600 telefaks: 640 6604 e-post: lasvet@lasvet.ee http://www.lasvet.ee võõrkeeled: inglise, saksa, soome, vene
<b>Mikas MINIOTAS</b>	<b>AAA Patendibüroo OÜ</b> Tartu mnt 16, 10117 Tallinn pk 3926, 10509 Tallinn telefon: 660 5910 telefaks: 660 5912 e-post: aaa@aaa.ee http://www.aaa.ee võõrkeeled: leedu, inglise, vene		



<b>Villu PAVELTS</b>	<b>LASVET Patendibüroo OÜ</b> Suurtüki 4a, 10133 Tallinn pk 3136, 10505 Tallinn telefon: 640 6600 telefaks: 640 6604 e-post: lasvet@lasvet.ee http://www.lasvet.ee võõrkeeled: inglise, soome, vene	<b>Margus SARAP</b>	<b>Sarap ja Partnerid Patendibüroo</b> Riia 185A, 51014 Tartu telefon: 747 7058 telefaks: 747 7059 e-post: patent@patent.ee http://www.patent.ee võõrkeeled: inglise, vene
<b>Kaie PUUR</b>	<b>Patendibüroo RestMark OÜ</b> WTC Tallinn Ahtri 8, 10151 Tallinn <b>Patendibüroo RestMark OÜ</b> Kompanii 1c, 51004 Tartu telefon: 655 9803 telefaks: 747 7059 e-post: kaie.puur@restmark.ee http://www.restmark.ee võõrkeeled: inglise, vene, saksa	<b>Almar SEHVER</b>	<b>AAA Patendibüroo OÜ</b> Tartu mnt 16, 10117 Tallinn pk 3926, 10509 Tallinn telefon: 660 5910, 660 5911 telefaks: 660 5912 e-post: aaa@aaa.ee http://www.aaa.ee võõrkeeled: inglise, vene
<b>Linnar PUUSEPP</b>	<b>LASVET Patendibüroo OÜ</b> Suurtüki 4a, 10133 Tallinn pk 3136, 10505 Tallinn telefon: 640 6600 telefaks: 640 6604 e-post: lasvet@lasvet.ee http://www.lasvet.ee võõrkeeled: inglise, vene	<b>Harald TEHVER</b>	<b>Patendibüroo TURVAJA OÜ</b> Liivalaia 22, 10118 Tallinn telefon: 640 3109 telefaks: 640 3105 e-post: turvaja@turvaja.ee http://www.turvaja.ee võõrkeeled: inglise, saksa, vene
<b>Riina PÄRN</b>	<b>INTELS Patendibüroo OÜ</b> Magasini 12, 51005 Tartu telefon: 742 0401 telefaks: 742 0326 e-post: intels@intels.ee http://www.intels.ee võõrkeeled: inglise, vene	<b>Kadri TOOMSALU</b>	kutsetegevus on peatatud
<b>Tarmo ROSMAN</b>	<b>Rosman ja Partnerid OÜ</b> pk 652, 12602 Tallinn telefon: 656 1450 telefaks: 656 1450 e-post: tarman@cc.ttu.ee võõrkeeled: saksa, inglise, ungari, vene	<b>Olga TREUFELDT</b>	<b>Patendibüroo TURVAJA OÜ</b> Liivalaia 22 10118 Tallinn telefon: 640 3109 telefaks: 640 3105 e-post: turvaja@turvaja.ee http://www.turvaja.ee võõrkeeled: inglise, vene
<b>Arvo SALUMÄE</b>	<b>OÜ Amende Patendibüroo</b> J. Köleri 8, 10150 Tallinn telefon: 648 6125 telefaks: 641 0174 e-post: amende@hot.ee võõrkeeled: inglise, saksa, soome, vene	<b>Enn URGAS</b>	<b>Patendibüroo TURVAJA OÜ</b> Liivalaia 22, 10118 Tallinn telefon: 640 3109 telefaks: 640 3105 e-post: turvaja@turvaja.ee http://www.turvaja.ee võõrkeeled: inglise, vene
		<b>Juta-Maris UUSTALU</b>	<b>OÜ Amende Patendibüroo</b> J. Köleri 8, 10150 Tallinn telefon: 648 6125 telefaks: 641 0174 e-post: amende@hot.ee võõrkeeled: inglise, vene

**LIST OF PATENT ATTORNEYS, REGISTERED IN  
THE ESTONIAN STATE REGISTER OF PATENT ATTORNEYS**  
(by 4 January 2013)

Register is established on September 1<sup>st</sup> 2001

**FIELD OF ACTIVITY: TRADEMARKS, INDUSTRIAL DESIGNS AND GEOGRAPHICAL INDICATIONS**

<b>Arno ANIJALG</b>	<b>Patendibüroo Ustervall OÜ</b> Kivi 21-6 51009 Tartu, Estonia Phone: +372 744 1980 Fax: +372 744 1785 E-mail: anijalg@ustervall.ee Http://www.ustervall.ee German, Russian, Estonian	<b>Juhan HÄMMALOV</b>	<b>INTELS Patent and Trademark Agency</b> Magasini 12 51005 Tartu, Estonia Phone: +372 742 0401 Fax: +372 742 0326 E-mail: intels@intels.ee Http://www.intels.ee English, German, Russian, Estonian
<b>Aivo ARULA</b>	<b>Patent Agency Käosaar &amp; Co</b> Tähe Str. 94 50107 Tartu, Estonia Phone: +372 738 3051 Fax: +372 738 3055 E-mail: info@kaosaar.ee Http://www.kaosaar.ee English, Russian, Estonian	<b>Martin JÕGI</b>	<b>Lasvet Ltd.</b> P.O. Box 3136 10505 Tallinn, Estonia Phone: +372 640 6600 Fax: +372 640 6604 E-mail: lasvet@lasvet.ee Http://www.lasvet.ee Finnish, Russian, English, Estonian
<b>Martina BÖCKLER-LORVI</b>	<b>Lasvet Ltd.</b> P.O. Box 3136 10505 Tallinn, Estonia Phone: +372 640 6600 Fax: +372 640 6604 E-mail: lasvet@lasvet.ee Http://www.lasvet.ee English, Finnish, Estonian	<b>Uno JÄÄGER</b>	<b>Inseneribüroo Uneko Ltd.</b> Rüütli 51a 80010 Pärnu, Estonia Phone: +372 447 1021 Fax: +372 447 1001 GSM: +372 515 1844 E-mail: info@uneko.ee Http://www.uneko.ee English, Finnish, Russian, Estonian
<b>Indrek EELMETS</b>	law firm SORAINEN Pärnu Road 15 10141 Tallinn, Estonia Phone: +372 640 0900 Fax: +372 640 0901 E-mail: estonia@sorainen.com Http://www.sorainen.com English, Russian, Finnish, Estonian	<b>Sirje KAHU</b>	<b>Patendibüroo Ustervall OÜ</b> Kivi 21-6 51009 Tartu, Estonia Phone: +372 744 1980 Fax: +372 744 1785 E-mail: skahu@ustervall.ee Http://www.ustervall.ee English, Russian, Estonian
<b>Alla HÄMMALOV</b>	<b>INTELS Patent and Trademark Agency</b> Magasini 12 51005 Tartu, Estonia Phone: +372 742 0401 Fax: +372 742 0326 E-mail: intels@intels.ee Http://www.intels.ee English, Polish, Russian, Estonian	<b>Lembit KALEV</b>	<b>Patent Bureau ROOSILLA Ltd.</b> Järveotsa Road 39-61 13520 Tallinn, Estonia Phone: +372 657 1722 +372 657 5381 Fax: +372 657 5381 GSM: +372 511 9951 E-mail: roosilla@roosilla.ee Http://www.roosilla.ee English, Russian, Estonian

- Anneli KANG**      **Synest Ltd.**  
P.O. Box 977  
13402 Tallinn, Estonia  
Phone: +372 660 9786  
Fax: +372 660 9787  
E-mail: anneli@synest.ee  
English, German, Russian,  
French, Finnish, Swedish,  
Estonian
- Anneli KAPP**      **Patent Agency Käosaar & Co**  
Tähe Str. 94  
50107 Tartu, Estonia  
Phone: +372 738 3051  
Fax: +372 738 3055  
E-mail: info@kaosaar.ee  
Http://www.kaosaar.ee  
English, Russian, Estonian
- Urmas KAULER**      **Patendibüroo TURVAJA OÜ**  
Liivalaia 22  
10118 Tallinn, Estonia  
Phone: +372 640 3109  
Fax: +372 640 3105  
E-mail: turvaja@turvaja.ee  
Http://www.turvaja.ee  
English, Russian, Finnish,  
Estonian
- Urmas KERNU**      **AAA Legal Services**  
Tartu Road 16  
10117 Tallinn, Estonia  
P.O. Box 3926  
10509 Tallinn, Estonia  
Phone: +372 660 5910  
+372 660 5911  
Fax: +372 660 5912  
E-mail: aaa@aaa.ee  
Http://www.aaa.ee  
English, German, Finnish,  
Russian, Estonian
- Ljubov KESSELMAN**      **Kesna Ltd.**  
Tedre Str. 77-52  
10616 Tallinn, Estonia  
Phone: +372 660 8068  
Fax: +372 660 8069  
E-mail: kesna@kesna.ee  
Http://www.kesna.ee  
English, Russian, Estonian
- Marina KESSELMAN**      **Kesna Ltd.**  
Tedre Str. 77-52  
10616 Tallinn, Estonia  
Phone: +372 660 8068  
Fax: +372 660 8069  
E-mail: kesna@kesna.ee  
Http://www.kesna.ee  
English, German, Russian,  
Estonian
- Raivo KOITEL**      **Patent & Trademark Agency  
Koitel**  
Tartu Road 65  
10115 Tallinn, Estonia  
P.O. Box 1759  
10902 Tallinn, Estonia  
Phone: +372 603 3260  
Fax: +372 603 3261  
E-mail: koitel@koitel.ee  
Http://www.koitel.ee  
English, Finnish, Russian,  
Estonian
- Katrin  
KOITEL-VEIDIK**      **Patent & Trademark Agency  
Koitel**  
Tartu Road 65  
10115 Tallinn, Estonia  
P.O. Box 1759  
10902 Tallinn, Estonia  
Phone: +372 603 3260  
Fax: +372 603 3261  
E-mail: koitel@koitel.ee  
Http://www.koitel.ee  
English, Finnish, Estonian
- Mart Enn KOPPEL**      **KOPPEL patendibüroo OÜ**  
Roseni 10-151  
10111 Tallinn, Estonia  
Phone: +372 677 4136  
Fax: +372 677 4138  
E-mail: info@koppelpb.com  
Http://www.koppelpb.com  
English, Russian, Finnish,  
Estonian
- Anna KOSAR**      **Patent & Trademark Agency  
Koitel**  
Tartu Road 65  
10115 Tallinn, Estonia  
P.O. Box 1759  
10902 Tallinn, Estonia  
Phone: +372 603 3260  
Fax: +372 603 3261  
E-mail: koitel@koitel.ee  
Http://www.koitel.ee  
English, Russian, Estonian
- Heinrich KRUPP**      **Patendibüroo TURVAJA OÜ**  
Liivalaia 22  
10118 Tallinn, Estonia  
Phone: +372 640 3109  
Fax: +372 640 3105  
E-mail: turvaja@turvaja.ee  
Http://www.turvaja.ee  
German, Russian, Estonian

- Jüri KÄOSAAR**      **Patent Agency Käosaar & Co**  
Tähe Str. 94  
50107 Tartu, Estonia  
Phone: +372 738 3051  
Fax: +372 738 3055  
E-mail: info@kaosaar.ee  
Http://www.kaosaar.ee  
English, Russian, Estonian
- Kalev KÄOSAAR**      **Patent Agency Käosaar & Co**  
Suur-Patarei 2  
10415 Tallinn, Estonia  
Phone: +372 637 9484  
Fax: +372 637 9485  
E-mail: kalev.kaosaar@kaosaar.ee  
Http://www.kaosaar.ee  
English, Russian, Estonian
- Kärt LAIGU**      professional activities have been  
suspended
- Kristjan LEPPIK**      **Patendibüroo TURVAJA OÜ**  
Liivalaia 22  
10118 Tallinn, Estonia  
Phone: +372 640 3109  
Fax: +372 640 3105  
E-mail: turvaja@turvaja.ee  
Http://www.turvaja.ee  
English, Russian, Estonian
- Reet MAASIKAMÄE**      **Patent Bureau Kaitsepurus**  
Mulla Str. 4-3  
10611 Tallinn, Estonia  
Phone: +372 673 9097  
+372 566 75197  
Fax: +372 677 4844  
E-mail: purus@kaitsepurus.ee  
Http://www.kaitsepurus.ee  
English, Russian, Estonian
- Ingrid MATSINA**      **AAA Legal Services**  
Tartu Road 16  
10117 Tallinn, Estonia  
P.O. Box 3926  
10509 Tallinn, Estonia  
Phone: +372 660 5910  
+372 660 5911  
Fax: +372 660 5912  
E-mail: aaa@aaa.ee  
Http://www.aaa.ee  
English, Russian, Greman,  
French, Estonian
- Raivo MATSOO**      **RM Hirvela Patent Bureau  
Ltd**  
Endla 3, 10122 Tallinn, Estonia  
Phone: +372 614 0816  
Fax: +372 614 0818  
E-mail: hirvela@hirvela.ee  
English, Russian, Estonian
- Elle MELLIK**
- AAA Legal Services**  
Tartu Road 16  
10117 Tallinn, Estonia  
P.O. Box 3926  
10509 Tallinn, Estonia  
Phone: +372 660 5910  
+372 660 5911  
Fax: +372 660 5912  
E-mail: aaa@aaa.ee  
Http://www.aaa.ee  
English, Russian, Estonian
- Mikas MINIOTAS**
- AAA Legal Services**  
Tartu Road 16  
10117 Tallinn, Estonia  
P.O. Box 3926  
10509 Tallinn, Estonia  
Phone: +372 660 5910  
Fax: +372 660 5912  
E-mail: aaa@aaa.ee  
Http://www.aaa.ee  
Lithuanian, English, Russian,  
Estonian
- Lembit MITT**
- AAA Legal Services**  
Tartu Road 16  
10117 Tallinn, Estonia  
P.O. Box 3926  
10509 Tallinn, Estonia  
Phone: +372 660 5910  
+372 660 5911  
Fax: +372 660 5912  
E-mail: aaa@aaa.ee  
Http://www.aaa.ee  
English, Russian, Estonian
- Ott MOORLAT**
- Moorlat & Co Ltd.  
Patent Bureau**  
P.O. Box 4730  
13503 Tallinn, Estonia  
Phone: +372 648 2085  
Fax: +372 654 2844  
E-mail: ott.moorlat@moorlat.ee  
Http://www.moorlat.ee  
English, Russian, Estonian
- Anfia MORNA**
- Patendibüroo TURVAJA OÜ**  
Liivalaia 22  
10118 Tallinn, Estonia  
Phone: +372 640 3109  
Fax: +372 640 3105  
E-mail: turvaja@turvaja.ee  
Http://www.turvaja.ee  
English, Russian, Estonian
- Mari MUST**
- Raidla Lejins & Norcous  
Advokaadibüroo OÜ**  
Roosikrantsi 2  
10119 Tallinn, Estonia  
Phone: +372 640 7170  
Fax: +372 640 7171  
E-mail: mari.must@rln.ee  
Http:// www.rln.ee  
English, Finnish, Estonian

<b>Tõnu NELAS</b>	<b>AAA Legal Services</b> Tartu Road 16 10117 Tallinn, Estonia P.O. Box 3926 10509 Tallinn, Estonia Phone: +372 660 5910 +372 660 5911 Fax: +372 660 5912 E-mail: aaa@aaa.ee Http://www.aaa.ee English, Russian, Finnish, Estonian	<b>Linnar PUUSEPP</b>	<b>Lasvet Ltd.</b> P.O. Box 3136 10505 Tallinn, Estonia Phone: +372 640 6600 Fax: +372 640 6604 E-mail: lasvet@lasvet.ee Http://www.lasvet.ee English, Russian, Estonian
<b>Jüri OLT</b>	<b>Danteks OÜ</b> Tiigi 6 51003 Tartu, Estonia Phone: +372 508 1671 Fax: +372 730 2844 E-mail: jyri@danteks.net Http://www.danteks.net English, German, Finnish, Russian, Estonian	<b>Riina PÄRN</b>	<b>INTELS Patent and Trademark Agency</b> Magasini 12 51005 Tartu, Estonia Phone: +372 742 0401 Fax: +372 742 0326 E-mail: intels@intels.ee Http://www.intels.ee English, Russian, Estonian
<b>Jaak OSTRAT</b>	<b>Lasvet Ltd.</b> P.O. Box 3136 10505 Tallinn, Estonia Phone: +372 640 6600 Fax: +372 640 6604 E-mail: lasvet@lasvet.ee Http://www.lasvet.ee English, German, Finnish, Russian, Estonian	<b>Tarmo ROSMAN</b>	<b>Rosman and Partners Ltd.</b> P.O. Box 652 12602 Tallinn, Estonia Phone: +372 656 1450 Fax: +372 656 1450 E-mail: tarman@cc.ttu.ee German, English, Hungarian, Russian, Estonian
<b>Villu PAVELTS</b>	<b>Lasvet Ltd.</b> P.O. Box 3136 10505 Tallinn, Estonia Phone: +372 640 6600 Fax: +372 640 6604 E-mail: lasvet@lasvet.ee Http://www.lasvet.ee English, Finnish, Russian, Estonian	<b>Arvo SALUMÄE</b>	<b>AMENDE Patent Agency Ltd.</b> J. Köleri 8, 10150 Tallinn, Estonia Phone: +372 648 6125 Fax: +372 641 0174 E-mail: amende@hot.ee English, German, Finnish, Russian, Estonian
<b>Kaie PUUR</b>	<b>Patendibüroo RestMark OÜ</b> WTC Tallinn Ahtri 8 10151 Tallinn, Estonia <b>Patendibüroo RestMark OÜ</b> Kompanii 1c 51004 Tartu, Estonia Phone: +372 655 9803 Fax: +372 747 7059 E-mail: kaie.puur@restmark.ee Http://www.restmark.ee English, Russian, German, Estonian	<b>Margus SARAP</b>	<b>Sarap ja Partnerid Patendibüroo</b> Riia 185A 51014 Tartu, Estonia Phone: +372 747 7058 Fax: +372 747 7059 E-mail: patent@patent.ee Http://www.patent.ee English, Russian, Estonian
		<b>Almar SEHVER</b>	<b>AAA Legal Services</b> Tartu Road 16 10117 Tallinn, Estonia P.O. Box 3926 10509 Tallinn, Estonia Phone: +372 660 5910 +372 660 5911 Fax: +372 660 5912 E-mail: aaa@aaa.ee Http://www.aaa.ee English, Russian, Estonian

**Harald TEHVER****Patendibüroo TURVAJA OÜ**

Liivalaia 22  
10118 Tallinn, Estonia  
Phone: +372 640 3109  
Fax: +372 640 3105  
E-mail: turvaja@turvaja.ee  
Http://www.turvaja.ee  
English, German, Russian,  
Estonian

**Enn URGAS****Patendibüroo TURVAJA OÜ**

Liivalaia 22  
10118 Tallinn, Estonia  
Phone: +372 640 3109  
Fax: +372 640 3105  
E-mail: turvaja@turvaja.ee  
Http://www.turvaja.ee  
English, Russian, Estonian

**Kadri TOOMSALU**

professional activities have been  
suspended

**Juta-Maris UUSTALU****AMENDE Patent Agency  
Ltd.**

J. Köleri 8, 10150 Tallinn,  
Estonia  
Phone: +372 648 6125  
Fax: +372 641 0174  
E-mail: amende@hot.ee  
English, Russian, Estonian

**Olga TREUFELDT****Patendibüroo TURVAJA OÜ**

Liivalaia 22  
10118 Tallinn, Estonia  
Phone: +372 640 3109  
Fax: +372 640 3105  
E-mail: turvaja@turvaja.ee  
Http://www.turvaja.ee  
English, Russian, Estonian