



EESTI VABARIIK

ISSN 1406-376X (trükiis)  
ISSN 2228-3617 (võrguväljaanne)

# T EESTI TÖÖSTUSDISAINI- LAHENDUSE LEHT



PATENDIAMETI AMETLIK VÄLJAANNE

1  
2013  
TALLINN



EESTI VABARIIK

ISSN 1406-376X (trükiis)  
ISSN 2228-3617 (võrguväljaanne)

**T**

**T** **EESTI**  
**TÖÖSTUSDISAINI-**  
**LAHENDUSE LEHT**

**PATENDIAMETI  
AMETLIK VÄLJAANNE**

**XVI aastakäik**

**Käesolevas numbris  
esitatud andmed  
loetakse avaldatuks  
15. veebruaril 2013. a.**

**1**  
**2013**  
**VEEBRUAR  
TALLINN**

Eesti Tööstusdisainilahenduse Lehte antakse välja tööstusdisaini kaitse seaduse (jõustunud 11.01.1998) alusel.  
The Estonian Industrial Design Gazette is the official publication of the Estonian Patent Office.  
Published under Industrial Design Protection Law of the Republic of Estonia (coming into force 11 January 1998).  
Date of publication of the data presented in this issue - 15 February 2013.

Patendiameti  
infoosakond  
Toompuiestee 7  
15041 Tallinn  
Tel 627 7907  
Faks 627 7943  
E-post Info@epa.ee

The Information Department  
of the Estonian Patent Office  
Toompuiestee 7  
15041 Tallinn, ESTONIA  
Phone +372 627 7907  
Fax+372 627 7943  
E-mail Info@epa.ee

Levitaja

Eesti Intellektuaalomandi ja  
Tehnoloogiasiirde Keskus  
Teaduspargi 8  
12618 Tallinn  
Tel 641 1250  
E-post patent@patentinfo.ee

Distributor

Estonian Intellectual Property and Technology  
Transfer Centre  
Teaduspargi 8  
12618 Tallinn, ESTONIA  
Phone +372 641 1250  
E-mail patent@patentinfo.ee

## SISUKORD

Andmete identifitseerimise rahvusvahelised numberkoodid (INID-koodid) . . . . .	4
Riikide, teiste ühenduste ja valitsustevaheliste organisatsioonide koodid . . . . .	5
I. REGISTREERITUD TÖÖSTUSDISAINILAHENDUSED . . . . .	6
II. RAHVUSVAHELISELT REGISTREERITUD TÖÖSTUSDISAINILAHENDUSED . . . . .	25
III. MUUD REGISTRIKANDED . . . . .	31
Registreeringu kehtivuse pikendamine . . . . .	31
Tööstusdisainilahenduse üleminek . . . . .	31
Registreeringu jagamine . . . . .	-
Registreeringu andmete muudatused . . . . .	-
Registreeringu andmete parandused . . . . .	-
Tööstusdisainilahenduse litsentsimine . . . . .	-
Tööstusdisainilahenduse pantimine . . . . .	-
Tööstusdisainilahenduse tunnistuse duplikaadi väljaandmine . . . . .	-
Registreeringu kustutamine . . . . .	31
IV. LOENDID . . . . .	32
Registreeritud tööstusdisainilahenduste registreerimise taotluste numbriline loend . . . . .	32
Rahvusvaheliselt registreeritud tööstusdisainilahenduste numbriline loend . . . . .	32
V. TÖÖSTUSDISAINIALASED ÕIGUSAKTID JA MUU INFO . . . . .	33
Riiklikus patendivolinike registris registreeritud patendivolinike nimekiri . . . . .	33

## CONTENTS

Internationally Agreed Numbers for the Identification of Data (INID Codes) . . . . .	4
List of Codes of States, Other Entities and Intergovernmental Organizations . . . . .	5
I. REGISTERED INDUSTRIAL DESIGNS . . . . .	6
II. INTERNATIONALLY REGISTERED INDUSTRIAL DESIGNS . . . . .	25
III. OTHER ENTRIES IN THE REGISTER . . . . .	31
Extension of the Registration . . . . .	31
Transfer of Industrial Design . . . . .	31
Division of the Registration. . . . .	-
Amendments to Registration Data . . . . .	-
Corrections to Registration Data . . . . .	-
Licensing of Industrial Design . . . . .	-
Pledging of Industrial Design . . . . .	-
Issue of a Copy of the Industrial Design Certificate . . . . .	-
Deletion of the Registration . . . . .	31
IV. LISTS . . . . .	32
Numerical List of Registration Applications of Registered Industrial Designs . . . . .	32
Numerical List of Internationally Registered Industrial Designs . . . . .	32
V. LEGAL ACTS AND INFORMATION CONCERNING INDUSTRIAL DESIGNS . . . . .	33
List of Patent Attorneys, Registered in the Estonian State Register of Patent Attorneys . . . . .	37

**ANDMETE IDENTIFITSEERIMISE  
RAHVUSVAHELISED NUMBERKOODID  
(INID-KOODID)  
WIPO Standard ST. 80**

**INTERNATIONALLY AGREED NUMBERS FOR  
THE IDENTIFICATION OF DATA  
(INID CODES)  
WIPO Standard ST. 80**

(11) Registreeringu number	(11) Number of the Registration
(15) Registreerimise kuupäev	(15) Date of the Registration
(18) Registreeringu kehtivuse lõppemise kuupäev	(18) Expected expiration date of the registration
(21) Registreerimistaotluse number	(21) Application Number
(22) Registreerimistaotluse esitamise kuupäev	(22) Application Filing Date
(24) Registreeringu kehtivuse alguse kuupäev	(24) Date from which the Industrial Design right has effected
(28) Variantide arv	(28) Number of Industrial Designs included in the application
(30) Prioriteet	(30) Priority
(51) Rahvusvahelise klassifikatsiooni klassi ja alaklassi number	(51) International Classification for Industrial Designs (class and subclass of the Locarno Classification)
(54) Tööstusdisainilahenduse nimetus	(54) Title of the Industrial Design
(55) Tööstusdisainilahenduse reproduktsioon	(55) Reproduction of the Industrial Design
(72) Tööstusdisainilahenduse autor(id)	(72) Author(s) of Industrial Design
(73) Tööstusdisainilahenduse omanik(ud)	(73) Proprietor(s) of Industrial Design
(74) Patendivolinik või ühine esindaja	(74) Patent Attorney or Common Representative

**RIIKIDE, TEISTE ÜHENDUSTE JA VALITSUSTEVAAHELISTE  
ORGANISATSIOONIDE KOODID**  
WIPO Standard ST. 3

AD	Andorra	EA	Euraasia Patendiorgani-	KH	Kambodža	RS	Serbia
AE	Araabia		satsioon (EAPO)	KI	Kiribati	RU	Venemaa
	Ühendemiraadid	EC	Ecuador	KM	Komoorid	RW	Rwanda
AF	Afganistan	EE	Eesti	KN	Saint Kitts ja Nevis	SA	Saudi Araabia
AG	Antigua ja Barbuda	EG	Egiptus	KP	Põhja-Korea	SB	Saalomoni Saared
AI	Anguilla	EH	Lääne-Sahara	KR	Lõuna-Korea	SC	Seišellid
AL	Albaania	EM	Siseturu Ühtlustamise	KW	Kuveit	SD	Sudaan
AM	Armeenia		Amet (kaubamärgid ja	KY	Kaimanisaared	SE	Rootsi
AO	Angola		tööstusdisainilahen-	KZ	Kasahstan	SG	Singapur
AP	Aafrika Regionaalne		dused) (OHIM)	LA	Laos	SH	Saint Helena, Ascension
	Tööstusomandi Orga-	EP	Euroopa	LB	Liibanon		ja Tristan da Cunha
	nisatsioon (ARIPO)		Patendiamet (EPO)	LC	Saint Lucia	SI	Sloveenia
AR	Argentina	ER	Eritrea	LI	Liechtenstein	SK	Slovakkia
AT	Austria	ES	Hispaania	LK	Sri Lanka	SL	Sierra Leone
AU	Austraalia	ET	Etiopia	LR	Libeeria	SM	San Marino
AW	Aruba	FI	Soome	LS	Lesotho	SN	Senegal
AZ	Aserbaidžaan	FJ	Fidži	LT	Leedu	SO	Somaalia
BA	Bosnia ja Hertsegoviina	FK	Falklandi (Malviini)	LU	Luksemburg	SR	Suriname
BB	Barbados		saared	LV	Läti	SS	Lõuna-Sudaan
BD	Bangladesh	FO	Fääri saared	LY	Liibüa	ST	São Tomé ja Príncipe
BE	Belgia	FR	Prantsusmaa	MA	Maroko	SV	El Salvador
BF	Burkina Faso	GA	Gabon	MC	Monaco	SX	Sint Maarten (Hollandi
BG	Bulgaaria	GB	Ühendkuningriik	MD	Moldova		osa)
BH	Bahrein		(Suurbritannia)	ME	Montenegro	SY	Süüria
BI	Burundi	GC	Pärsia Lahe	MG	Madagaskar	SZ	Svaasimaa
BJ	Benin		Koostöönõukogu	MK	Makedoonia	TC	Turks ja Caicos
BM	Bermuda	GD	Grenada	ML	Mali	TD	Tšaad
BN	Brunei	GE	Gruusia	MM	Myanmar (Birma)	TG	Togo
BO	Boliivia	GG	Guernsey	MN	Mongoolia	TH	Tai
BQ	Bonaire, Sint	GH	Ghana	MO	Macao	TJ	Tadžikistan
	Eustatius ja Saba	GI	Gibraltar	MP	Põhja-Mariaanid	TL	Ida-Timor
BR	Brasiilia	GL	Gröönimaa	MR	Mauritaania	TM	Türkmenistan
BS	Bahama	GM	Gambia	MS	Montserrat	TN	Tuneesia
BT	Bhutan	GN	Guinea	MT	Malta	TO	Tonga
BV	Bouvet' saar	GQ	Ekvatoriaal-Guinea	MU	Mauritius	TR	Türgi
BW	Botswana	GR	Kreeka	MV	Maldiivid	TT	Trinidad ja Tobago
BX	Beneluxi Kaubamärgi-	GS	Lõuna-Georgia ja	MW	Malawi	TV	Tuvalu
	amet (BBM) ja Beneluxi		Lõuna-Sandwichi	MX	Mehhiko	TW	Taiwan (Hiina provints)
	Tööstusdisainilahendus-		saared	MY	Malaisia	TZ	Tansaania
	te Amet (BBDM)	GT	Guatemala	MZ	Mosambiik	UA	Ukraina
BY	Valgevene	GW	Guinea-Bissau	NA	Namiibia	UG	Uganda
BZ	Belize	GY	Guyana	NE	Niger	US	Ameerika
CA	Kanada	HK	Hongkong	NG	Nigeeria		Ühendriigid
CD	Kongo Demokraatlik	HN	Honduras	NI	Nicaragua	UY	Uruguay
	Vabariik	HR	Horvaatia	NL	Holland	UZ	Usbekistan
CF	Kesk-Aafrika Vabariik	HT	Haiti	NO	Norra	VA	Vatikan (Püha Tool)
CG	Kongo	HU	Ungari	NP	Nepal	VC	Saint Vincent ja
CH	Šveits	IB	Maailma	NR	Nauru		Grenadiinid
CI	Côte d'Ivoire		Intellektuaalomandi	NZ	Uus-Meremaa	VE	Venezuela
CK	Cooki saared		Organisatsiooni (WIPO)	OA	Aafrika Intellektuaal-	VG	Neitsisaared
CL	Tšiili		Rahvusvaheline Büroo		omandi Organisatsioon	VN	Vietnam
CM	Kamerun	ID	Indoneesia		(OAPI)	VU	Vanuatu
CN	Hiina	IE	Iiri	OM	Omaan	WO	Maailma
CO	Kolumbia	IL	Iisrael	PA	Panama		Intellektuaalomandi
CR	Costa Rica	IM	Man'i saar	PE	Peruu		Organisatsioon (WIPO)
CU	Kuuba	IN	India	PG	Paapua Uus-Guinea		(Rahvusvaheline Büroo)
CV	Cabo Verde	IQ	Iraak	PH	Filipiinid	WS	Samoa
CW	Curaçao	IR	Iraan	PK	Pakistan	XN	Põhjamaade
CY	Küpros	IS	Island	PL	Poola		Patendiinstituut (PPI)
CZ	Tšehhi	IT	Itaalia	PT	Portugal	YE	Jeemen
DE	Saksamaa	JE	Jersey	PW	Belau	ZA	Lõuna-Aafrika Vabariik
DJ	Djibouti	JM	Jamaica	PY	Paraguay	ZM	Sambia
DK	Taani	JO	Jordaania	QA	Katar	ZW	Zimbabwe
DM	Dominica	JP	Jaapan	QZ	Ühenduse Sordiamet		
DO	Dominikaani Vabariik	KE	Kenya		(Euroopa Liit) (EÜSA)		
DZ	Alžeeria	KG	Kõrgõzstan	RO	Rumeenia		

## **I. REGISTREERITUD TÖÖSTUSDISAINILAHENDUSED**

Avaldatakse "Tööstusdisaini kaitse seaduse" § 55<sup>1</sup> lõike 7 alusel.

Patendiamet ei ole kontrollinud tööstusdisainilahenduse uudsust ja eristatavust tulenevalt "Tööstusdisaini kaitse seaduse" § 31 lõike 2 punktist 1.

(11) Registreeringu number	<b>01770</b>	
(21) Taotluse number	D201200032	(51) Klass: <b>26-01</b>
(15) Registreerimise päev	15.02.2013	
(22) Esitamise päev	25.04.2012	
(24) Registreeringu kehtivuse alguse päev	25.04.2012	
(18) Registreeringu kehtivuse lõppemise päev	25.04.2017	
(28) Variantide arv	2	
(72) Autor	Helmet Raja, Salme 49-4, 10413 Tallinn, EE	
(73) Omanik	Helmet Raja, Salme 49-4, 10413 Tallinn, EE	
(74) Patendivolinik või ühine esindaja	Ott Moorlat	

(54) Nimetus **Küünlajalg**

(55) Reproduktsoon

01770-1

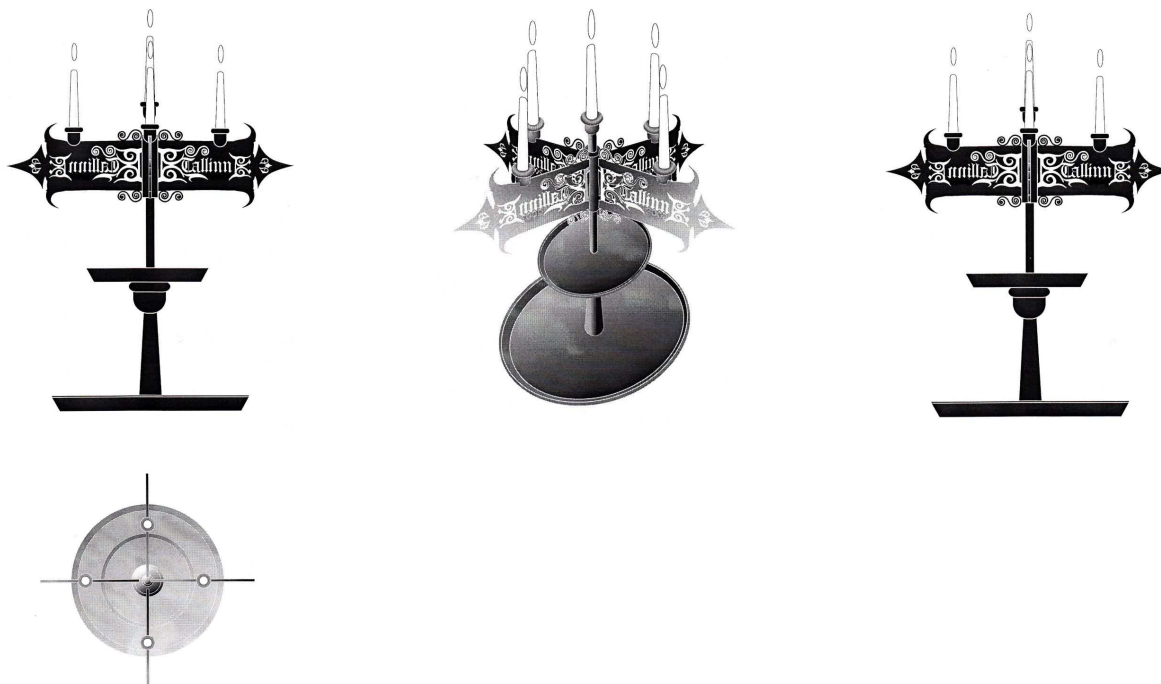

01770-2

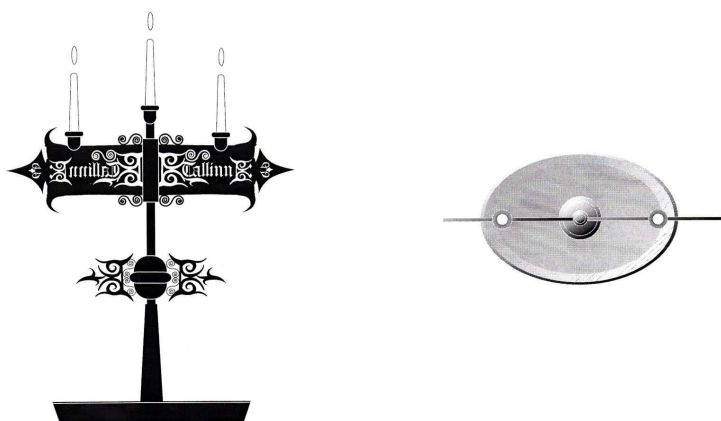



(11) Registreeringu number	<b>01771</b>	(51) Klass: <b>09-01</b>
(21) Taotluse number	D201200064	
(15) Registreerimise päev	15.02.2013	
(22) Esitamise päev	20.09.2012	
(24) Registreeringu kehtivuse alguse päev	20.09.2012	
(18) Registreeringu kehtivuse lõppemise päev	20.09.2017	
(28) Variantide arv	2	
(72) Autor	Evelin Jõgeda, Tähe 98-26, 50107 Tartu, EE	
(73) Omanik	Evelin Jõgeda, Tähe 98-26, 50107 Tartu, EE	

(54) Nimetus **Mahlapudel**

(55) Reproduktsoon

01771-1



01771-2



(11) Registreeringu number	01772	(51) Klass: 09-03
(21) Taotluse number	D201200065	
(15) Registreerimise päev	15.02.2013	
(22) Esitamise päev	20.09.2012	
(24) Registreeringu kehtivuse alguse päev	20.09.2012	
(18) Registreeringu kehtivuse lõppemise päev	20.09.2017	
(28) Variantide arv	1	
(72) Autor	Evelin Jõgeda, Tähe 98-26, 50107 Tartu, EE	
(73) Omanik	Evelin Jõgeda, Tähe 98-26, 50107 Tartu, EE	

(54) Nimetus **Pakend**

(55) Reproduktsoon

01772-1



(11) Registreeringu number	<b>01773</b>
(21) Taotluse number	D201200066
(15) Registreerimise päev	15.02.2013
(22) Esitamise päev	21.09.2012
(24) Registreeringu kehtivuse alguse päev	21.09.2012
(18) Registreeringu kehtivuse lõppemise päev	21.09.2017
(28) Variantide arv	2
(72) Autor	Evelin Jõgeda, Tähe 98-26, 50107 Tartu, EE
(73) Omanik	Evelin Jõgeda, Tähe 98-26, 50107 Tartu, EE

(51) Klass: **09-01**(54) Nimetus **Mahlapudel**

(55) Reproduktsoon

01773-1



01773-2



(11) Registreeringu number	<b>01774</b>	(51) Klass: <b>09-01</b>
(21) Taotluse number	D201200067	
(15) Registreerimise päev	15.02.2013	
(22) Esitamise päev	21.09.2012	
(24) Registreeringu kehtivuse alguse päev	21.09.2012	
(18) Registreeringu kehtivuse lõppemise päev	21.09.2017	
(28) Variantide arv	2	
(72) Autor	Evelin Jõgeda, Tähe 98-26, 50107 Tartu, EE	
(73) Omanik	Evelin Jõgeda, Tähe 98-26, 50107 Tartu, EE	

(54) Nimetus **Mahlapudel**

(55) Reproduktsoon

01774-1



01774-2



(11) Registreeringu number	<b>01775</b>	(51) Klass: <b>09-01</b>
(21) Taotluse number	D201200068	
(15) Registreerimise päev	15.02.2013	
(22) Esitamise päev	21.09.2012	
(24) Registreeringu kehtivuse alguse päev	21.09.2012	
(18) Registreeringu kehtivuse lõppemise päev	21.09.2017	
(28) Variantide arv	2	
(72) Autor	Evelin Jõgeda, Tähe 98-26, 50107 Tartu, EE	
(73) Omanik	Evelin Jõgeda, Tähe 98-26, 50107 Tartu, EE	

(54) Nimetus **Mahlapudel**

(55) Reproduktsoon

01775-1



01775-2



(11) Registreeringu number	<b>01776</b>
(21) Taotluse number	D201200069
(15) Registreerimise päev	15.02.2013
(22) Esitamise päev	21.09.2012
(24) Registreeringu kehtivuse alguse päev	21.09.2012
(18) Registreeringu kehtivuse lõppemise päev	21.09.2017
(28) Variantide arv	1
(72) Autor	Evelin Jõgeda, Tähe 98-26, 50107 Tartu, EE
(73) Omanik	Evelin Jõgeda, Tähe 98-26, 50107 Tartu, EE

(51) Klass: **09-01**(54) Nimetus **Mahlapudel**

(55) Reproduktsoon

01776-1



(11) Registreeringu number	01777
(21) Taotluse number	D201200069A
(15) Registreerimise päev	15.02.2013
(22) Esitamise päev	21.09.2012
(24) Registreeringu kehtivuse alguse päev	21.09.2012
(18) Registreeringu kehtivuse lõppemise päev	21.09.2017
(28) Variantide arv	1
(72) Autor	Evelin Jõgeda, Tähe 98-26, 50107 Tartu, EE
(73) Omanik	Evelin Jõgeda, Tähe 98-26, 50107 Tartu, EE

(51) Klass: 09-03

(54) Nimetus **Pakend**

(55) Reproduktsoon

01777-1



(11) Registreeringu number	<b>01778</b>	(51) Klass: <b>25-02</b>
(21) Taotluse number	D201200070	
(15) Registreerimise päev	15.02.2013	
(22) Esitamise päev	01.10.2012	
(24) Registreeringu kehtivuse alguse päev	01.10.2012	
(18) Registreeringu kehtivuse lõppemise päev	01.10.2017	
(28) Variantide arv	4	
(72) Autor	Elmet Treier, Suur-Aia 61-45, Paide, 72719 Järva maakond, EE Erik Kuningas, Tulika 40-6, 10613 Tallinn, EE	
(73) Omanik	Z-Module OÜ, Peedu küla, Albu vald, 73413 Järva maakond, EE	
(74) Patendivolinik või ühine esindaja	Lembit Kalev	

(54) Nimetus **Ehitusdetail**

(55) Reproduktsoon

01778-1

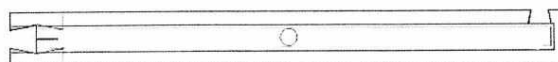
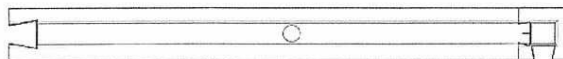
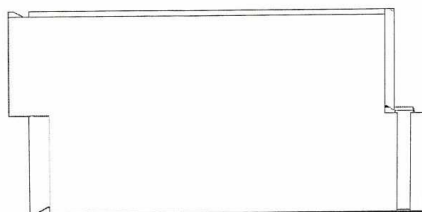
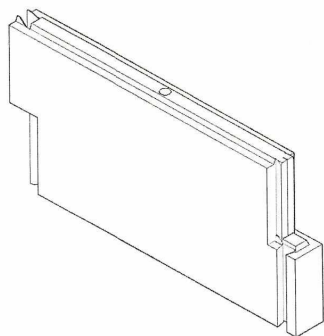



01778-2

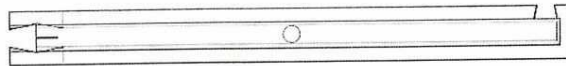
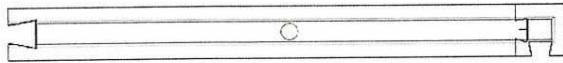
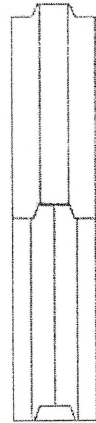
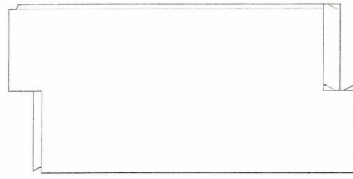
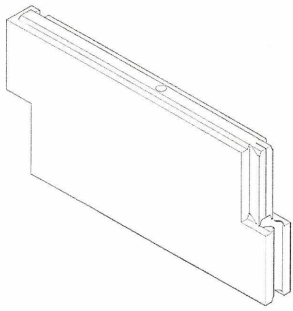

---

01778-3

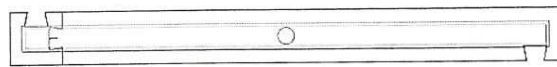
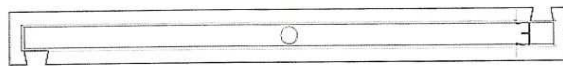
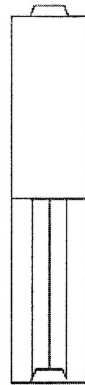
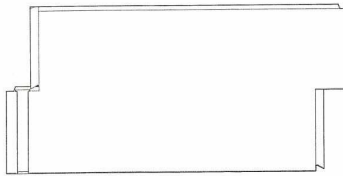
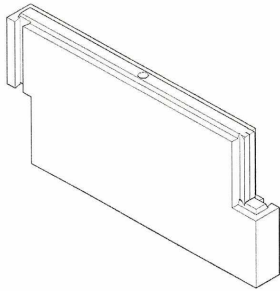

01778-4

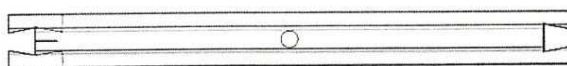
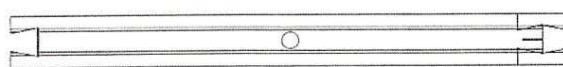
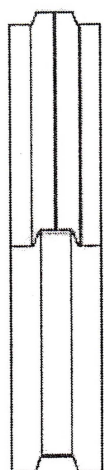
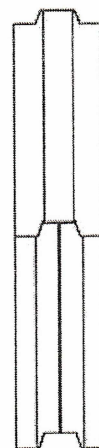
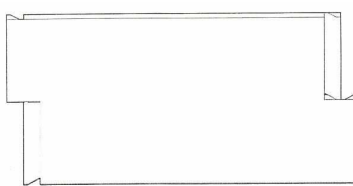
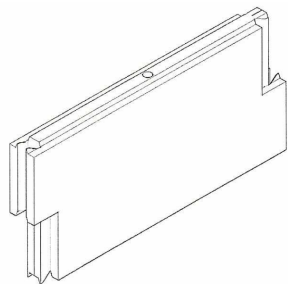

(11) Registreeringu number	<b>01779</b>	(51) Klass: <b>25-02</b>
(21) Taotluse number	D201200070A	
(15) Registreerimise päev	15.02.2013	
(22) Esitamise päev	01.10.2012	
(24) Registreeringu kehtivuse alguse päev	01.10.2012	
(18) Registreeringu kehtivuse lõppemise päev	01.10.2017	
(28) Variantide arv	1	
(72) Autor	Elmet Treier, Suur-Aia 61-45, Paide, 72719 Järva maakond, EE Erik Kuningas, Tulika 40-6, 10613 Tallinn, EE	
(73) Omanik	Z-Module OÜ, Peedu küla, Albu vald, 73413 Järva maakond, EE	
(74) Patendivolinik või ühine esindaja	Lembit Kalev	

(54) Nimetus **Ehitusdetail**

(55) Reproduktsoon

01779-1

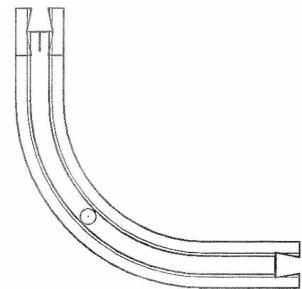
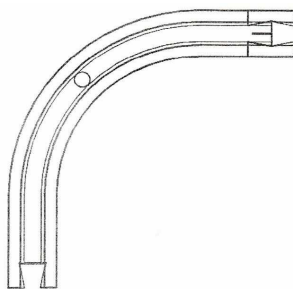
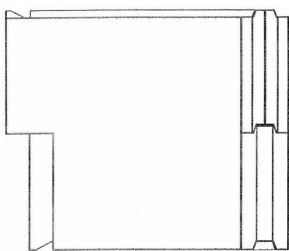
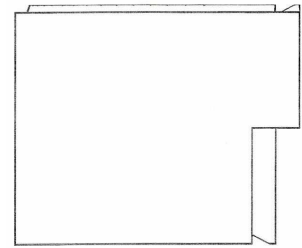
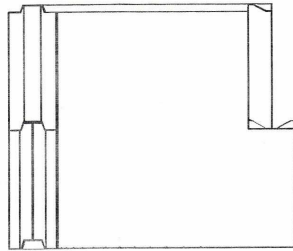
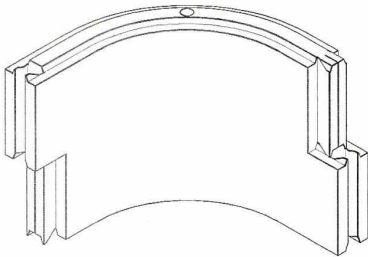

(11) Registreeringu number	<b>01780</b>	(51) Klass: <b>11-02</b>
(21) Taotluse number	D201200078	
(15) Registreerimise päev	15.02.2013	
(22) Esitamise päev	18.10.2012	
(24) Registreeringu kehtivuse alguse päev	18.10.2012	
(18) Registreeringu kehtivuse lõppemise päev	18.10.2017	
(28) Variantide arv	2	
(72) Autor	Margo Metste, Ehituse 6-39, Jüri, 75301 Jüri, Harju maakond, EE	
(73) Omanik	Margo Metste, Ehituse 6-39, Jüri, 75301 Harju maakond, EE	

(54) Nimetus **Vaas**

(55) Reproduktsoon

01780-1

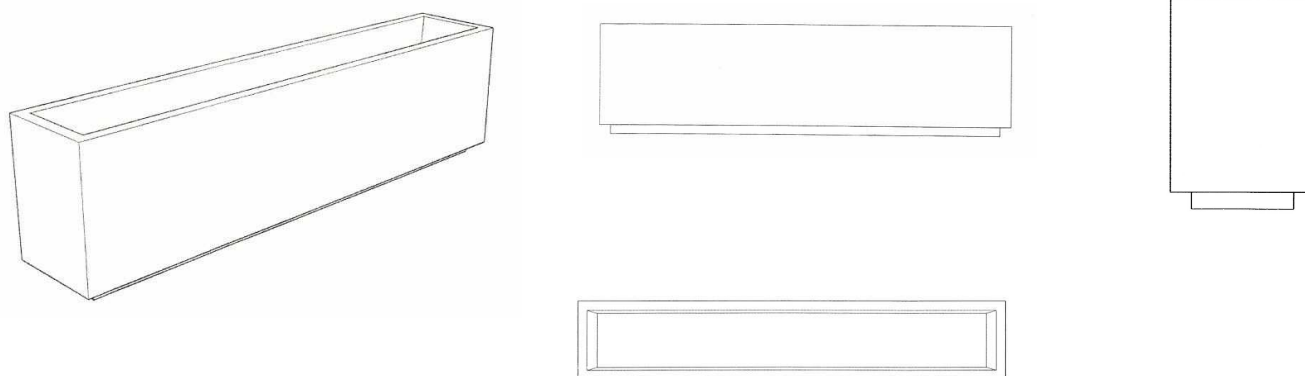

01780-2

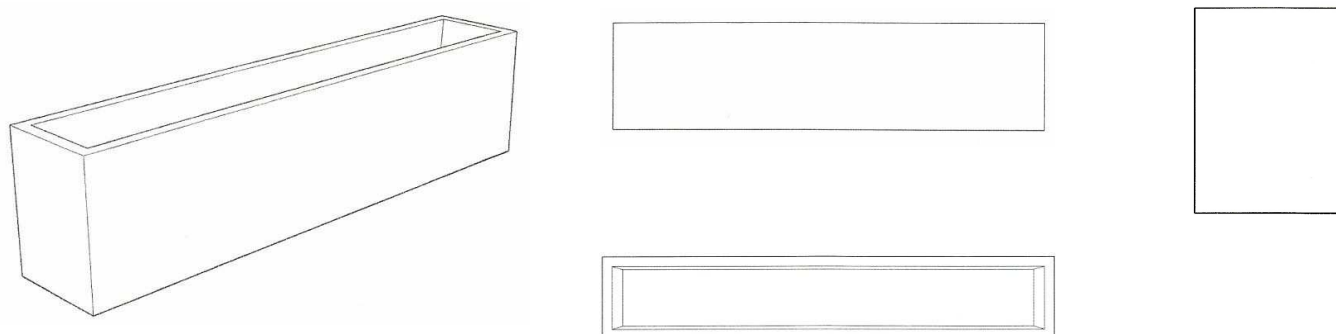

(11) **Registreeringu number** **01781**

(51) Klass: **25-03**

(21) **Taotluse number** D201200079

(15) **Registreerimise päev** 15.02.2013

(22) **Esitamise päev** 18.10.2012

(24) **Registreeringu kehtivuse alguse päev** 18.10.2012

(18) **Registreeringu kehtivuse lõppemise päev** 18.10.2017

(28) **Variantide arv** 1

(72) **Autor** Raul Uibopuu, Pärna 11, Otepää, 67404 Valga maakond, EE

(73) **Omanik** Raul Uibopuu, Pärna 11, Otepää, 67404 Valga maakond, EE

(54) **Nimetus** **Tünnisaun**

(55) **Reproduktsoon**

01781-1

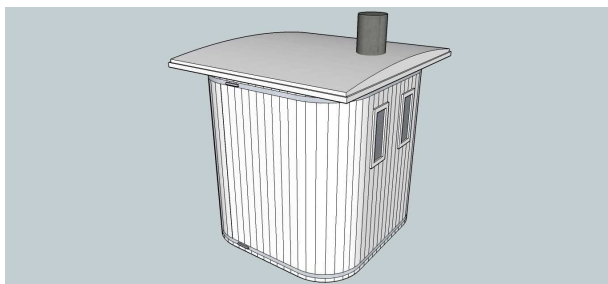
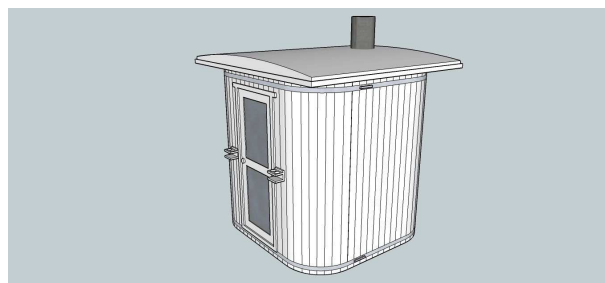
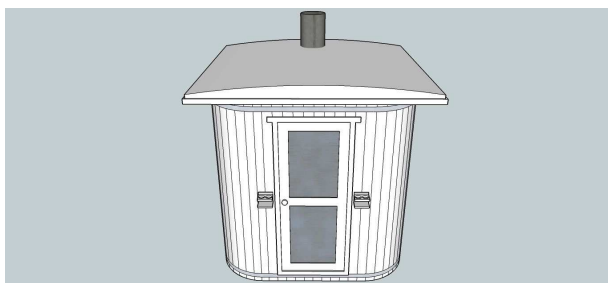

(11) **Registreeringu number** **01782**

(51) **Klass:** 25-03

(21) **Taotluse number** D201200080

(15) **Registreerimise päev** 15.02.2013

(22) **Esitamise päev** 19.10.2012

(24) **Registreeringu kehtivuse alguse päev** 19.10.2012

(18) **Registreeringu kehtivuse lõppemise päev** 19.10.2017

(28) **Variantide arv** 1

(72) **Autor** Raul Uibopuu, Pärna 11, Otepää, 67404 Valga maakond, EE

(73) **Omanik** Raul Uibopuu, Pärna 11, Otepää, 67404 Valga maakond, EE

(54) **Nimetus** **Freesprussidest kokku pandav suvemaja/saun**

(55) **Reproduktsoon**

01782-1



- (11) **Registreeringu number** **01783** (51) Klass: **26-05**
- (21) **Taotluse number** D201200081
- (15) **Registreerimise päev** 15.02.2013
- (22) **Esitamise päev** 30.10.2012
- (24) **Registreeringu kehtivuse alguse päev** 30.10.2012
- (18) **Registreeringu kehtivuse lõppemise päev** 30.10.2017
- (28) **Variantide arv** 1
- (72) **Autor** Triin Kõivupuu, Kesk Kaar 37-4, 50404 Tartu, EE
- (73) **Omanik** Triin Kõivupuu, Kesk Kaar 37-4, 50404 Tartu, EE
- (54) **Nimetus** **Vineerist või spoonist valgusti "Pegasus"**
- (55) **Reproduktsoon**
- 01783-1



- (11) **Registreeringu number** **01784** (51) Klass: **16-99**
- (21) **Taotluse number** D201200083
- (15) **Registreerimise päev** 15.02.2013
- (22) **Esitamise päev** 16.11.2012
- (24) **Registreeringu kehtivuse alguse päev** 16.11.2012
- (18) **Registreeringu kehtivuse lõppemise päev** 16.11.2017
- (28) **Variantide arv** 1
- (72) **Autor** Aivo Jenk, Valukoja 7, 11415 Tallinn, EE  
Arnold Vill, Valukoja 7, 11415 Tallinn, EE  
Leino Vint, Valukoja 7, 11415 Tallinn, EE
- (73) **Omanik** Nemor Technologies OÜ, Valukoja 7, 11415 Tallinn, EE
- (74) **Patendivolinik või ühine esindaja** Ott Moorlat
- (54) **Nimetus** **Laser**
- (55) **Reproduktsoon**

01784-1

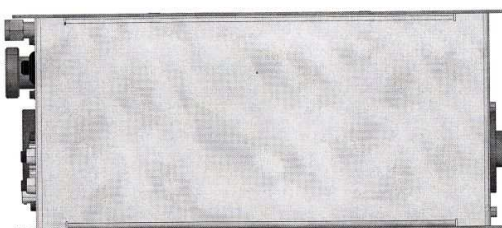
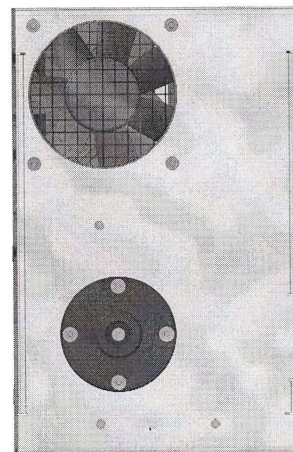
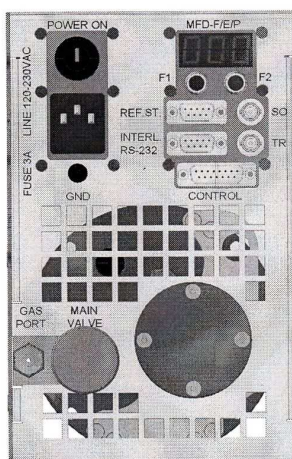



(11) Registreeringu number	<b>01785</b>
(21) Taotluse number	D201200085
(15) Registreerimise päev	15.02.2013
(22) Esitamise päev	29.11.2012
(24) Registreeringu kehtivuse alguse päev	29.11.2012
(18) Registreeringu kehtivuse lõppemise päev	29.11.2017
(28) Variantide arv	1
(72) Autor	Mari Ojasaar, Koidu 40-8, 10136 Tallinn, EE
(73) Omanik	Mari Ojasaar, Koidu 40-8, 10136 Tallinn, EE

(51) Klass: **03-01**(54) Nimetus **Raamatkott**

(55) Reproduktsoon

01785-1

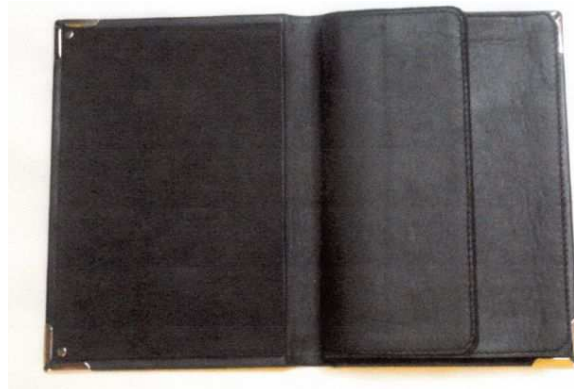

## **II. RAHVUSVAHELISELT REGISTREERITUD TÖÖSTUSDISAINILAHENDUSED**

Avaldatakse "Tööstusdisaini kaitse seaduse" § 87<sup>4</sup> lõike 3 alusel.

Patendiamet ei ole kontrollinud tööstusdisainilahenduse uudsust ja eristatavust tulenevalt "Tööstusdisaini kaitse seaduse" § 31 lõike 2 punktist 1.

(11) **Rahvusvah reg nr**

**DM/077911**

(51) Klass: **02-06**

(21) **Rahvusvah reg jrk**

H201200005

(15) **Registreeringu päev**

09.11.2011

(28) **Variantide arv**

1

(72) **Autor**

Marthon Granberg

(73) **Omanik**

Granberg AS, Innbjøa, N-5584 Bjøa, NO

**WIPO Rahvusvah Tööstusdisainilahenduste**

**Bülletääni nr, kus registreering on avaldatud** 18/2012

(55) **Reproduksioon**

DM/077911-1



(11) **Rahvusvah reg nr**

**DM/078098**

(51) Klass: **02-02**

(21) **Rahvusvah reg jrk**

H201200004

(15) **Registreeringu päev**

15.02.2012

(28) **Variantide arv**

1

(72) **Autor**

*Autori andmeid ei avalikustata*

(73) **Omanik**

MONCLER S.R.L., Via Stendhal, 47, I-20144 Milano, IT

**WIPO Rahvusvah Tööstusdisainilahenduste**

**Bülletääni nr, kus registreering on avaldatud** 16/2012

(55) **Reproduktsoon**

DM/078098-1

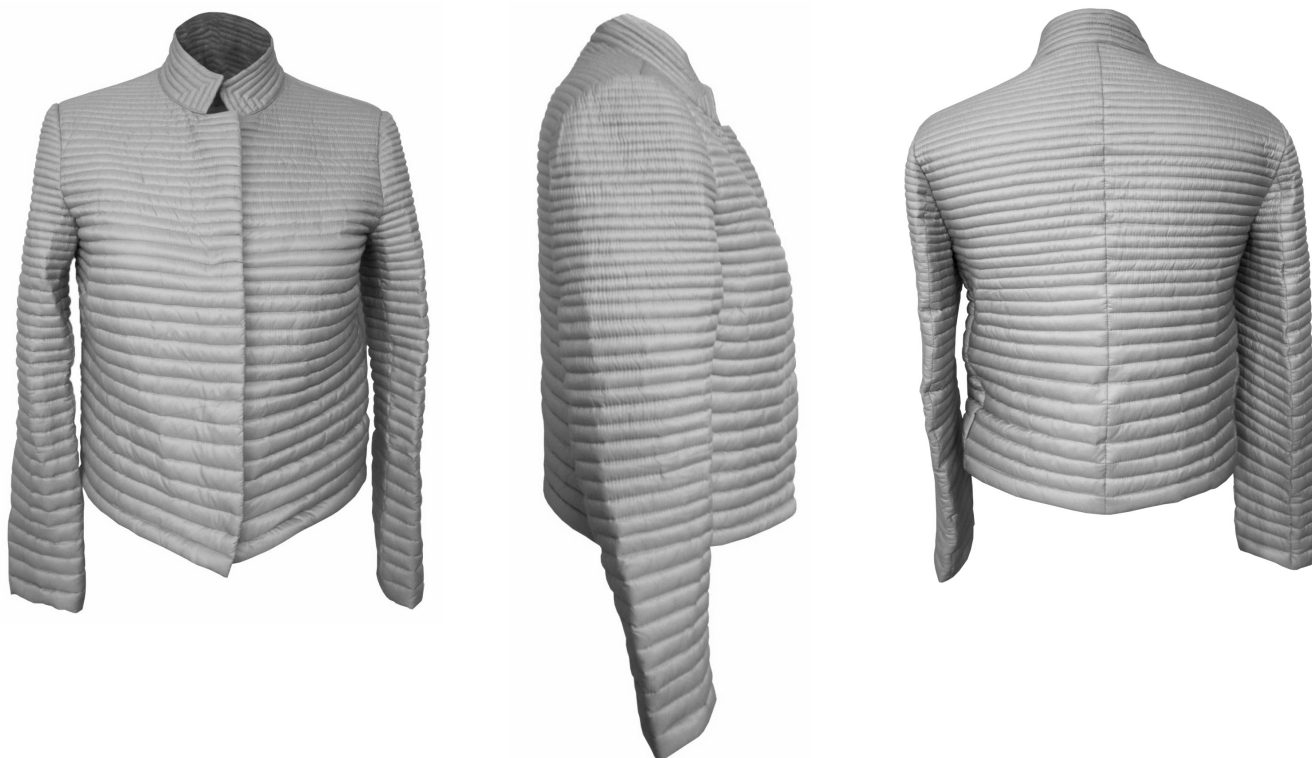

(11) **Rahvusvah reg nr**

DM/079277

(51) Klass: **26-06**(21) **Rahvusvah reg jrk**

H201200012

(15) **Registreeringu päev**

11.10.2012

(22) **Esitamise päev**

11.07.2012

(28) **Variantide arv**

2

(72) **Autor**

Frank Pichat

(73) **Omanik**

VIGNAL SYSTEMS, 12 rue Eugène Henaff, F-69200 VENISSIEUX, FR

**WIPO Rahvusvah Tööstusdisainilahenduste****Bülletääni nr, kus registreering on avaldatud** 42/2012(55) **Reproduktsoon**

DM/079277-1



DM/079277-2



(11) **Rahvusvah reg nr**

**DM/079298**

(51) Klass: **08-06**

(21) **Rahvusvah reg jrk**

H201200017

(15) **Registreeringu päev**

02.07.2012

(28) **Variantide arv**

2

(72) **Autor**

Antony Villain

(73) **Omanik**

Renault S.A.S., 13/15, quai Alphonse le Gallo,  
F-92100 Boulogne-Billancourt, FR

**WIPO Rahvusvah Tööstusdisainilahenduste  
Bülletääni nr, kus registreering on avaldatud**

42/2012

(55) **Reproduksioon**

DM/079298-1

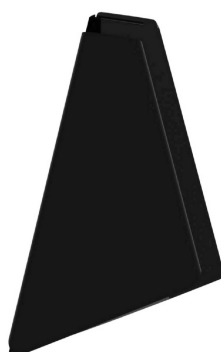

DM/079298-2

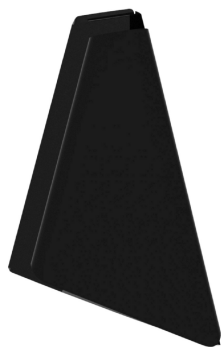

**III. MUUD REGISTRIKANDED****REGISTREERINGU KEHTIVUSE PIKENDAMINE**

Reg nr	Registreeringu pikendatud kehtivusaja lõppemise päev
--------	--

00209	11.01.2018
00775	31.01.2018
00778	14.01.2018
01412	15.01.2018

**TÖÖSTUSDISAINILAHENDUSE ÜLEMINEK**

Reg nr	Uue omaniku andmed	Registrikande jõustumise päev
00863	Tarplani Kaubanduse OÜ, Rannamõisa tee 10, Tabasalu, 76901 Harju maakond, EE	23.01.2013

**REGISTREERINGU KUSTUTAMINE**

"Tööstusdisaini kaitse seaduse" paragrahvi 77 lõike 1 alusel on registrist kustutatud järgmised tööstusdisainilahendused:

Reg nr	Kustutamise kande jõustumise päev
--------	-----------------------------------

00631	12.04.2012	00664	18.07.2012	01326	03.04.2012	01345	11.07.2012
00633	07.05.2012	00665	27.05.2012	01327	13.04.2012	01346	11.07.2012
00635	14.05.2012	00668	19.07.2012	01328	30.04.2012	01347	11.07.2012
00637	17.05.2012	00672	12.04.2012	01329	11.05.2012	01348	11.07.2012
00641	13.05.2012	00674	07.05.2012	01332	13.04.2012	01360	11.04.2012
00645	27.05.2012	00676	22.07.2012	01333	18.04.2012	01361	11.04.2012
00647	10.06.2012	00677	26.07.2012	01334	18.04.2012	01362	11.04.2012
00649	12.06.2012	00678	26.07.2012	01335	14.05.2012	01364	25.07.2012
00655	18.07.2012	00679	26.07.2012	01336	14.05.2012	01365	26.07.2012
00656	18.07.2012	00680	26.07.2012	01337	28.05.2012	01386	28.05.2012
00657	18.07.2012	00681	26.07.2012	01338	28.05.2012	01387	27.07.2012
00658	18.07.2012	00684	29.07.2012	01339	28.05.2012	01439	22.05.2012
00659	18.07.2012	00685	18.07.2012	01340	28.05.2012	01440	28.05.2012
00660	18.07.2012	00705	22.07.2012	01341	28.05.2012	01441	28.05.2012
00661	18.07.2012	00718	03.07.2012	01342	28.05.2012	01442	28.05.2012
00662	18.07.2012	00723	22.07.2012	01343	18.06.2012	01443	13.07.2012
00663	18.07.2012	01325	27.03.2012	01344	11.07.2012		



## IV. LOENDID

REGISTREERITUD TÖÖSTUSDISAINILAHENDUSTE REGISTREERIMISE TAOTLUSTE  
NUMBRILINE LOEND

Registreerimis- taotluse number	Registreeringu number
------------------------------------	--------------------------

D201200032	01770	D201200070	01778
D201200064	01771	D201200070A	01779
D201200065	01772	D201200078	01780
D201200066	01773	D201200079	01781
D201200067	01774	D201200080	01782
D201200068	01775	D201200081	01783
D201200069	01776	D201200083	01784
D201200069A	01777	D201200085	01785

RAHVUSVAHELISELT REGISTREERITUD TÖÖSTUSDISAINILAHENDUSTE  
NUMBRILINE LOEND

Rahvusvah reg jrk	Rahvusvah reg nr
-------------------	------------------

H201200004	DM/078098
H201200005	DM/077911
H201200012	DM/079277
H201200017	DM/079298

## V. TÖÖSTUSDISAINIALASED ÕIGUSAKTID JA MUU INFO

RIIKLIKUS PATENDIVOLINIKE REGISTRIS REGISTREERITUD PATENDIVOLINIKE NIMEKIRI  
(seisuga 4. jaanuar 2013)

Register on asutatud 1. septembril 2001. a Vabariigi Valitsuse 7. augusti 2001. a määrusega nr 271 "Riikliku patendivolinike registri asutamine ja registri pidamise põhimäärus" (RT I 2001, 70, 426) patendivoliniku seaduse § 21 alusel (RT I 2001, 27, 151).

## TEGEVUSVALDKOND: KAUBAMÄRK, TÖÖSTUSDISAINILAHENDUS JA GEOGRAAFILINE TÄHIS

<b>Arno ANIJALG</b>	<b>Patendibüroo Ustervall OÜ</b> Kivi 21-6 51009 Tartu telefon: 744 1980 telefaks: 744 1785 e-post: anijalg@ustervall.ee http://www.ustervall.ee võõrkeeled: saksa, vene	<b>Juhan HÄMMALOV</b>	<b>INTELS Patendibüroo OÜ</b> Magasini 12 51005 Tartu telefon: 742 0401 telefaks: 742 0326 e-post: intels@intels.ee http://www.intels.ee võõrkeeled: inglise, saksa, vene
<b>Aivo ARULA</b>	<b>Patendibüroo Käosaar &amp; Co OÜ</b> Tähe 94 50107 Tartu telefon: 738 3051 telefaks: 738 3055 e-post: info@kaosaar.ee http://www.kaosaar.ee võõrkeeled: inglise, vene	<b>Martin JÕGI</b>	<b>LASVET Patendibüroo OÜ</b> Suurtüki 4a, 10133 Tallinn telefon: 640 6600 telefaks: 640 6604 e-post: lasvet@lasvet.ee http://www.lasvet.ee võõrkeeled: soome, vene, inglise
<b>Martina BÖCKLER-LORVI</b>	<b>LASVET Patendibüroo OÜ</b> Suurtüki 4a, 10133 Tallinn pk 3136, 10505 Tallinn telefon: 640 6600 telefaks: 640 6604 e-post: lasvet@lasvet.ee http://www.lasvet.ee võõrkeeled: inglise, soome	<b>Uno JÄÄGER</b>	<b>Inseneribüroo Uneko OÜ</b> Rüütli 51a, 80010 Pärnu telefon: 447 1021 telefaks: 447 1001 GSM: 515 1844 e-post: info@uneko.ee http://www.uneko.ee võõrkeeled: inglise, soome, vene
<b>Indrek EELMETS</b>	<b>Advokaadibüroo SORAINEN AS</b> Pärnu mnt 15 10141 Tallinn telefon: 640 0900 telefaks: 640 0901 e-post: estonia@sorainen.com http://www.sorainen.com võõrkeeled: inglise, vene, soome	<b>Sirje KAHU</b>	<b>Patendibüroo Ustervall OÜ</b> Kivi 21-6 51009 Tartu telefon: 744 1980 telefaks: 744 1785 e-post: skahu@ustervall.ee http://www.ustervall.ee võõrkeeled: inglise, vene
<b>Alla HÄMMALOV</b>	<b>INTELS Patendibüroo OÜ</b> Magasini 12 51005 Tartu telefon: 742 0401 telefaks: 742 0326 e-post: intels@intels.ee http://www.intels.ee võõrkeeled: inglise, poola, vene	<b>Lembit KALEV</b>	<b>Patendibüroo ROOSILLA OÜ</b> Järveotsa tee 39-61 13520 Tallinn telefon: 657 1722, 657 5381 telefaks: 657 5381 GSM: 511 9951 e-post: roosilla@roosilla.ee http://www.roosilla.ee võõrkeeled: inglise, vene

- Anneli KANG** **OÜ Synest**  
pk 977, 13402 Tallinn  
telefon: 660 9786  
telefaks: 660 9787  
e-post: anneli@synest.ee  
võõrkeeled: inglise, saksa, vene,  
prantsuse, soome, rootsi
- Anneli KAPP** **Patendibüroo Käosaar & Co OÜ**  
Tähe 94  
50107 Tartu  
telefon: 738 3051  
telefaks: 738 3055  
e-post: info@kaosaar.ee  
http://www.kaosaar.ee  
võõrkeeled: inglise, vene
- Urmas KAULER** **Patendibüroo TURVAJA OÜ**  
Liivalaia 22  
10118 Tallinn  
telefon: 640 3109  
telefaks: 640 3105  
e-post: turvaja@turvaja.ee  
http://www.turvaja.ee  
võõrkeeled: inglise, vene, soome
- Urmas KERNU** **AAA Patendibüroo OÜ**  
Tartu mnt 16  
10117 Tallinn  
pk 3926, 10509 Tallinn  
telefon: 660 5910, 660 5911  
telefaks: 660 5912  
e-post: aaa@aaa.ee  
http://www.aaa.ee  
võõrkeeled: inglise, saksa,  
soome, vene
- Ljubov KESSELMAN** **OÜ Kesna**  
Tedre 77-52  
10616 Tallinn  
telefon: 660 8068  
telefaks: 660 8069  
e-post: kesna@kesna.ee  
http://www.kesna.ee  
võõrkeeled: inglise, vene
- Marina KESSELMAN** **OÜ Kesna**  
Tedre 77-52  
10616 Tallinn  
telefon: 660 8068  
telefaks: 660 8069  
e-post: kesna@kesna.ee  
http://www.kesna.ee  
võõrkeeled: inglise, saksa, vene
- Raivo KOITEL**
- Patendi- & Kaubamärgibüroo Koitel OÜ**  
Tartu mnt 65  
10115 Tallinn  
pk 1759, 10902 Tallinn  
telefon: 603 3260  
telefaks: 603 3261  
e-post: koitel@koitel.ee  
http://www.koitel.ee  
võõrkeeled: inglise, soome, vene
- Katrin KOITEL-VEIDIK**
- Patendi- & Kaubamärgibüroo Koitel OÜ**  
Tartu mnt 65  
10115 Tallinn  
pk 1759, 10902 Tallinn  
telefon: 603 3260  
telefaks: 603 3261  
e-post: koitel@koitel.ee  
http://www.koitel.ee  
võõrkeeled: inglise, soome
- Mart Enn KOPPEL** **KOPPEL patendibüroo OÜ**  
Roseni 10-151  
10111 Tallinn  
telefon: 677 4136  
telefaks: 677 4138  
e-post: info@koppelpb.com  
http://www.koppelpb.com  
võõrkeeled: inglise, vene, soome
- Anna KOSAR** **Patendi- & Kaubamärgibüroo Koitel OÜ**  
Tartu mnt 65  
10115 Tallinn  
pk 1759, 10902 Tallinn  
telefon: 603 3260  
telefaks: 603 3261  
e-post: koitel@koitel.ee  
http://www.koitel.ee  
võõrkeeled: inglise, vene
- Heinrich KRUPP** **Patendibüroo TURVAJA OÜ**  
Liivalaia 22  
10118 Tallinn  
telefon: 640 3109  
telefaks: 640 3105  
e-post: turvaja@turvaja.ee  
http://www.turvaja.ee  
võõrkeeled: saksa, vene
- Jüri KÄOSAAR** **Patendibüroo Käosaar & Co OÜ**  
Tähe 94  
50107 Tartu  
telefon: 738 3051  
telefaks: 738 3055  
e-post: info@kaosaar.ee  
http://www.kaosaar.ee  
võõrkeeled: inglise, vene

<b>Kalev KÄOSAAR</b>	<b>Patendibüroo Käosaar &amp; Co OÜ</b> Suur-Patarei 2 10415 Tallinn telefon: 637 9484 telefaks: 637 9485 e-post: kalev.kaosaar@kaosaar.ee http://www.kaosaar.ee võõrkeeled: inglise, vene	<b>Lembit MITT</b>	<b>AAA Patendibüroo OÜ</b> Tartu mnt 16, 10117 Tallinn pk 3926, 10509 Tallinn telefon: 660 5910, 660 5911 telefaks: 660 5912 e-post: aaa@aaa.ee http://www.aaa.ee võõrkeeled: inglise, vene
<b>Kärt LAIGU</b>	kutsetegevus on peatatud	<b>Ott MOORLAT</b>	<b>OÜ Moorlat &amp; Ko Patendibüroo</b> pk 4730, 13503 Tallinn telefon: 648 2085 telefaks: 654 2844 e-post: ott.moorlat@moorlat.ee http://www.moorlat.ee võõrkeeled: inglise, vene
<b>Kristjan LEPPIK</b>	<b>Patendibüroo TURVAJA OÜ</b> Liivalaia 22 10118 Tallinn telefon: 640 3109 telefaks: 640 3105 e-post: turvaja@turvaja.ee http://www.turvaja.ee võõrkeeled: inglise, vene	<b>Anfia MORNA</b>	<b>Patendibüroo TURVAJA OÜ</b> Liivalaia 22, 10118 Tallinn telefon: 640 3109 telefaks: 640 3105 e-post: turvaja@turvaja.ee http://www.turvaja.ee võõrkeeled: inglise, vene
<b>Reet MAASIKAMÄE</b>	<b>Patendibüroo Kaitsepurus OÜ</b> Mulla 4-3 10611 Tallinn telefon: 673 9097, 566 75197 telefaks: 677 4844 e-post: purus@kaitsepurus.ee http://www.kaitsepurus.ee võõrkeeled: inglise, vene	<b>Mari MUST</b>	<b>Raidla Lejins &amp; Norcoux Advokaadibüroo OÜ</b> Roosikrantsi 2, 10119 Tallinn telefon: 640 7170 telefaks: 640 7171 e-post: mari.must@rln.ee http://www.rln.ee võõrkeeled: inglise, soome
<b>Ingrid MATSINA</b>	<b>AAA Patendibüroo OÜ</b> Tartu mnt 16, 10117 Tallinn pk 3926, 10509 Tallinn telefon: 660 5910, 660 5911 telefaks: 660 5912 e-post: aaa@aaa.ee http://www.aaa.ee võõrkeeled: inglise, vene, saksa, prantsuse	<b>Tõnu NELNAS</b>	<b>AAA Patendibüroo OÜ</b> Tartu mnt 16, 10117 Tallinn pk 3926, 10509 Tallinn telefon: 660 5910, 660 5911 telefaks: 660 5912 e-post: aaa@aaa.ee http://www.aaa.ee võõrkeeled: inglise, vene, soome
<b>Raivo MATSOO</b>	<b>RM Hirvela Patendibüroo OÜ</b> Endla 3, 10122 Tallinn telefon: 614 0816 telefaks: 614 0818 e-post: hirvela@hirvela.ee võõrkeeled: inglise, vene	<b>Jüri OLT</b>	<b>Danteks OÜ</b> Tiigi 6, 51003 Tartu telefon: 508 1671 telefaks: 730 2844 e-post: jyri@danteks.net http://www.danteks.net võõrkeeled: inglise, saksa, soome, vene
<b>Elle MELLIK</b>	<b>AAA Patendibüroo OÜ</b> Tartu mnt 16, 10117 Tallinn pk 3926, 10509 Tallinn telefon: 660 5910, 660 5911 telefaks: 660 5912 e-post: aaa@aaa.ee http://www.aaa.ee võõrkeeled: inglise, vene	<b>Jaak OSTRAT</b>	<b>LASVET Patendibüroo OÜ</b> Suurtüki 4a, 10133 Tallinn pk 3136, 10505 Tallinn telefon: 640 6600 telefaks: 640 6604 e-post: lasvet@lasvet.ee http://www.lasvet.ee võõrkeeled: inglise, saksa, soome, vene
<b>Mikas MINIOTAS</b>	<b>AAA Patendibüroo OÜ</b> Tartu mnt 16, 10117 Tallinn pk 3926, 10509 Tallinn telefon: 660 5910 telefaks: 660 5912 e-post: aaa@aaa.ee http://www.aaa.ee võõrkeeled: leedu, inglise, vene		

<b>Villu PAVELTS</b>	<b>LASVET Patendibüroo OÜ</b> Suurtüki 4a, 10133 Tallinn pk 3136, 10505 Tallinn telefon: 640 6600 telefaks: 640 6604 e-post: lasvet@lasvet.ee http://www.lasvet.ee võõrkeeled: inglise, soome, vene	<b>Margus SARAP</b>	<b>Sarap ja Partnerid Patendibüroo</b> Riia 185A, 51014 Tartu telefon: 747 7058 telefaks: 747 7059 e-post: patent@patent.ee http://www.patent.ee võõrkeeled: inglise, vene
<b>Kaie PUUR</b>	<b>Patendibüroo RestMark OÜ</b> WTC Tallinn Ahtri 8, 10151 Tallinn <b>Patendibüroo RestMark OÜ</b> Kompanii 1c, 51004 Tartu telefon: 655 9803 telefaks: 747 7059 e-post: kaie.puur@restmark.ee http://www.restmark.ee võõrkeeled: inglise, vene, saksa	<b>Almar SEHVER</b>	<b>AAA Patendibüroo OÜ</b> Tartu mnt 16, 10117 Tallinn pk 3926, 10509 Tallinn telefon: 660 5910, 660 5911 telefaks: 660 5912 e-post: aaa@aaa.ee http://www.aaa.ee võõrkeeled: inglise, vene
<b>Linnar PUUSEPP</b>	<b>LASVET Patendibüroo OÜ</b> Suurtüki 4a, 10133 Tallinn pk 3136, 10505 Tallinn telefon: 640 6600 telefaks: 640 6604 e-post: lasvet@lasvet.ee http://www.lasvet.ee võõrkeeled: inglise, vene	<b>Harald TEHVER</b>	<b>Patendibüroo TURVAJA OÜ</b> Liivalaia 22, 10118 Tallinn telefon: 640 3109 telefaks: 640 3105 e-post: turvaja@turvaja.ee http://www.turvaja.ee võõrkeeled: inglise, saksa, vene
<b>Riina PÄRN</b>	<b>INTELS Patendibüroo OÜ</b> Magasini 12, 51005 Tartu telefon: 742 0401 telefaks: 742 0326 e-post: intels@intels.ee http://www.intels.ee võõrkeeled: inglise, vene	<b>Kadri TOOMSALU</b>	kutsetegevus on peatatud
<b>Tarmo ROSMAN</b>	<b>Rosman ja Partnerid OÜ</b> pk 652, 12602 Tallinn telefon: 656 1450 telefaks: 656 1450 e-post: tarman@cc.ttu.ee võõrkeeled: saksa, inglise, ungari, vene	<b>Olga TREUFELDT</b>	<b>Patendibüroo TURVAJA OÜ</b> Liivalaia 22 10118 Tallinn telefon: 640 3109 telefaks: 640 3105 e-post: turvaja@turvaja.ee http://www.turvaja.ee võõrkeeled: inglise, vene
<b>Arvo SALUMÄE</b>	<b>OÜ Amende Patendibüroo</b> J. Köleri 8, 10150 Tallinn telefon: 648 6125 telefaks: 641 0174 e-post: amende@hot.ee võõrkeeled: inglise, saksa, soome, vene	<b>Enn URGAS</b>	<b>Patendibüroo TURVAJA OÜ</b> Liivalaia 22, 10118 Tallinn telefon: 640 3109 telefaks: 640 3105 e-post: turvaja@turvaja.ee http://www.turvaja.ee võõrkeeled: inglise, vene
		<b>Juta-Maris UUSTALU</b>	<b>OÜ Amende Patendibüroo</b> J. Köleri 8, 10150 Tallinn telefon: 648 6125 telefaks: 641 0174 e-post: amende@hot.ee võõrkeeled: inglise, vene

**LIST OF PATENT ATTORNEYS, REGISTERED IN  
THE ESTONIAN STATE REGISTER OF PATENT ATTORNEYS**  
(by 4 January 2013)

Register is established on September 1<sup>st</sup> 2001

**FIELD OF ACTIVITY: TRADEMARKS, INDUSTRIAL DESIGNS AND GEOGRAPHICAL INDICATIONS**

<b>Arno ANIJALG</b>	<b>Patendibüroo Ustervall OÜ</b> Kivi 21-6 51009 Tartu, Estonia Phone: +372 744 1980 Fax: +372 744 1785 E-mail: anijalg@ustervall.ee Http://www.ustervall.ee German, Russian, Estonian	<b>Juhan HÄMMALOV</b>	<b>INTELS Patent and Trademark Agency</b> Magasini 12 51005 Tartu, Estonia Phone: +372 742 0401 Fax: +372 742 0326 E-mail: intels@intels.ee Http://www.intels.ee English, German, Russian, Estonian
<b>Aivo ARULA</b>	<b>Patent Agency Käosaar &amp; Co</b> Tähe Str. 94 50107 Tartu, Estonia Phone: +372 738 3051 Fax: +372 738 3055 E-mail: info@kaosaar.ee Http://www.kaosaar.ee English, Russian, Estonian	<b>Martin JÕGI</b>	<b>Lasvet Ltd.</b> P.O. Box 3136 10505 Tallinn, Estonia Phone: +372 640 6600 Fax: +372 640 6604 E-mail: lasvet@lasvet.ee Http://www.lasvet.ee Finnish, Russian, English, Estonian
<b>Martina BÖCKLER-LORVI</b>	<b>Lasvet Ltd.</b> P.O. Box 3136 10505 Tallinn, Estonia Phone: +372 640 6600 Fax: +372 640 6604 E-mail: lasvet@lasvet.ee Http://www.lasvet.ee English, Finnish, Estonian	<b>Uno JÄÄGER</b>	<b>Inseneribüroo Uneko Ltd.</b> Rüütli 51a 80010 Pärnu, Estonia Phone: +372 447 1021 Fax: +372 447 1001 GSM: +372 515 1844 E-mail: info@uneko.ee Http://www.uneko.ee English, Finnish, Russian, Estonian
<b>Indrek EELMETS</b>	law firm SORAINEN Pärnu Road 15 10141 Tallinn, Estonia Phone: +372 640 0900 Fax: +372 640 0901 E-mail: estonia@sorainen.com Http://www.sorainen.com English, Russian, Finnish, Estonian	<b>Sirje KAHU</b>	<b>Patendibüroo Ustervall OÜ</b> Kivi 21-6 51009 Tartu, Estonia Phone: +372 744 1980 Fax: +372 744 1785 E-mail: skahu@ustervall.ee Http://www.ustervall.ee English, Russian, Estonian
<b>Alla HÄMMALOV</b>	<b>INTELS Patent and Trademark Agency</b> Magasini 12 51005 Tartu, Estonia Phone: +372 742 0401 Fax: +372 742 0326 E-mail: intels@intels.ee Http://www.intels.ee English, Polish, Russian, Estonian	<b>Lembit KALEV</b>	<b>Patent Bureau ROOSILLA Ltd.</b> Järveotsa Road 39-61 13520 Tallinn, Estonia Phone: +372 657 1722 +372 657 5381 Fax: +372 657 5381 GSM: +372 511 9951 E-mail: roosilla@roosilla.ee Http://www.roosilla.ee English, Russian, Estonian

- Anneli KANG** **Synest Ltd.**  
P.O. Box 977  
13402 Tallinn, Estonia  
Phone: +372 660 9786  
Fax: +372 660 9787  
E-mail: anneli@synest.ee  
English, German, Russian,  
French, Finnish, Swedish,  
Estonian
- Anneli KAPP** **Patent Agency Käosaar & Co**  
Tähe Str. 94  
50107 Tartu, Estonia  
Phone: +372 738 3051  
Fax: +372 738 3055  
E-mail: info@kaosaar.ee  
Http://www.kaosaar.ee  
English, Russian, Estonian
- Urmas KAULER** **Patendibüroo TURVAJA OÜ**  
Liivalaia 22  
10118 Tallinn, Estonia  
Phone: +372 640 3109  
Fax: +372 640 3105  
E-mail: turvaja@turvaja.ee  
Http://www.turvaja.ee  
English, Russian, Finnish,  
Estonian
- Urmas KERNU** **AAA Legal Services**  
Tartu Road 16  
10117 Tallinn, Estonia  
P.O. Box 3926  
10509 Tallinn, Estonia  
Phone: +372 660 5910  
+372 660 5911  
Fax: +372 660 5912  
E-mail: aaa@aaa.ee  
Http://www.aaa.ee  
English, German, Finnish,  
Russian, Estonian
- Ljubov KESSELMAN** **Kesna Ltd.**  
Tedre Str. 77-52  
10616 Tallinn, Estonia  
Phone: +372 660 8068  
Fax: +372 660 8069  
E-mail: kesna@kesna.ee  
Http://www.kesna.ee  
English, Russian, Estonian
- Marina KESSELMAN** **Kesna Ltd.**  
Tedre Str. 77-52  
10616 Tallinn, Estonia  
Phone: +372 660 8068  
Fax: +372 660 8069  
E-mail: kesna@kesna.ee  
Http://www.kesna.ee  
English, German, Russian,  
Estonian
- Raivo KOITEL** **Patent & Trademark Agency Koitel**  
Tartu Road 65  
10115 Tallinn, Estonia  
P.O. Box 1759  
10902 Tallinn, Estonia  
Phone: +372 603 3260  
Fax: +372 603 3261  
E-mail: koitel@koitel.ee  
Http://www.koitel.ee  
English, Finnish, Russian,  
Estonian
- Katrin KOITEL-VEIDIK** **Patent & Trademark Agency Koitel**  
Tartu Road 65  
10115 Tallinn, Estonia  
P.O. Box 1759  
10902 Tallinn, Estonia  
Phone: +372 603 3260  
Fax: +372 603 3261  
E-mail: koitel@koitel.ee  
Http://www.koitel.ee  
English, Finnish, Estonian
- Mart Enn KOPPEL** **KOPPEL patendibüroo OÜ**  
Roseni 10-151  
10111 Tallinn, Estonia  
Phone: +372 677 4136  
Fax: +372 677 4138  
E-mail: info@koppelpb.com  
Http://www.koppelpb.com  
English, Russian, Finnish,  
Estonian
- Anna KOSAR** **Patent & Trademark Agency Koitel**  
Tartu Road 65  
10115 Tallinn, Estonia  
P.O. Box 1759  
10902 Tallinn, Estonia  
Phone: +372 603 3260  
Fax: +372 603 3261  
E-mail: koitel@koitel.ee  
Http://www.koitel.ee  
English, Russian, Estonian
- Heinrich KRUPP** **Patendibüroo TURVAJA OÜ**  
Liivalaia 22  
10118 Tallinn, Estonia  
Phone: +372 640 3109  
Fax: +372 640 3105  
E-mail: turvaja@turvaja.ee  
Http://www.turvaja.ee  
German, Russian, Estonian

<b>Jüri KÄOSAAR</b>	<b>Patent Agency Käosaar &amp; Co</b> Tähe Str. 94 50107 Tartu, Estonia Phone: +372 738 3051 Fax: +372 738 3055 E-mail: info@kaosaar.ee Http://www.kaosaar.ee English, Russian, Estonian	<b>Elle MELLIK</b>	<b>AAA Legal Services</b> Tartu Road 16 10117 Tallinn, Estonia P.O. Box 3926 10509 Tallinn, Estonia Phone: +372 660 5910 +372 660 5911 Fax: +372 660 5912 E-mail: aaa@aaa.ee Http://www.aaa.ee English, Russian, Estonian
<b>Kalev KÄOSAAR</b>	<b>Patent Agency Käosaar &amp; Co</b> Suur-Patarei 2 10415 Tallinn, Estonia Phone: +372 637 9484 Fax: +372 637 9485 E-mail: kalev.kaosaar@kaosaar.ee Http://www.kaosaar.ee English, Russian, Estonian	<b>Mikas MINIOTAS</b>	<b>AAA Legal Services</b> Tartu Road 16 10117 Tallinn, Estonia P.O. Box 3926 10509 Tallinn, Estonia Phone: +372 660 5910 Fax: +372 660 5912 E-mail: aaa@aaa.ee Http://www.aaa.ee Lithuanian, English, Russian, Estonian
<b>Kärt LAIGU</b>	professional activities have been suspended		
<b>Kristjan LEPPIK</b>	<b>Patendibüroo TURVAJA OÜ</b> Liivalaia 22 10118 Tallinn, Estonia Phone: +372 640 3109 Fax: +372 640 3105 E-mail: turvaja@turvaja.ee Http://www.turvaja.ee English, Russian, Estonian	<b>Lembit MITT</b>	<b>AAA Legal Services</b> Tartu Road 16 10117 Tallinn, Estonia P.O. Box 3926 10509 Tallinn, Estonia Phone: +372 660 5910 +372 660 5911 Fax: +372 660 5912 E-mail: aaa@aaa.ee Http://www.aaa.ee English, Russian, Estonian
<b>Reet MAASIKAMÄE</b>	<b>Patent Bureau Kaitsepurus</b> Mulla Str. 4-3 10611 Tallinn, Estonia Phone: +372 673 9097 +372 566 75197 Fax: +372 677 4844 E-mail: purus@kaitsepurus.ee Http://www.kaitsepurus.ee English, Russian, Estonian	<b>Ott MOORLAT</b>	<b>Moorlat &amp; Co Ltd.</b> <b>Patent Bureau</b> P.O. Box 4730 13503 Tallinn, Estonia Phone: +372 648 2085 Fax: +372 654 2844 E-mail: ott.moorlat@moorlat.ee Http://www.moorlat.ee English, Russian, Estonian
<b>Ingrid MATSINA</b>	<b>AAA Legal Services</b> Tartu Road 16 10117 Tallinn, Estonia P.O. Box 3926 10509 Tallinn, Estonia Phone: +372 660 5910 +372 660 5911 Fax: +372 660 5912 E-mail: aaa@aaa.ee Http://www.aaa.ee English, Russian, German, French, Estonian	<b>Anfia MORNA</b>	<b>Patendibüroo TURVAJA OÜ</b> Liivalaia 22 10118 Tallinn, Estonia Phone: +372 640 3109 Fax: +372 640 3105 E-mail: turvaja@turvaja.ee Http://www.turvaja.ee English, Russian, Estonian
<b>Raivo MATSOO</b>	<b>RM Hirvela Patent Bureau Ltd</b> Endla 3, 10122 Tallinn, Estonia Phone: +372 614 0816 Fax: +372 614 0818 E-mail: hirvela@hirvela.ee English, Russian, Estonian	<b>Mari MUST</b>	<b>Raidla Lejins &amp; Norcous Advokaadibüroo OÜ</b> Roosikrantsi 2 10119 Tallinn, Estonia Phone: +372 640 7170 Fax: +372 640 7171 E-mail: mari.must@rln.ee Http://www.rln.ee English, Finnish, Estonian



<b>Tõnu NELAS</b>	<b>AAA Legal Services</b> Tartu Road 16 10117 Tallinn, Estonia P.O. Box 3926 10509 Tallinn, Estonia Phone: +372 660 5910 +372 660 5911 Fax: +372 660 5912 E-mail: aaa@aaa.ee Http://www.aaa.ee English, Russian, Finnish, Estonian	<b>Linnar PUUSEPP</b>	<b>Lasvet Ltd.</b> P.O. Box 3136 10505 Tallinn, Estonia Phone: +372 640 6600 Fax: +372 640 6604 E-mail: lasvet@lasvet.ee Http://www.lasvet.ee English, Russian, Estonian
<b>Jüri OLT</b>	<b>Danteks OÜ</b> Tiigi 6 51003 Tartu, Estonia Phone: +372 508 1671 Fax: +372 730 2844 E-mail: jyri@danteks.net Http://www.danteks.net English, German, Finnish, Russian, Estonian	<b>Riina PÄRN</b>	<b>INTELS Patent and Trademark Agency</b> Magasini 12 51005 Tartu, Estonia Phone: +372 742 0401 Fax: +372 742 0326 E-mail: intels@intels.ee Http://www.intels.ee English, Russian, Estonian
<b>Jaak OSTRAT</b>	<b>Lasvet Ltd.</b> P.O. Box 3136 10505 Tallinn, Estonia Phone: +372 640 6600 Fax: +372 640 6604 E-mail: lasvet@lasvet.ee Http://www.lasvet.ee English, German, Finnish, Russian, Estonian	<b>Tarmo ROSMAN</b>	<b>Rosman and Partners Ltd.</b> P.O. Box 652 12602 Tallinn, Estonia Phone: +372 656 1450 Fax: +372 656 1450 E-mail: tarman@cc.ttu.ee German, English, Hungarian, Russian, Estonian
<b>Villu PAVELTS</b>	<b>Lasvet Ltd.</b> P.O. Box 3136 10505 Tallinn, Estonia Phone: +372 640 6600 Fax: +372 640 6604 E-mail: lasvet@lasvet.ee Http://www.lasvet.ee English, Finnish, Russian, Estonian	<b>Arvo SALUMÄE</b>	<b>AMENDE Patent Agency Ltd.</b> J. Köleri 8, 10150 Tallinn, Estonia Phone: +372 648 6125 Fax: +372 641 0174 E-mail: amende@hot.ee English, German, Finnish, Russian, Estonian
<b>Kaie PUUR</b>	<b>Patendibüroo RestMark OÜ</b> WTC Tallinn Ahtri 8 10151 Tallinn, Estonia <b>Patendibüroo RestMark OÜ</b> Kompanii 1c 51004 Tartu, Estonia Phone: +372 655 9803 Fax: +372 747 7059 E-mail: kaie.puur@restmark.ee Http://www.restmark.ee English, Russian, German, Estonian	<b>Margus SARAP</b>	<b>Sarap ja Partnerid Patendibüroo</b> Riia 185A 51014 Tartu, Estonia Phone: +372 747 7058 Fax: +372 747 7059 E-mail: patent@patent.ee Http://www.patent.ee English, Russian, Estonian
		<b>Almar SEHVER</b>	<b>AAA Legal Services</b> Tartu Road 16 10117 Tallinn, Estonia P.O. Box 3926 10509 Tallinn, Estonia Phone: +372 660 5910 +372 660 5911 Fax: +372 660 5912 E-mail: aaa@aaa.ee Http://www.aaa.ee English, Russian, Estonian

<b>Harald TEHVER</b>	<b>Patendibüroo TURVAJA OÜ</b> Liivalaia 22 10118 Tallinn, Estonia Phone: +372 640 3109 Fax: +372 640 3105 E-mail: turvaja@turvaja.ee Http://www.turvaja.ee English, German, Russian, Estonian	<b>Enn URGAS</b>	<b>Patendibüroo TURVAJA OÜ</b> Liivalaia 22 10118 Tallinn, Estonia Phone: +372 640 3109 Fax: +372 640 3105 E-mail: turvaja@turvaja.ee Http://www.turvaja.ee English, Russian, Estonian
<b>Kadri TOOMSALU</b>	professional activities have been suspended	<b>Juta-Maris UUSTALU</b>	<b>AMENDE Patent Agency Ltd.</b> J. Köleri 8, 10150 Tallinn, Estonia Phone: +372 648 6125 Fax: +372 641 0174 E-mail: amende@hot.ee English, Russian, Estonian
<b>Olga TREUFELDT</b>	<b>Patendibüroo TURVAJA OÜ</b> Liivalaia 22 10118 Tallinn, Estonia Phone: +372 640 3109 Fax: +372 640 3105 E-mail: turvaja@turvaja.ee Http://www.turvaja.ee English, Russian, Estonian		