

EVE VÄRV

MATEMAATIKA TÖÖRAAMAT

1. KLASSILE

2. OSA



EVE VÄRV

MATEMAATIKA
TÖÖRAAMAT

1. KLASSILE

2. OSA

2014



Euroopa Liit
Euroopa Sotsiaalfond



Eesti tuleviku heaks



Hariduslike erivajadustega
õpilaste õppevara arendamine

Eve Värv. Matemaatika tööraamat 1. klassile. II osa

Tööraamat vastab põhikooli lihtsustatud riikliku õppekava lihtsustatud õppele

Tööraamatu koostamist konsulteeris *Meelika Maila*
Retsenseerinud *Merje Hendrikson, Tiiu Kaljas*

Toimetanud ja küljendanud *Tiina Helekivi*
Illustreerinud *Ülle Meister, Vilve Aavik-Vadi*
Kaane kujundanud *Eve Kurm*
Tehniliselt toimetanud *Andero Kurm*

Raamatu väljaandmist on toetanud Euroopa Sotsiaalfond ja Eesti riik programmi „Hariduslike erivajadustega õpilaste õppevara arendamine“ kaudu.

Programmi viib ellu SA Innove. 

Kõik õigused kaitstud. Igasugune autoriõigusega kaitstud materjali ebaseaduslik paljundamine ja levitamine toob kaasa seaduses ettenähtud vastutuse.

Autoriõigus: SA Innove, Eve Värv, 2014

ISBN 978-9949-547-55-5 (kogu teos)
ISBN 978-9949-547-56-2 (kogu teos: pdf)
ISBN 978-9949-547-57-9 (I osa)
ISBN 978-9949-547-58-6 (I osa: pdf)
ISBN 978-9949-547-59-3 (II osa)
ISBN 978-9949-547-60-9 (II osa: pdf)
ISBN 978-9949-547-61-6 (III osa)
ISBN 978-9949-547-62-3 (III osa: pdf)

Trükiettevalmistus:
Kirjastus Studium
Riia 15b
Tartu 51010

Trükitud: OÜ Greif trükikojas
Lohkva, Luunja vald
Tartumaa 62207

1 ÜKS

1

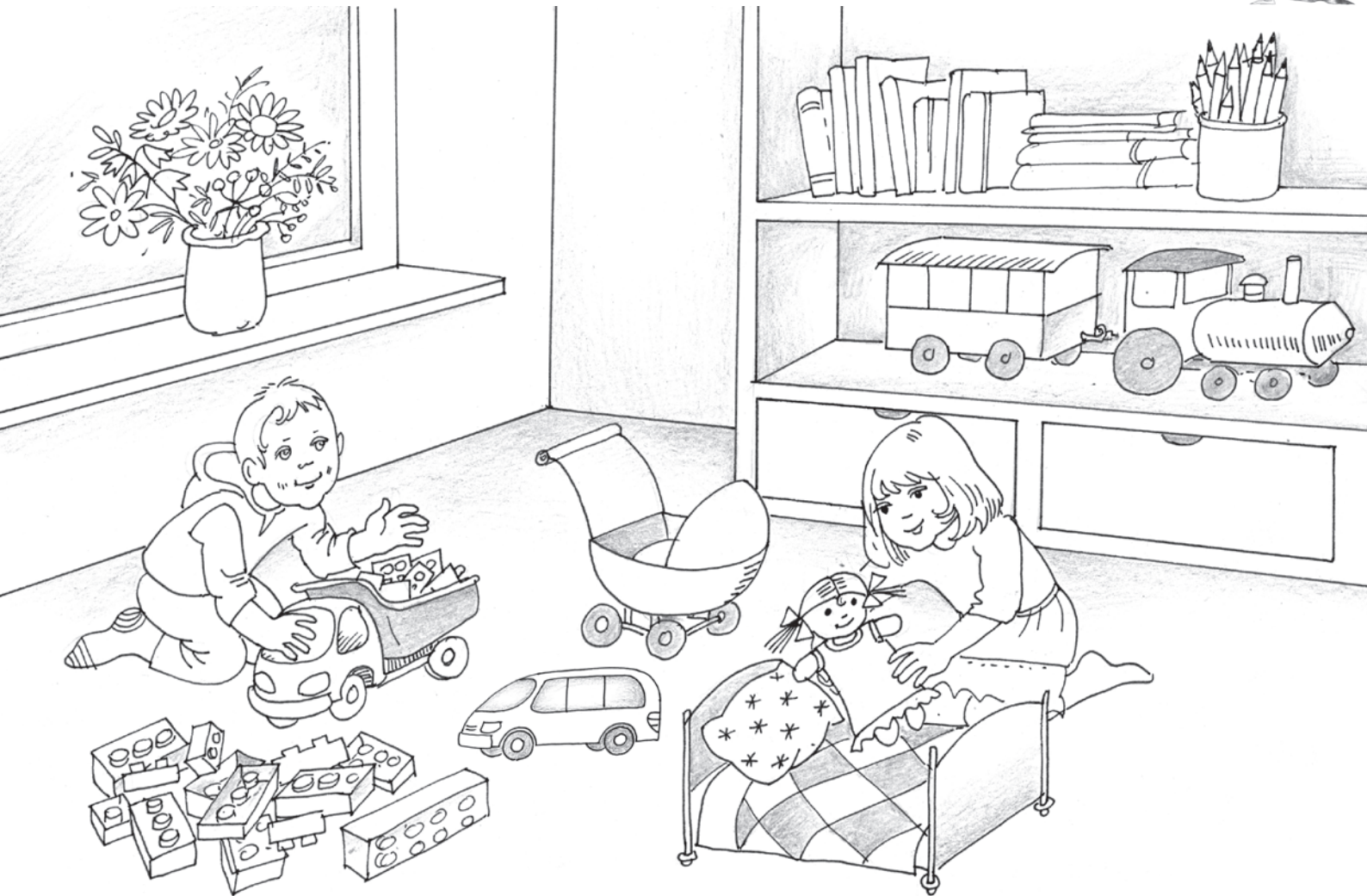

MIDA ON PILDIL ÜKS?

MIDA ON PILDIL PALJU?

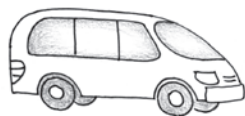

VÄRVI NII+SAMA PALJU RUUTE.

ERALDA HULGAD JOONEGA.

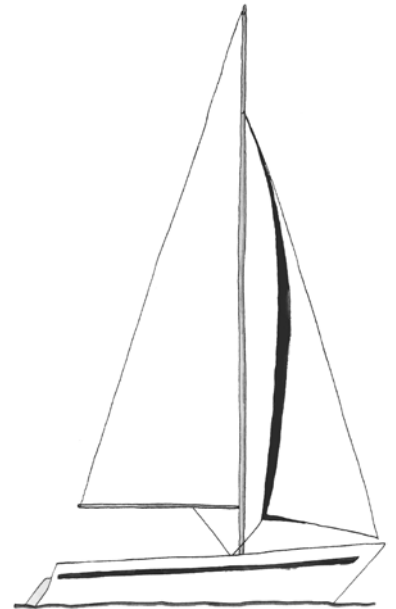
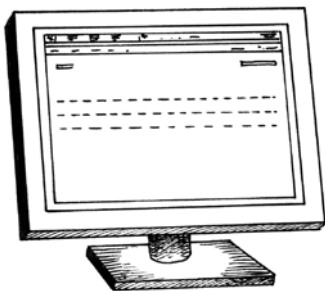
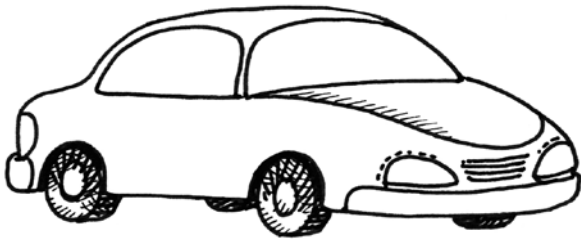
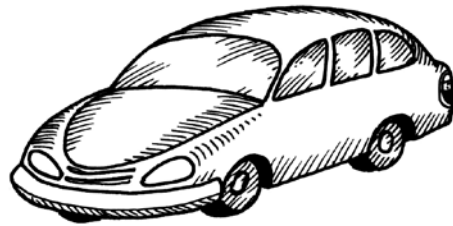

VÄRVI IGAS HULGAS ÜKS ESE.

JÄTKA RIDA.

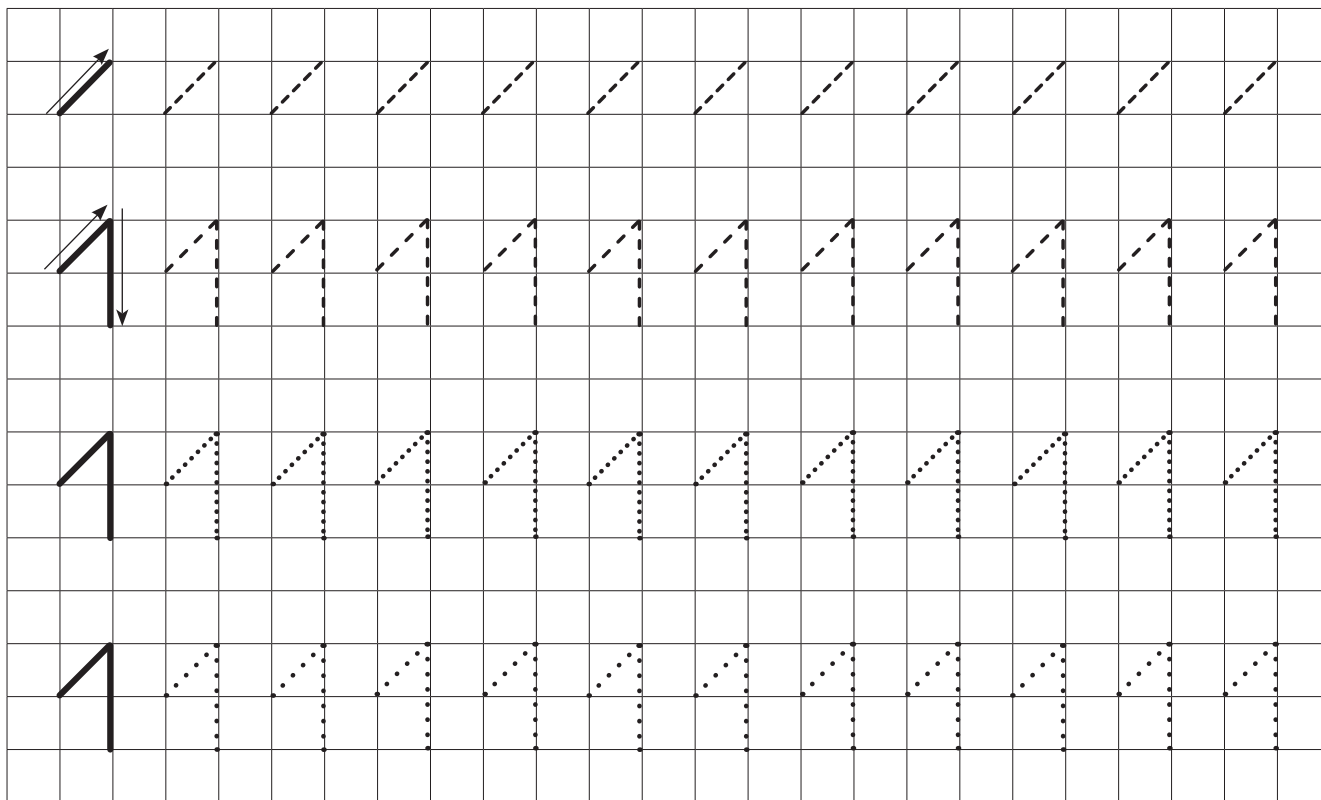

PIIRA SARNASED ESEMED JOONEGA.

ÜHENDA NUMBRIGA HULGAD, MILLES ON ÜKS ESE.

VÄRVI NEED HULGAD.

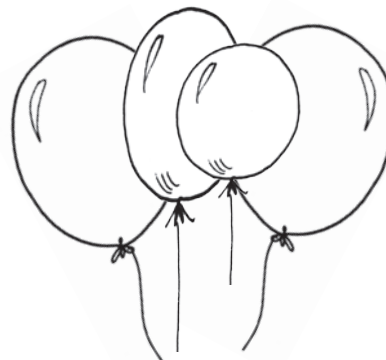
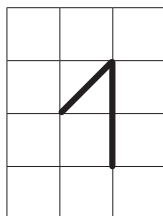
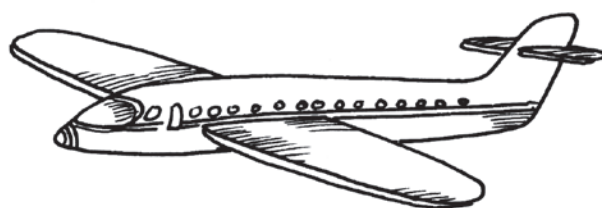
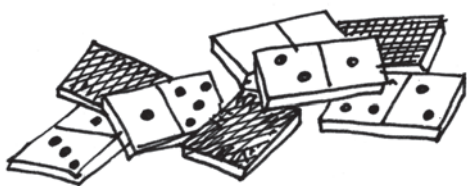

LEIA VALESTI KIRJUTATUD NUMBRID. PÕHJENDA.

ÕIGESTI KIRJUTATUD NUMBER KIRJUTA ÜLE.

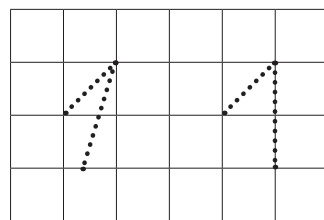
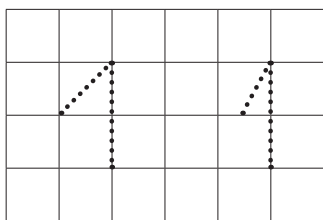
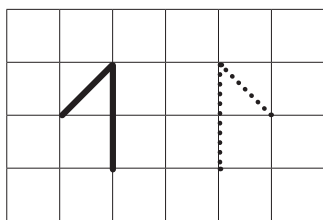

KIRJUTA ÕIGESTI.

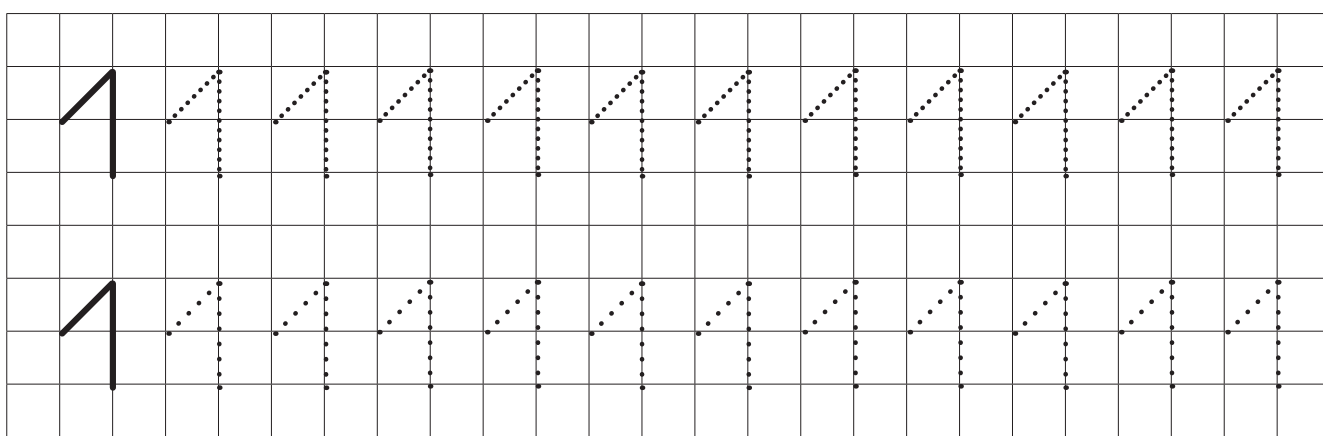

KIRJUTA NUMBER 1 PILDI JUURDE, KUS ON ÜKS ESE.

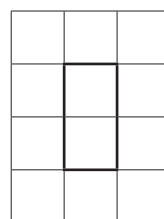
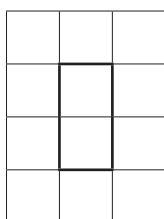
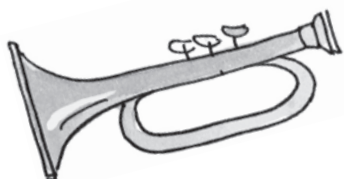
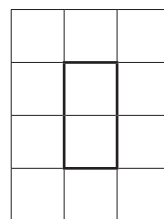
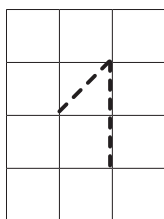
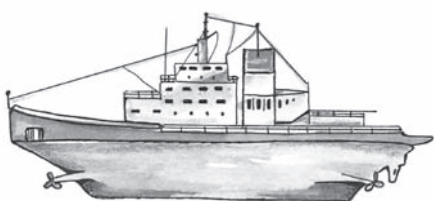

2 KAKS

1

2



MIS ON PILDIL? MITU?



VÄRVI NII+SAMA PALJU RUUTE.

ERALDA HULGAD JOONEGA.
VÄRVI IGAS HULGAS KAKS ESET.



MITU ESET ON HULGAS?

TÕMBA ÕIGELE ARVULE RING ÜMBER.

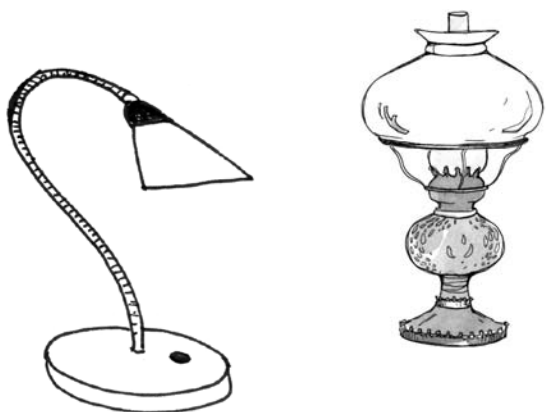

		1				2									

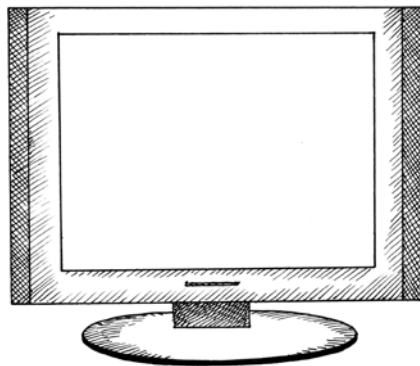

				1						2					











































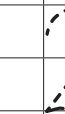

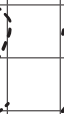















				1						2					

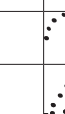

				1						2					

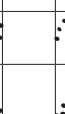
JÄTKA RIDA.

PIIRA SARNASED ESEMED JOONEGA. **ÜHENDA** ESEMETE HULK NUMBRIGA. **VÄRVI** HULGAD, MILLES ON KAKS ESET.

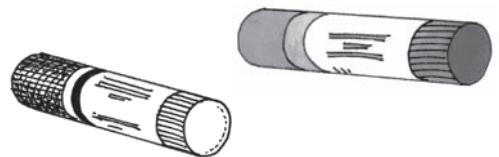
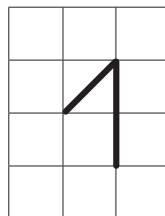
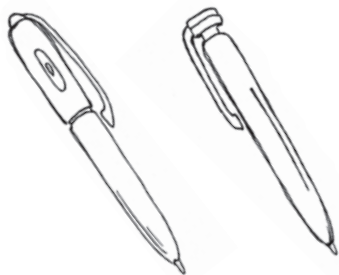

KIRJUTA ÕIGE ARV.



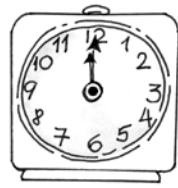
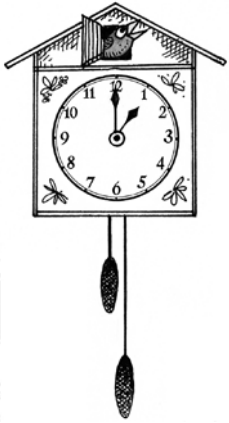









LEIA VALESTI KIRJUTATUD NUMBRID. PÕHJENDA.

ÕIGESTI KIRJUTATUD NUMBER KIRJUTA ÜLE.

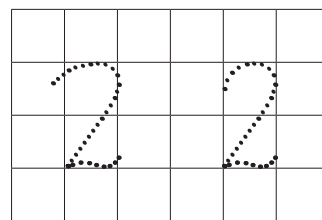
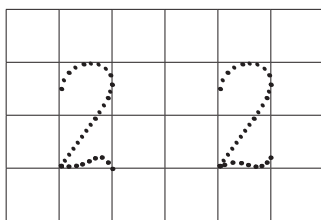
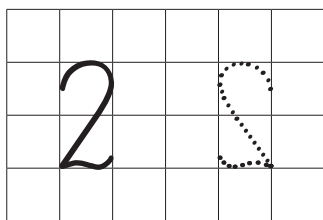

KIRJUTA ÕIGESTI.

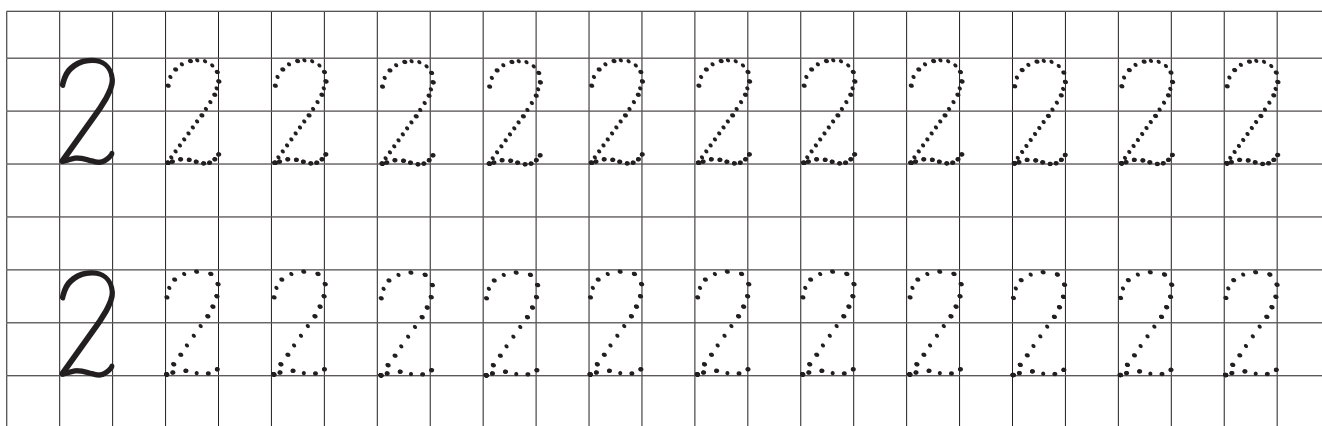

ÜHENDA JOONEGA ARV, SÕNA JA PILT.

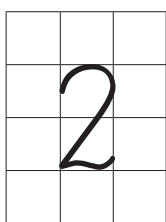

ÜKS

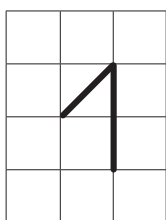
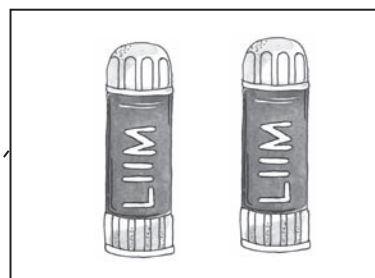

KAKS

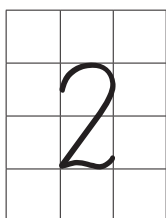
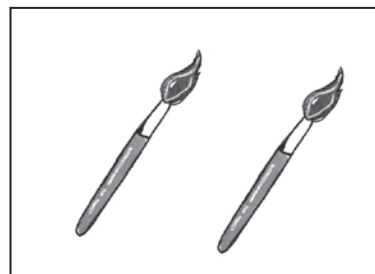

KAKS

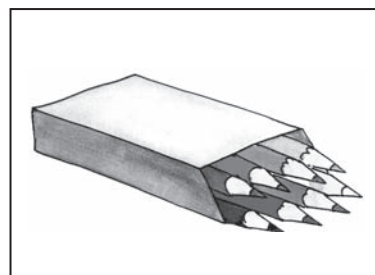

VÖRDLE HULKI.



2 RAAMATUT ON KUI 1 RAAMAT.



ROHKEM
VÄHEM
NII+SAMA PALJU

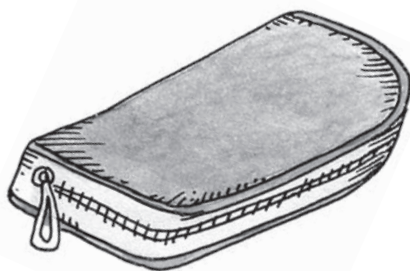

1 PINAL ON KUI 2 PLIATSIT.



ROHKEM
VÄHEM
NII+SAMA PALJU

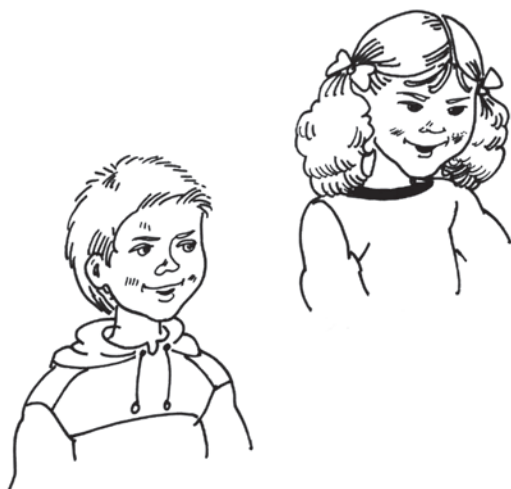

2 LAST ON KUI 2 KOOLI+KOTTI.



ROHKEM
VÄHEM
NII+SAMA PALJU

VÄRVI SÕIDUKID.

PIIRA NUKK JOONEGA.

PIIRA MÄNGU+ASJAD JOONEGA.

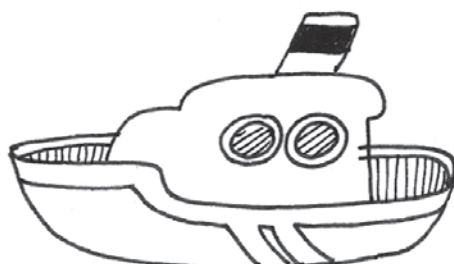
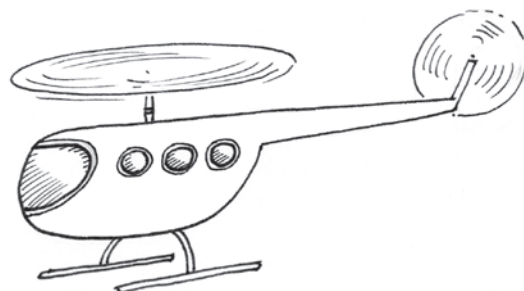
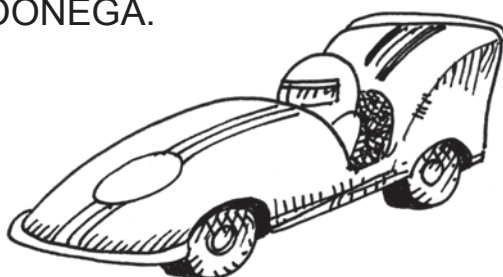

PIIRA PLIIATSID JOONEGA.

VÄRVI PINAL.

PIIRA KOOLI+TARBED JOONEGA.

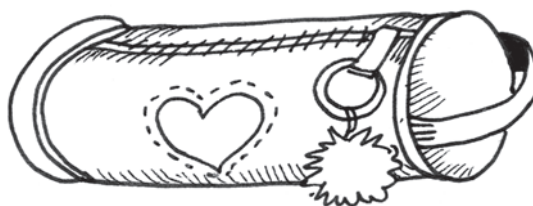
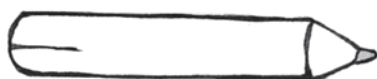
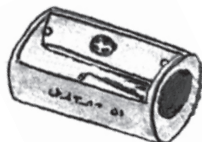
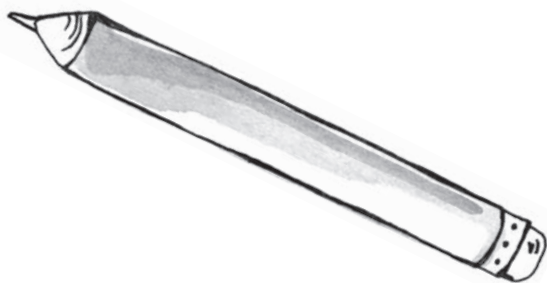

PIIRA PLIIATSITE HULK JOONEGA.

VÄRVI PEENIKESED PLIIATSID.

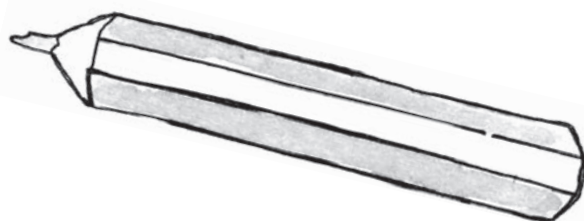
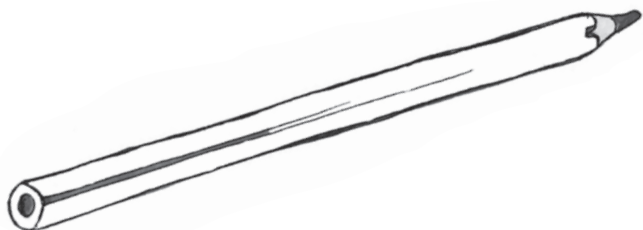

PIIRA ALBUMITE HULK JOONEGA.

VÄRVI PAKSEM ALBUM.

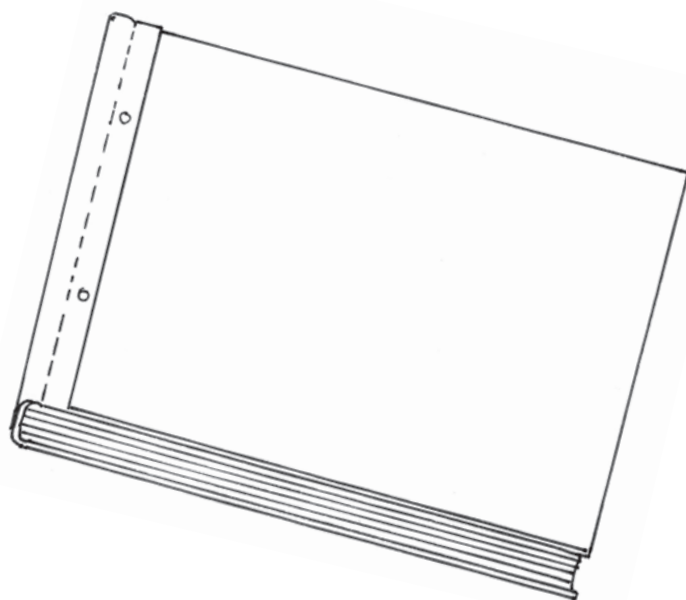
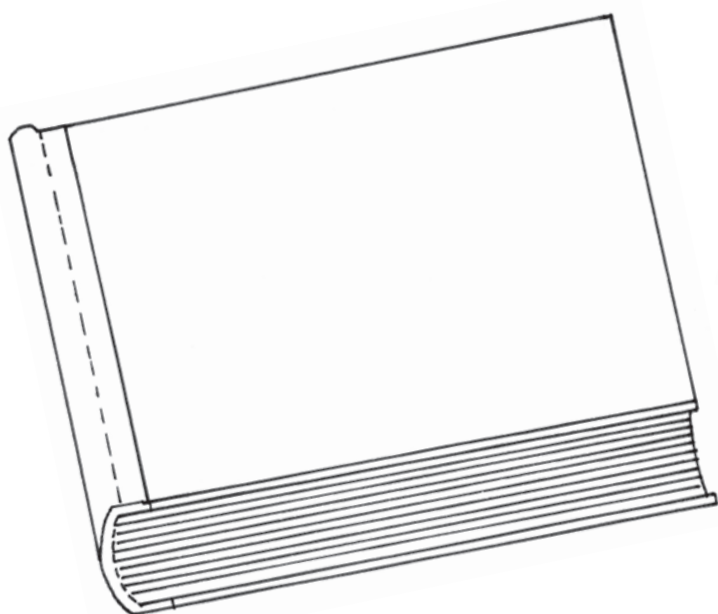

MITMES?

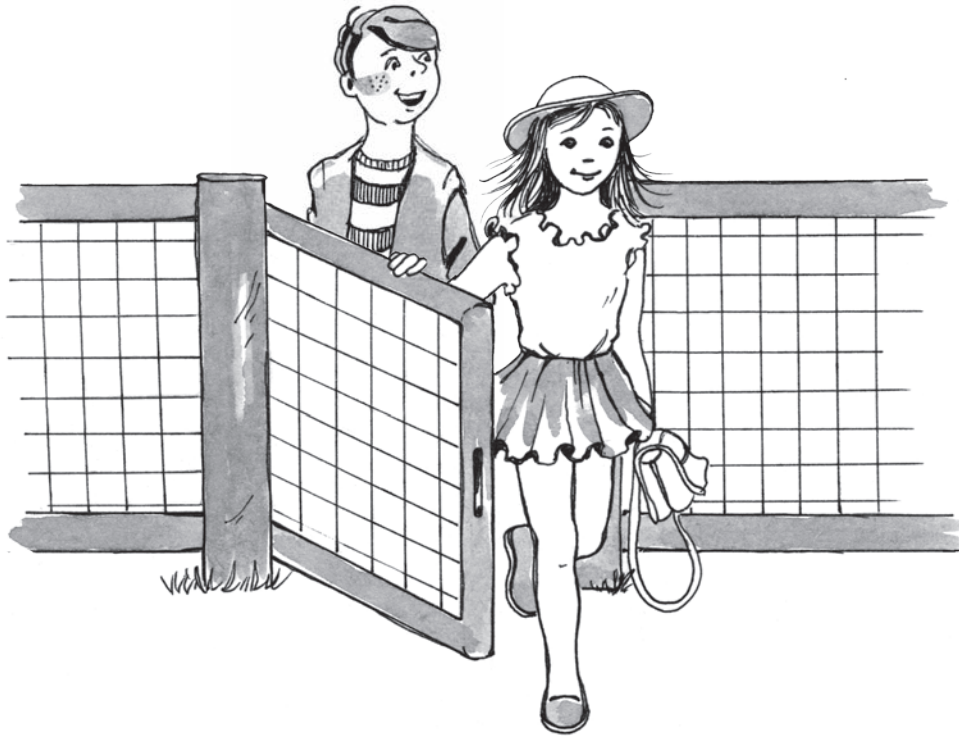

RÄÄGI. TÜDRUK ON **ESIMENE**.
POISS ON **TEINE**.



RÄÄGI. TÜDRUK ON

POISS ON

ESIMENE

TEINE

MITU? MITMES?

MITU TOOLI ON?

VÄRVI. ESIMENE TOOL ON PRUUN.
TEINE TOOL ON ROHELINE.

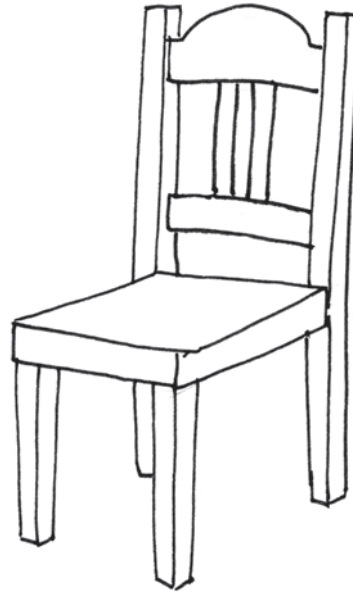
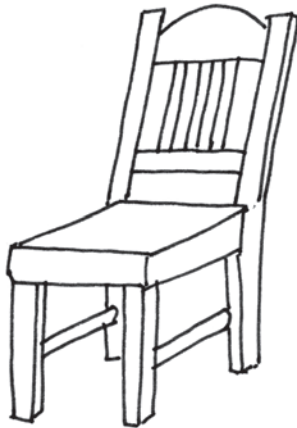

VÖRDLE. MADALAM TOOL ON
KÕRGEM TOOL ON

ESIMENE
TEINE

MITU JAKKI ON?

VÄRVI. ESIMENE JAKK ON SININE.
TEINE JAKK ON KOLLANE.



VÖRDLE. PIKEM JAKK ON
LÜHEM JAKK ON

ESIMENE
TEINE

RÄÄGI PILTIDE JÄRGI.



OLI _____. _____ TULEB JUURDE. NÜÜD ON _____.

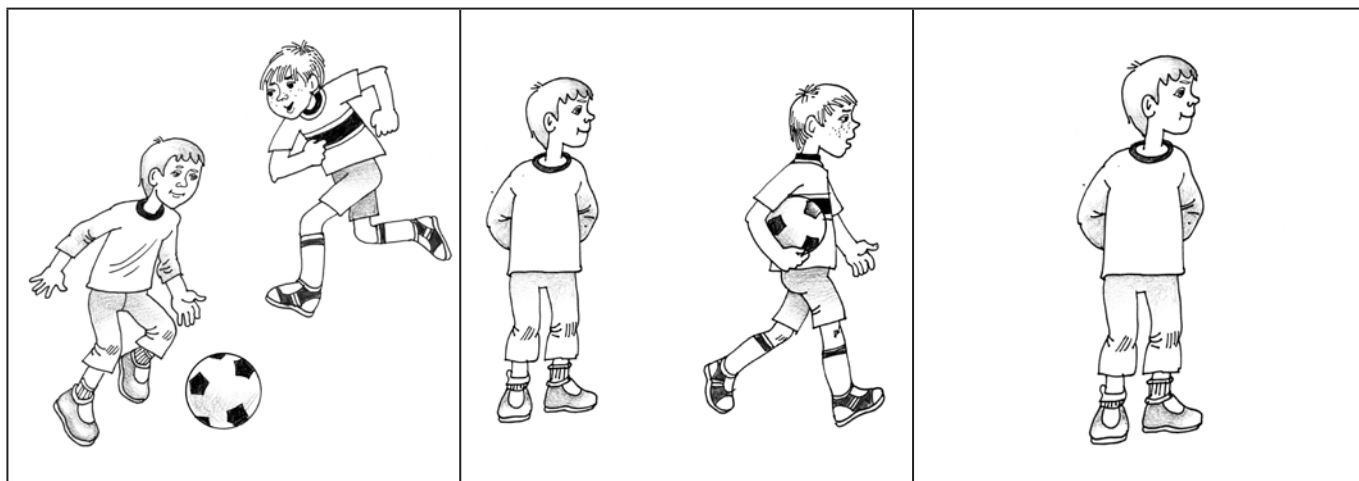

OLI _____. _____ LÄHEB ÄRA. NÜÜD ON _____.

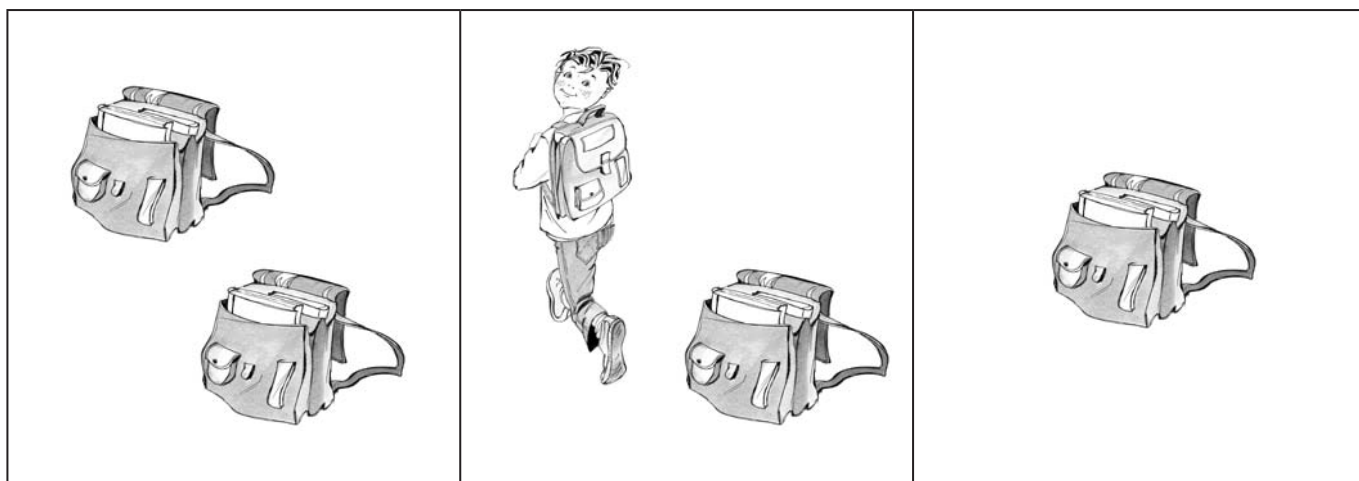

OLI _____. _____ VIIB ÄRA. NÜÜD ON _____.

3 KOLM

1 2

3

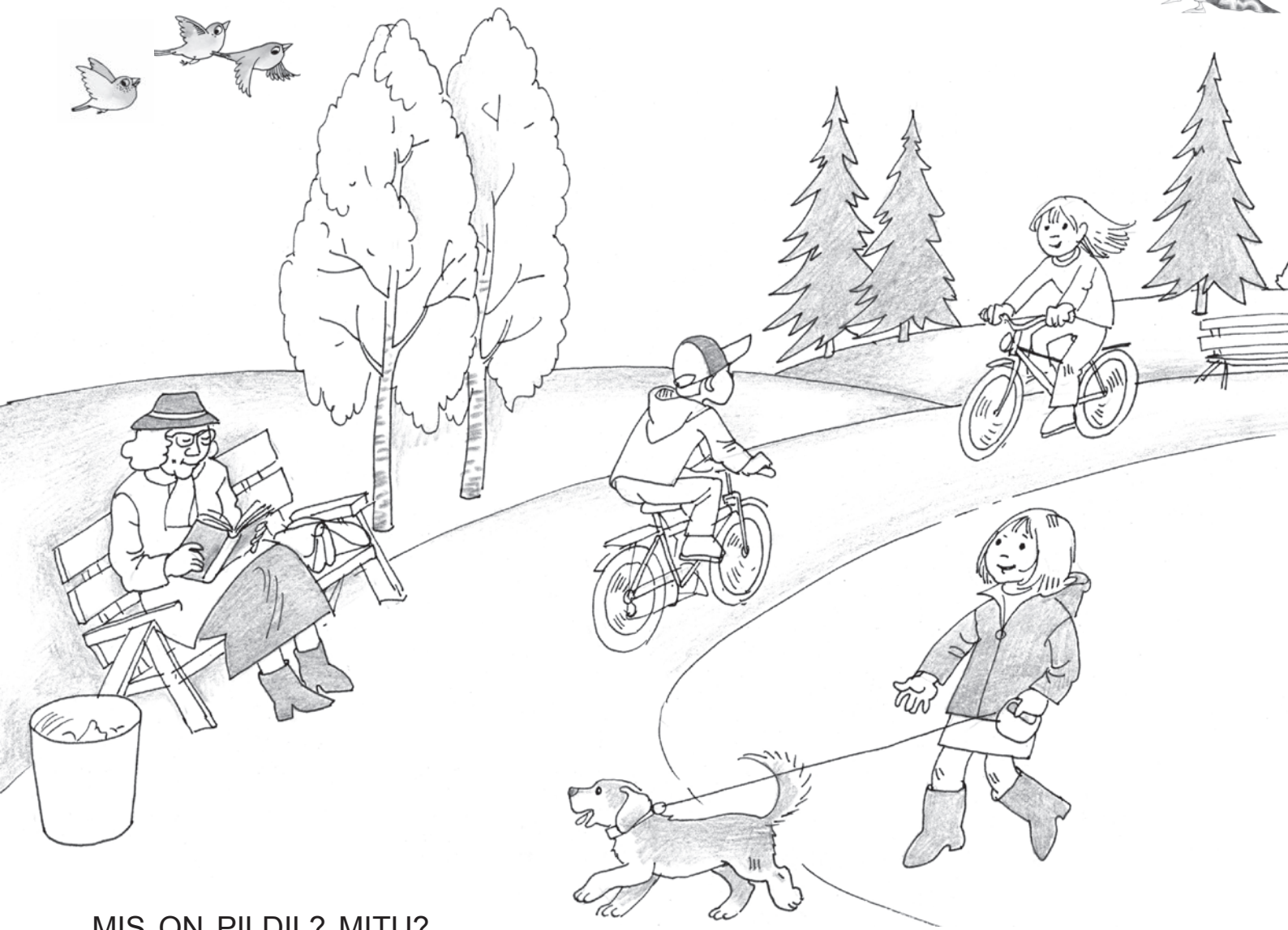

MIS ON PILDIL? MITU?



VÄRVI NII+SAMA PALJU RUUTE.

ERALDA HULGAD JOONEGA.

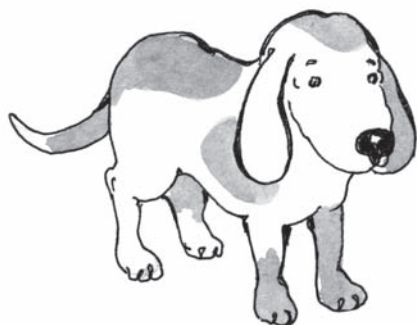
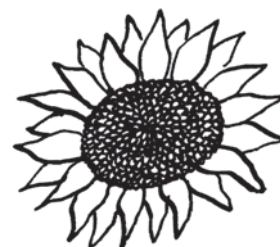
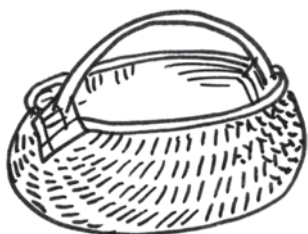
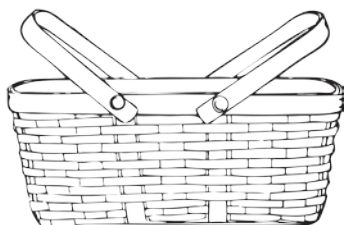

VÄRVI IGAS HULGAS KOLM ESET.

ERALDA HULK JOONEGA. MITU ESET ON HULGAS?

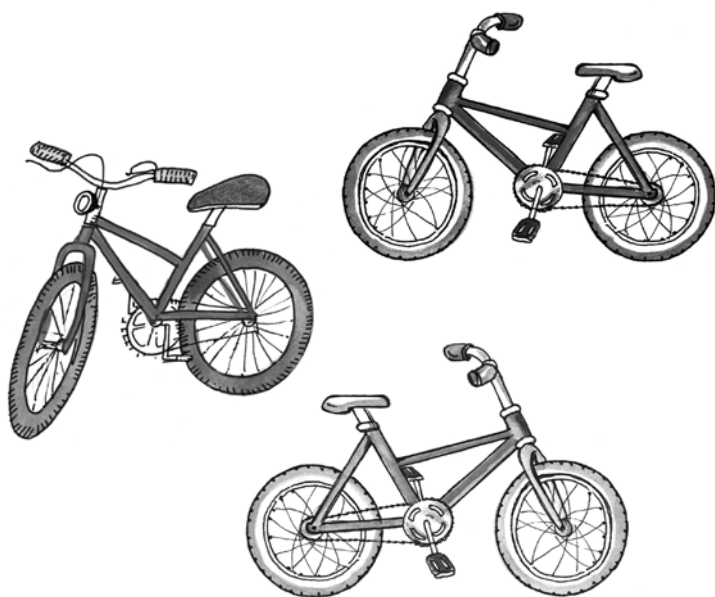

	1	2	3						



	1	2	3						

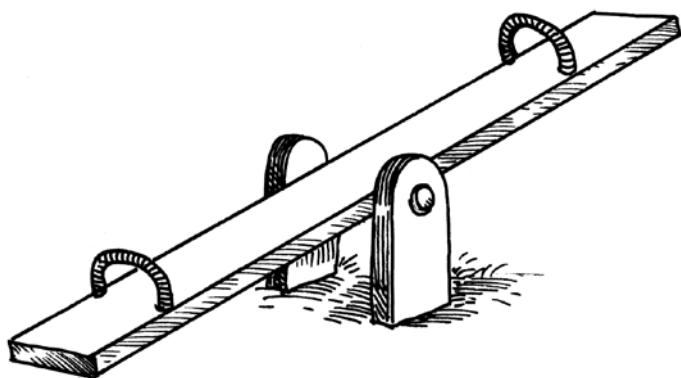

	1	2	3						

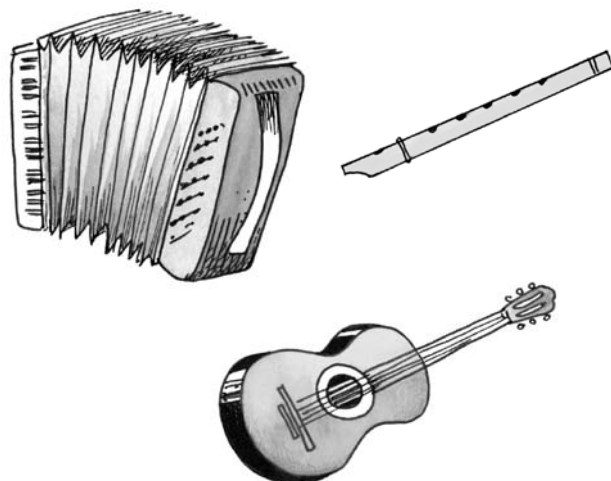

	1	2	3						

TÕMBA ÕIGELE ARVULE RING ÜMBER.

JÄTKA RIDA.

2	2	2	2	2	2	2	2	2	2	2	2	2	2	2	2	2	2	2	2	2	2	2
3	3	3	3	3	3	3	3	3	3	3	3	3	3	3	3	3	3	3	3	3	3	3
3	3	3	3	3	3	3	3	3	3	3	3	3	3	3	3	3	3	3	3	3	3	3
3	3	3	3	3	3	3	3	3	3	3	3	3	3	3	3	3	3	3	3	3	3	3
3	3	3	3	3	3	3	3	3	3	3	3	3	3	3	3	3	3	3	3	3	3	3

KIRJUTA PUUDUVAD ARVUD.

4 2

LOE ARVU+RIDA. VÄRVI RUUDUD.

KIRJUTA ÕIGE ARV.

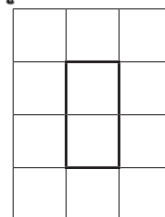
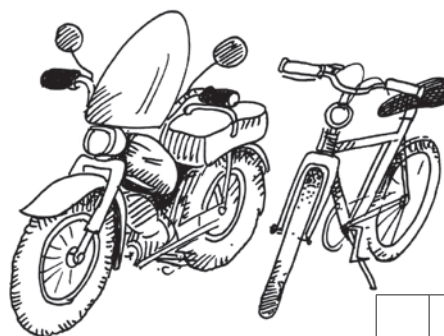
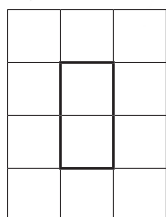
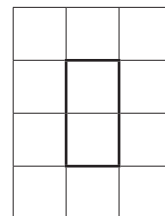
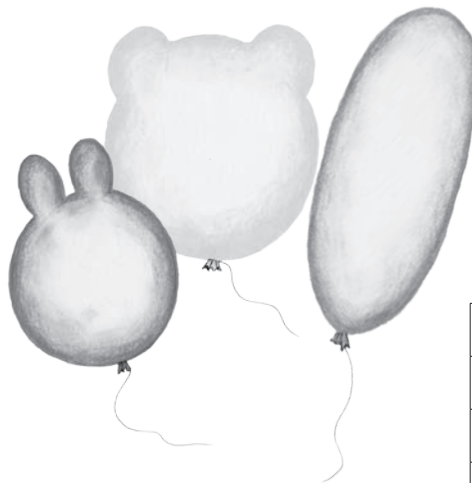
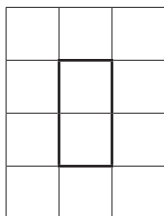

MITU RUUTU ON VÄRVITUD?

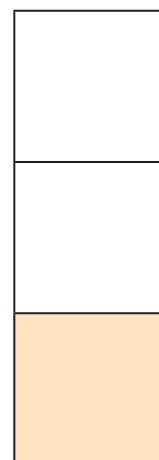
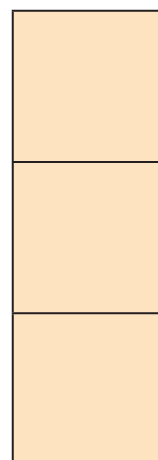
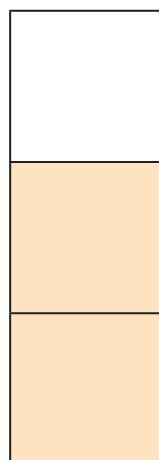
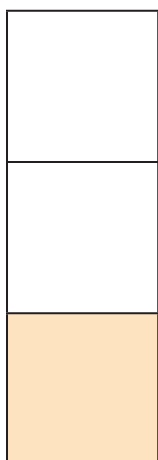
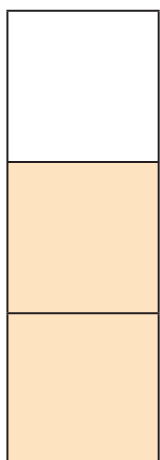

LEIA VALESTI KIRJUTATUD NUMBRID. PÕHJENDA.

ÕIGESTI KIRJUTATUD NUMBER KIRJUTA ÜLE.

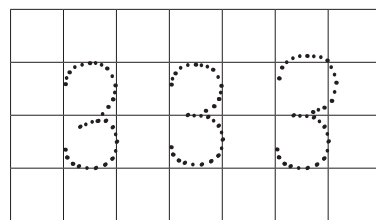
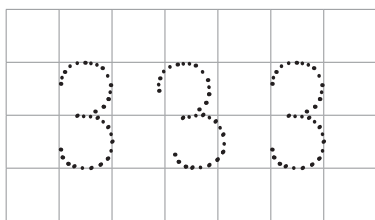
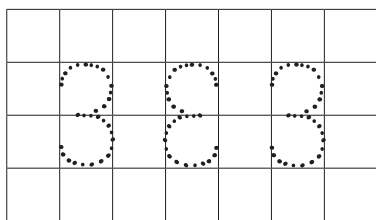

KIRJUTA ÕIGESTI.

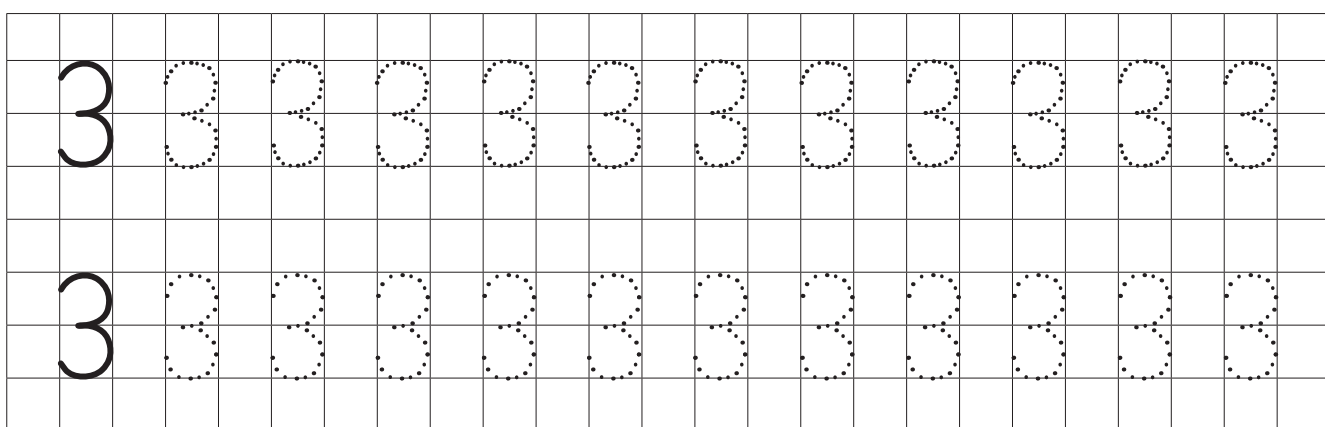

ÜHENDA JOONEGA ARV, SÕNA JA PILT.

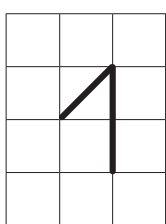

KOLM

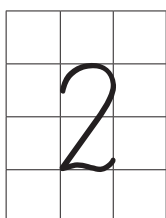

KAKS

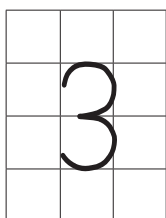

ÜKS

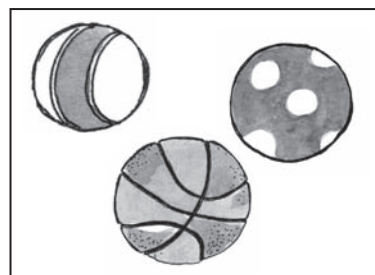

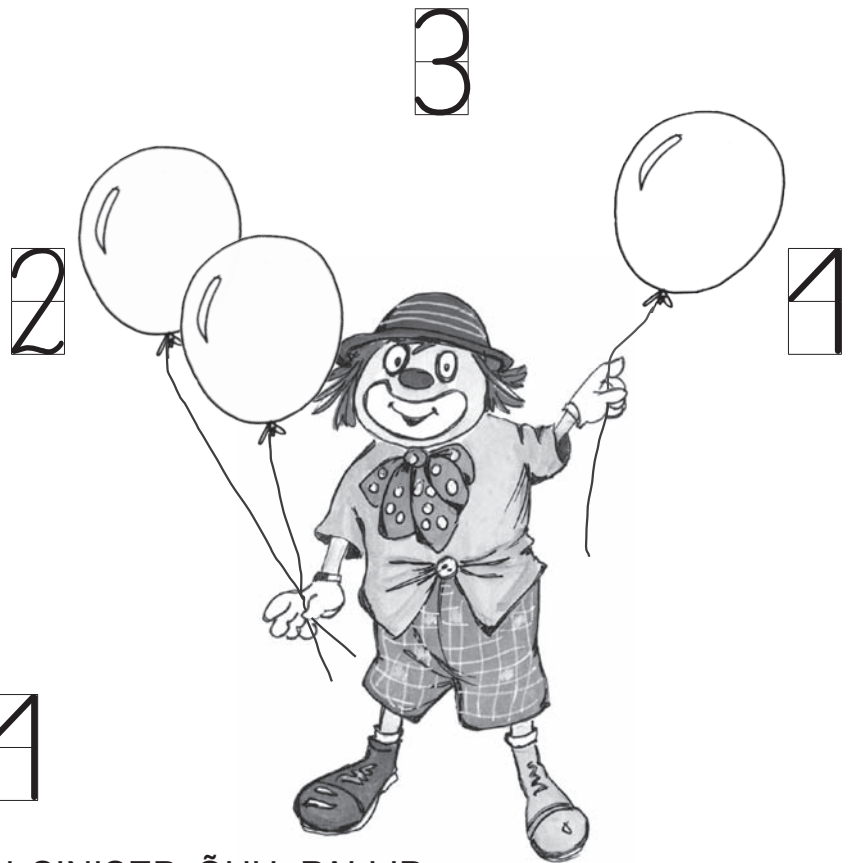

RÄÄGI. 3 ON 2 JA 4

VÄRVI. PAREMAS KÄES ON SINISED ÕHU+PALLID.
VASAKUS KÄES ON ROHELINE ÕHU+PALL.

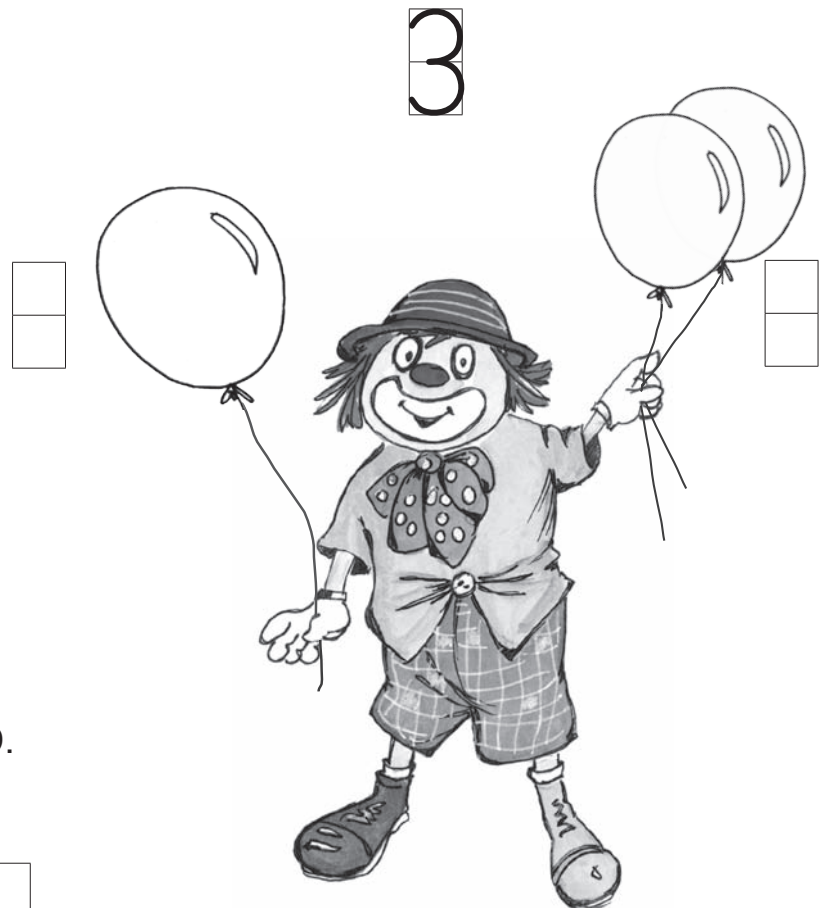

KIRJUTA PUUDUVAD ARVUD.

RÄÄGI. ON JA

KIRJUTA PUUDUVAD ARVUD.

3









RÄÄGI.

ON

JA

KIRJUTA PUUDUVAD ARVUD. RÄÄGI.

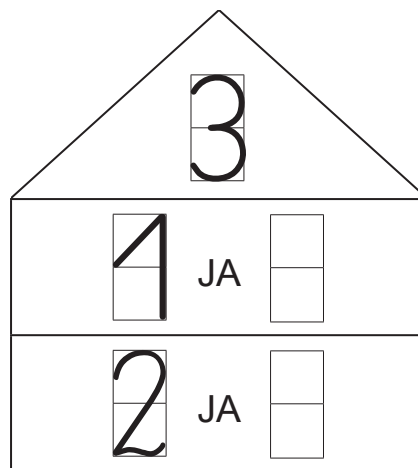
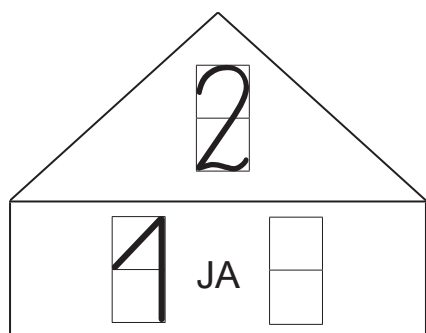

VÖRDLE HULKI.

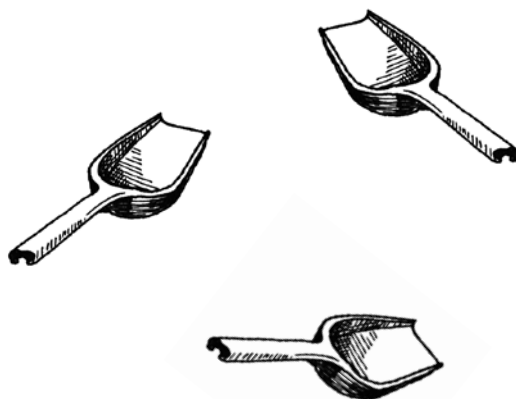

1 ÄMBER ON KUI 3 KÜHVLIIT.

ROHKEM
VÄHEM
NII+SAMA PALJU

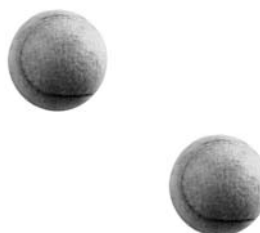

2 REKETIT ON KUI 2 PALLI.

ROHKEM
VÄHEM
NII+SAMA PALJU

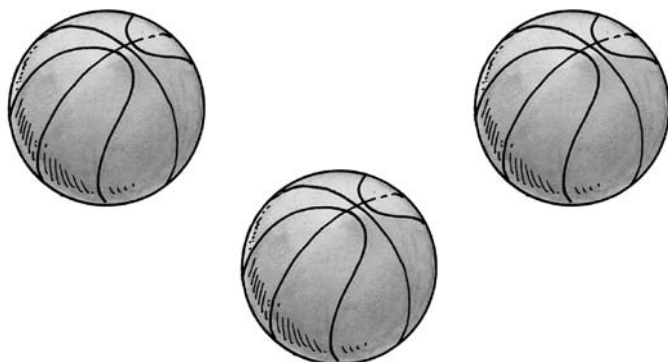

3 KORV+PALLI ON KUI 1 KORV.

ROHKEM
VÄHEM
NII+SAMA PALJU

VÖRDLE HULKI.



1 KÜÜNLA+JALG ON KUI 3 KÜÜNALT.

ROHKEM

VÄHEM

NII+SAMA PALJU



1 TASKU+LAMP ON KUI 2 PATAREID.

ROHKEM

VÄHEM

NII+SAMA PALJU

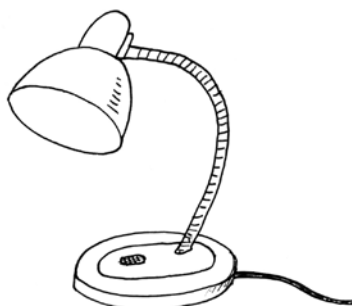
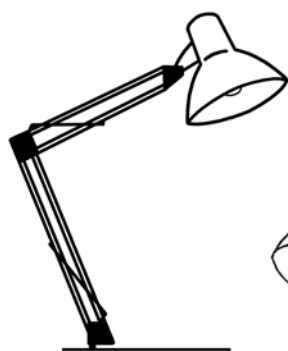
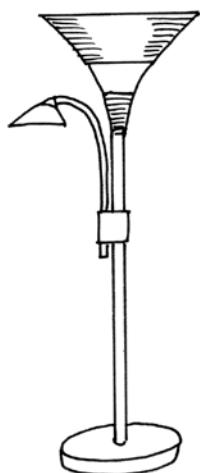

3 LAMPI ON KUI 3 ELEKTRI+PIRNI.

ROHKEM

VÄHEM

NII+SAMA PALJU

VÖRDLE HULKI JA ARVE.

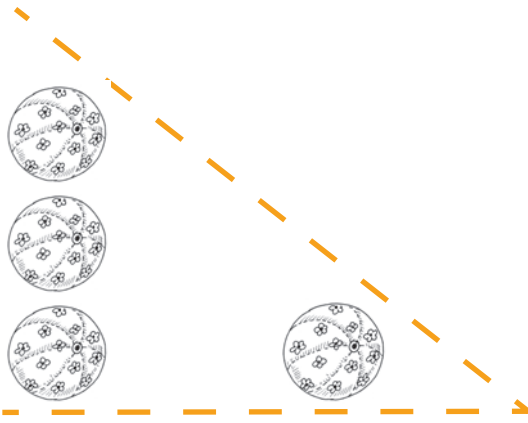

VÖRDLE HULKI.

KOLM PALLI ON **ROHKEM** KUI ÜKS PALL.

VÖRDLE ARVE.

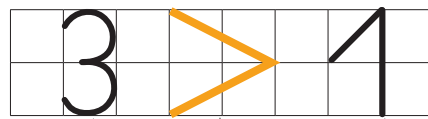

KOLM ON **SUUREM** KUI ÜKS.

VÖRDLE HULKI.

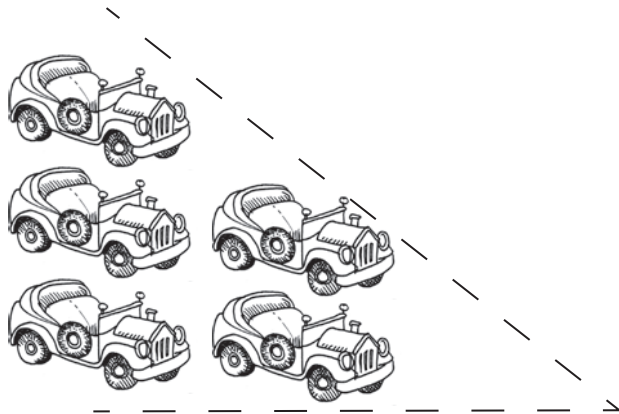

KOLM AUTOT ON KUI KAKS AUTOT.

VÖRDLE ARVE.

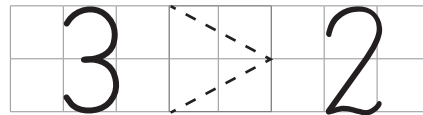

KOLM ON KUI KAKS.

JÄTKA RIDA.

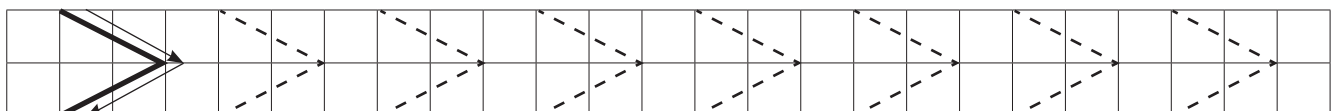

VÖRDLE HULKI JA ARVE.



KAKS LAMPI ON

KUI ÜKS LAMP.

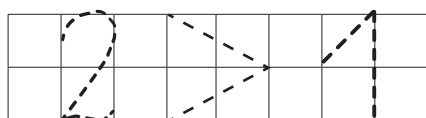

KAKS ON

KUI ÜKS.

SUUREM
ROHKEM

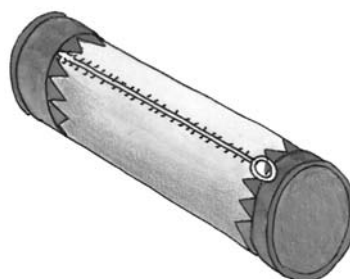
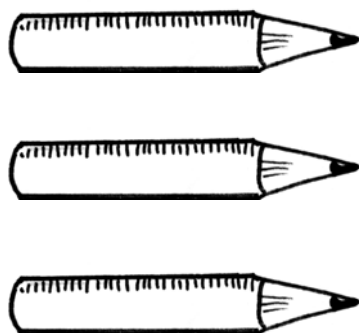

KOLM PLIIATSIT ON

KUI ÜKS PINAL.

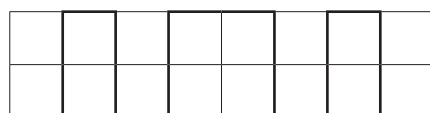

KOLM ON

KUI ÜKS.

ROHKEM
SUUREM

VÄRVI NEED, MIDA ON ROHKEM.

VÖRDLE HULKI JA ARVE.



..... ON KUI



..... ON KUI

SUUREM
ROHKEM

KIRJUTA PUUDUVAD ARVUD JA MÄRGID.

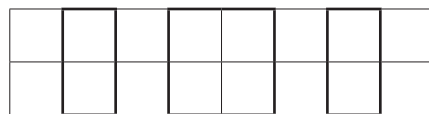
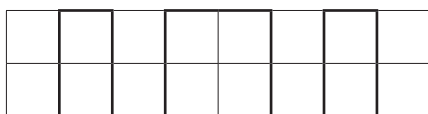
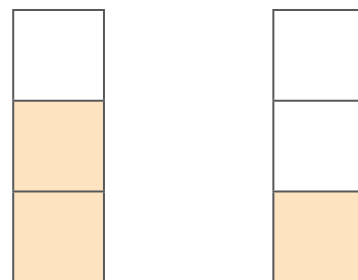
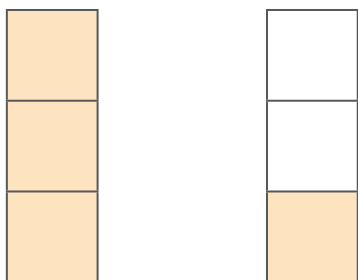

VÄRVI VAJALIK ARV RUUTE. VÖRDLE ARVE. KIRJUTA MÄRK.

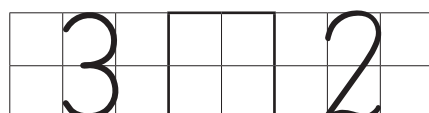
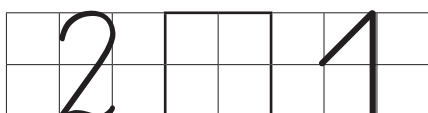
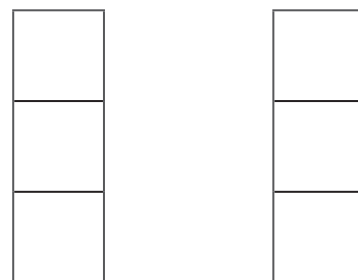
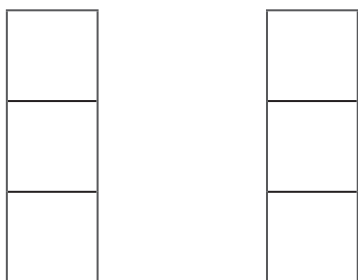

VÖRDLE HULKI JA ARVE.

VÖRDLE HULKI.

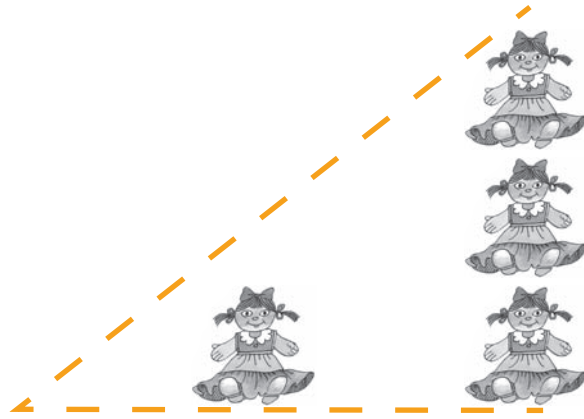

ÜKS NUKK ON **VÄHEM** KUI KOLM NUKKU.

VÖRDLE ARVE.

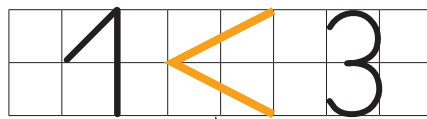

ÜKS ON **VÄIKSEM** KUI KOLM.

VÖRDLE HULKI.

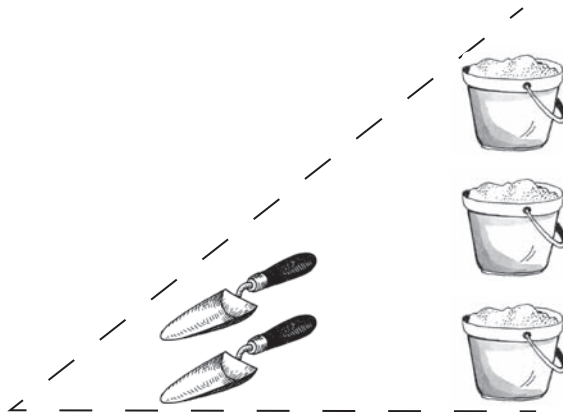

KAKS KÜHVLIIT ON KUI KOLM ÄMBRIT.

VÖRDLE ARVE.

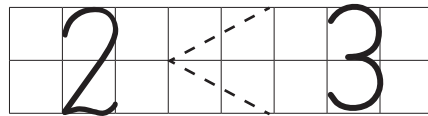

KAKS ON KUI KOLM.

VÄIKSEM
VÄHEM

JÄTKA RIDA.

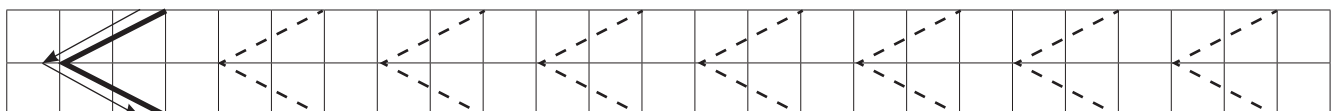

VÖRDLE HULKI JA ARVE.



ÜKS VAAS ON KUI KOLM LILLE.

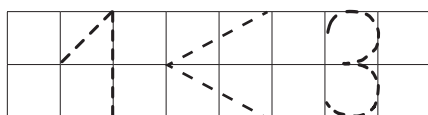

ÜKS ON KUI KOLM.

VÄIKSEM
VÄHEM

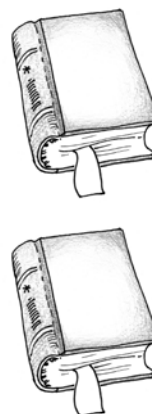

ÜKS KOTT ON KUI KAKS RAAMATUT.



ÜKS ON KUI KAKS.

VÄHEM
VÄIKSEM

VÄRVI NEED, MIDA ON VÄHEM.

VÖRDLE HULKI JA ARVE.

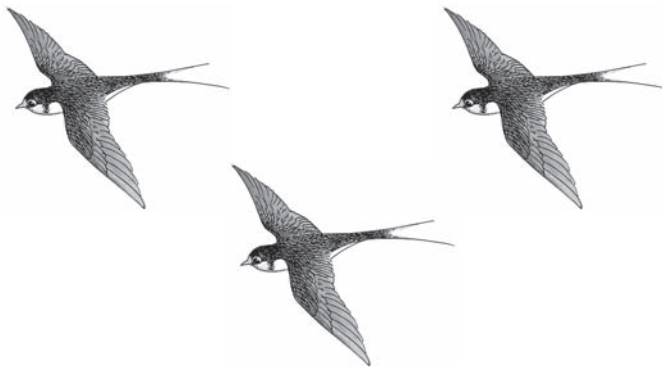

..... ON KUI

..... ON KUI

VÄIKSEM
VÄHEM

KIRJUTA PUUDUVAD ARVUD JA MÄRGID.

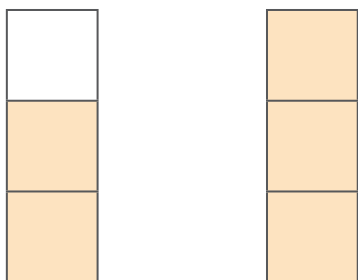

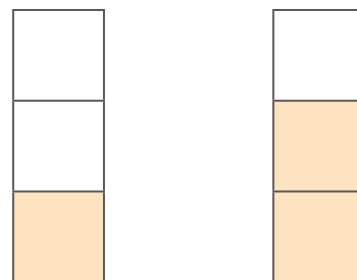

VÄRVI VAJALIK ARV RUUTE. VÖRDLE ARVE. KIRJUTA MÄRK.

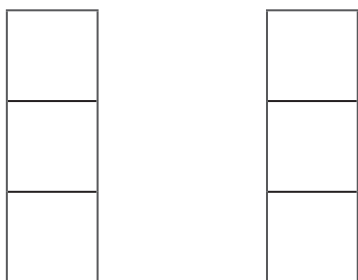

1				3

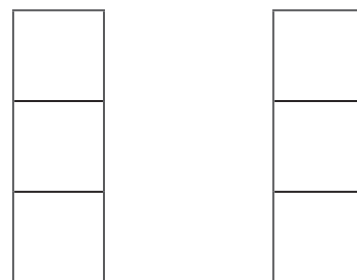

2				3

VÖRDLE HULKI JA ARVE.

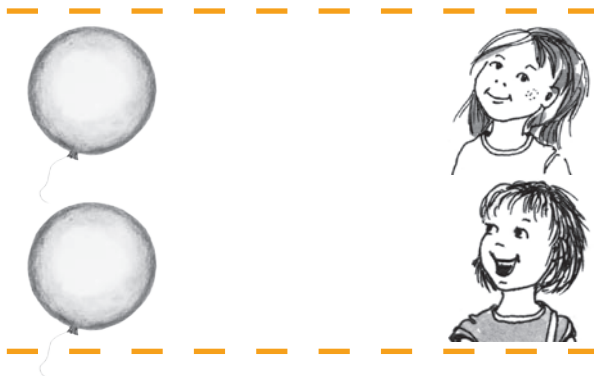

KAKS ÕHU+PALLI ON **NII+SAMA PALJU** KUI KAKS TÜDRUKUT.
ÕHU+PALLE JA TÜDRUKUID ON **VÖRDSELT**.

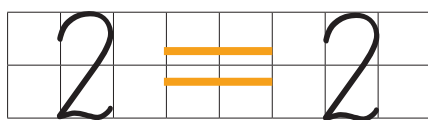

KAKS ON **VÖRDNE** KAHEGA.

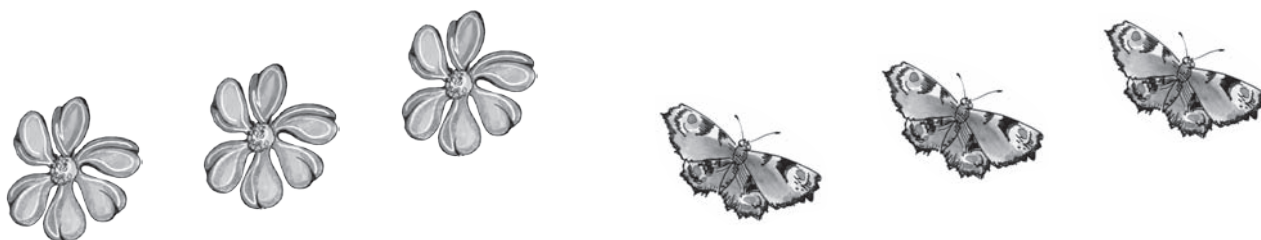

KOLM LILLE ON KUI KOLM LIBLIKAT.

LILLI JA LIBLIKAID ON .

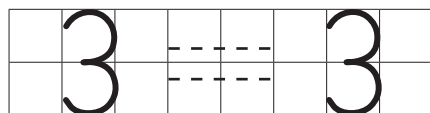

KOLM ON KOLMEGA.

NII+SAMA PALJU
VÖRDSELT
VÖRDNE

JÄTKA RIDA.

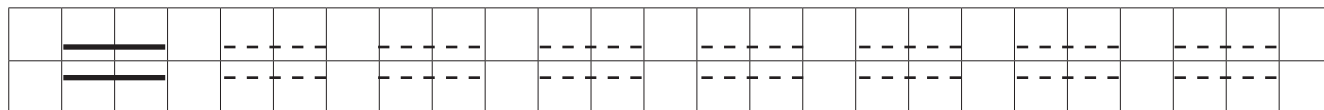

VÖRDLE HULKI JA ARVE.



KAKS NUKKU ON KUI KAKS VANKRIT.

2	=	2
---	---	---

KAKS ON KAHEGA.

NII+SAMA PALJU
VÖRDNE



..... ON KUI

..... ON GA.

NII+SAMA PALJU
VÖRDNE

VÖRDLE HULKI JA ARVE.

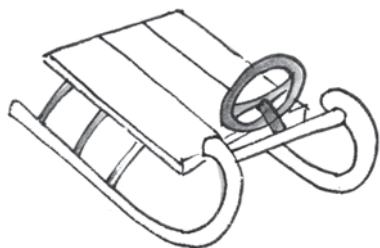

..... ON KUI



..... ON GA.

NII+SAMA PALJU
VÖRDNE

KIRJUTA PUUDUVAD ARVUD JA MÄRGID.

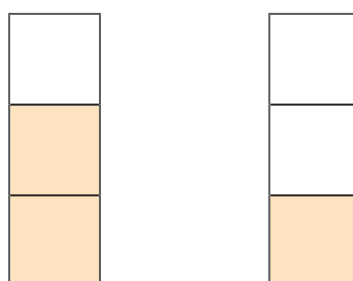
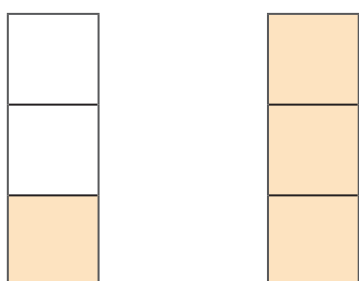
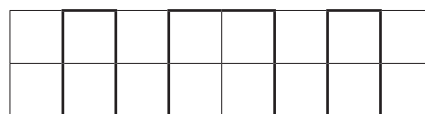
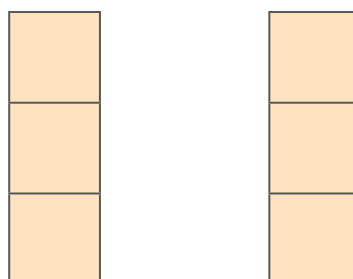
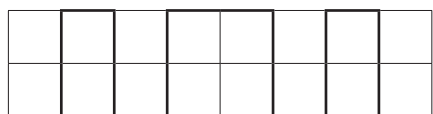
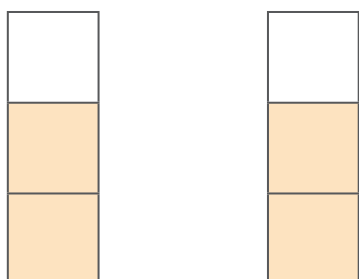

PIIRA NOOLE+MÄNG JOONEGA.

VÄRVI NOOLED.

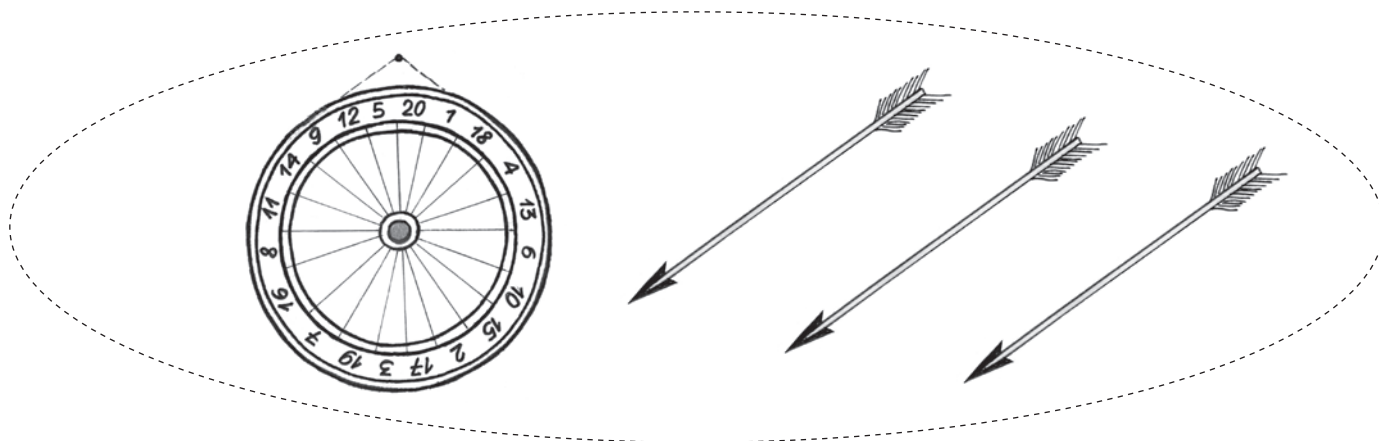

PIIRA KURIKA+MÄNG JOONEGA.

PIIRA KURIKAD JOONEGA.

VÄRVI PALL.

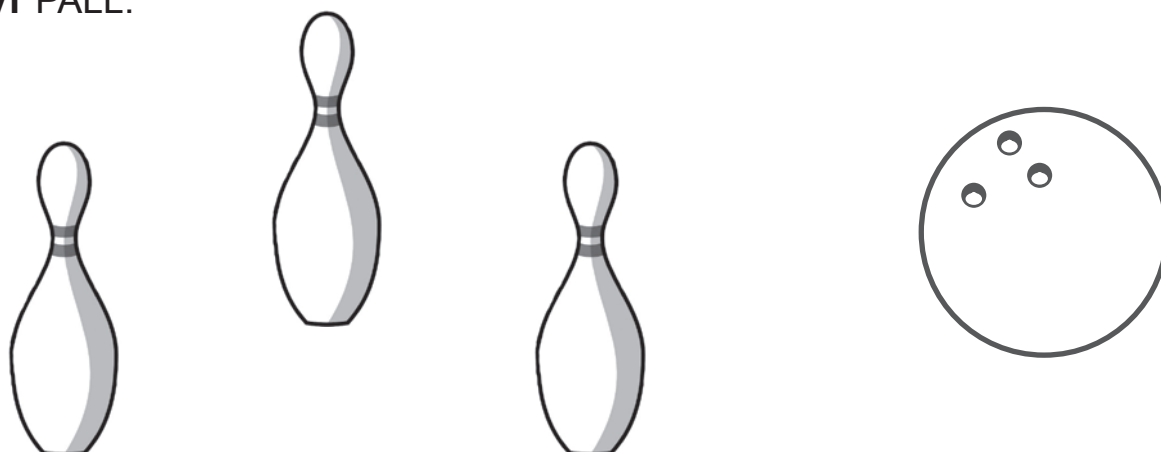

PIIRA TÄRINGUD JOONEGA.

VÄRVI NUPUD.

PIIRA MÄNG JOONEGA.

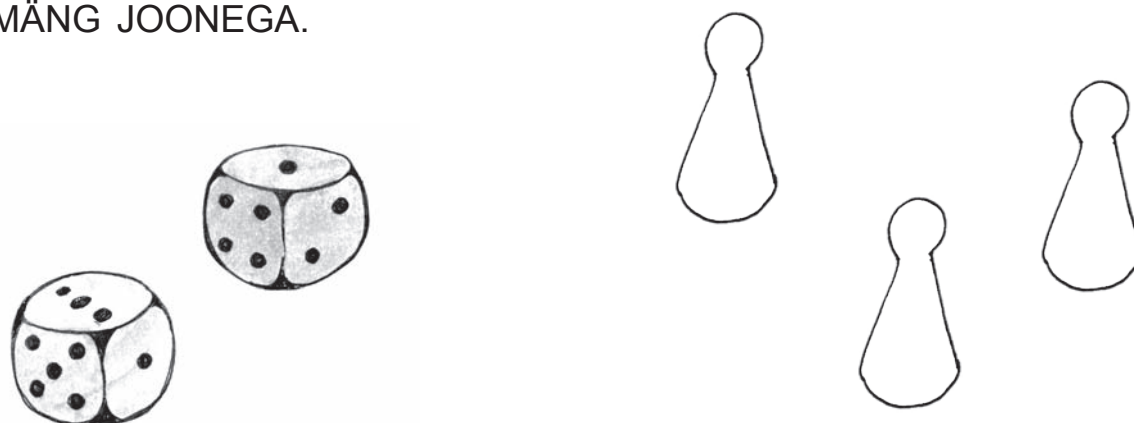

MITMES?

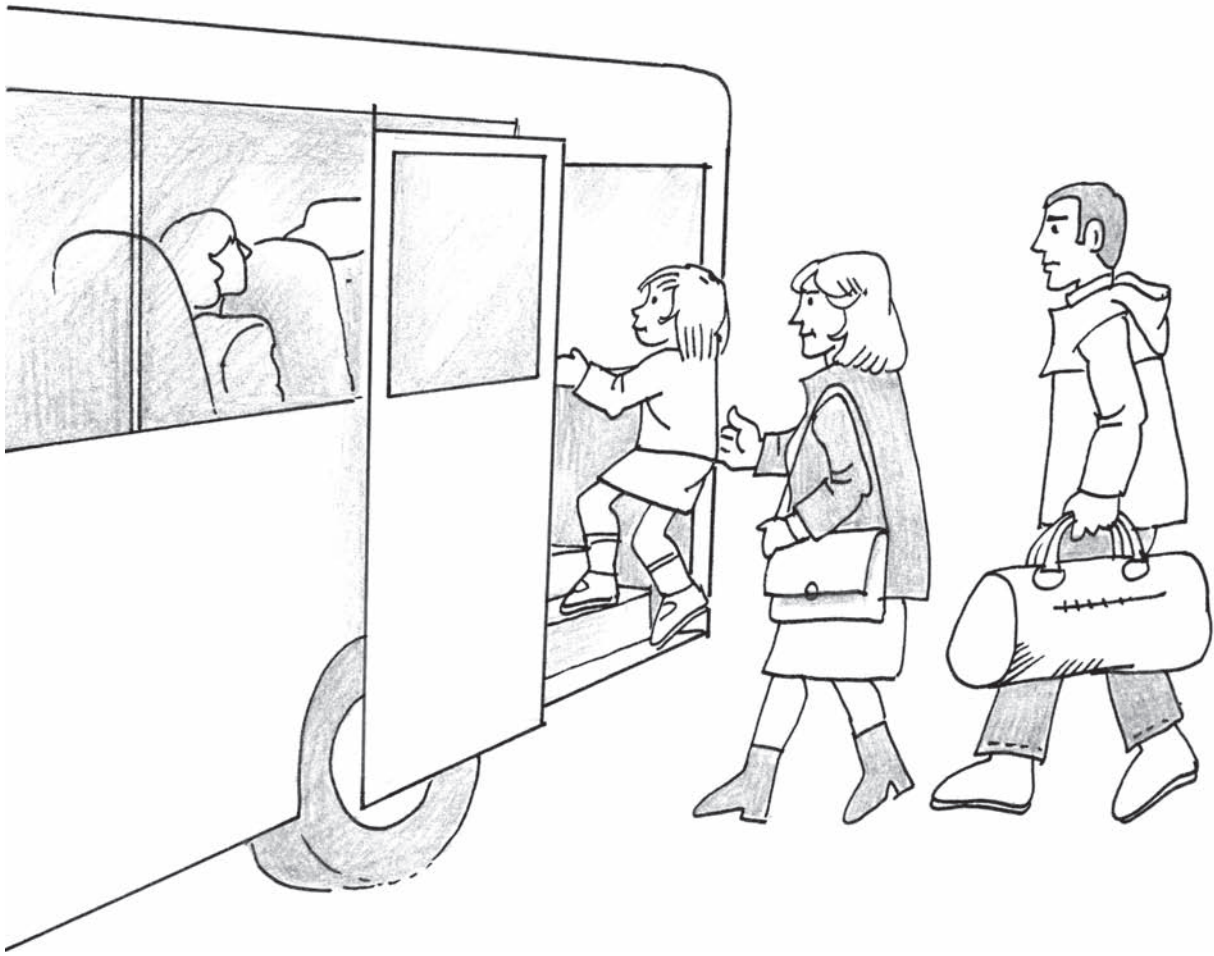

RÄÄGI. TÜDRUK ON
EMA ON
ISA ON **KOLMAS.**

TEINE
ESIMENE

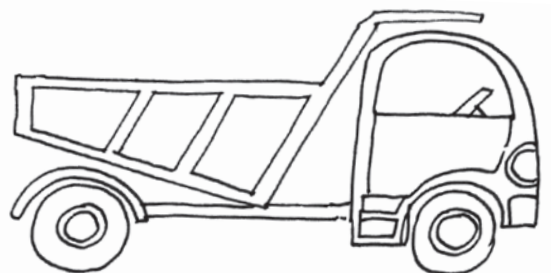
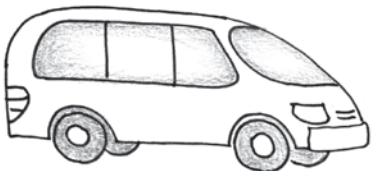

RÄÄGI. ON TEINE.
..... ON KOLMAS.
..... ON ESIMENE.

AUTO+BUSS
VEO+AUTO
SÕIDU+AUTO

VÄRVI KOLMAS SÕIDUK.

MITU? MITMES?

MITU LAST ON REAS? MITU POISSI ON? MITU TÜDRUKUT ON?



RÄÄGI. PIKK POISS ON
LÜHIKE POISS ON
TÜDRUK ON

ESIMENE
TEINE
KOLMAS

VÄRVI. KOLMEL LAPSEL ON SINISED PÜKSID.
KOLMANDAL LAPSEL ON KOLLANE SÄRK.

MITU KASSI ON REAS? MITU VÄIKEST KASSI ON? MITU SUURT KASSI ON?

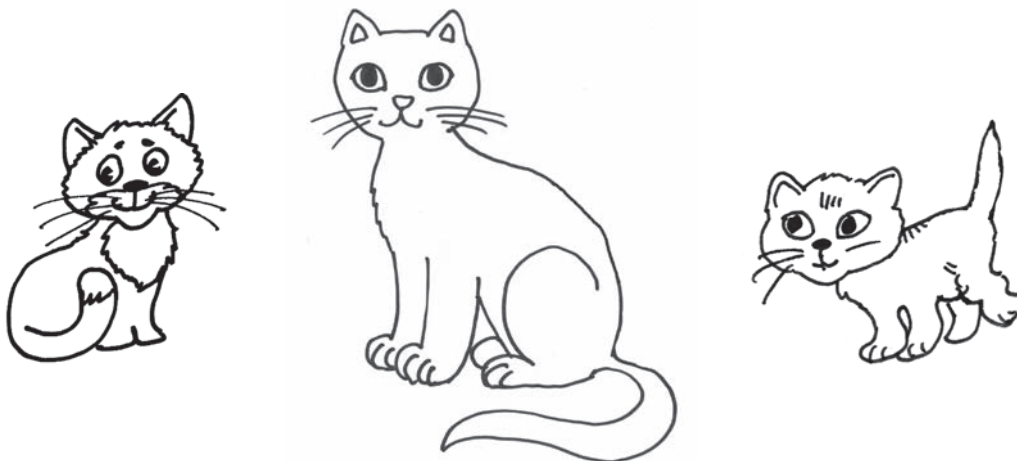

RÄÄGI. ESIMENE KASS ON
TEINE KASS ON
KOLMAS KASS ON

SUUR
VÄIKE

VÄRVI KOLMAS KASS.

MITU PIPAR+KOOKI ON REAS? MITU PIPAR+KOOGI+POISSI ON?
MITU PIPAR+KOOGI+TÜDRUKUT ON?

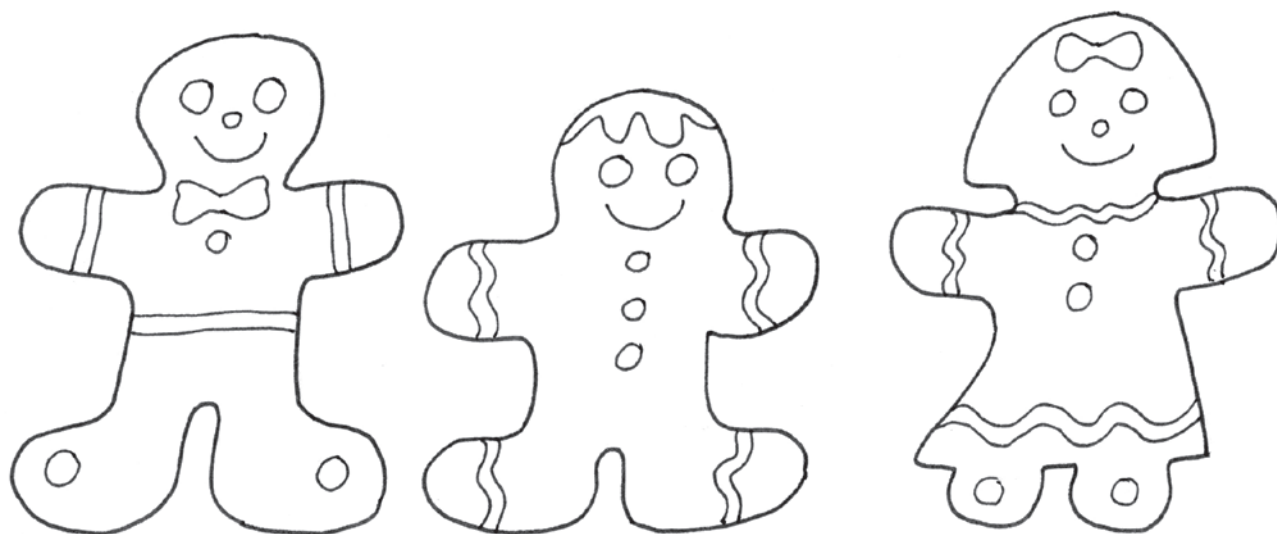

VÄRVI. TEISEL PIPAR+KOOGIL ON KOLLASED NÖÖBID.
ESIMESEL PIPAR+KOOGIL ON ROHELINE NÖÖP.
KOLMANDAL PIPAR+KOOGIL ON PUNASED NÖÖBID.

VÄRVI ESIMENE JA KOLMAS PIPAR+KOOK.

MITU LUME+MEMME ON REAS? MITMES LUME+MEMM ON VÄIKE?



RÄÄGI. LUME+MEMMEL ON KINDAD.
..... LUME+MEMMEL ON TUTI+MÜTS.
..... LUME+MEMMEL ON LUUD.

ESIMESEL
TEISEL
KOLMANDAL

VÄRVI KOLM LUME+MEMME.

RÄÄGI PILTIDE JÄRGI.



OLI ____ . ____ TOOB JUURDE ____ . NÜÜD ON ____ .

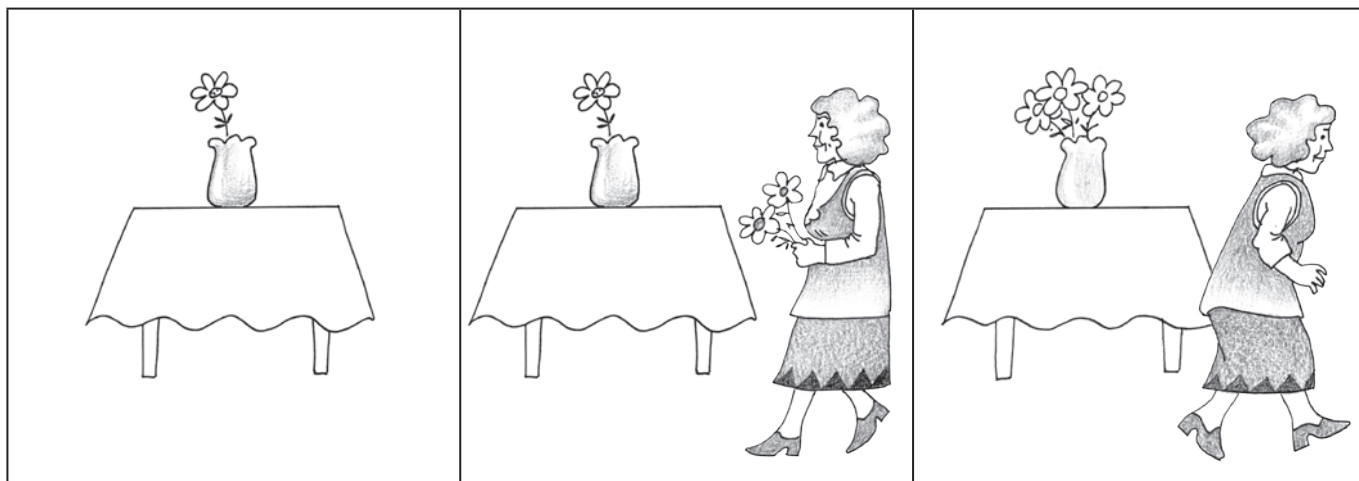

OLI ____ . ____ PANEB JUURDE ____ . NÜÜD ON ____ .

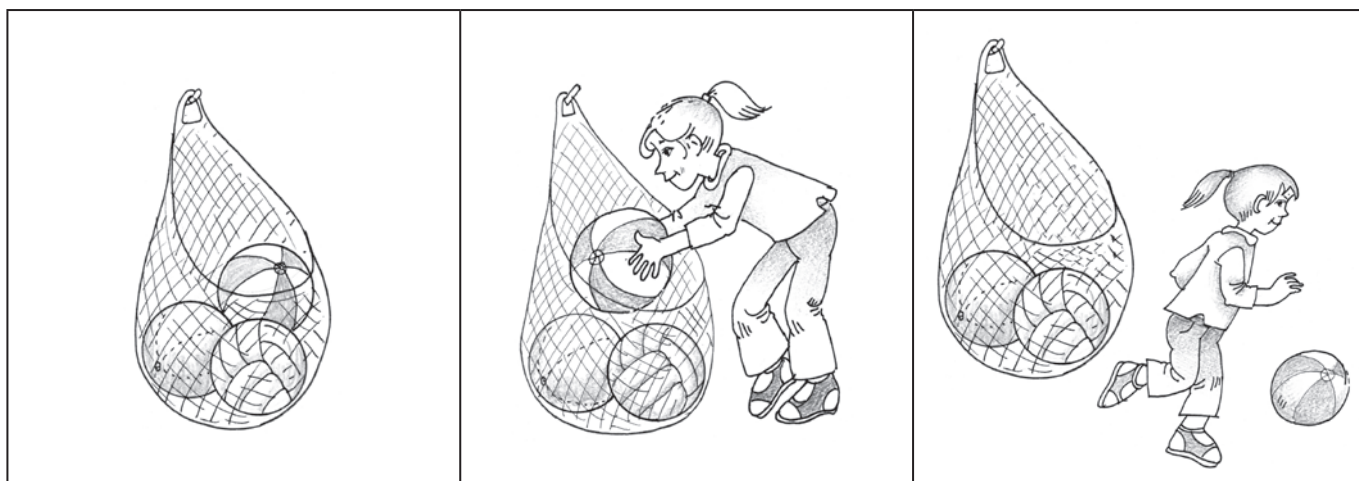

OLI ____ . ____ VÕTAB ÄRA ____ . NÜÜD ON ____ .

RÄÄGI PILTIDE JÄRGI. ARVA ÄRA, MIS ON PILDIL PEIDUS.

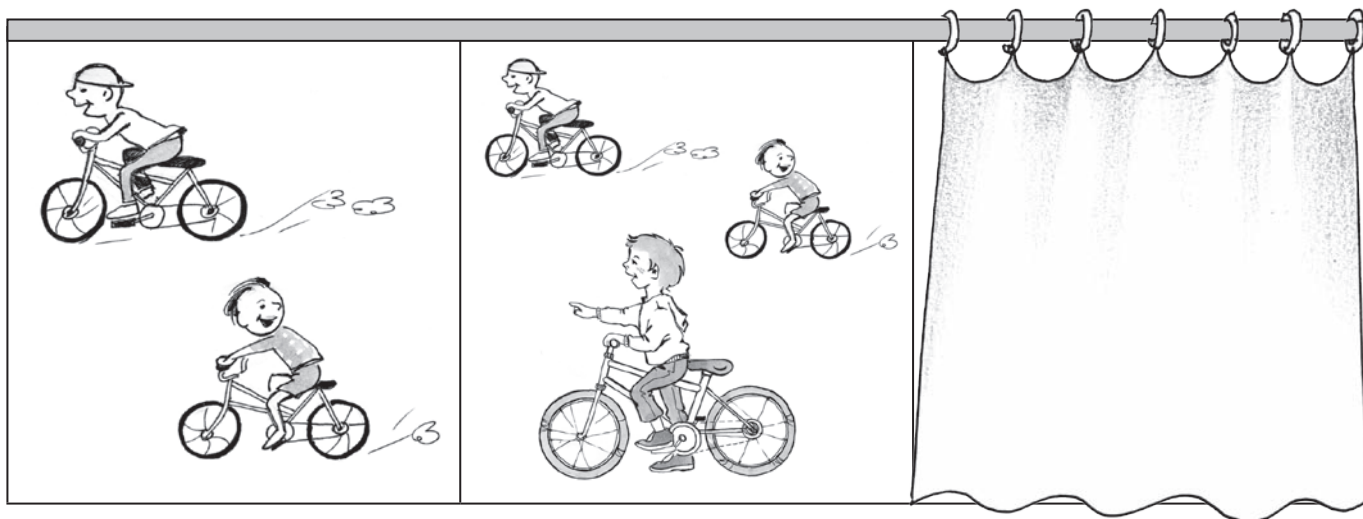

OLI _____ . _____ SÕIDAB JUURDE. NÜÜD ON _____ .

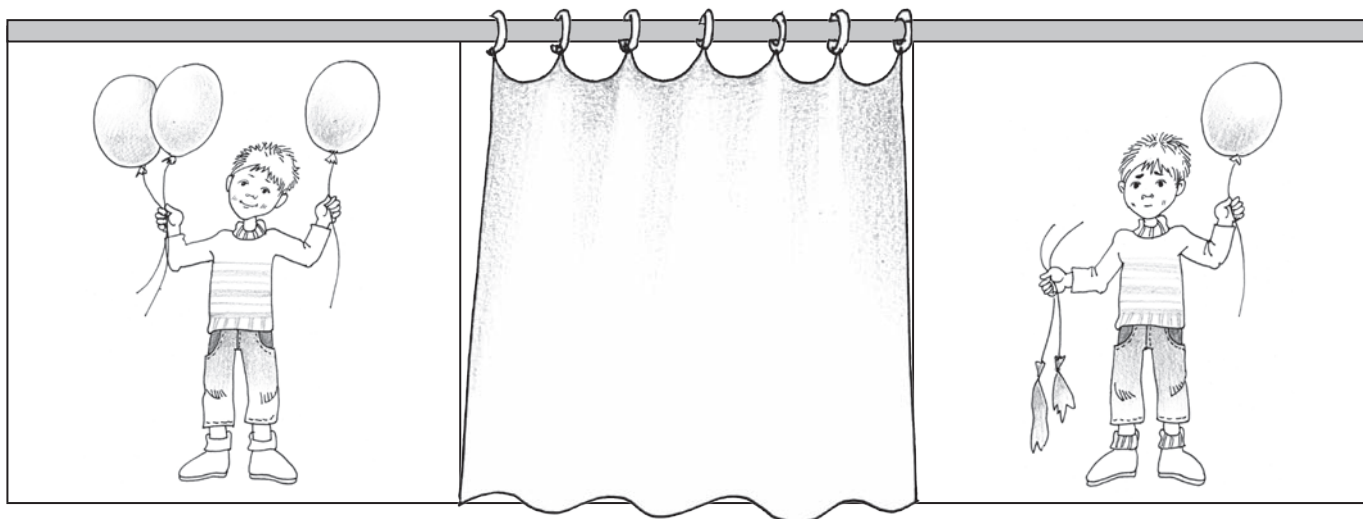

OLI _____ . _____ TEEB KATKI _____ . NÜÜD ON _____ .

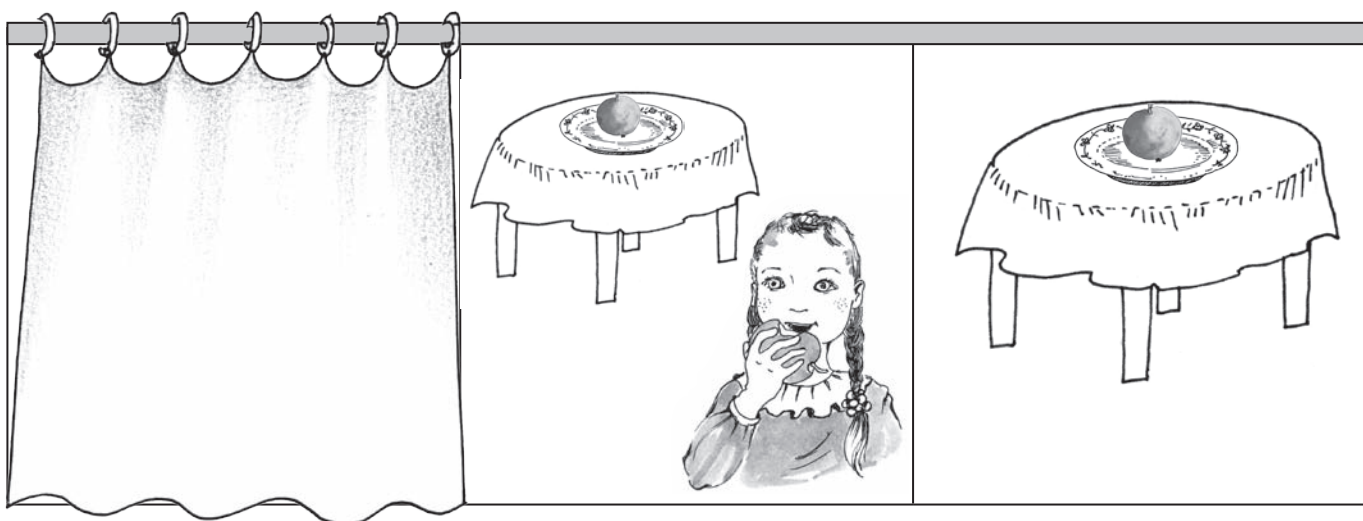

OLI _____ . _____ SÖÖB ÄRA _____ . NÜÜD ON _____ .

4 NELI

1 2 3

4



MIS ON PILDIL? MITU?



VÄRVI NII+SAMA PALJU RUUTE.

ERALDA IGAST HULGAST NELI ESET. VÄRVI NEED.

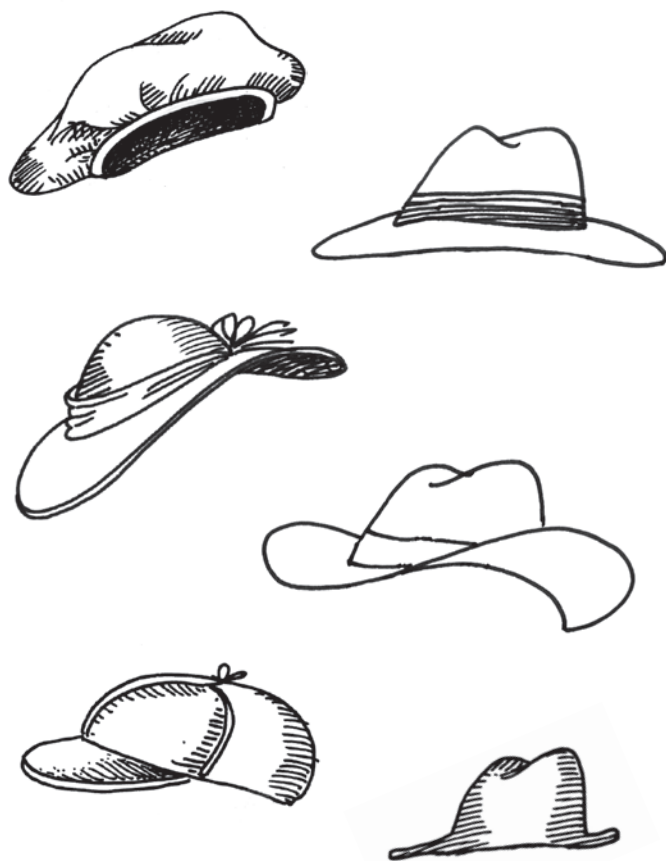

MITU ESET ON HULGAS? TÕMBA ÕIGELE ARVULE RING ÜMBER.

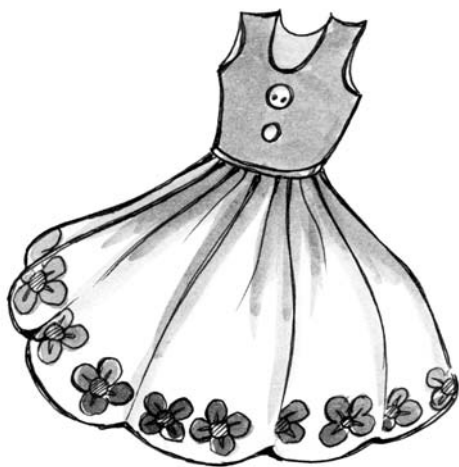

1	2	3	4



1	2	3	4

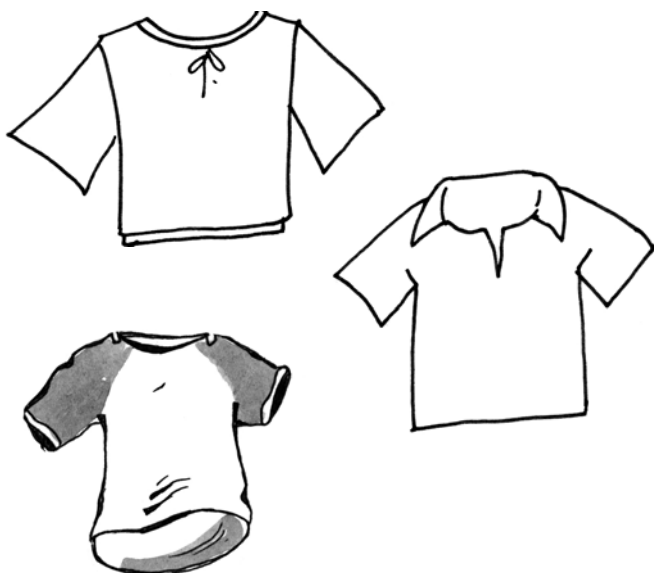

1	2	3	4

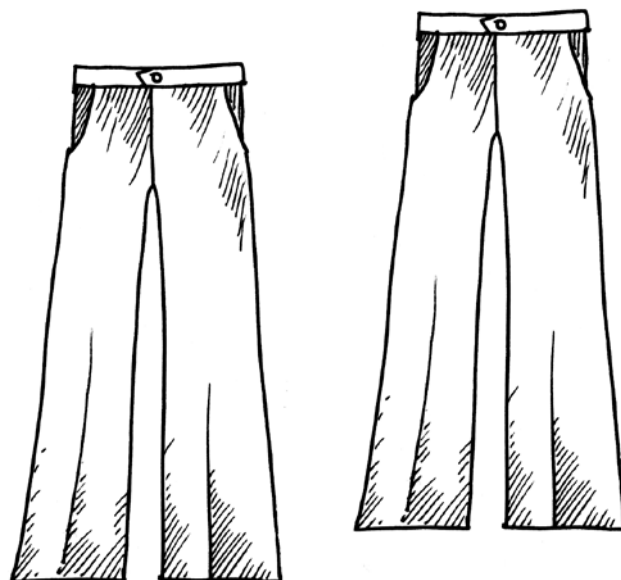

1	2	3	4

VÄRVI HULK, MILLES ON KOLM ESET.

JÄTKA RIDA.

KIRJUTA PUUDUVAD NUMBRID.

2 3 4

LOE ARVU+RIDA. VÄRVI RUUDUD.

KIRJUTA ÕIGE ARV.

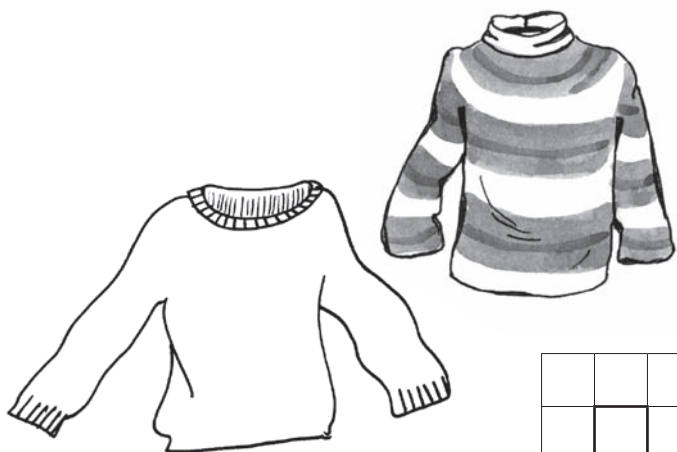

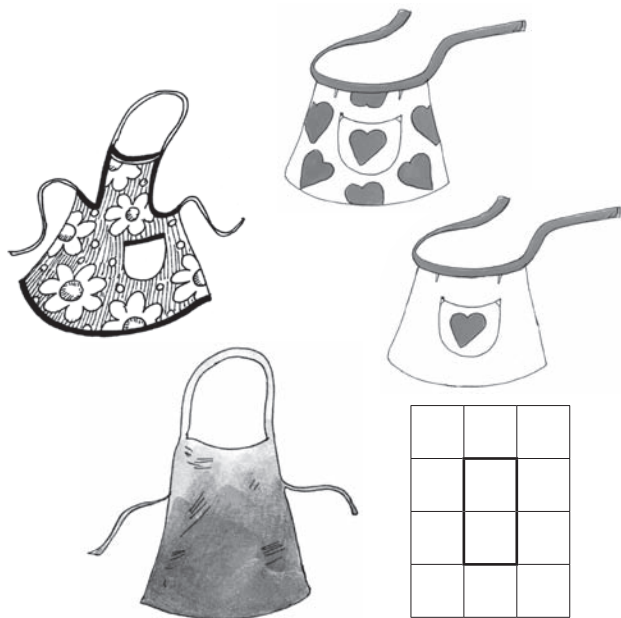

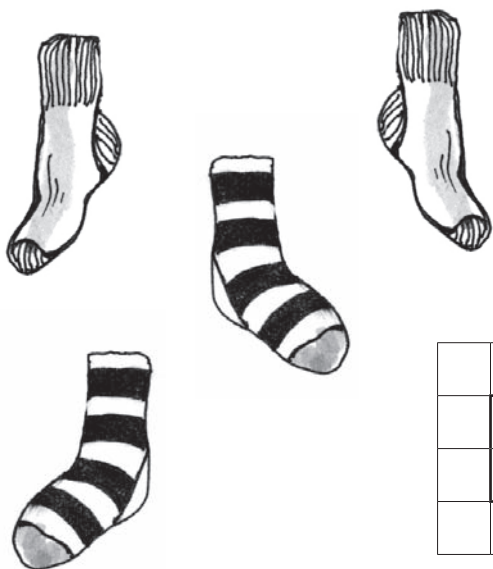



VÄRVI VAJALIK ARV RUUTE.

2

4

4

4

3

4

LEIA VALESTI KIRJUTATUD NUMBRID. PÕHJENDA.

ÕIGESTI KIRJUTATUD NUMBER KIRJUTA ÜLE.

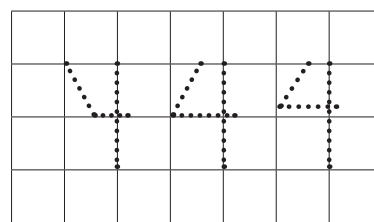
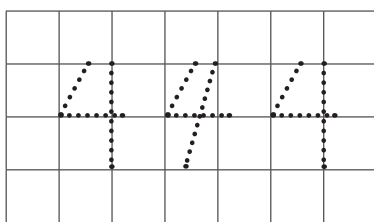
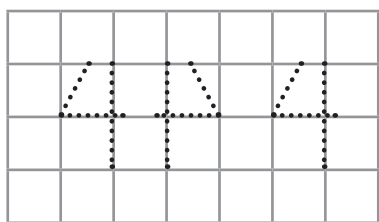

KIRJUTA ÕIGESTI.

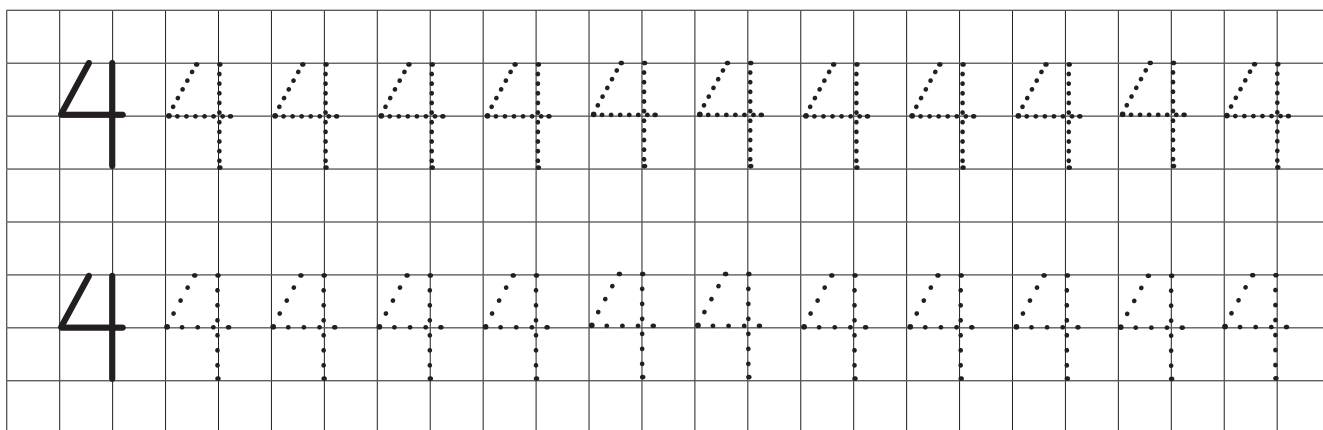

ÜHENDA JOONEGA ARV, SÕNA JA PILT.



NELI

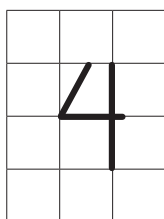
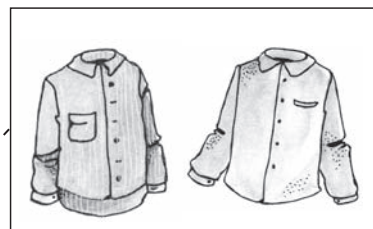

KAKS

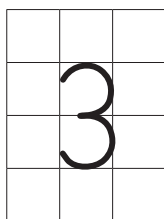

ÜKS

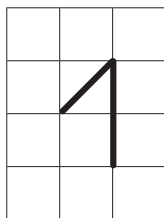
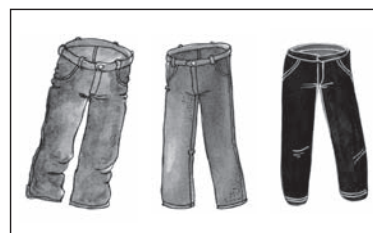

KOLM

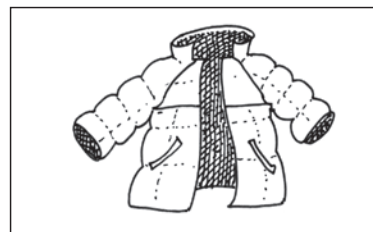

KIRJUTA PUUDUVAD ARVUD.

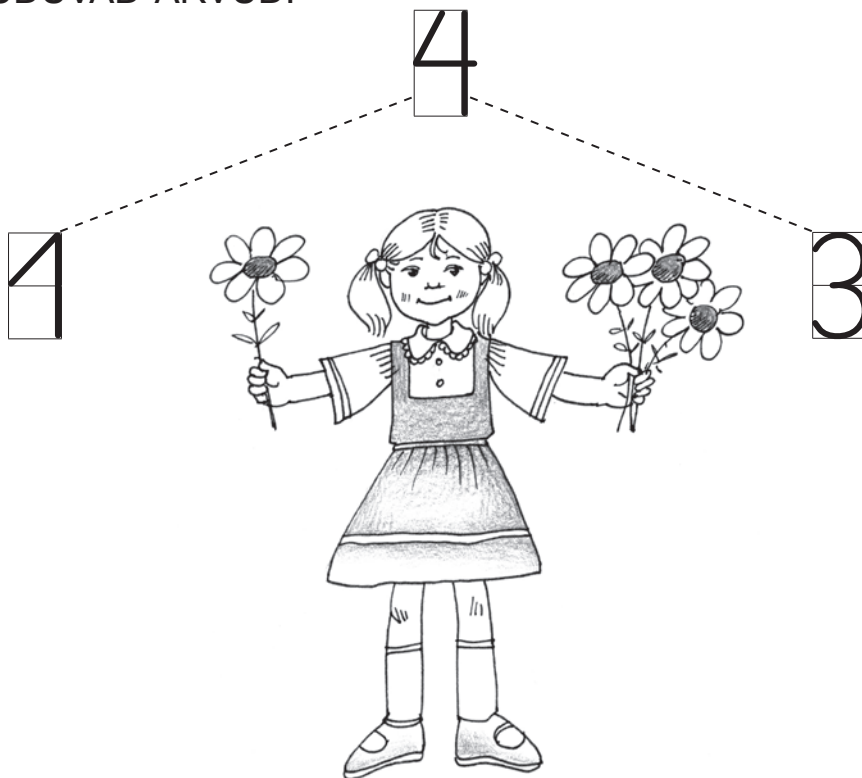

RÄÄGI.

4 ON 4 JA 3

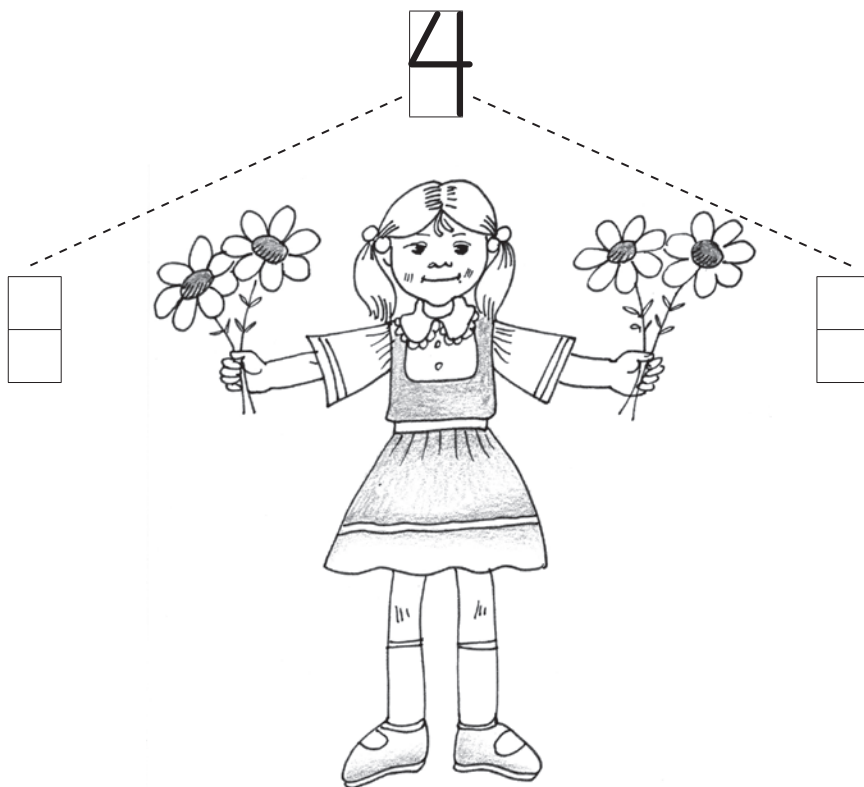

RÄÄGI.

ON JA

JAOTA ESEMED JOONE ABIL. KIRJUTA PUUDUVAD ARVUD. RÄÄGI.

4

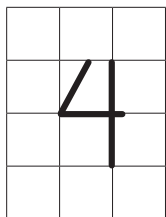

ON

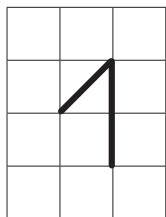

JA

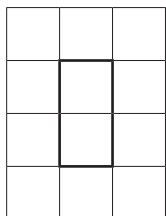
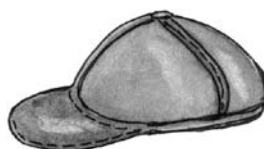
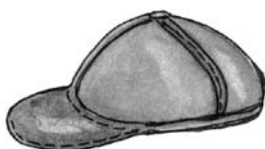
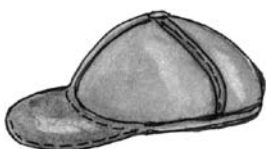
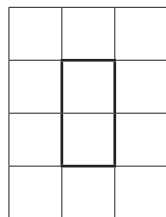

ON

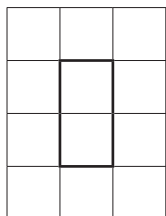

JA

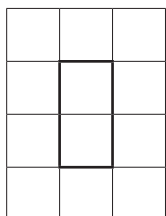

ON

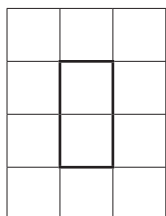

JA

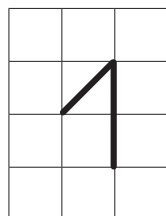

JOONISTA VAJALIK ARV RINGE. RÄÄGI.

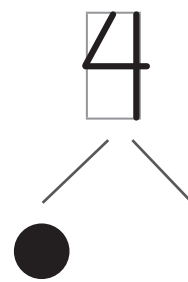
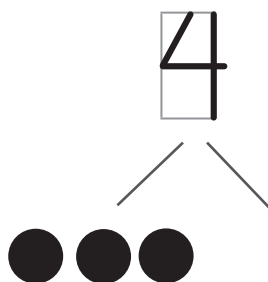
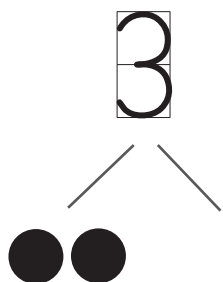
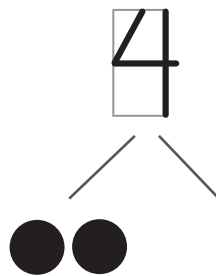
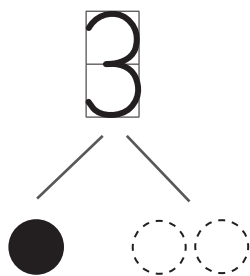

KIRJUTA PUUDUVAD NUMBRID. RÄÄGI.

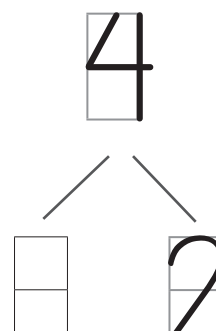
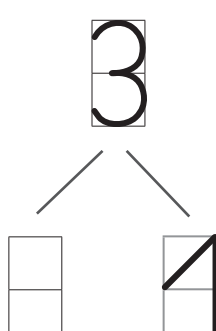
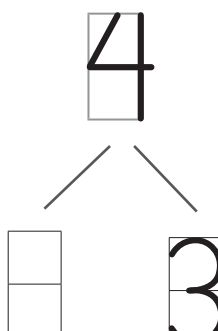
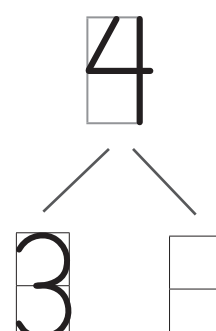
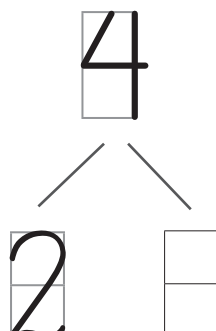
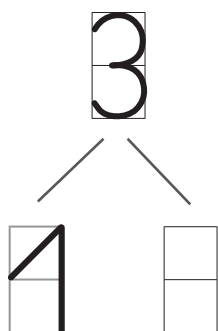

KIRJUTA PUUDUVAD ARVUD.

4

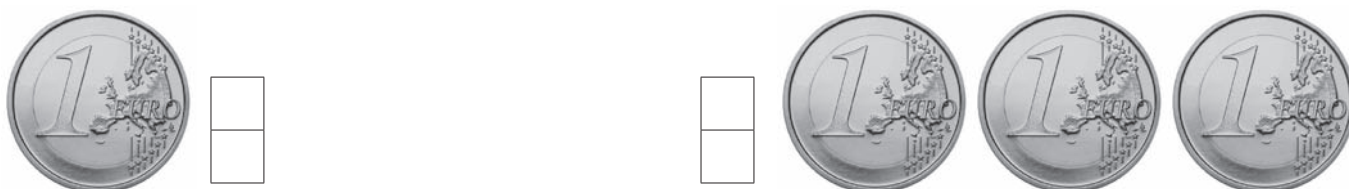
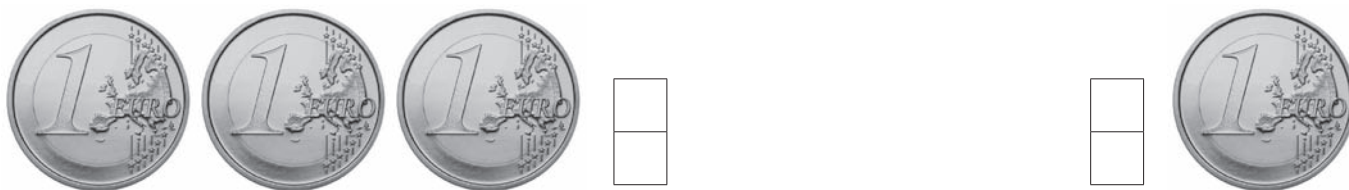
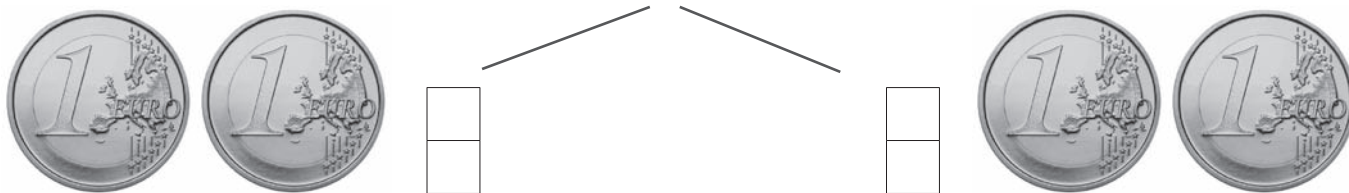

RÄÄGI.

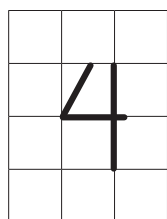

ON

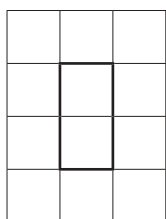

JA

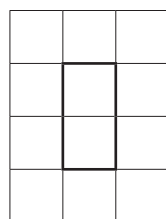

KIRJUTA PUUDUVAD ARVUD.

RÄÄGI.

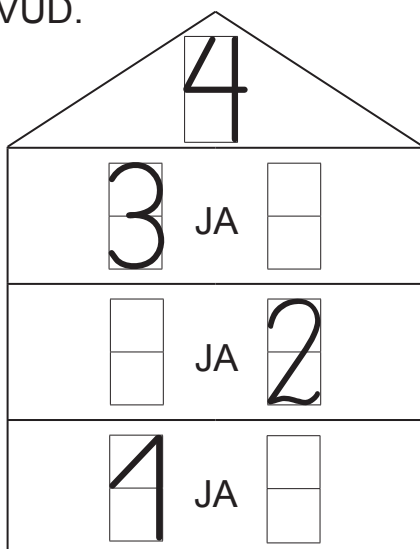

VÖRDLE HULKI JA ARVE. KIRJUTA PUUDUVAD ARVUD JA MÄRGID.

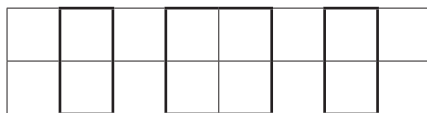
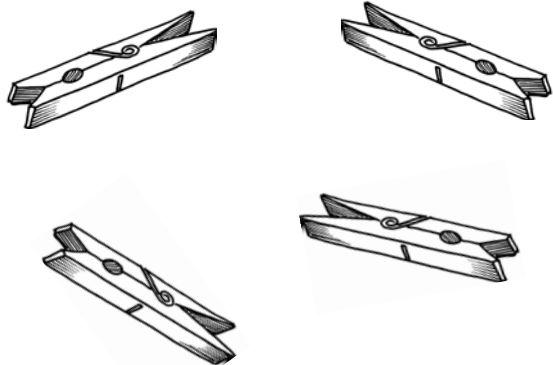
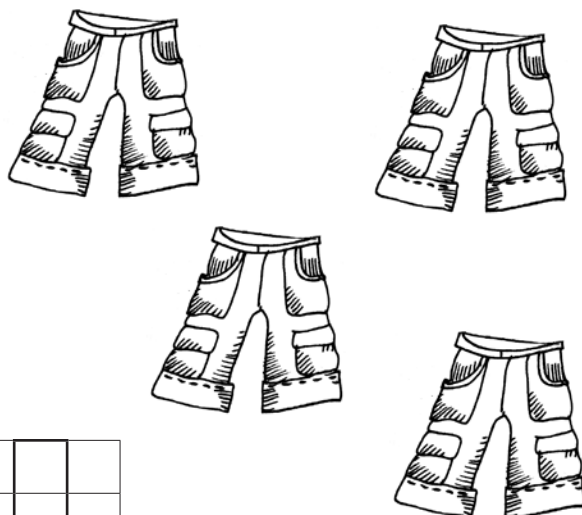
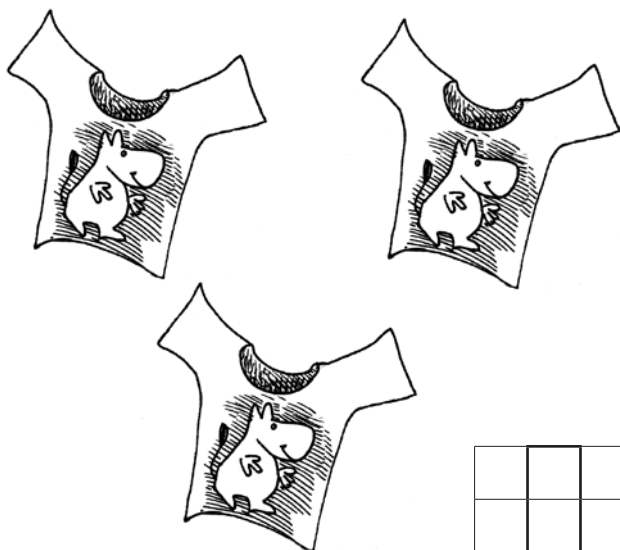
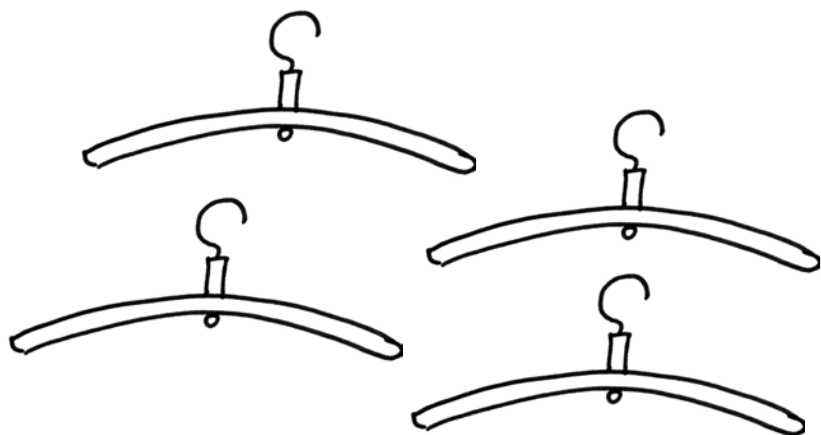

VÖRDLE HULKI JA ARVE. KIRJUTA PUUDUVAD ARVUD JA MÄRGID.

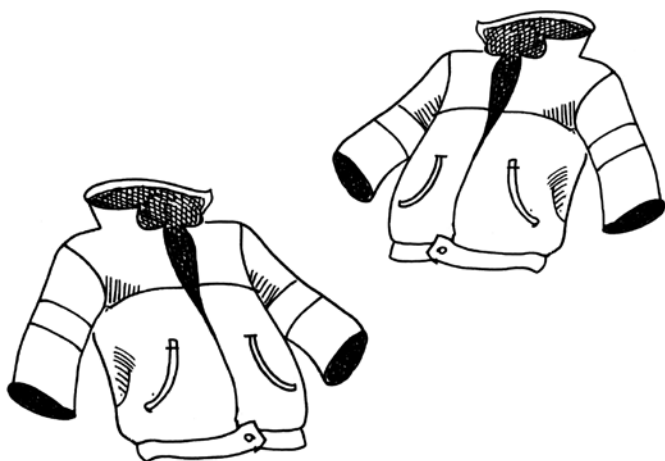

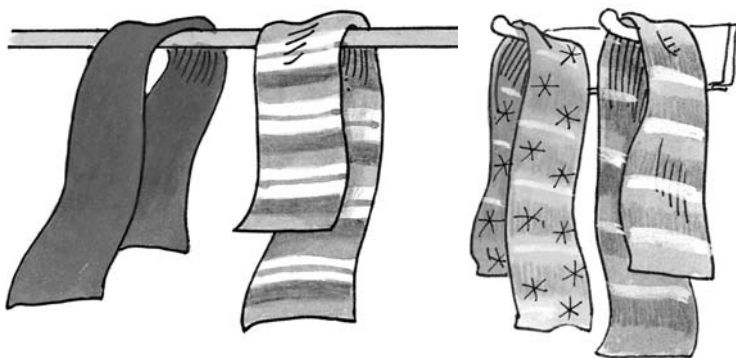

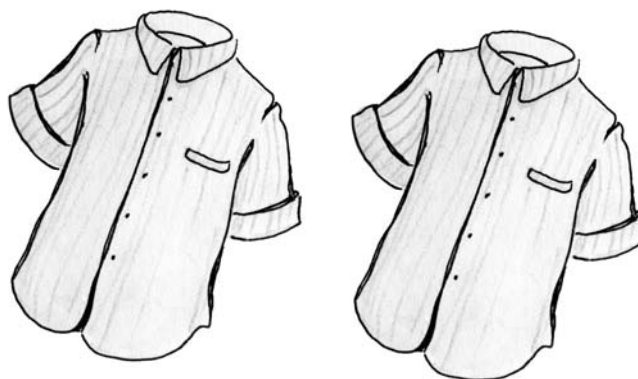
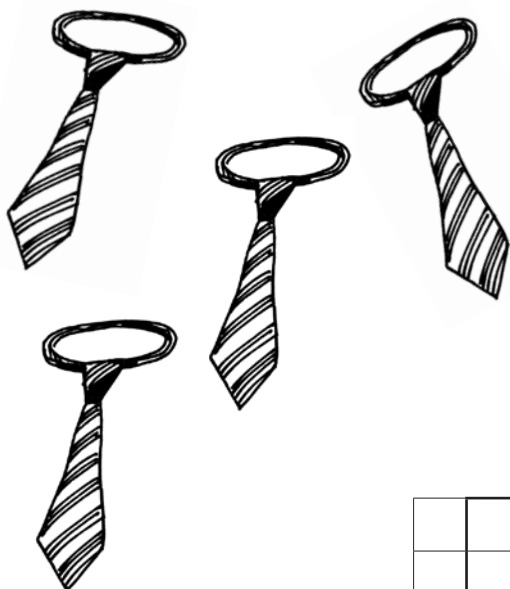

VÄRVI VAJALIK ARV RUUTE. VÖRDLE.

3		4	

2		4	

4		4	

4		4	

3		3	

3		2	

MITU? MITMES?

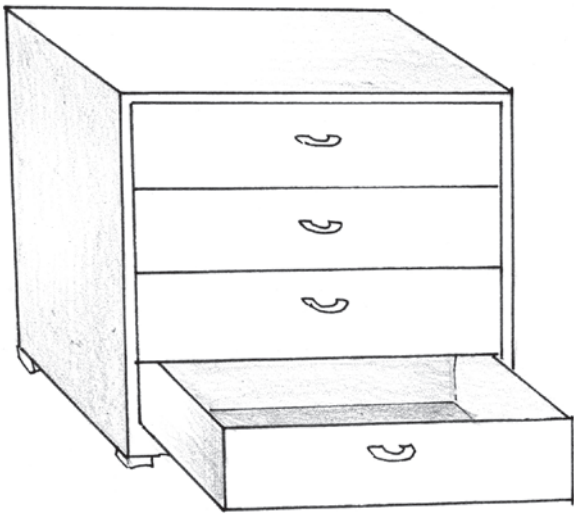

NELJAS

KOLMAS
ESIMENE
TEINE

KIRJUTA PUUDUVAD SÕNAD.

- MITU SAHTLIT KAPIL ON?
- MITU SAHTLIT ON KINNI?
- MITU SAHTLIT ON LAHTI?
- MITMES SAHTEL ON LAHTI?



MITU KLEITI ON?

- RÄÄGI.** KOLMAS KLEIT ON
TEINE KLEIT ON
ESIMENE KLEIT ON
NELJAS KLEIT ON

TRIIBULINE.
RUUDULINE.
TÄPILINE.
LILLELINE.

RÄÄGI PILTIDE JÄRGI. ARVA ÄRA, MIS ON PILDIL PEIDUS.

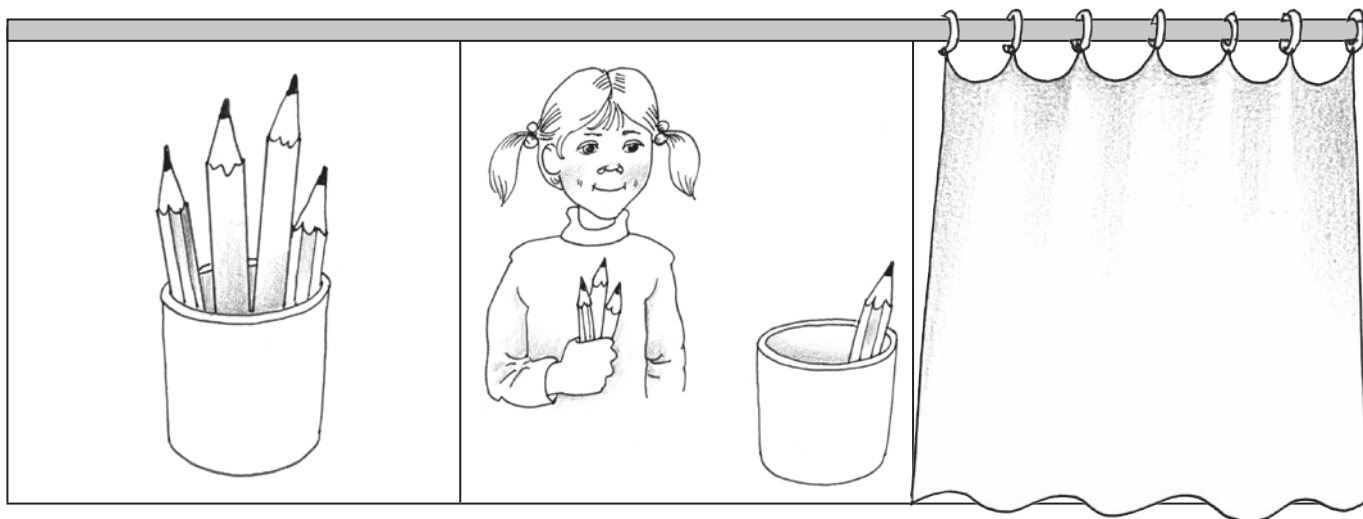

OLI ____ . ____ VÕTAB ÄRA ____ . NÜÜD ON ____ .

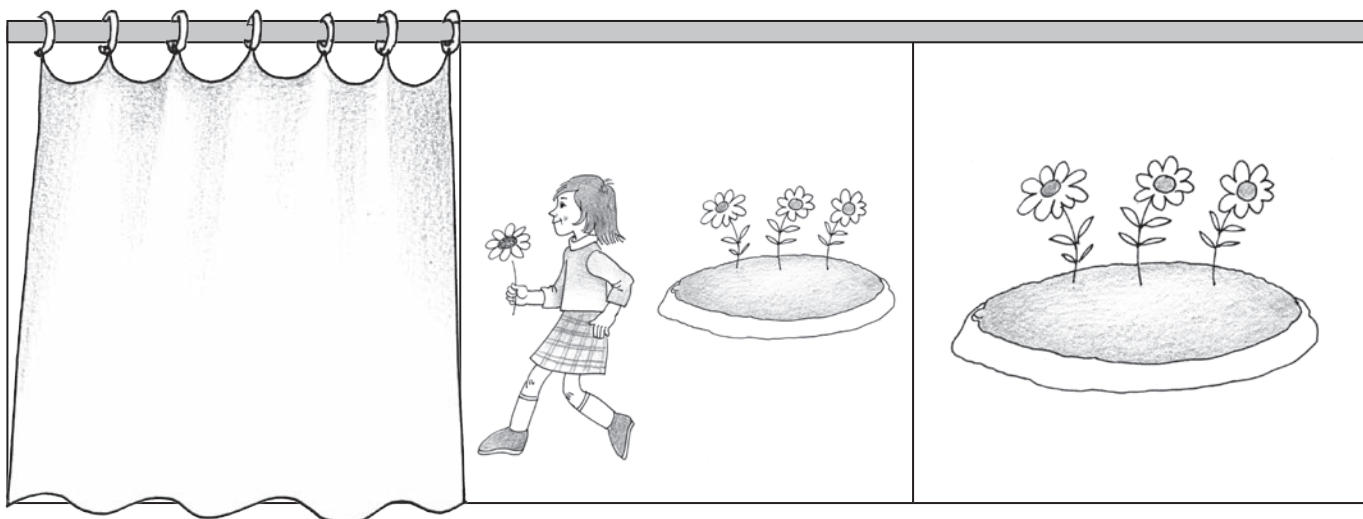

OLI ____ . ____ NOPIB ÄRA ____ . NÜÜD ON ____ .

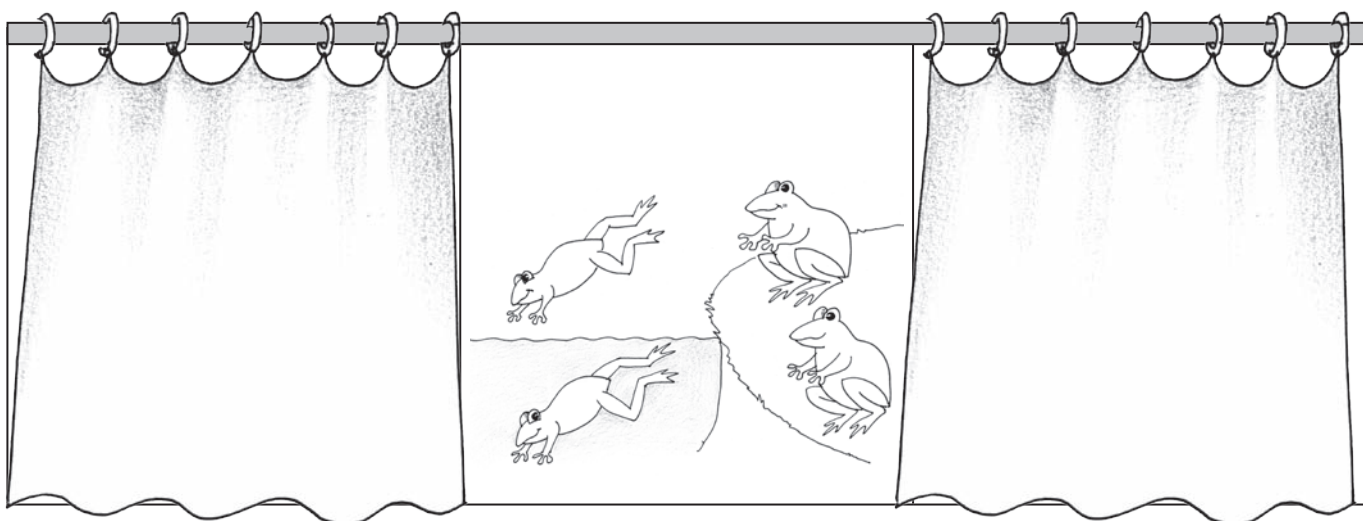

OLI ____ . ____ HÜPPAB VETTE. NÜÜD ON ____ .

KEVAD SUVI SÜGIS TALV

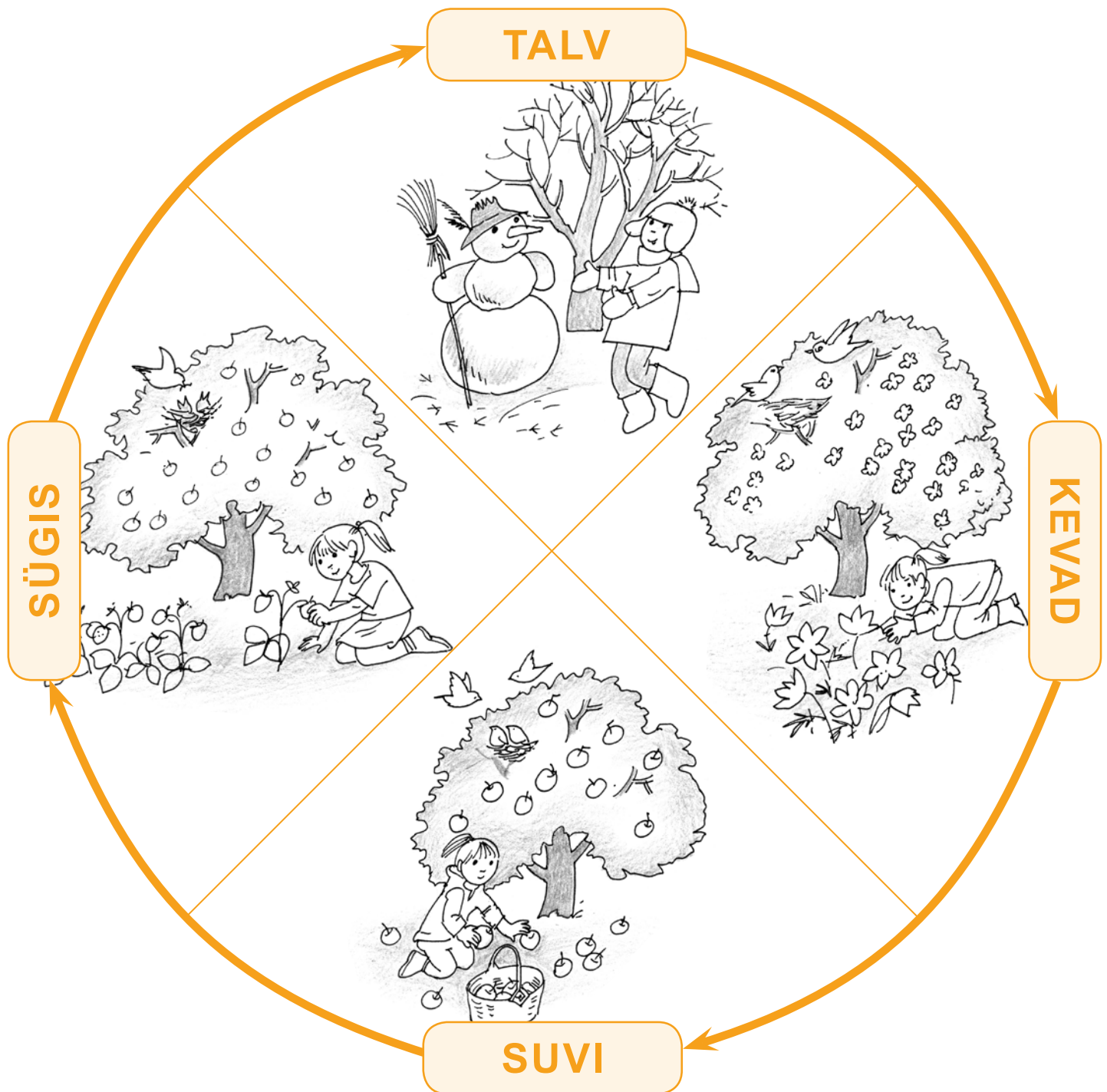

MITU AASTA+AEGA MEIL ON?

NIMETA JÄRJE+KORRAS KÕIK AASTA+AJAD.

MIS AASTA+AEG ON PRAEGU?

MIS AASTA+AEG TULEB VARSTI?

MIS AASTA+AJAL PILDISTATI PEEPU?

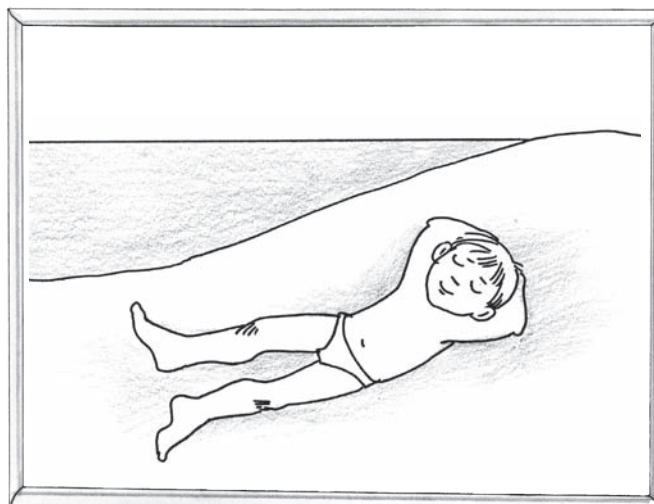

VÄRVI. SUVEL OLID PEEBUL JALAS KOLLASED PÜKSID.
TALVEL OLID PEEBUL JALAS PUNASED PÜKSID.

MIS AASTA+AJAL PILDISTATI ANU?



VÄRVI. SÜGISEL OLID ANUL JALAS PRUUNID SAAPAD.
KEVADEL OLID ANUL JALAS SINISED SAAPAD.

PIIRA JOONEGA SUUR KINGI+PAKK. **PIIRA** JOONEGA VÄIKESED KINGI+PAKID. **PIIRA** PAKID JOONEGA.

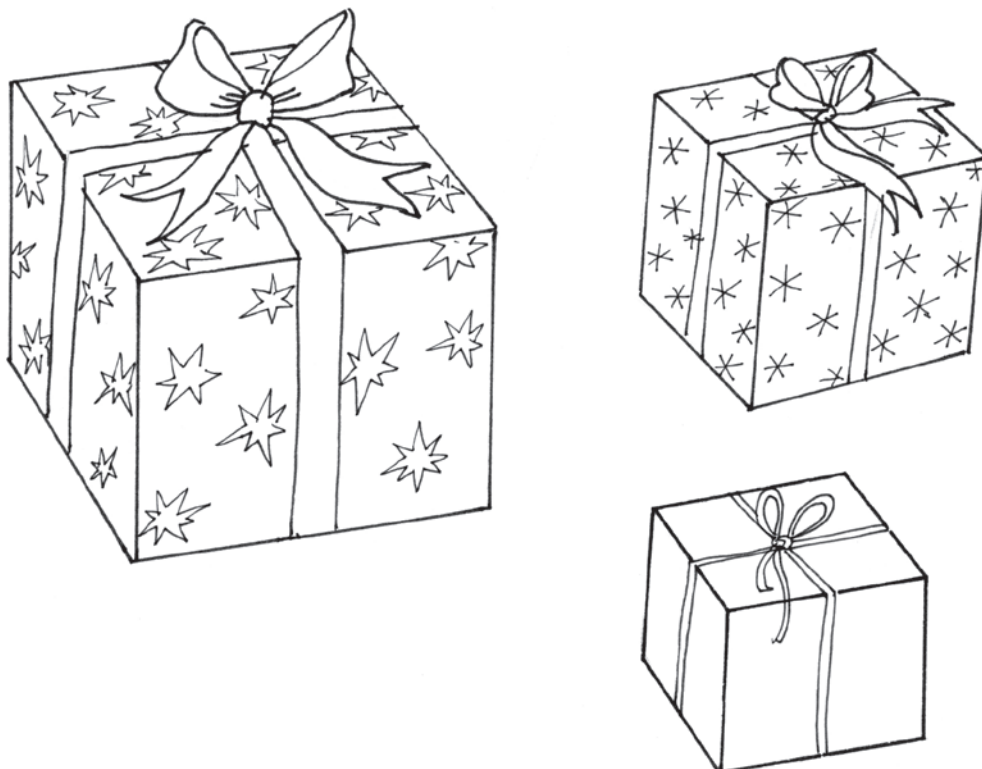

PIIRA JOONEGA KINGADE HULK. **PIIRA** JOONEGA SAABASTE HULK. **PIIRA** JOONEGA JALA+NÕUDE HULK.



RÄÄGI. PILDIL ON KINGA.
PILDIL ON SAABAST.
PILDIL ON JALATSIT.

ÜKS
KAKS
KOLM
NELI

PIIRA JOONEGA PASTA+PLIIATSID. **PIIRA** JOONEGA VÄRVI+PLIIATS.
PIIRA JOONEGA KÕIK PIIATSID. **KIRJUTA** PUUDUVAD ARVUD.

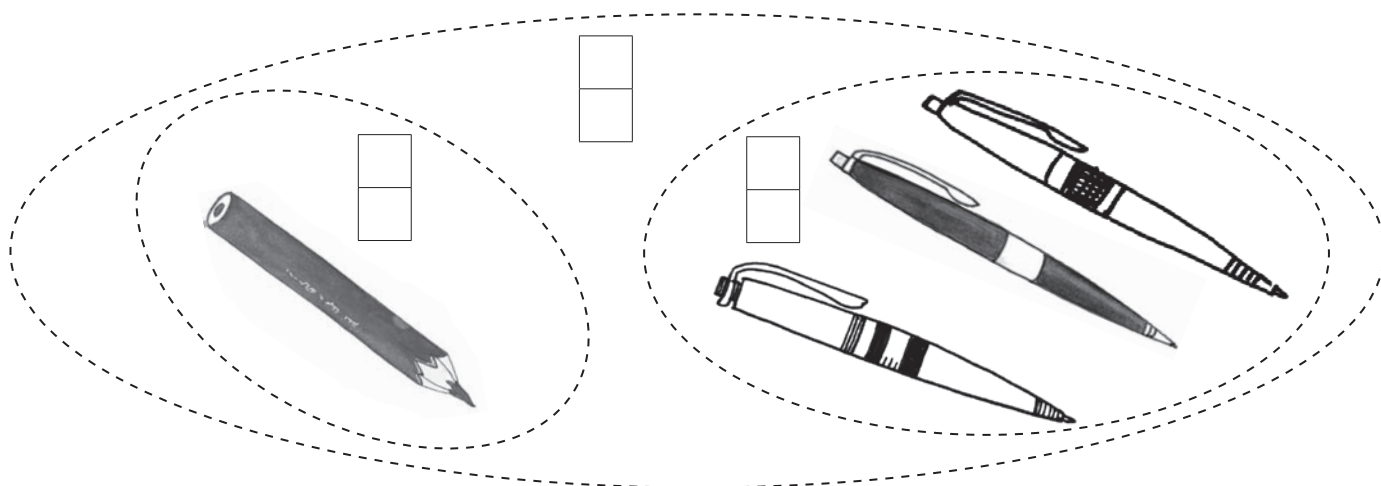

RÄÄGI. PILDIL ON VÄRVI+PLIIATS.
 PILDIL ON PASTA+PLIIATSIT.
 PILDIL ON KOKKU PIIATSID.

ÜKS
 KAKS
 KOLM
 NELI

PIIRA JOONEGA JALG+RATASTE HULK. **PIIRA** JOONEGA AUTODE HULK.
PIIRA JOONEGA SÕIDU+VAHENDITE HULK. **KIRJUTA** PUUDUVAD ARVUD.

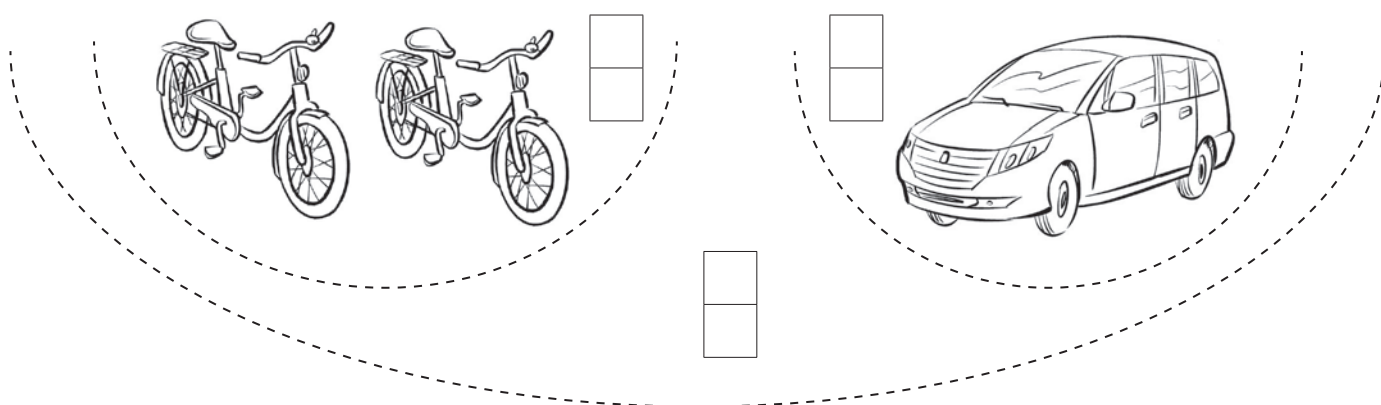

RÄÄGI. PILDIL ON AUTO.
 PILDIL ON JALG+RATAST.
 PILDIL ON SÕIDUKIT.

ÜKS
 KAKS
 KOLM
 NELI

PIIRA JOONEGA ÜHESUGUSED ESEMED. ÜHENDA HULGAD.

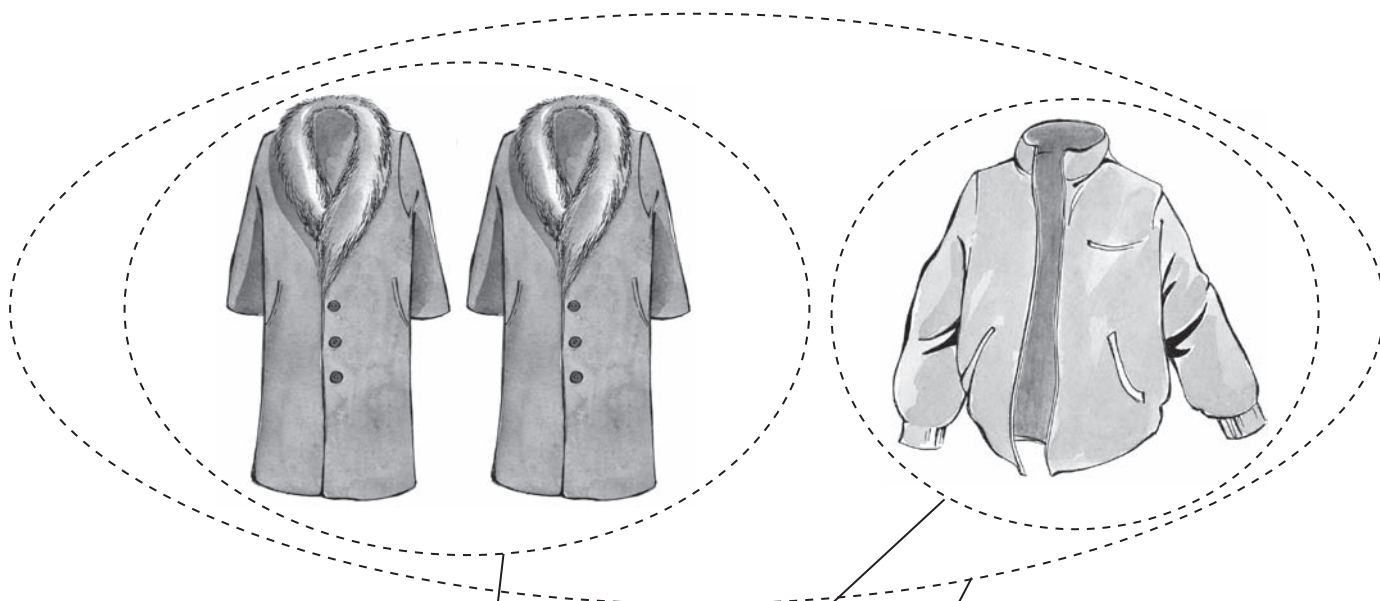

2	+	1	=	3
---	---	---	---	---

+ ON LIITMIS+MÄRK.

LOE LIITMIS+ÜLESANNET NII:

2	+	1	=	3
---	---	---	---	---

KAKS **PLUSS** ÜKS **ON** KOLM.

JÄTKA RIDA.

+	+	+	+	+	+	+	+	+	+	+	+	+
+	+	+	+	+	+	+	+	+	+	+	+	+

ÜHENDA HULGAD. KIRJUTA PILDI JÄRGI LIITMIS+ÜLESANNE.

ARVUTA. LOE.

		+		=		

		+		=		

		+		=		

		+		=		

		+		=		

		+		=		

		+		=		

		+		=		

JOONISTA LIITMIS+ÜLESANDE JÄRGI VAJALIK ARV KUJUNDEID.

ÜHENDA HULGAD JOONEGA. ARVUTA. LOE.

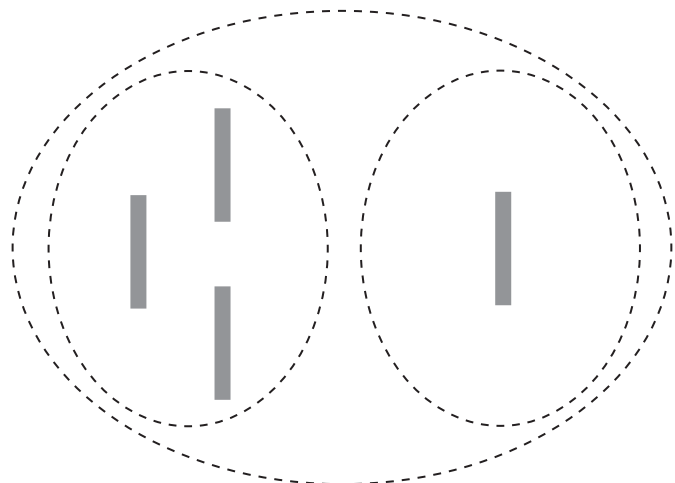

$$3 + 1 = \square$$

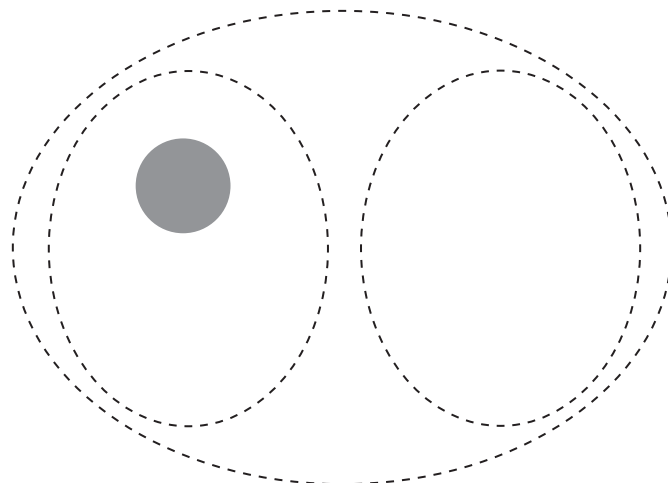

$$2 + 1 = \square$$

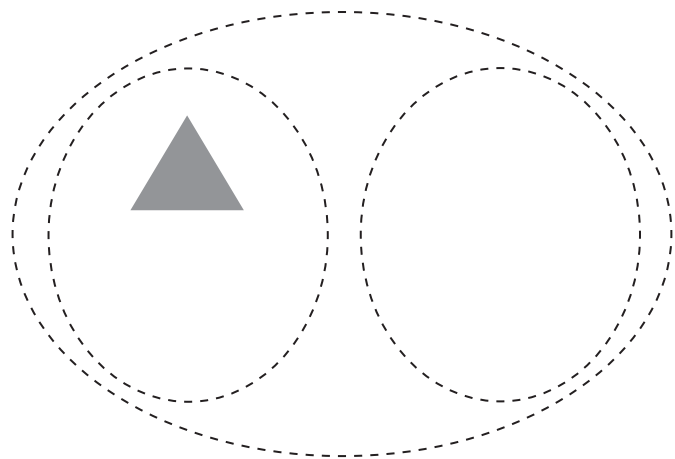

$$2 + 2 = \square$$

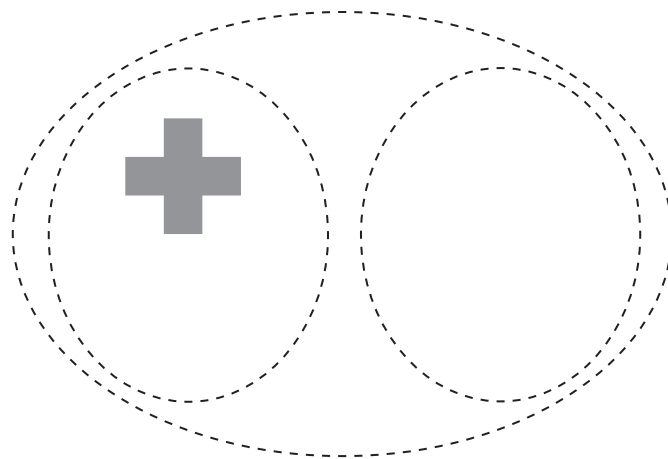

$$1 + 1 = \square$$

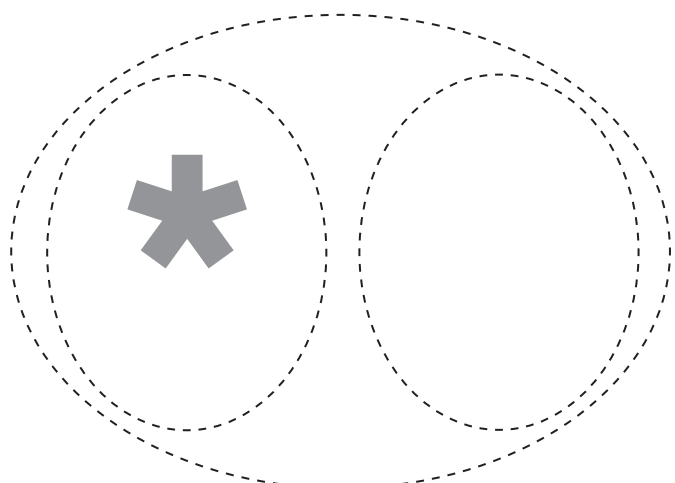

$$1 + 2 = \square$$

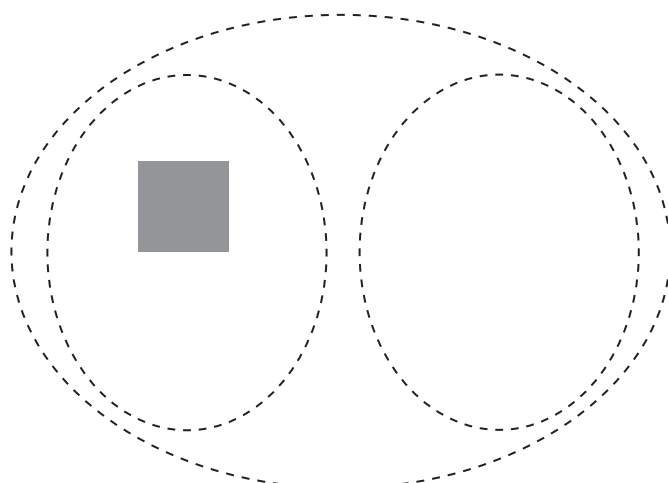

$$1 + 3 = \square$$

JOONISTA VAJALIK ARV KRIIPSE. ÜHENDA HULGAD. ARVUTA. LOE.

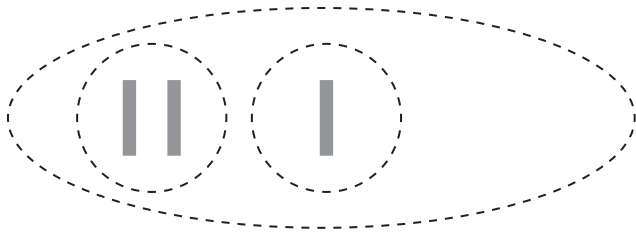

$$2 + 1 = \square$$



$$3 + 1 = \square$$

$$2 + 2 = \square$$

$$1 + 1 = \square$$

$$1 + 2 = \square$$

$$1 + 3 = \square$$

ARVUTA JA VÄRVI (= 2 SININE, = 3 ROHELINE, = 4 KOLLANE).

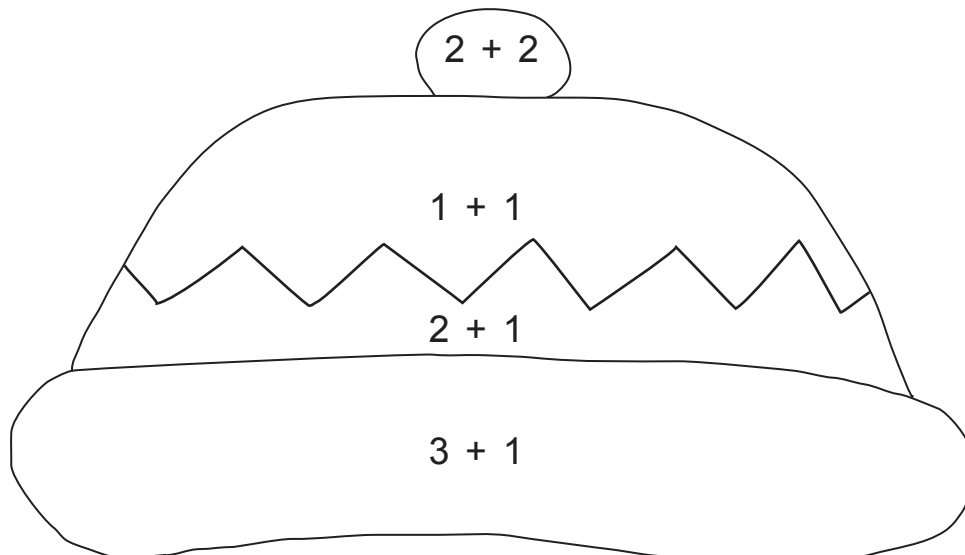

KIRJUTA PILDID JÄRGI LIITMIS+ÜLESANNE. LOE.

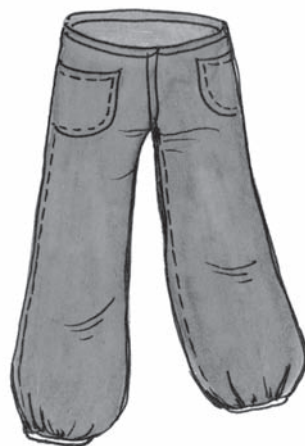
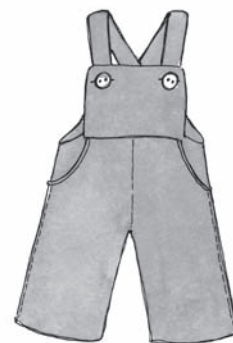
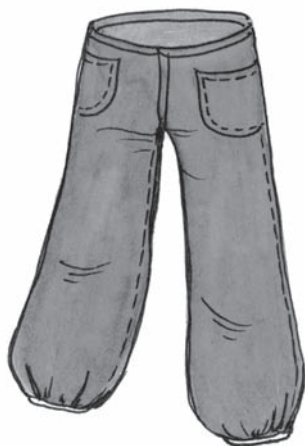
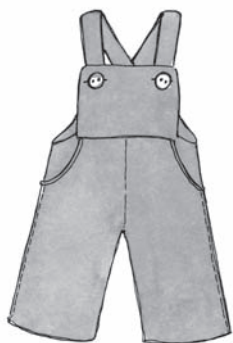

		+		=		

		+		=		

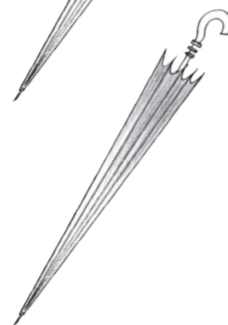
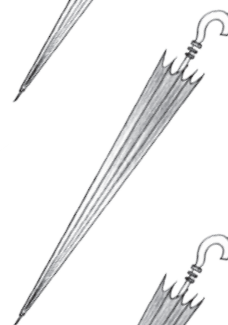
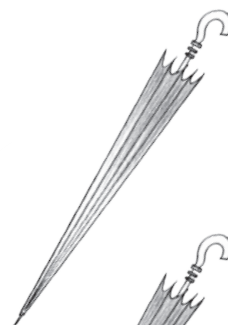
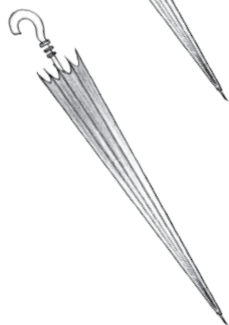
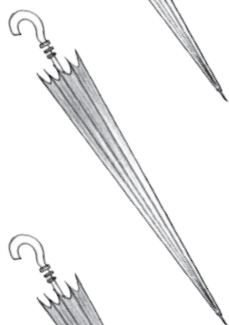
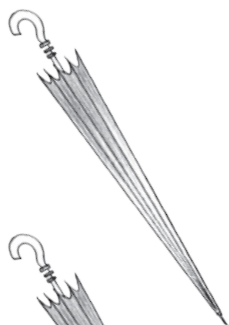

		+		=		

		+		=		

ÜHENDA JOONEGA SARNASED PILDID.

VÄRVI LILLED SARNASTEL PILTIDEL SAMA VÄRVIGA.

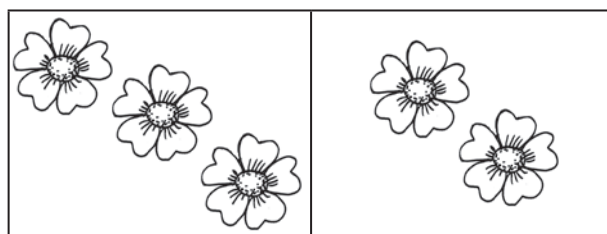
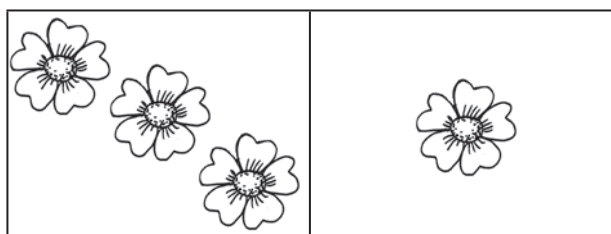
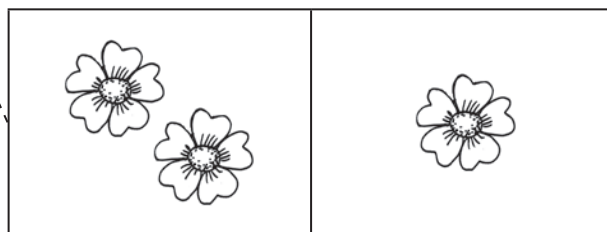
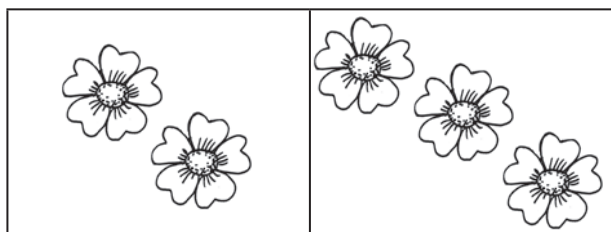
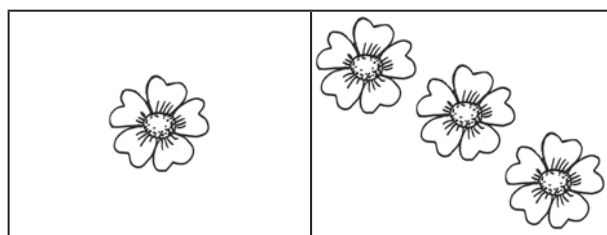
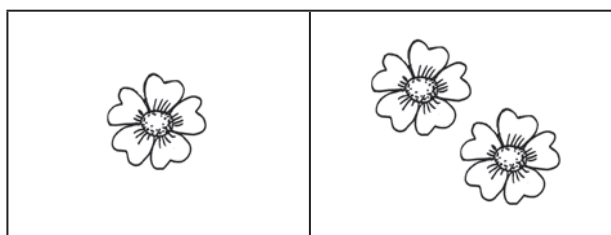

ARVUTA. ÜHENDA JOONEGA SARNASED ÜLESANDED.

LOE SARNASED ÜLESANDED.



$$3 + 1 = \square$$

$$2 + 1 = \square$$

$$1 + 2 = \square$$

$$1 + 1 = \square$$

$$2 + 2 = \square$$

$$1 + 3 = \square$$

KIRJUTA PILDID JÄRGI KAKS LIITMIS+ÜLESANNET.

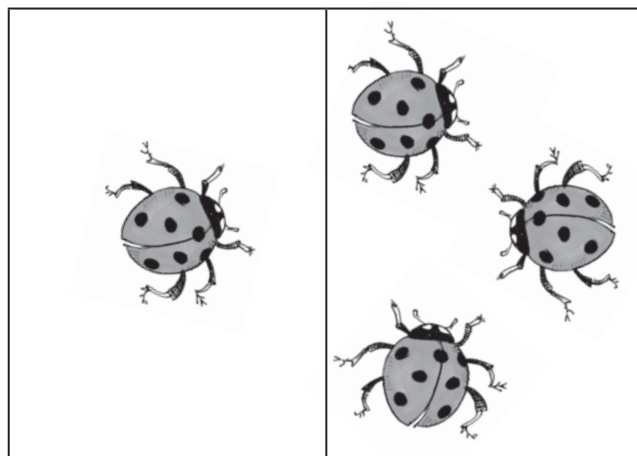
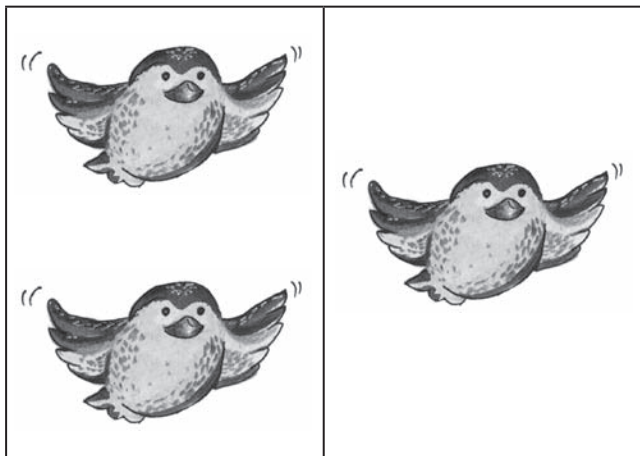

2	+	1	=	□
1	+	2	=	□

□	+	□	=	□
□	+	□	=	□

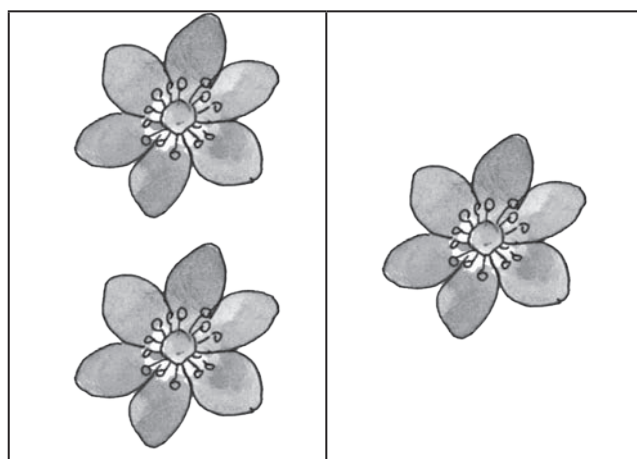
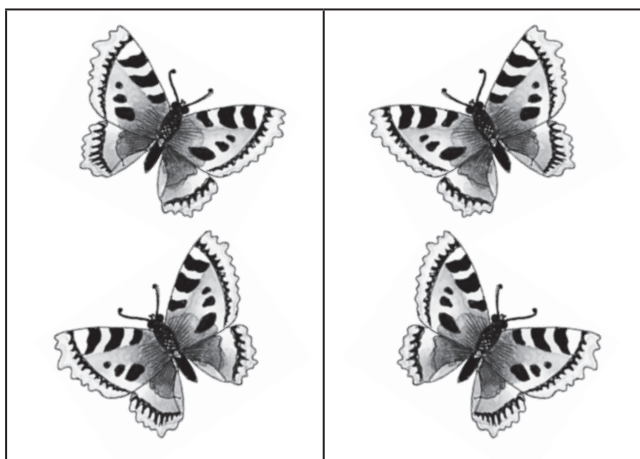

□	+	□	=	□
□	+	□	=	□

□	+	□	=	□
□	+	□	=	□

KIRJUTA ÜLESANNE VIHIKUSSE. ARVUTA.

$1 + 1$

$2 + 1$

$3 + 1$

$2 + 2$

$1 + 2$

$1 + 3$

ARVUTA. ÜHENDA JOONEGA ÜLESANNE JA SOBIV VAGUN.

VÄRVI NEED SAMA VÄRVIGA.

$2 + 1$

$3 + 1$

$1 + 1$

$2 + 2$

$1 + 2$

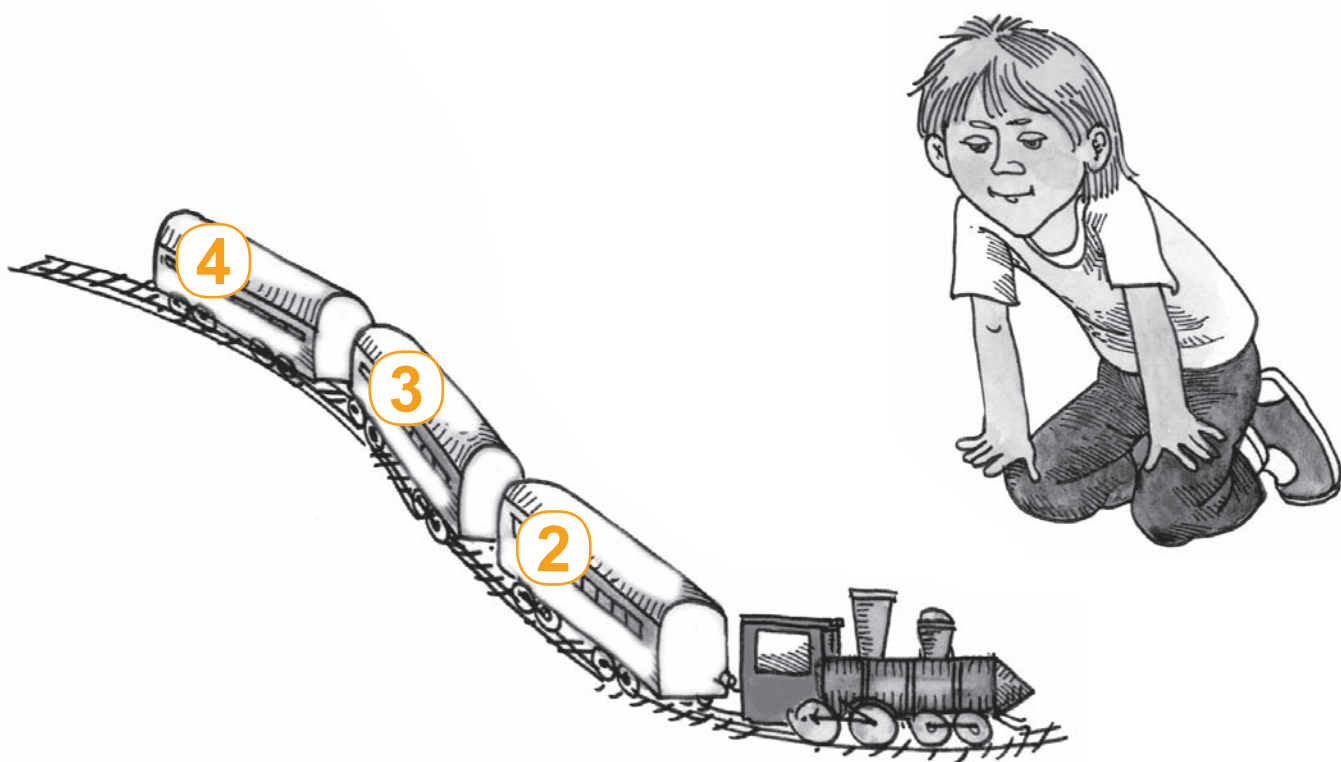

MITU POISSI OLI? MITU POISSI SÕIDAB JUURDE? MITU POISSI NÜÜD ON?

OLI ____ . ____ SÕIDAB JUURDE. NÜÜD ON ____ .

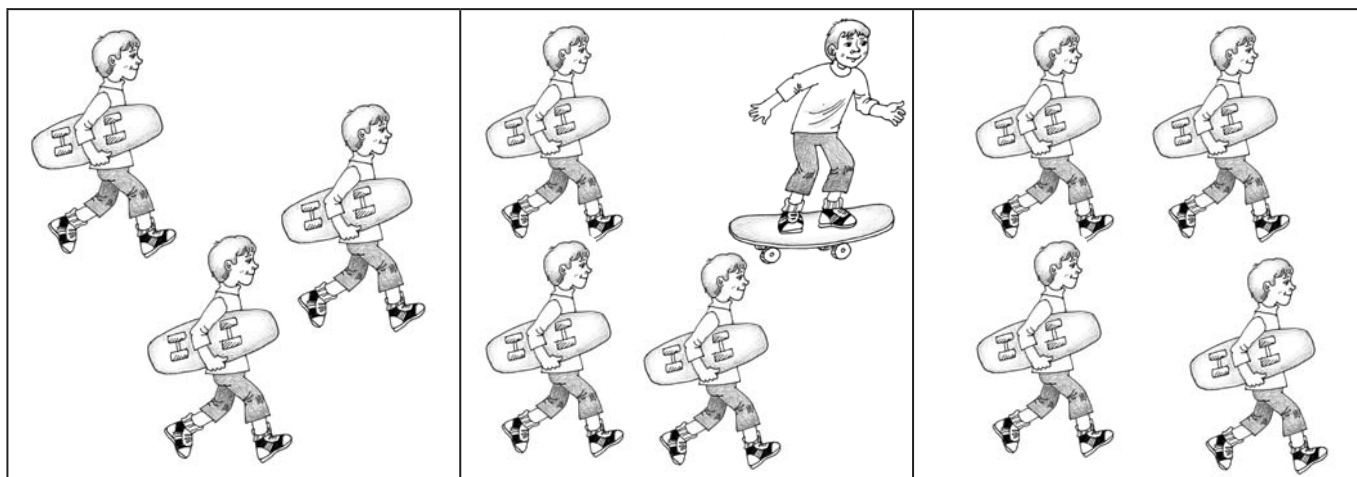

POISSI

+ POISS

= POISSI

MITU _____?

MITU _____?

MITU _____?

OLI ____ .

_____ PANEB JUURDE ____ .

NÜÜD ON ____ .

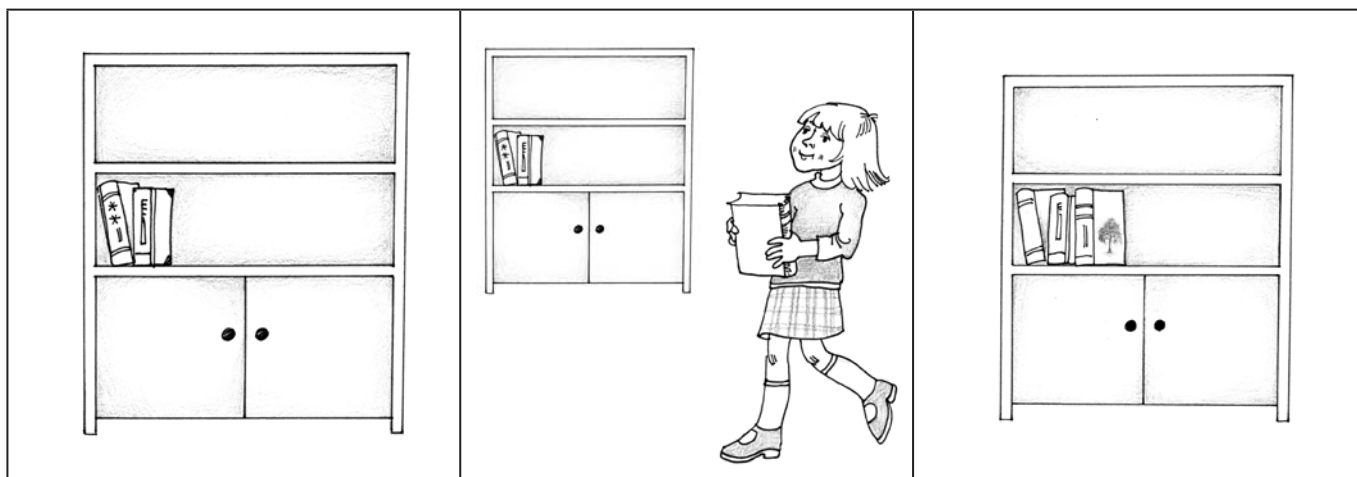

RAAMATUT

+ RAAMAT

= RAAMATUT

MÕTLE IGA PILDI KOHTA KÜSIMUS. **KOOSTA** LIITMIS+ÜLESANNE.

KIRJUTA PUUDUVAD NUMBRID. **LOE** ÜLESANDE LAHENDUS.

OLI _____ . _____ PANEB JUURDE _____ . NÜÜD ON _____ .

1 NUKKU + 2 NUKK = 3 NUKKU

OLI _____ . _____ SÕIDAB JUURDE. NÜÜD ON _____ .

1 AUTOT + 2 AUTOT = 3 AUTOT

MÕTLE PEIDETUD PILDI KOHTA KÜSIMUS.

KOOSTA TEKST+ÜLESANNE. **KIRJUTA** PUUDUVAD NUMBRID.

LOE ÜLESANDE LAHENDUS.

5 VIIS

1 2 3 4

5

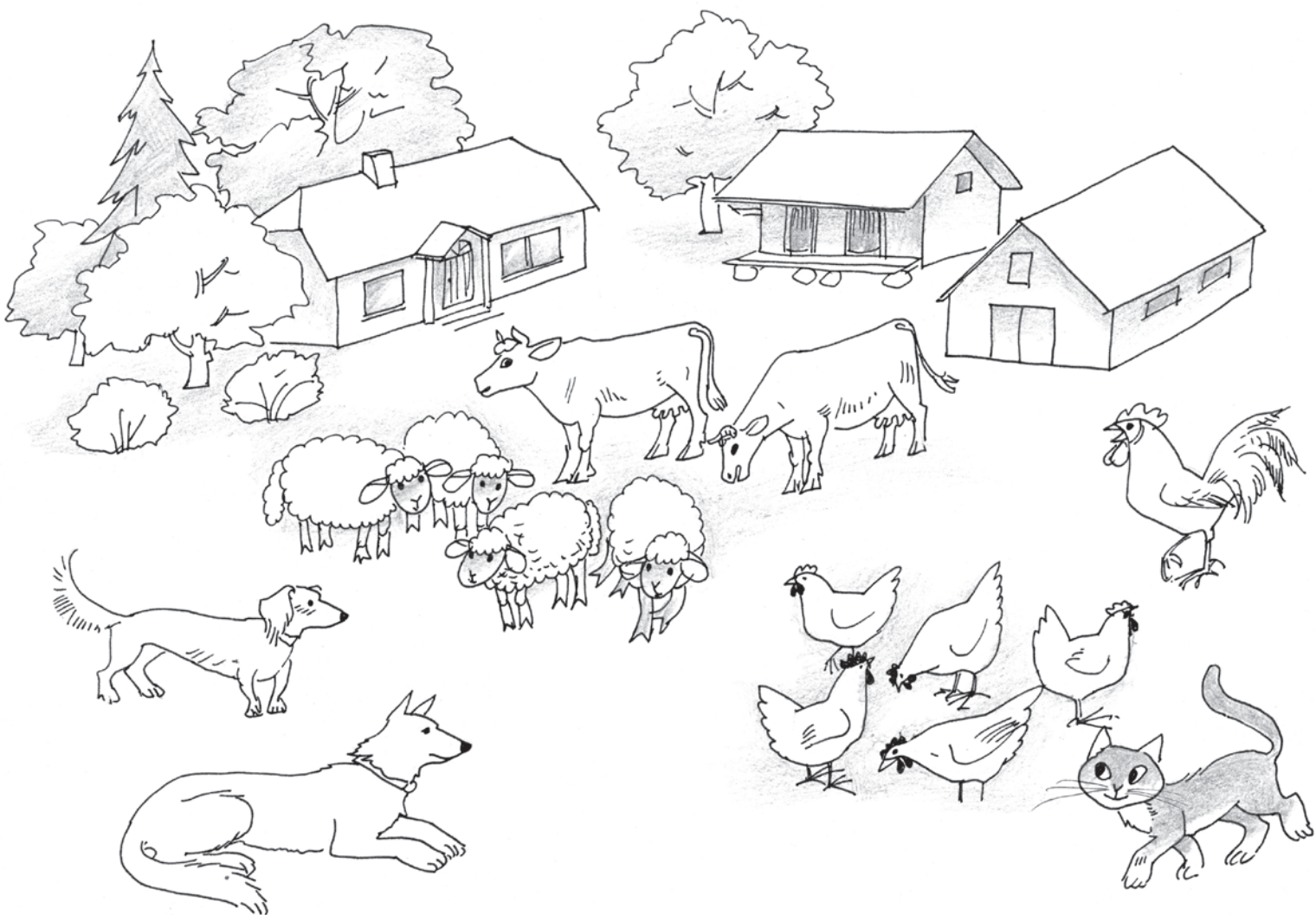

MIS ON PILDIL? MITU?

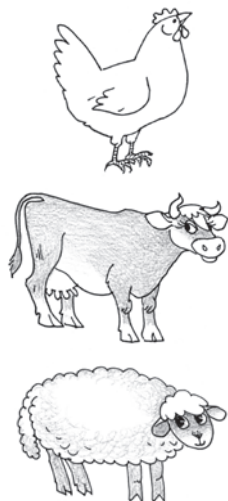

VÄRVI NII+SAMA PALJU RUUTE.

ERALDA IGAST HULGAST VIIS LOOMA. VÄRVI NEED.

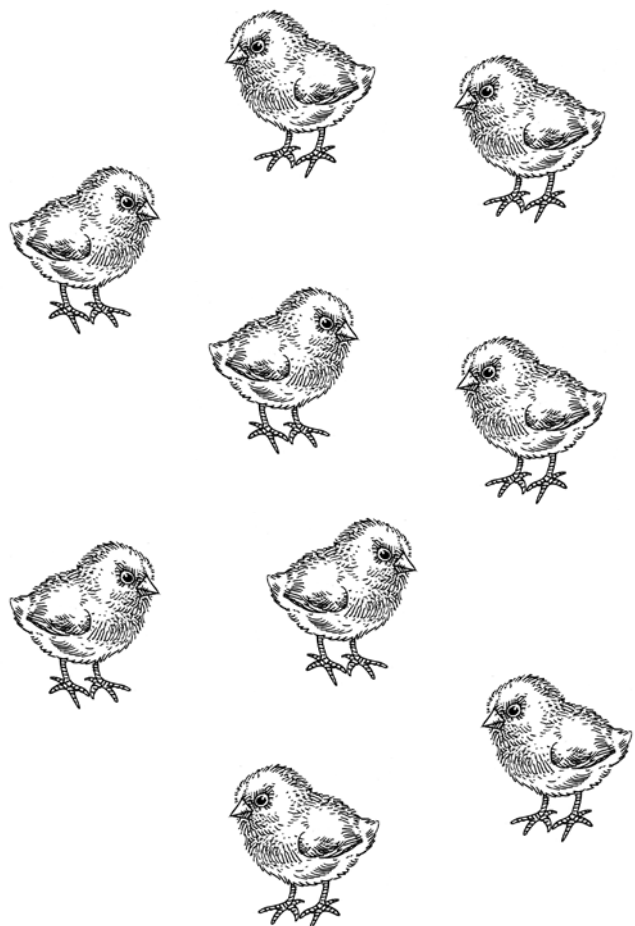
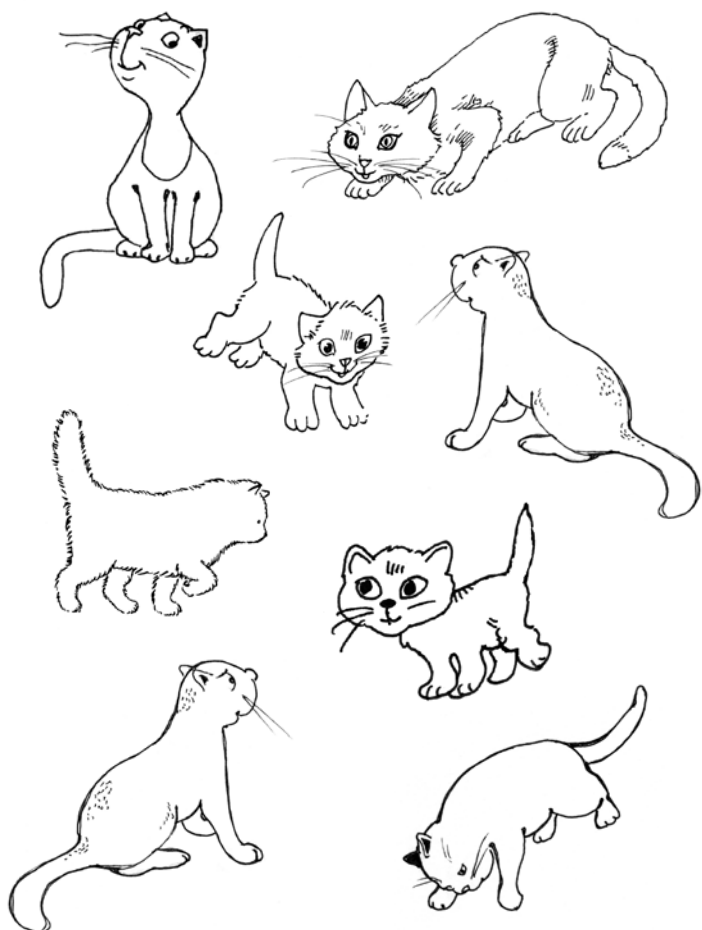
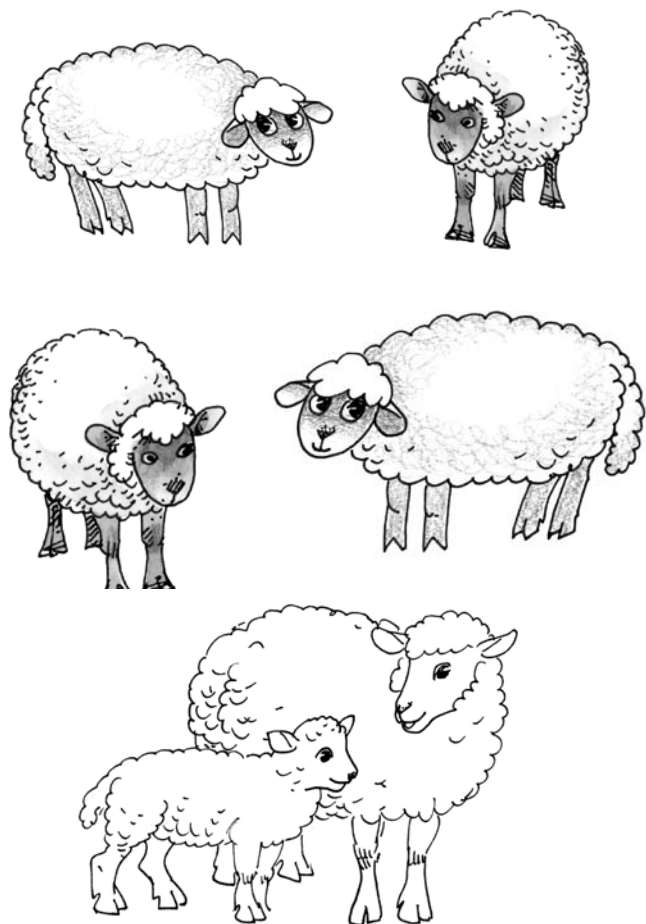
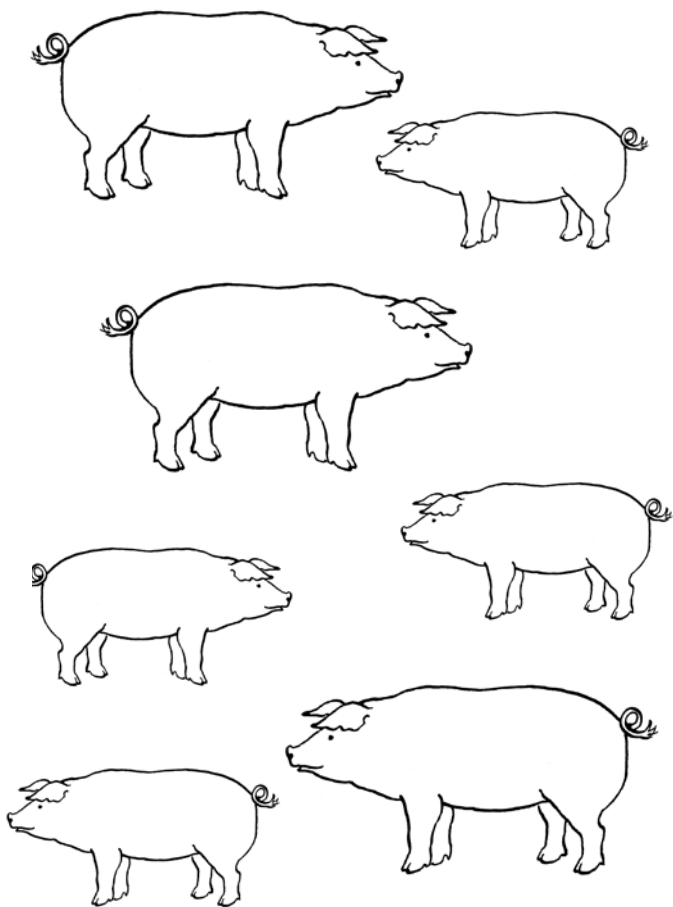

MITU LOOMA ON HULGAS? TÕMBA ÕIGELE ARVULE RING ÜMBER.
VÄRVI HULK, MILLES ON VIIS LOOMA.

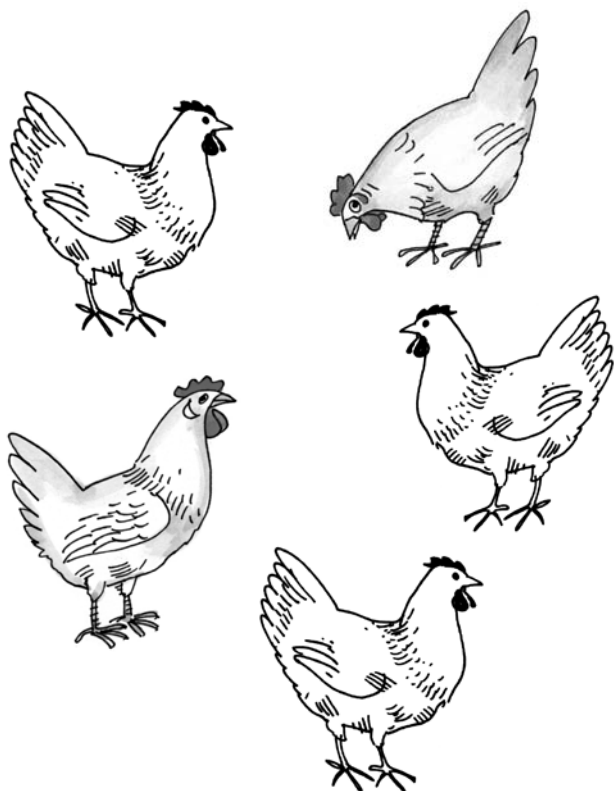

1	2	3	4	5

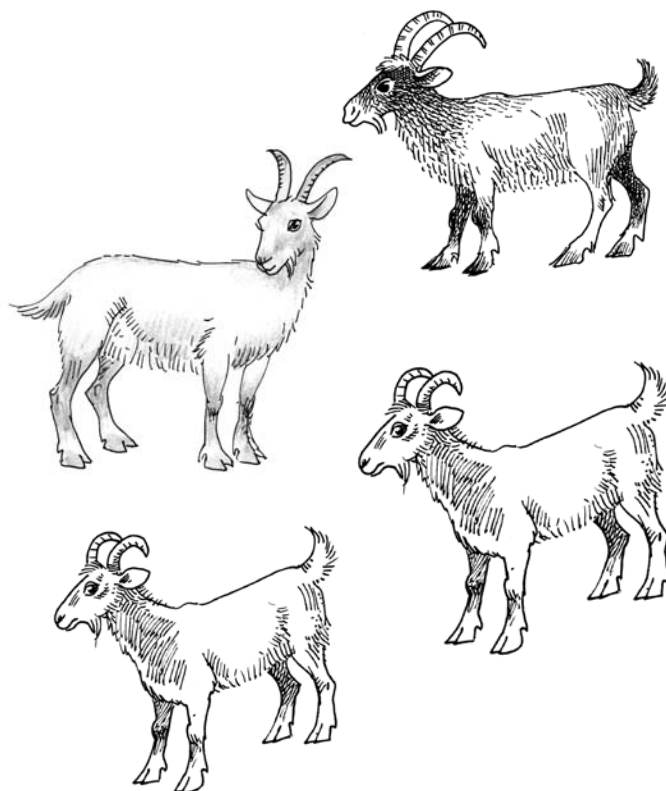

1	2	3	4	5

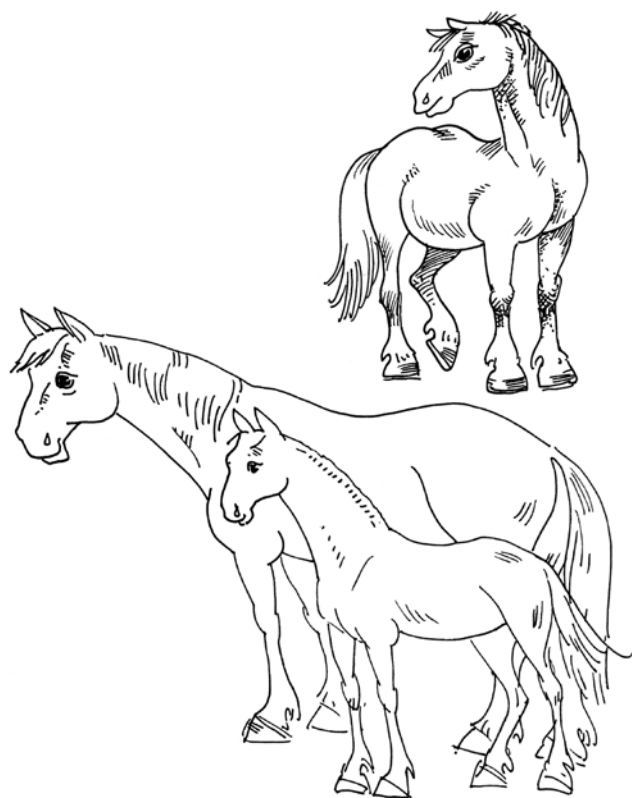

1	2	3	4	5

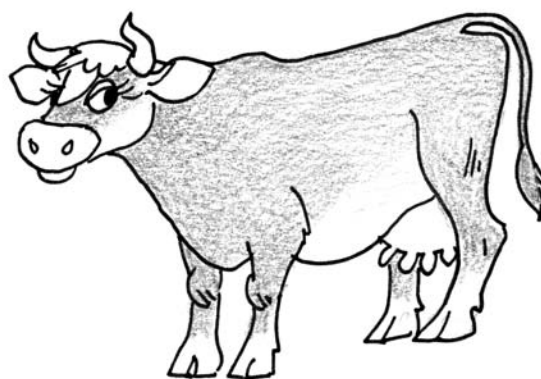

1	2	3	4	5

JÄTKA RIDA.

0	0	0	0	0	0	0	0	0	0	0	0	0	0	0
5	5	5	5	5	5	5	5	5	5	5	5	5	5	5
5	5	5	5	5	5	5	5	5	5	5	5	5	5	5
5	5	5	5	5	5	5	5	5	5	5	5	5	5	5
5	5	5	5	5	5	5	5	5	5	5	5	5	5	5
5	5	5	5	5	5	5	5	5	5	5	5	5	5	5

KIRJUTA PUUDUVAD NUMBRID. LOE ARVU+RIDA. VÄRVI RUUDUD.

A pyramid of 10 squares arranged in four rows: 1 square in the top row, 2 in the second, 3 in the third, and 4 in the bottom. A rooster is on the left, and another is on the right. Arrows point from the roosters towards the center of the pyramid.

1			4				2	
---	--	--	---	--	--	--	---	--

KIRJUTA PILDID JUURDE ÕIGE ARV. VÄRVI HULK, MILLES ON VIIS LINDU.

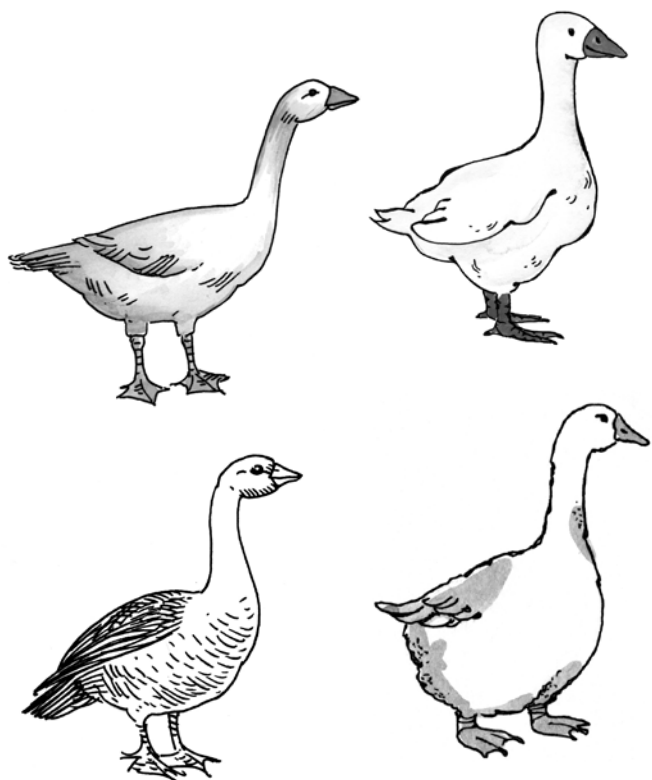

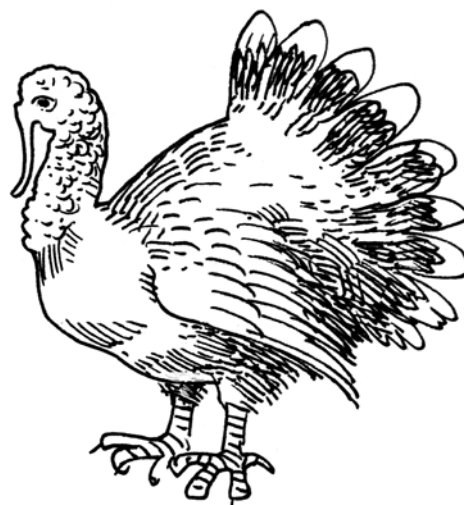

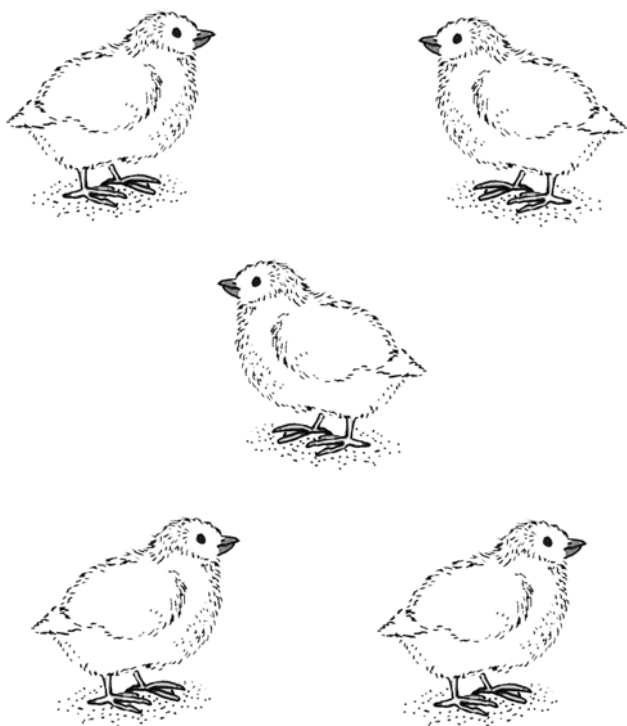

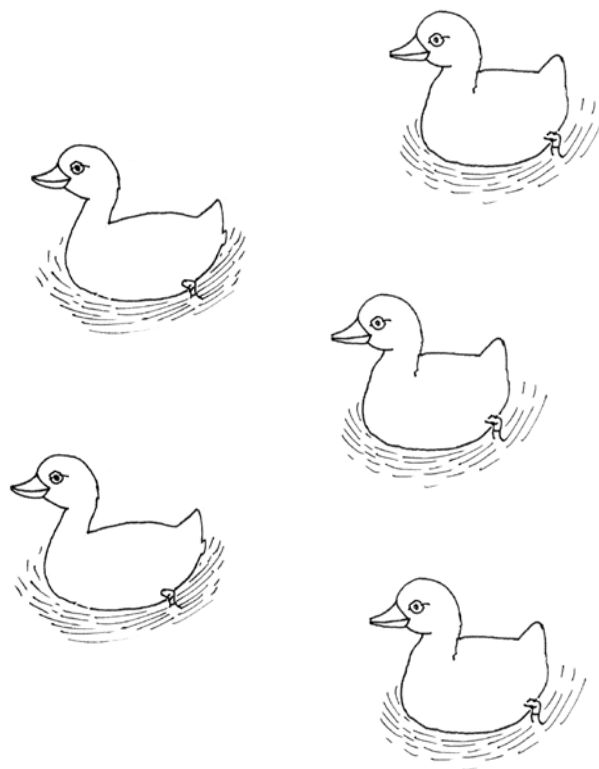

LEIA VALESTI KIRJUTATUD NUMBER. PÕHJENDA.

ÕIGESTI KIRJUTATUD NUMBER KIRJUTA ÜLE.

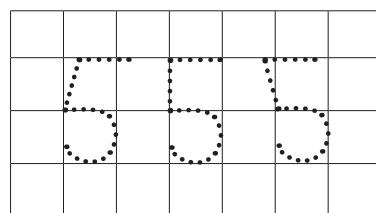
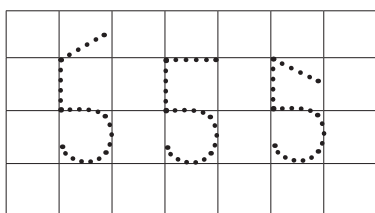
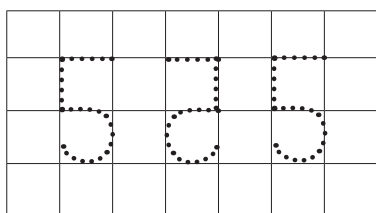

KIRJUTA ÕIGESTI.

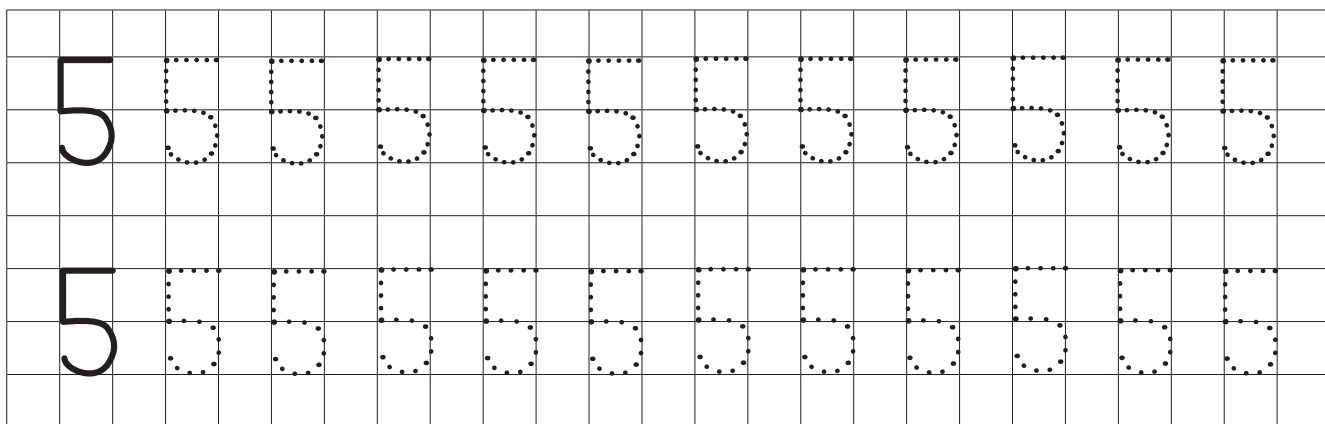

PIIRA LOOMADE HULGAD JOONEGA.

ÜHENDA JOONEGA ARV, SÕNA JA HULK.

ÜKS KAKS KOLM NELI VIIS

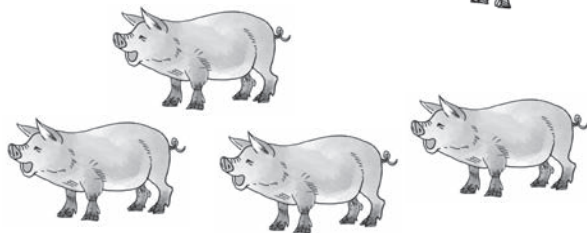
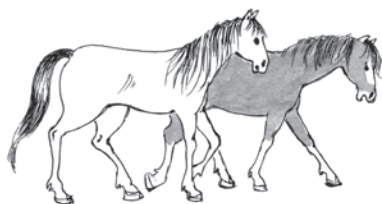
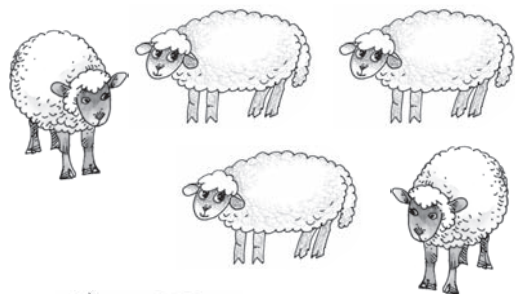
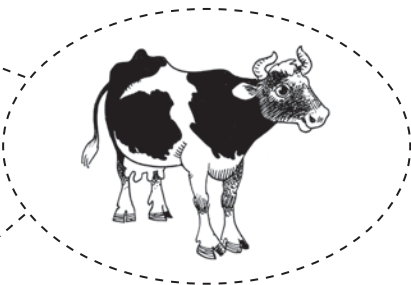
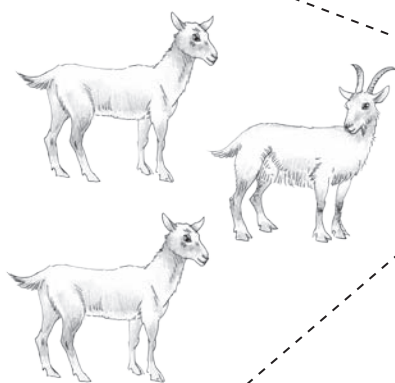

4

2

3

4

5

KIRJUTA PUUDUVAD ARVUD. RÄÄGI.

5

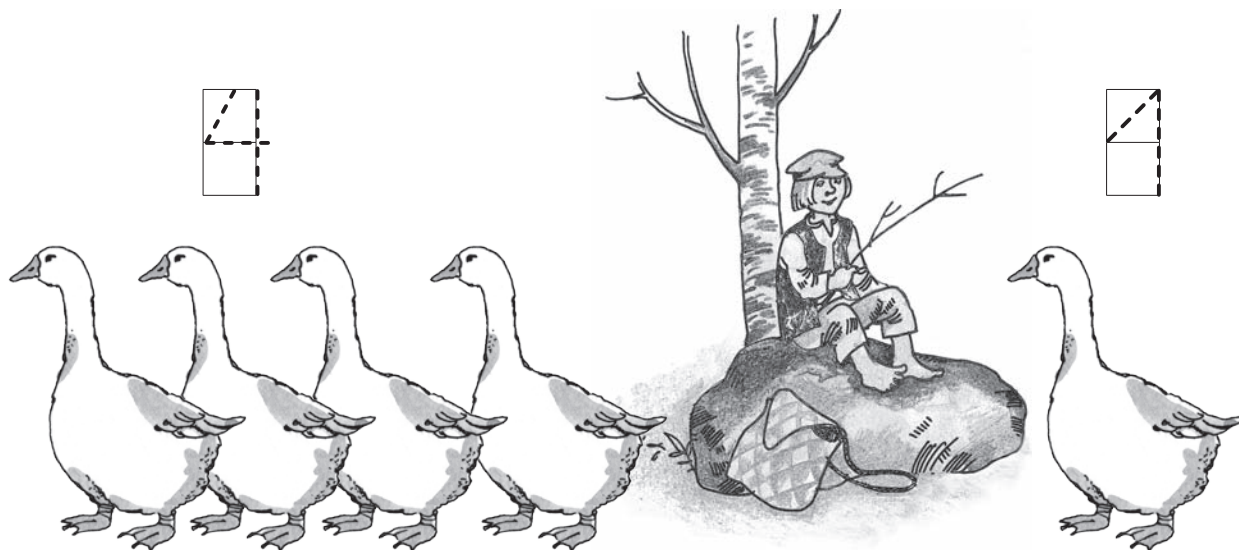

ON JA

5

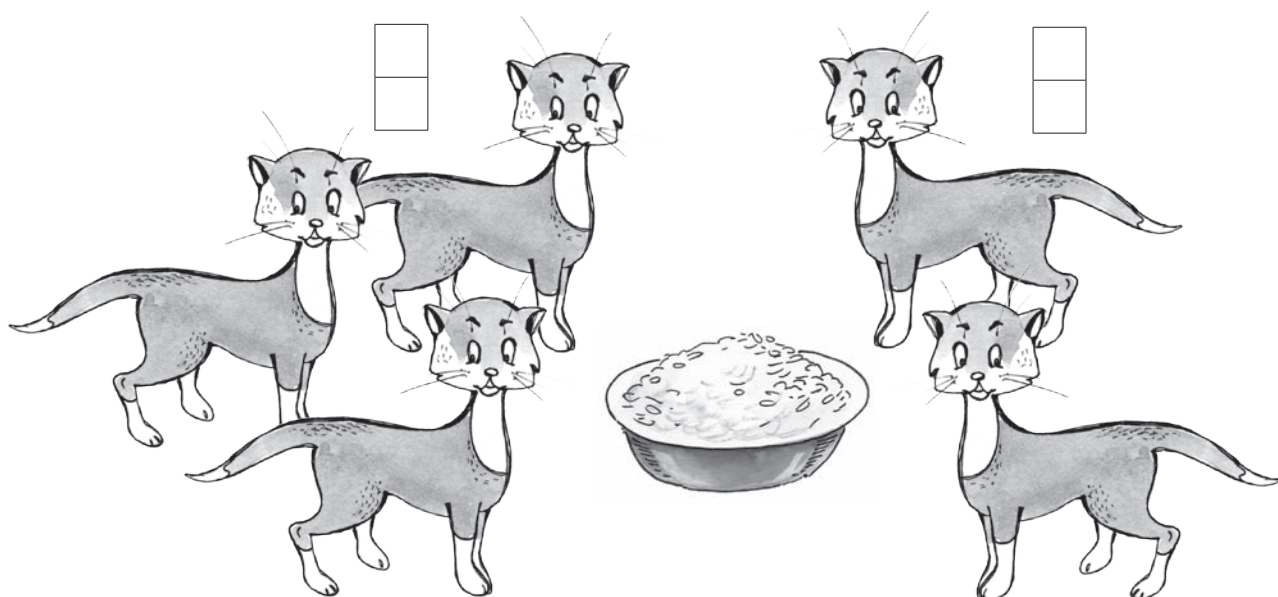

ON JA

KIRJUTA PUUDUVAD ARVUD. RÄÄGI.

5

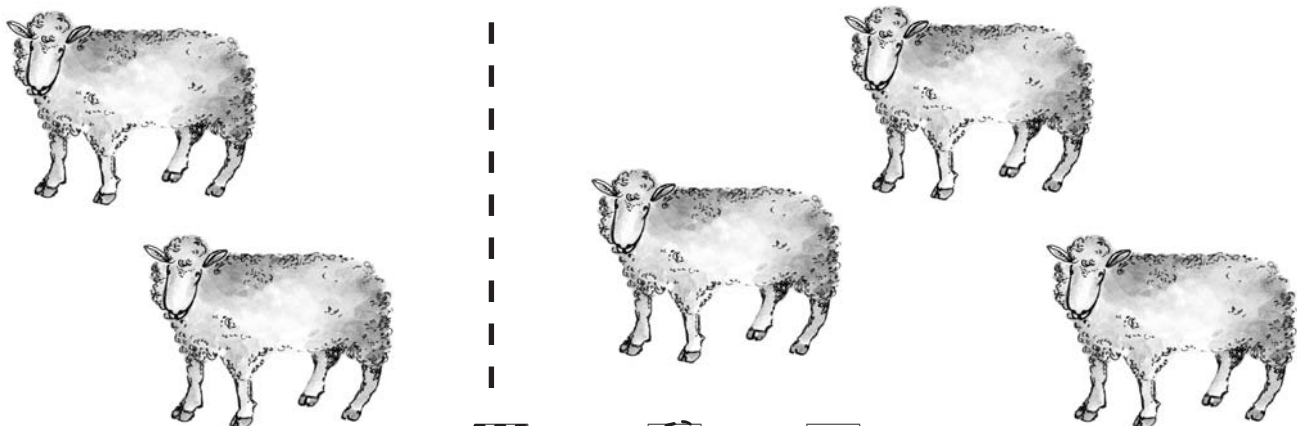

ON JA

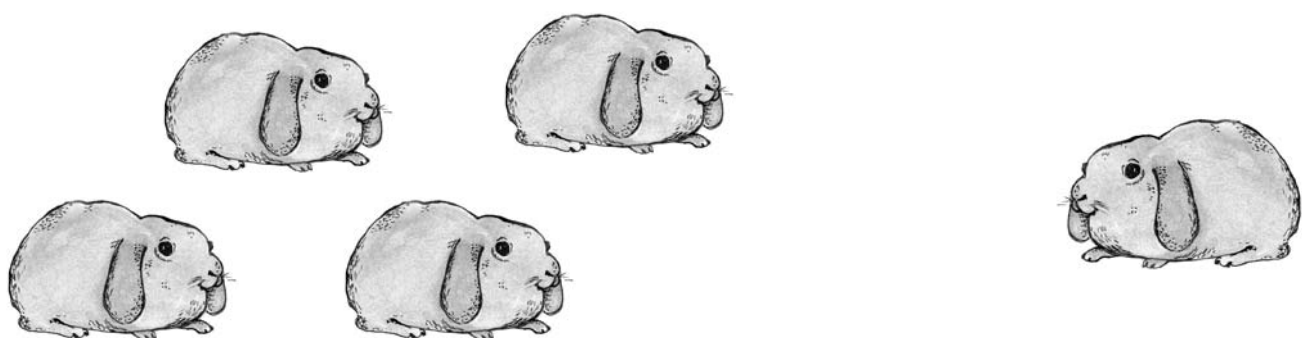

ON JA

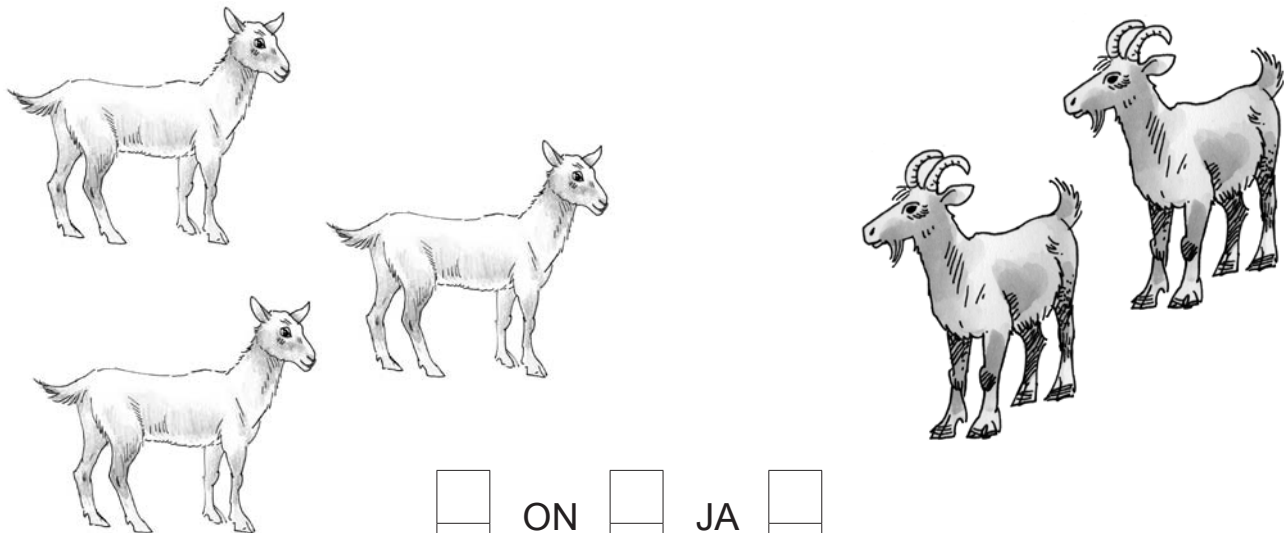

ON JA

JOONISTA VAJALIK ARV RINGE. RÄÄGI.

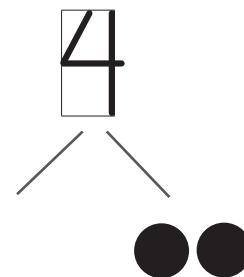
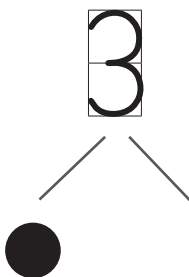
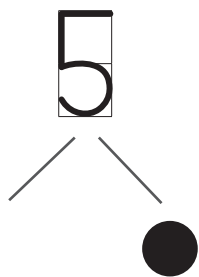
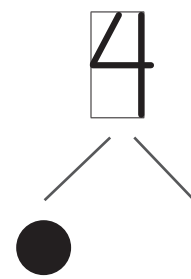
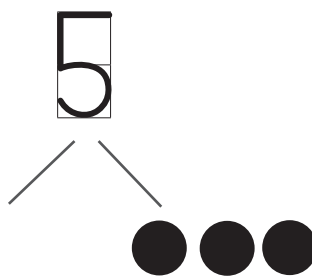
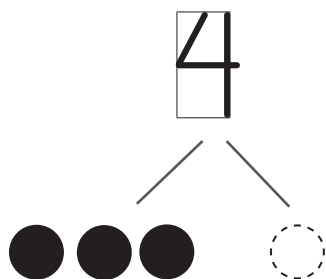

KIRJUTA PUUDUVAD NUMBRID. RÄÄGI.

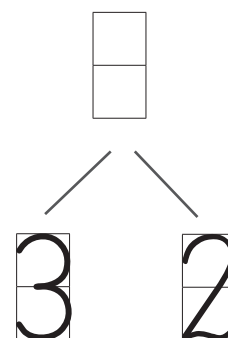
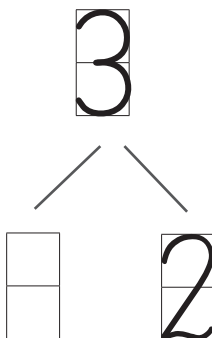
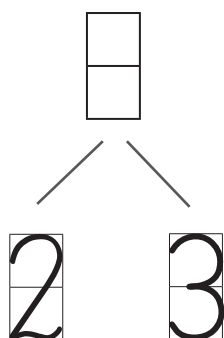
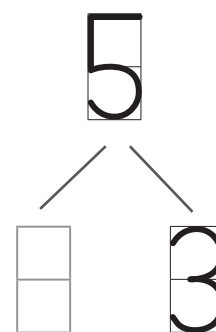
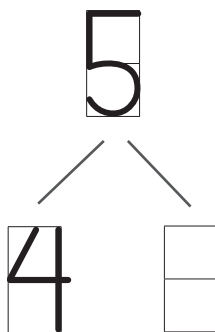
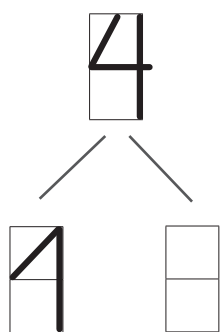

KIRJUTA PUUDUVAD ARVUD.

5

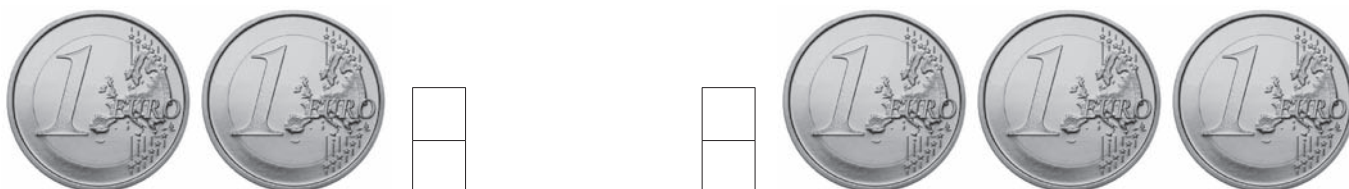
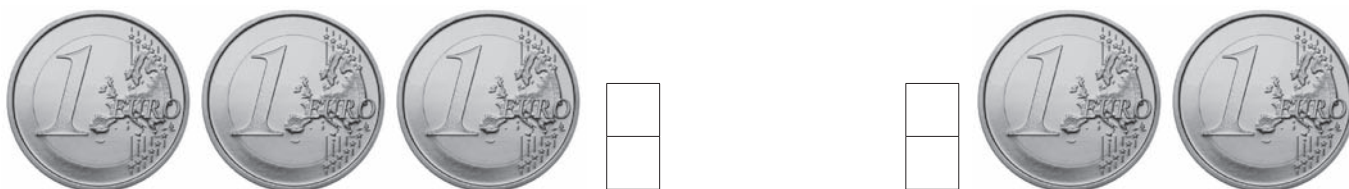

RÄÄGI.

ON JA

KIRJUTA PUUDUVAD ARVUD.

RÄÄGI.

ON JA



5	
4	JA <input type="text"/>
2	JA <input type="text"/>
3	JA <input type="text"/>
4	JA <input type="text"/>

VÖRDLE HULKI JA ARVE. KIRJUTA PUUDUVAD ARVUD JA MÄRGID.

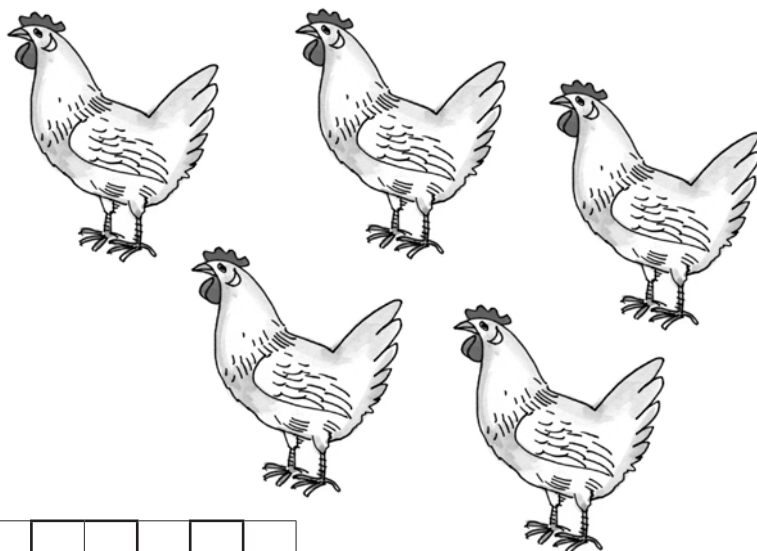
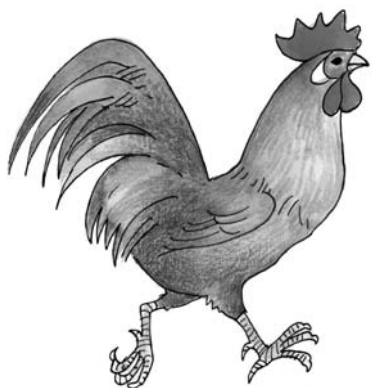

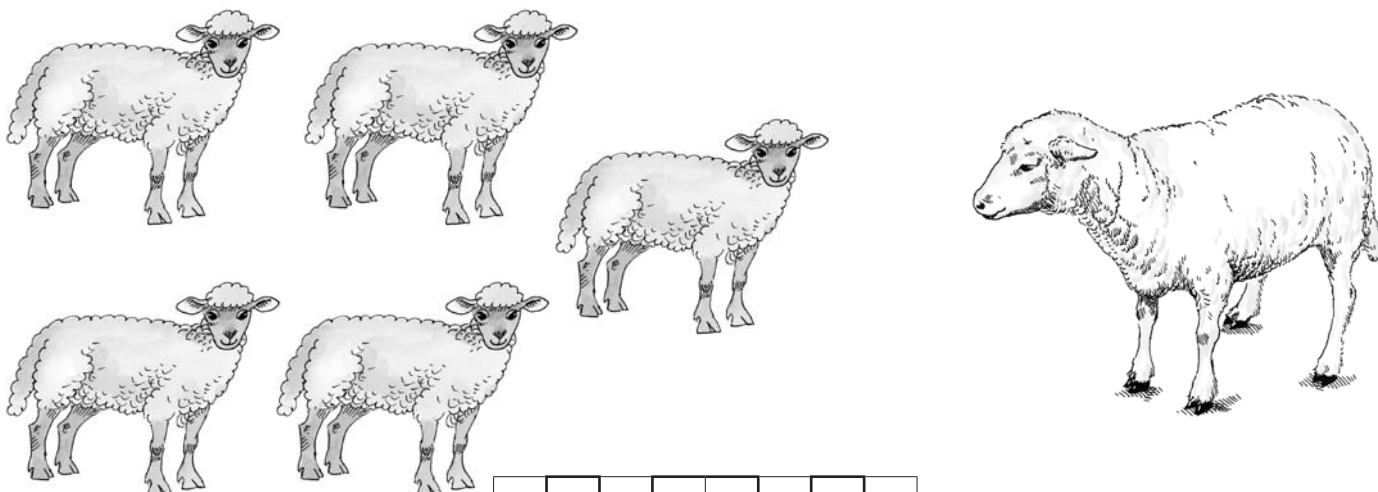

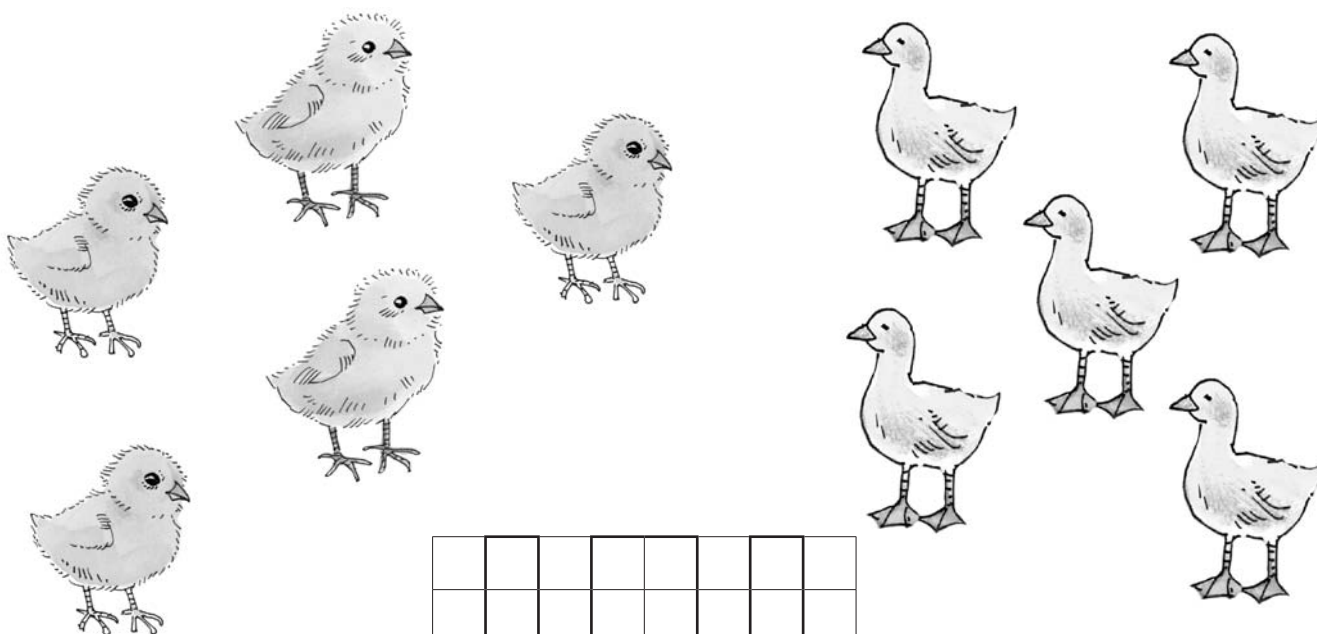

VÄRVI VAJALIK ARV RUUTE. VÖRDLE.

1			5	

5			2	

5			5	

4			5	

5			3	

4			4	

MITU? MITMES?



MITU LOOMA ON?

KASS ON

LAMMAS ON

KUKK ON

KOER ON

KITS ON

ESIMENE

TEINE

KOLMAS

NELJAS

VIIES

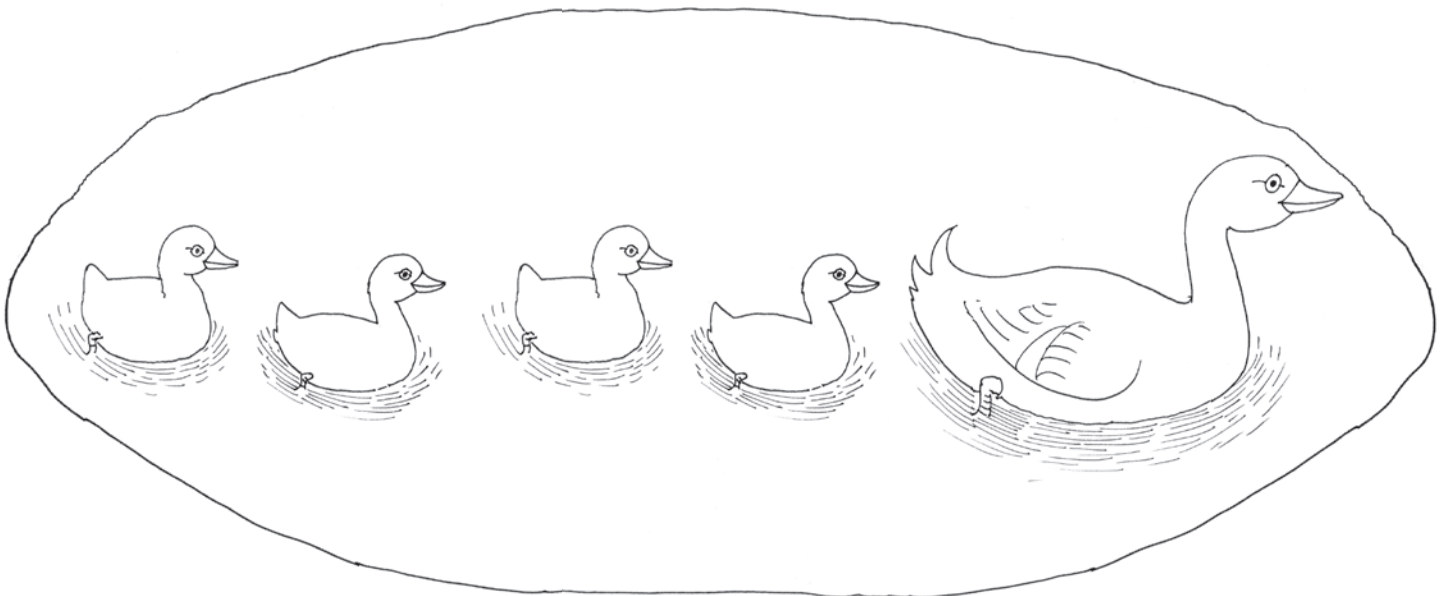

MITU PARTI ON?

MITU PARDI+POEGA ON?

MITMES ON PARDI+EMA?

KIRJUTA PILDID JÄRGI LIITMIS+ÜLESANNE. ARVUTA. LOE.

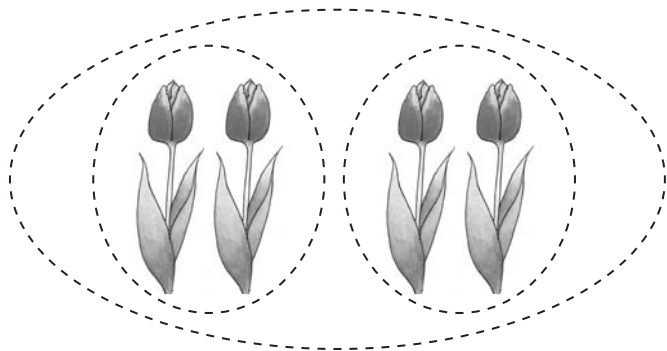

		+		=		

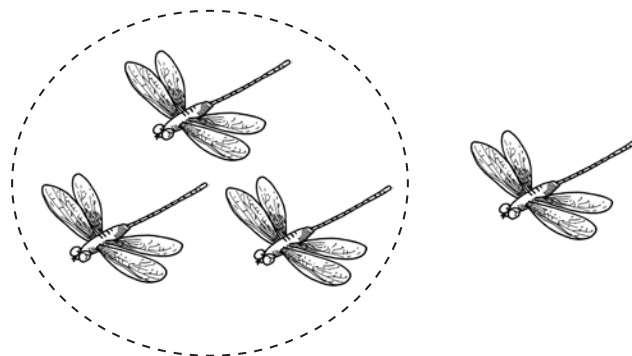

		+		=		

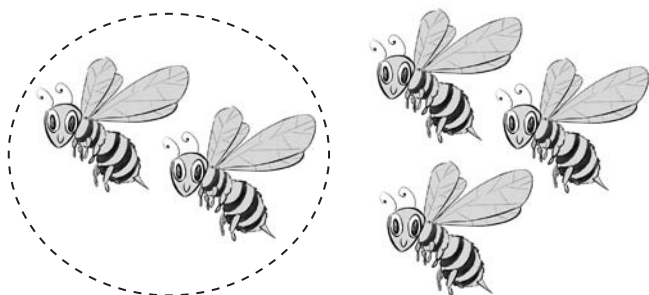

		+		=		

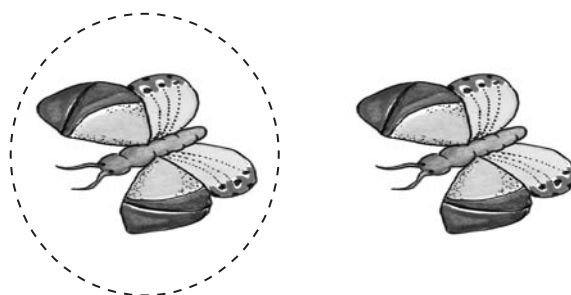

		+		=		

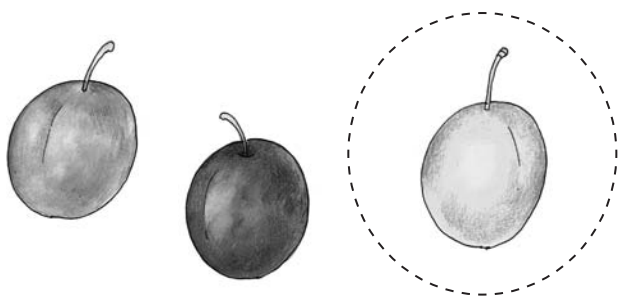

		+		=		

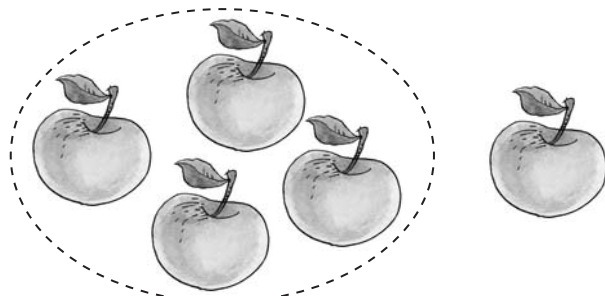

		+		=		

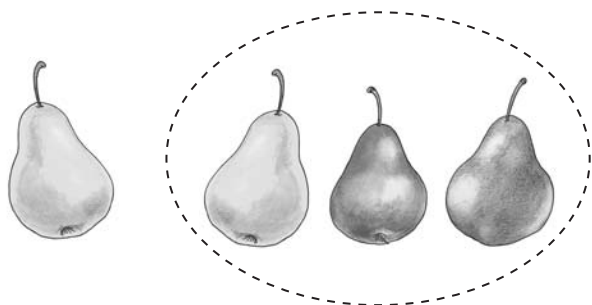

		+		=		

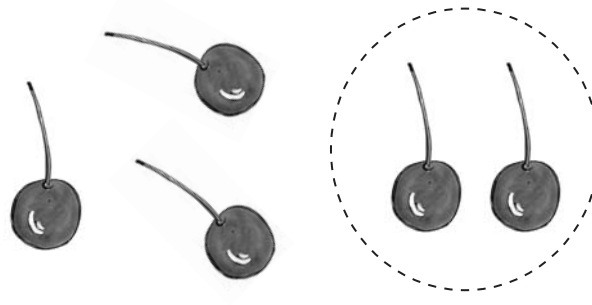

		+		=		

JOONISTA LIITMIS+ÜLESANDE JÄRGI VAJALIK ARV KUJUNDEID.

ÜHENDA HULGAD JOONEGA. ARVUTA. LOE.

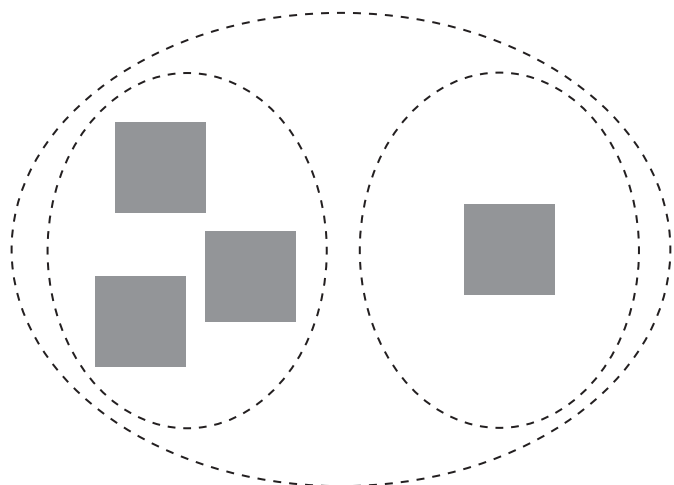

$$3 + 1 = \square$$

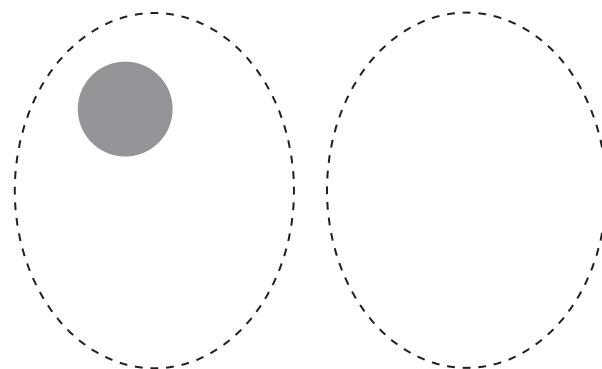

$$4 + 1 = \square$$

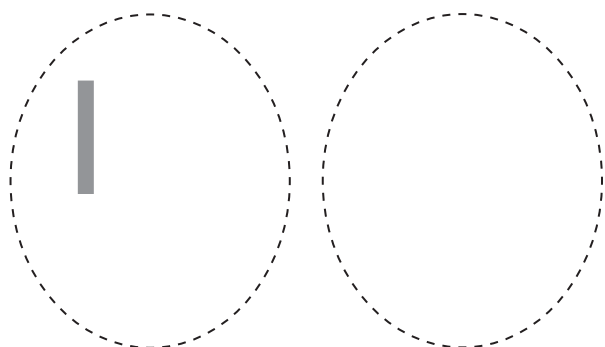

$$2 + 2 = \square$$

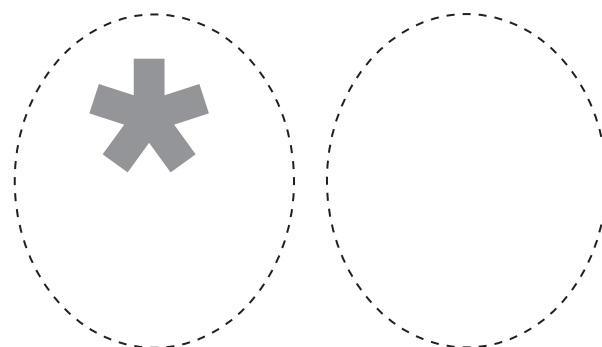

$$2 + 3 = \square$$

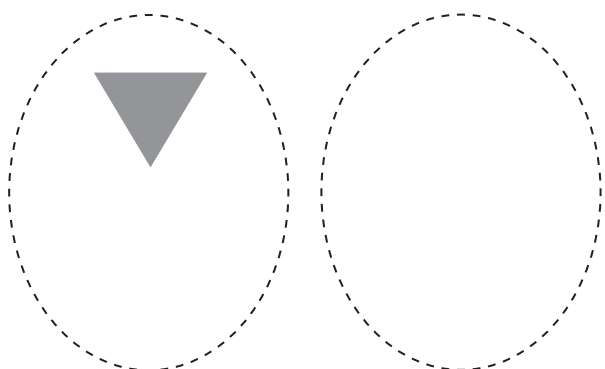

$$1 + 4 = \square$$

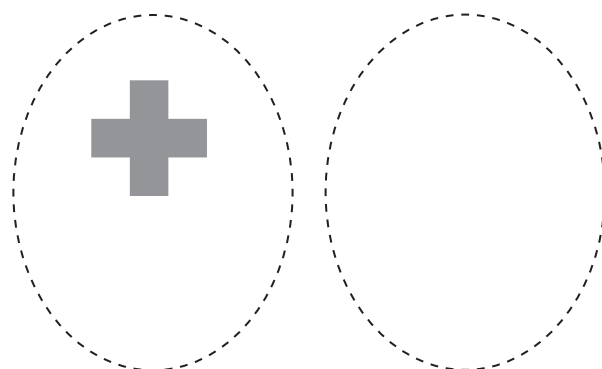

$$1 + 2 = \square$$

JOONISTA VAJALIK ARV KRIIPSE. ÜHENDA HULGAD JOONEGA. ARVUTA. LOE ÜLESANDED.

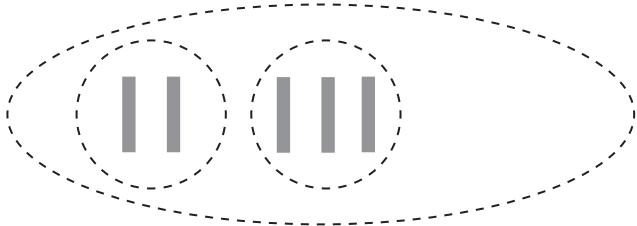

2	+	3	=		
---	---	---	---	--	--

2	+	2	=		
---	---	---	---	--	--

4	+	4	=		
---	---	---	---	--	--

3	+	2	=		
---	---	---	---	--	--

KOOSTA PILDI JÄRGI LIITMIS+ÜLESANNE.



			=	
--	--	--	---	--

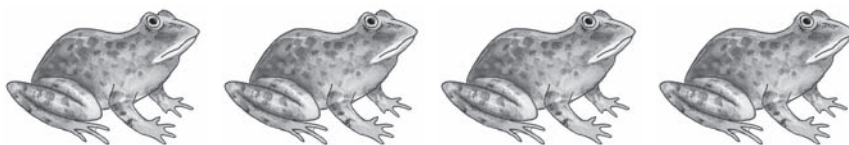

			=	
--	--	--	---	--



			=	
--	--	--	---	--



ÜHENDA JOONEGA SARNASED PILDID.

VÄRVI LILLED SARNASTEL PILTIDEL SAMA VÄRVIGA.

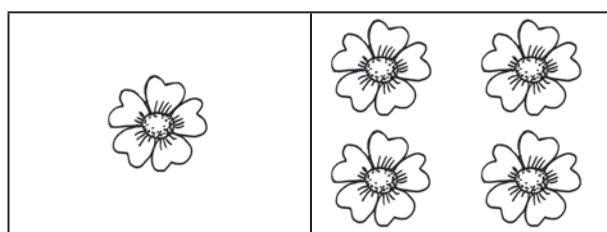
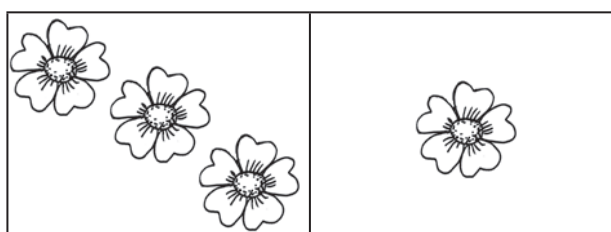
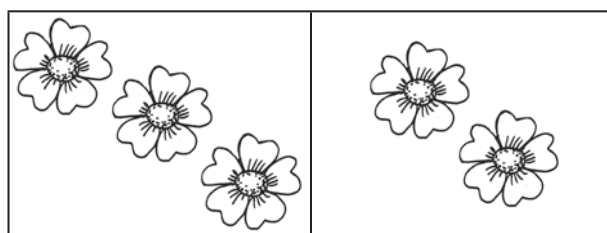
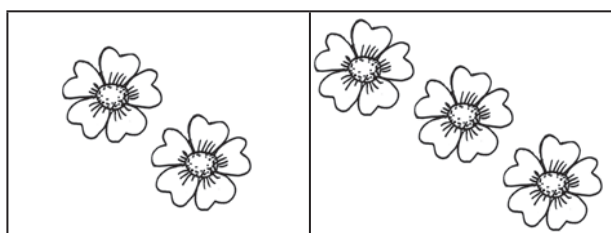
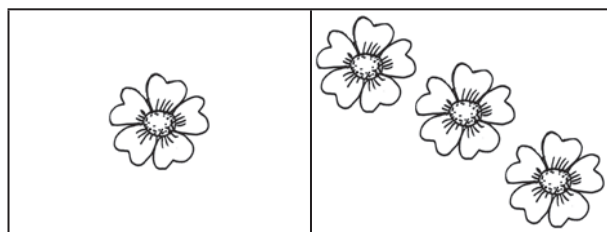
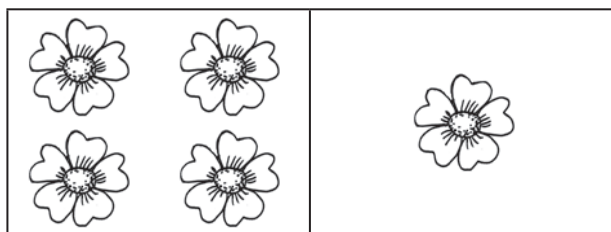

ARVUTA. ÜHENDA SARNASED ÜLESANDED JOONEGA. **LOE.**

$$\begin{array}{|c|c|c|c|c|c|c|} \hline 4 & + & 1 & = & & & \\ \hline \end{array}$$

$$\begin{array}{|c|c|c|c|c|c|c|} \hline 3 & + & 2 & = & & & \\ \hline \end{array}$$

$$\begin{array}{|c|c|c|c|c|c|c|} \hline 2 & + & 3 & = & & & \\ \hline \end{array}$$

$$\begin{array}{|c|c|c|c|c|c|c|} \hline 1 & + & 2 & = & & & \\ \hline \end{array}$$

$$\begin{array}{|c|c|c|c|c|c|c|} \hline 3 & + & 1 & = & & & \\ \hline \end{array}$$

$$\begin{array}{|c|c|c|c|c|c|c|} \hline 1 & + & 4 & = & & & \\ \hline \end{array}$$

$$\begin{array}{|c|c|c|c|c|c|c|} \hline 2 & + & 1 & = & & & \\ \hline \end{array}$$

$$\begin{array}{|c|c|c|c|c|c|c|} \hline 1 & + & 3 & = & & & \\ \hline \end{array}$$

KIRJUTA IGA PILDİ JÄRGI KAKS LIITMIS+ÜLESANNET.

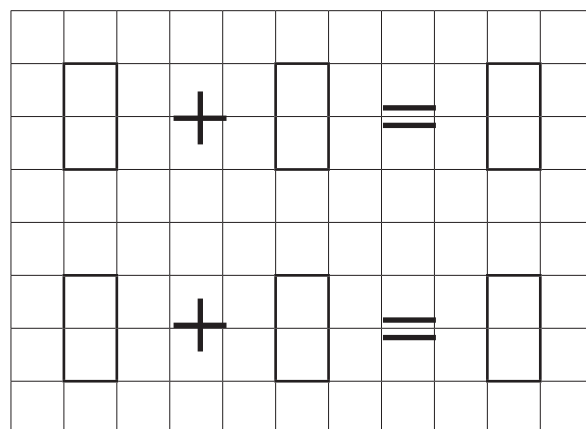
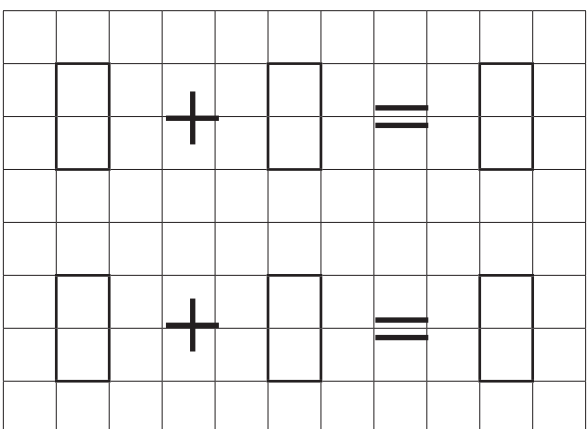
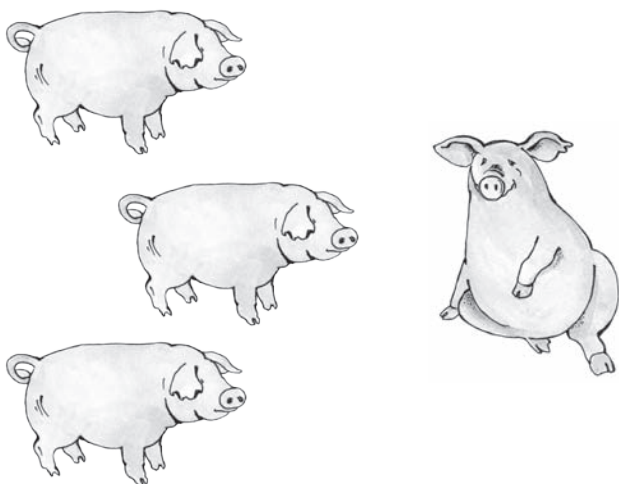
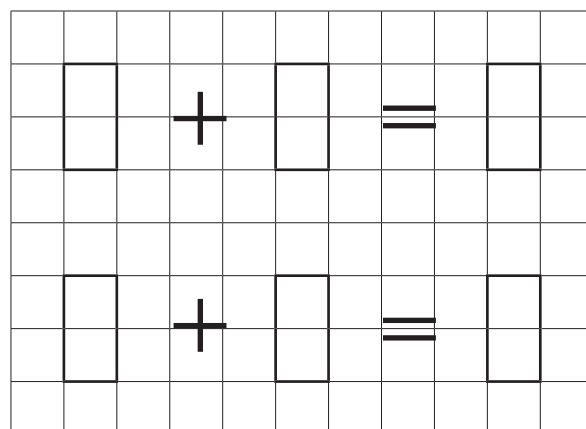
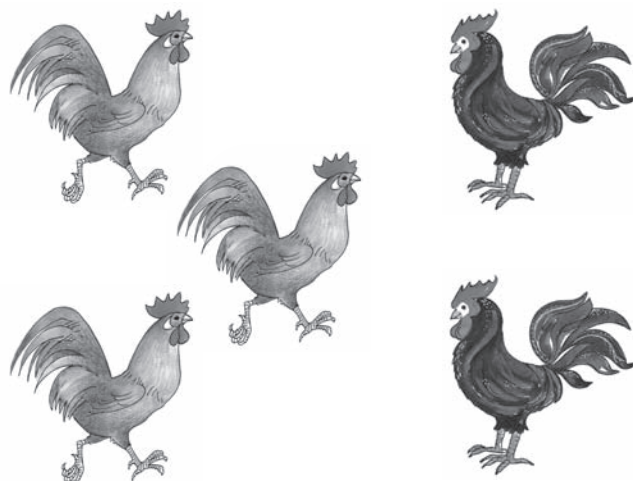
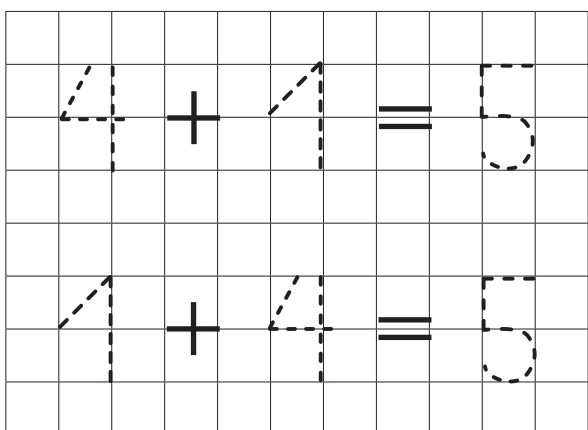
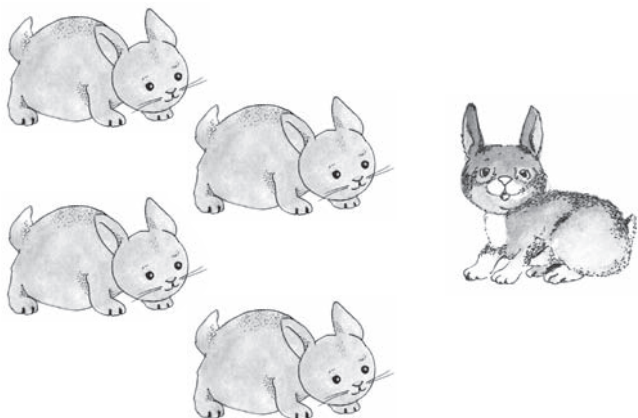

KIRJUTA ÜLESANNE VIHIKUSSE. ARVUTA.

$4 + 1$

$3 + 2$

$3 + 1$

$2 + 2$

$2 + 1$

$1 + 2$

$1 + 1$

$2 + 3$

AITA IGAL TIBUL LEIDA TEMA PESA. ÜHENDA JOONEGA.

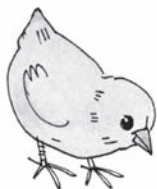

$2 + 1$

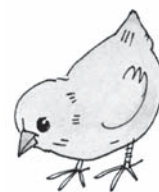
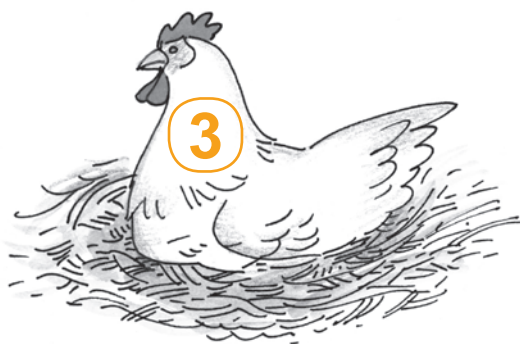

$4 + 1$

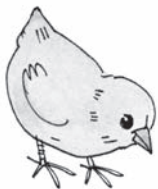

$3 + 2$



$1 + 2$



$3 + 1$

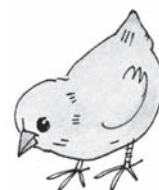

$1 + 3$

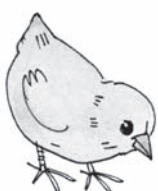

$1 + 4$

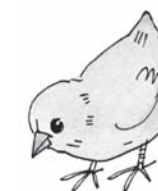
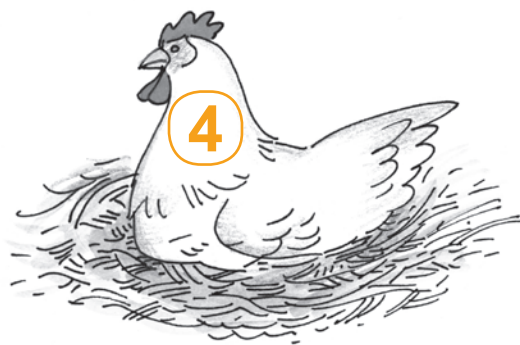

$2 + 3$

OLI _____ . _____ TOOB JUURDE _____ . MITU _____ ?

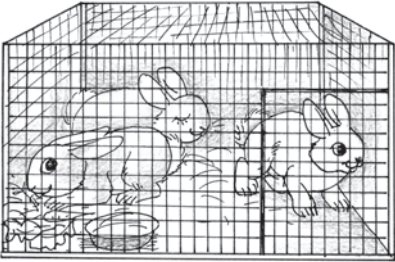
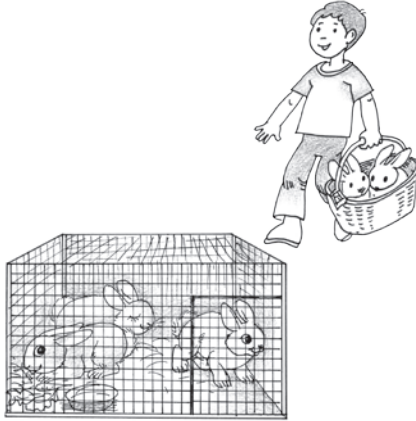
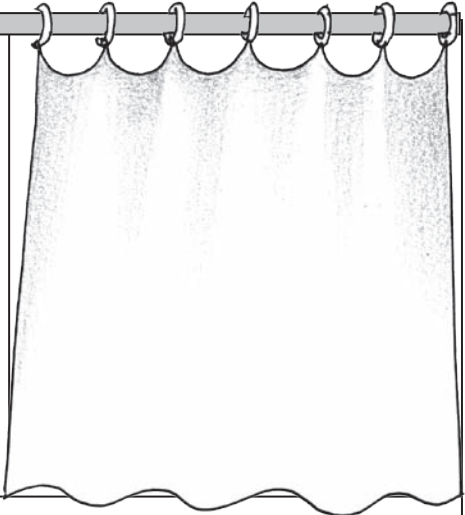
		
<input type="text"/> KÜÜLIKUT	<input type="text"/> <input type="text"/> KÜÜLIK	= <input type="text"/> KÜÜLIKUT

OLI _____ . _____ LENDAB JUURDE. MITU _____ .

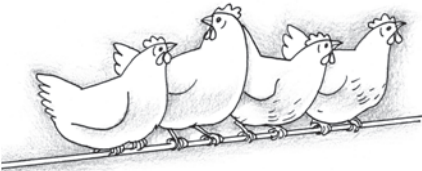
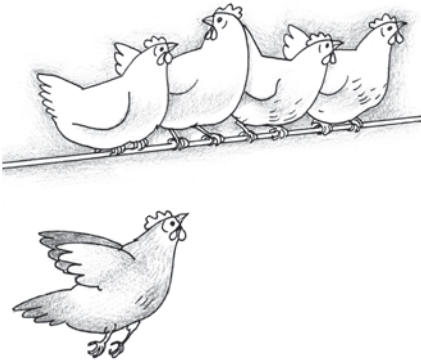
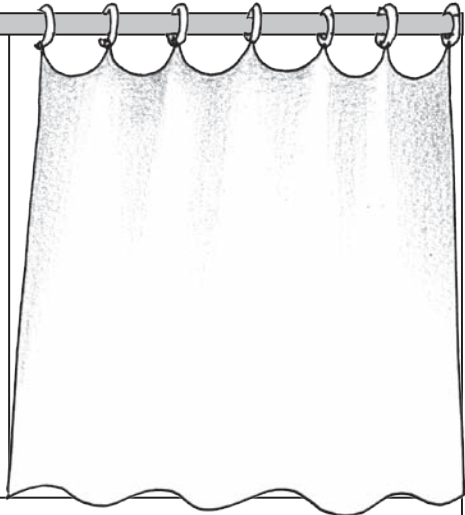
		
<input type="text"/> KANA	<input type="text"/> <input type="text"/> KANA	= <input type="text"/> KANA

KOOSTA PILTIDE JÄRGI TEKST+ÜLESANNE.

VALI SOBIV TEHTE+MÄRK. **KIRJUTA** ÜLESANDE LAHENDUS. **LOE.**

PIIRA JOONEGA SAMA VÄRVI LOOMAD. **ÜHENDA** JOONEGA KASSIDE HULK. **LOE.**

The image shows three cats, each enclosed in a dashed oval. From left to right: a white cat, a black and white cat, and a striped cat. Arrows point from each oval towards a math grid below. The grid contains the equation: $1 + 1 + 1 = 3$.

PIIRA JOONEGA SARNASED LOOMAD. **ÜHENDA** JOONEGA KODU+LOOMADE HULK. **KIRJUTA** PUUDUVAD NUMBRID. **LOE.**

The image shows two cows grouped together in a dashed oval. To their right is a pig, and to the right of the pig is a dog. Arrows point from the pig to the cows and from the dog to the pig. Below the animals is a math grid with the equation: $2 + 1 + 1 = \square$.

PIIRA JOONEGA SARNASED LINNUD. **ÜHENDA** JOONEGA KODU+LINDUDE HULK. **KIRJUTA** PUUDUVAD NUMBRID. **LOE.**

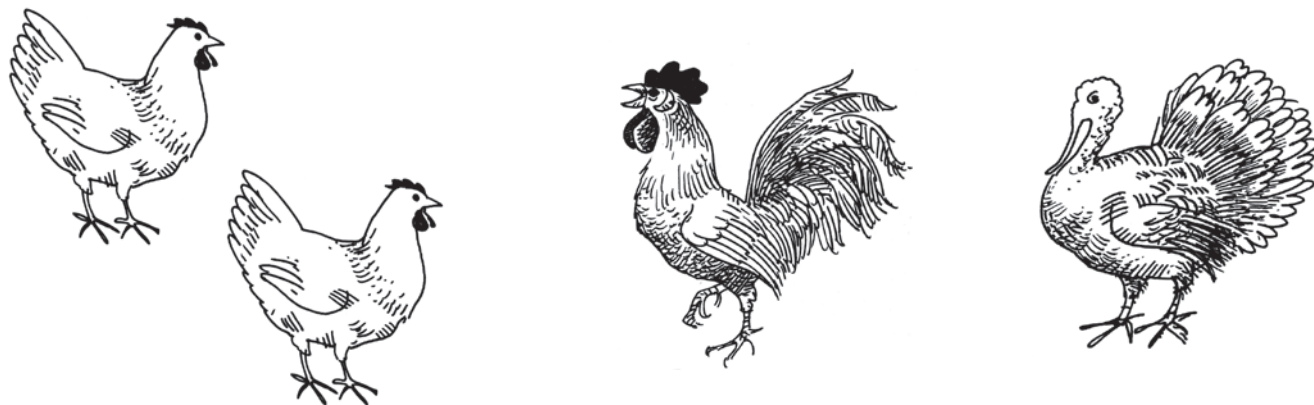

2	+	1	+	1	=	
---	---	---	---	---	---	--

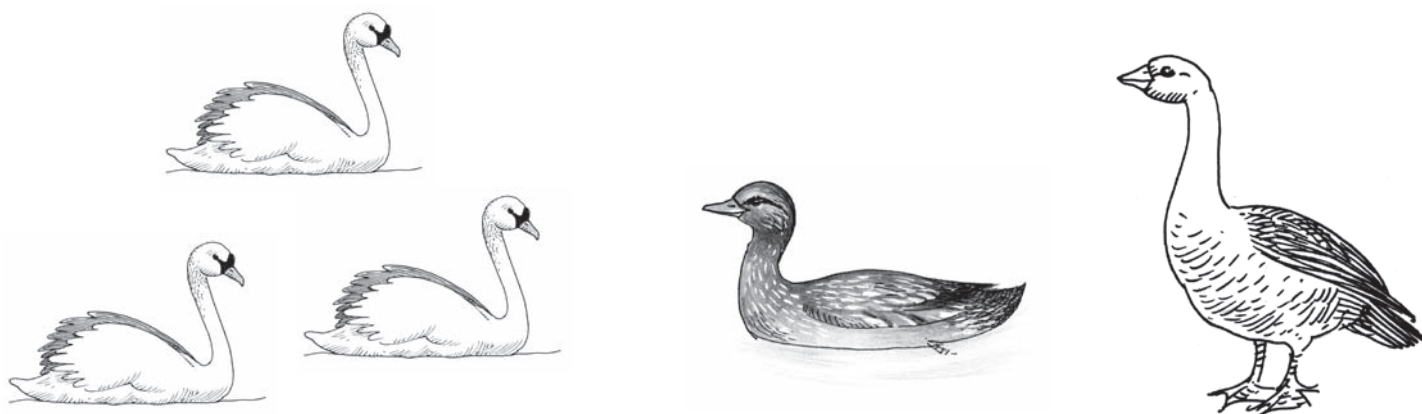

	+		+		=	
--	---	--	---	--	---	--

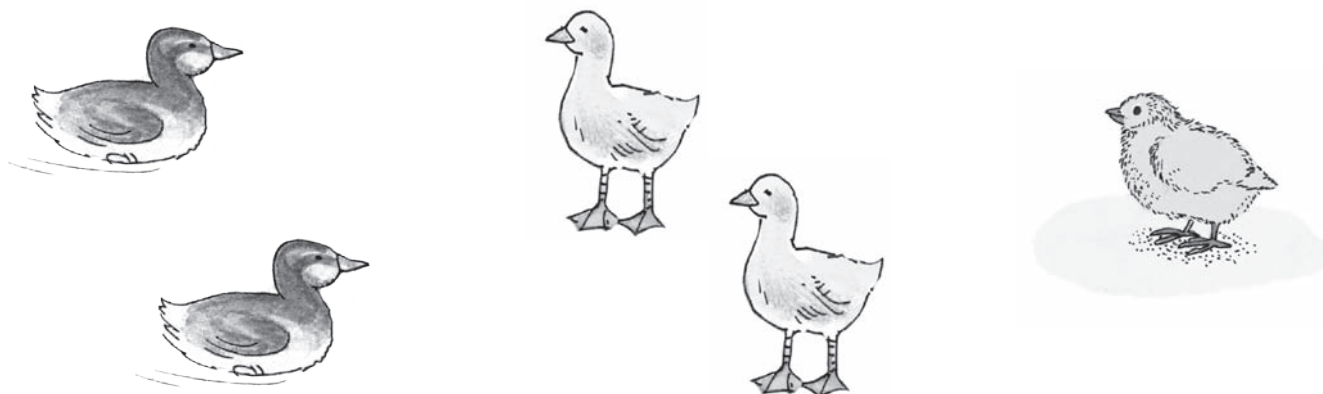

	+		+		=	
--	---	--	---	--	---	--

PIIRA LAMMASTE HULK JOONEGA. **ERALDA** JOONEGA VÄIKESED LAMBAD.

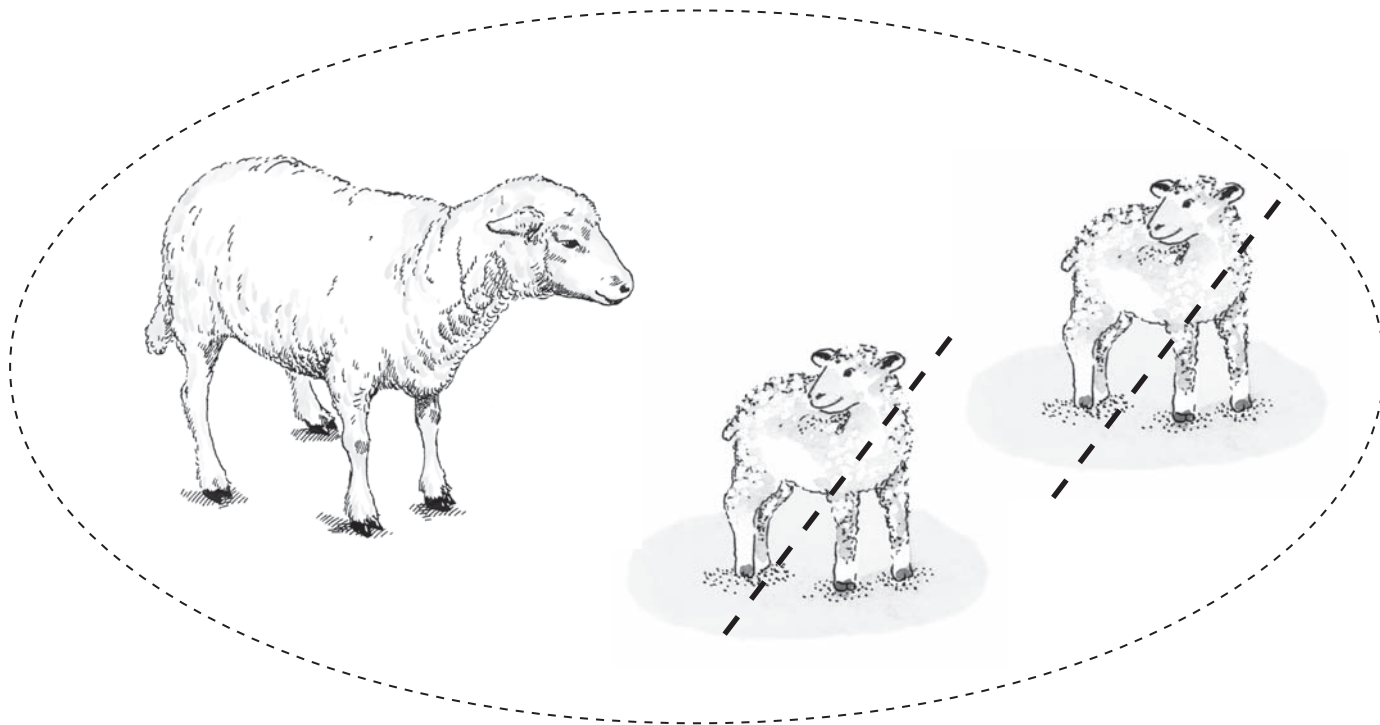

PIIRA JÄNESTE HULK JOONEGA. **ERALDA** JOONEGA HALL JÄNES. **VÄRVI** ÜLE+JÄÄNUD JÄNESED.

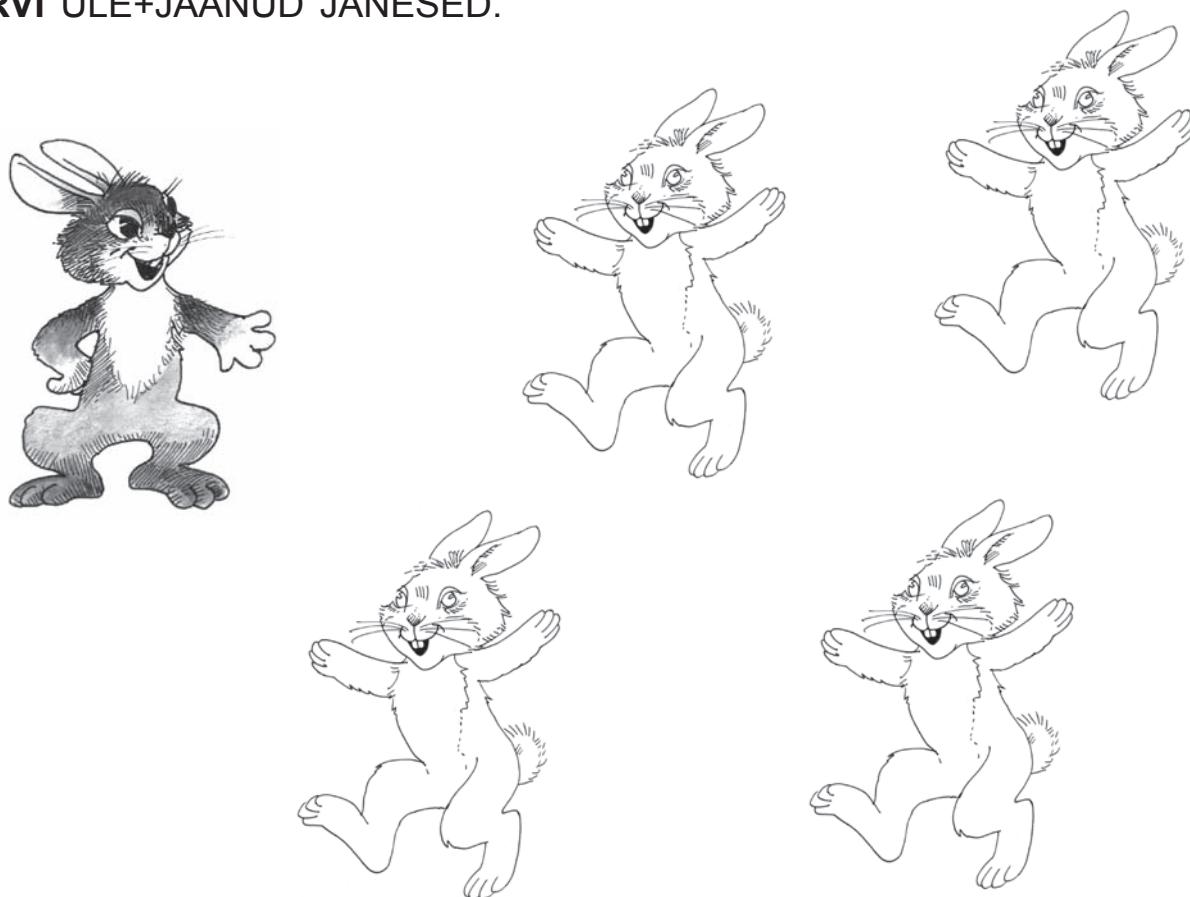

PIIRA HOBUSTE HULK JOONEGA. **ERALDA** JOONEGA HOBUNE, KES LÄHEB ÄRA.

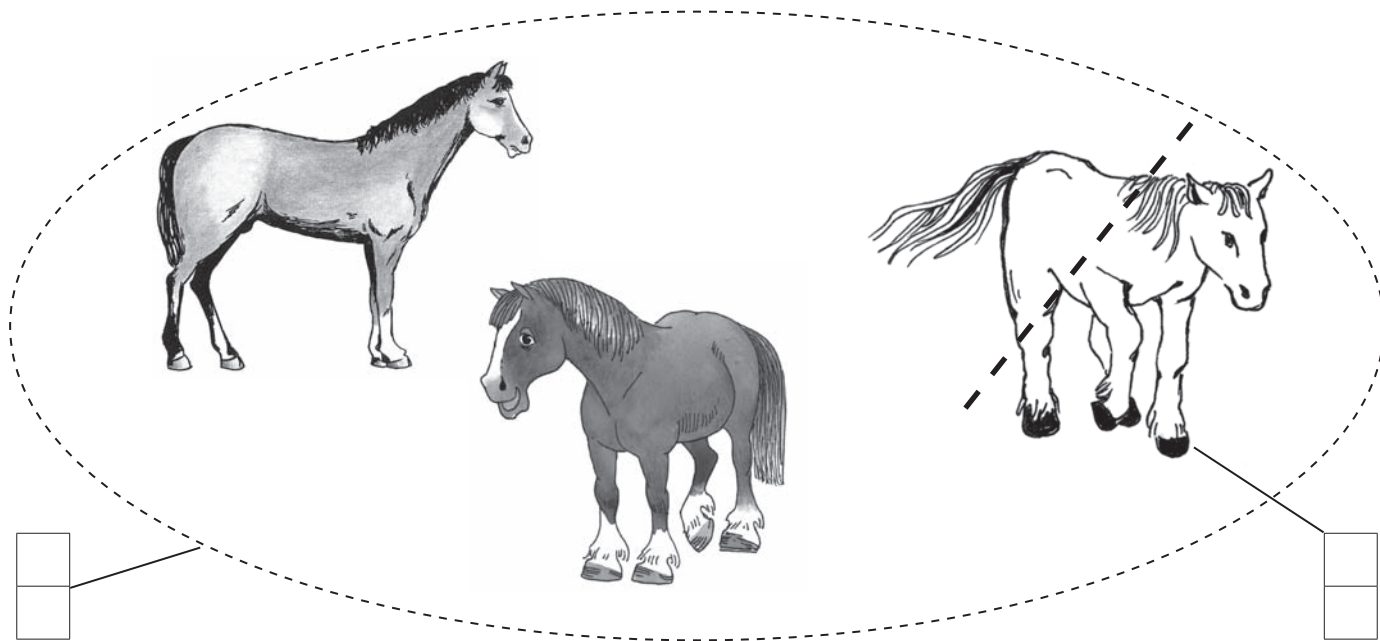

RÄÄGI. OLI HOBUST.
LÄHEB ÄRA HOBUNE.
JÄÄB HOBUST.

ÜKS
KAKS
KOLM

PIIRA PARTIDE HULK JOONEGA. **ERALDA** JOONEGA PART, KES LENDAB ÄRA.

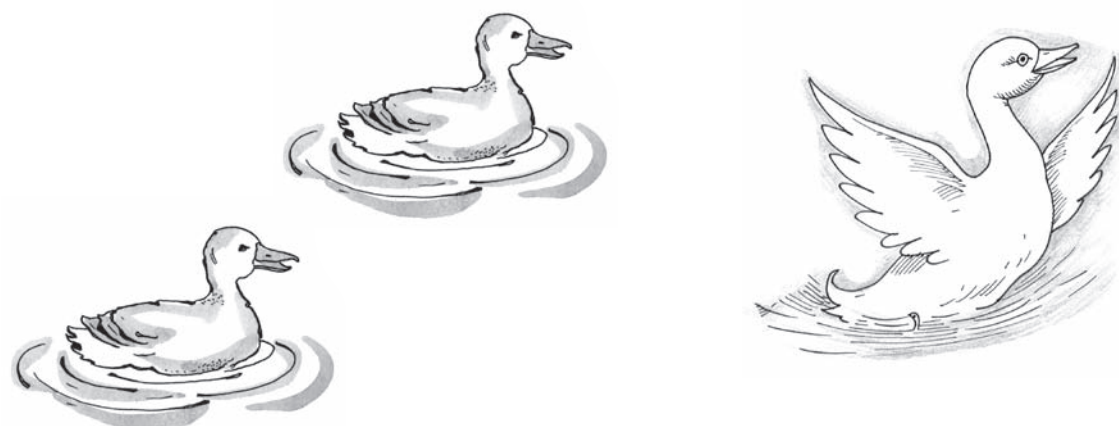

RÄÄGI.
OLI PARTI.
LENDAS ÄRA PARTI.
JÄÄB PARTI.

ÜKS
KAKS
KOLM
NELI

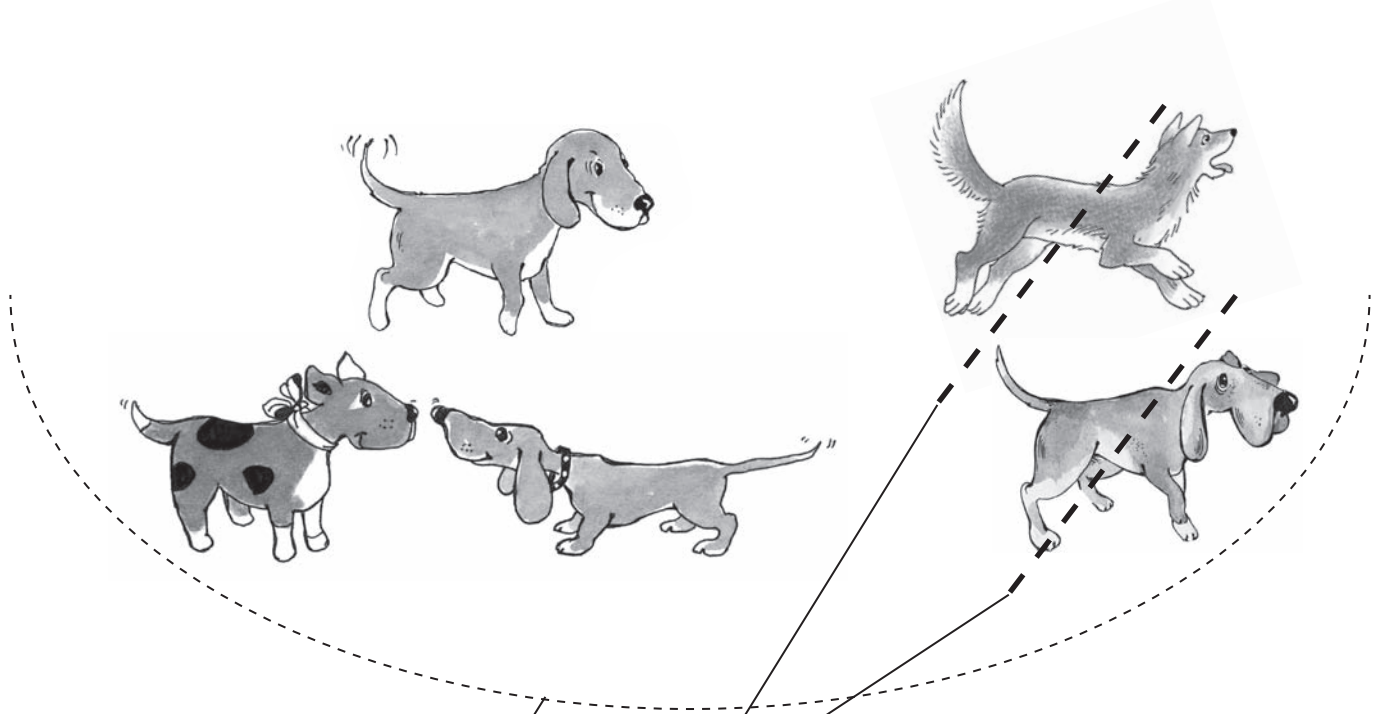

5	-	2	=	3
---	---	---	---	---

RÄÄGI.

OLI KOERA.
 LÄHEB ÄRA KOERA.
 JÄÄB JÄRELE KOERA.

-

 ON LAHUTAMIS+MÄRK.

LOE LAHUTAMIS+ÜLESANNET NII:

5	-	2	=	3
---	---	---	---	---

VIIS **MIINUS** KAKS **ON** KOLM.

JÄTKA RIDA.

-																			
-																			

ERALDA HULGAST VAJALIK ARV ESEMEID.

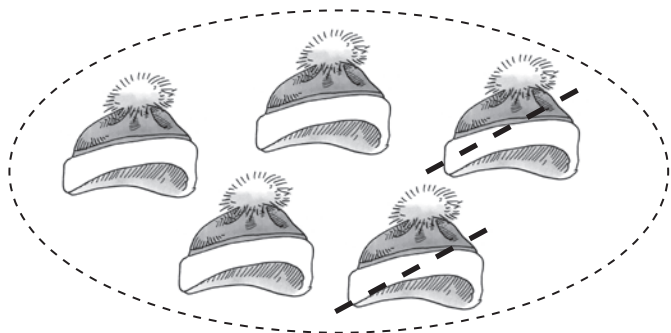

			2

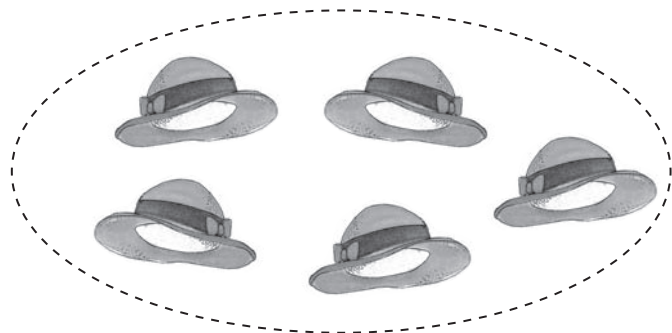

			4

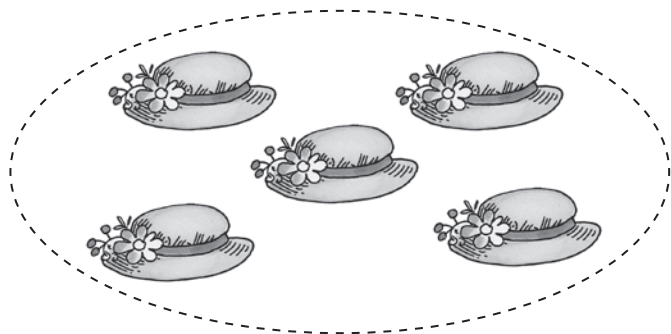

			3

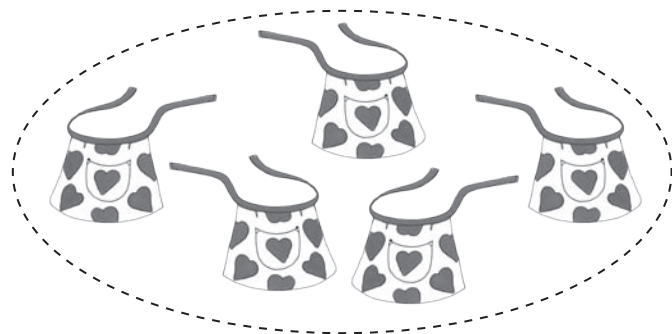

			2

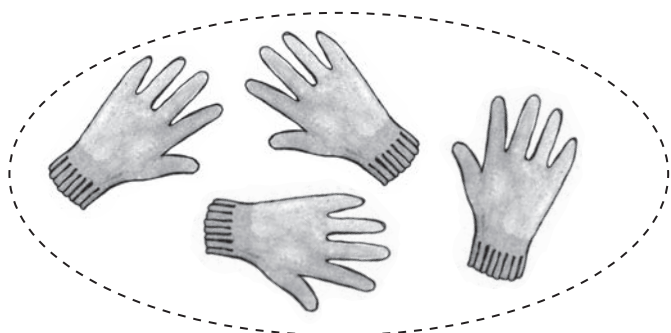

			2

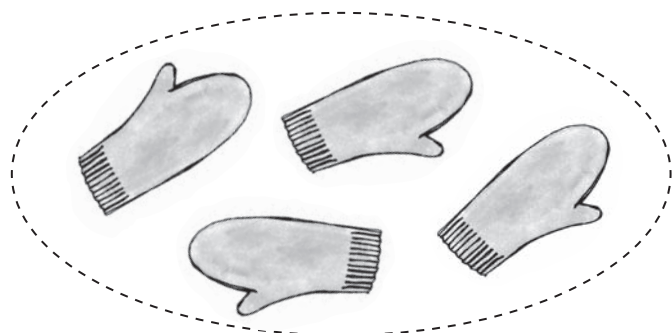

			4

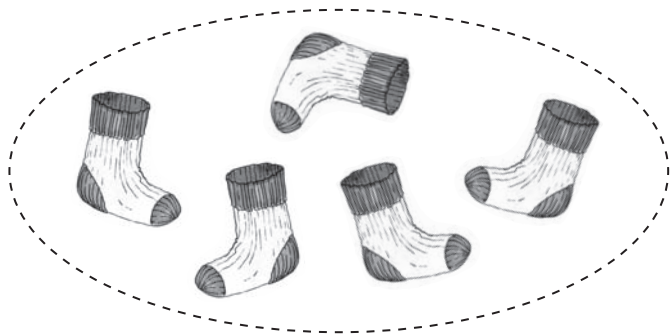

			5

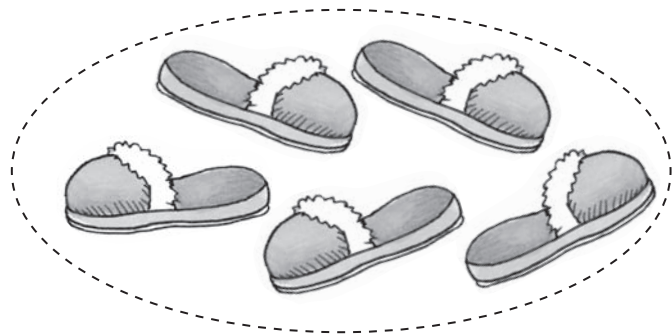

			3

KIRJUTA PILDID JÄRGI LAHUTAMIS+ÜLESANDESSE PUUDUV NUMBER.
 LOE LAHUTAMIS+ÜLESANDED.

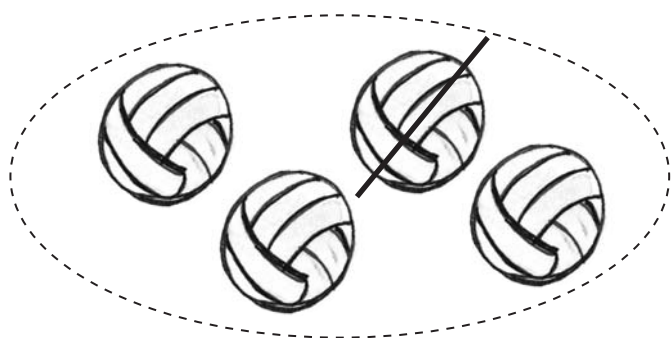

4	-	1		

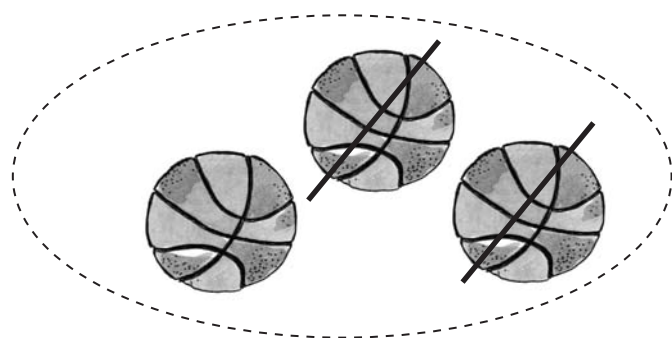

3	-			

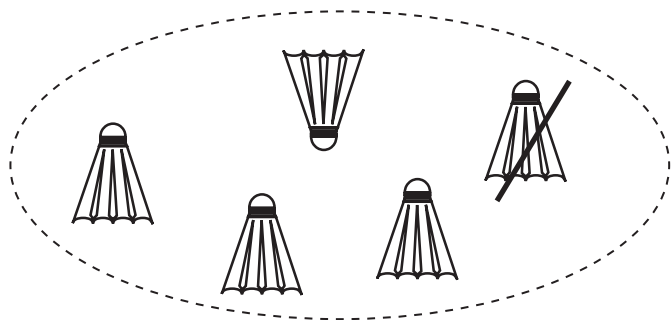

5	-			

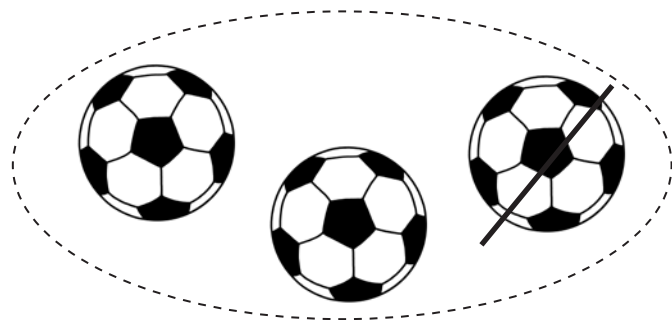

3	-			

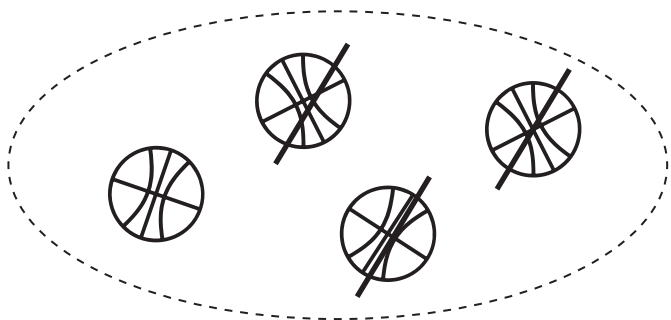

4	-			

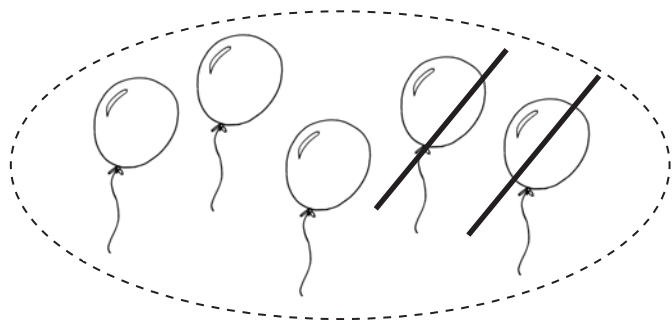

5	-			

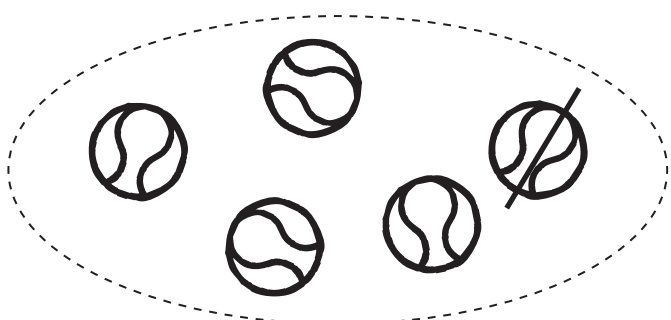

5	-			

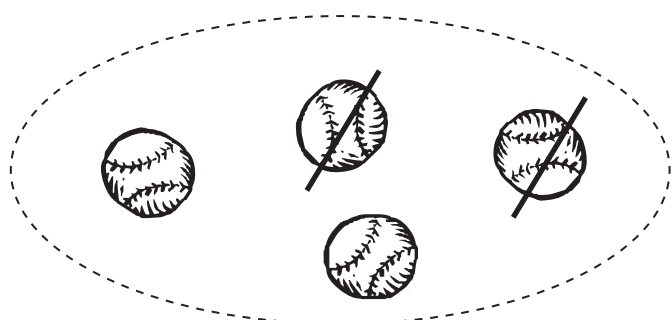

4	-			

JOONISTA LAHUTAMIS+ÜLESANDE JÄRGI VAJALIK ARV KUJUNDEID.
ARVUTA. LOE LAHUTAMIS+ÜLESANDED.

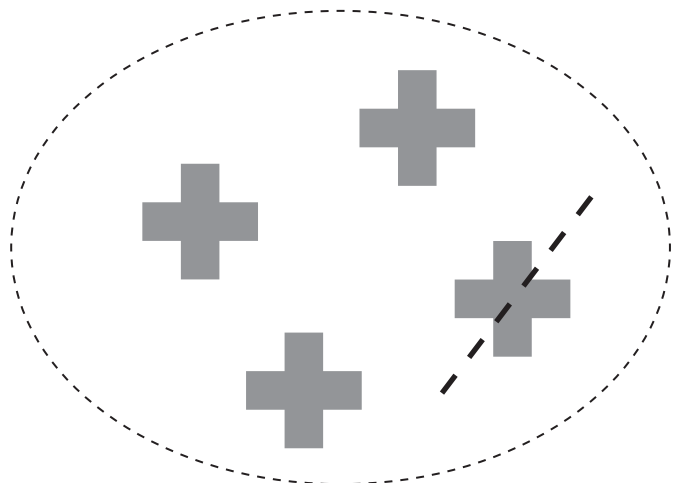

$$4 - 1 = \square$$

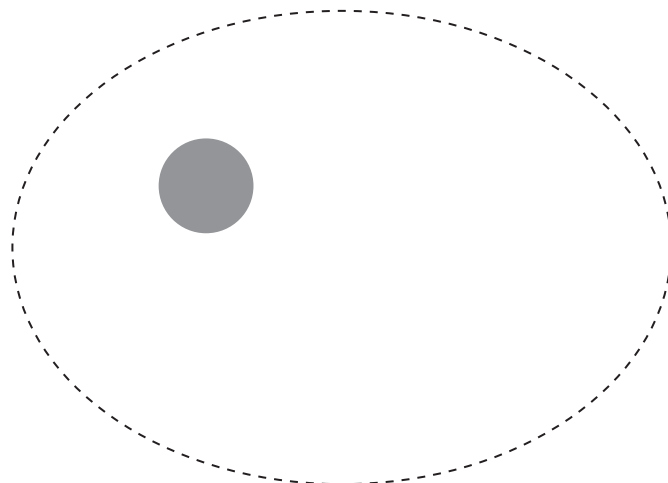

$$5 - 2 = \square$$

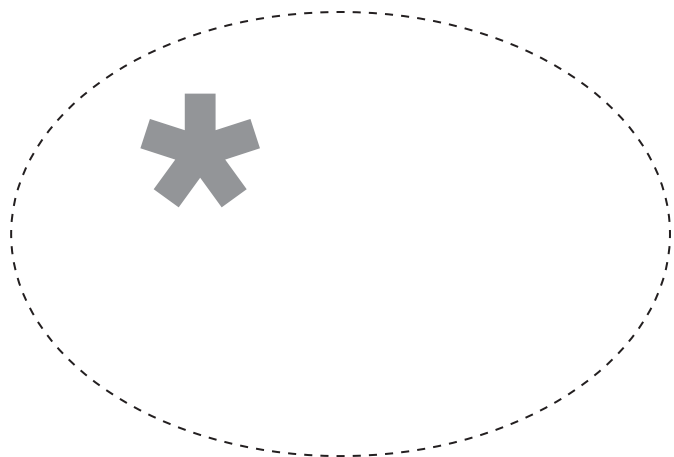

$$3 - 2 = \square$$

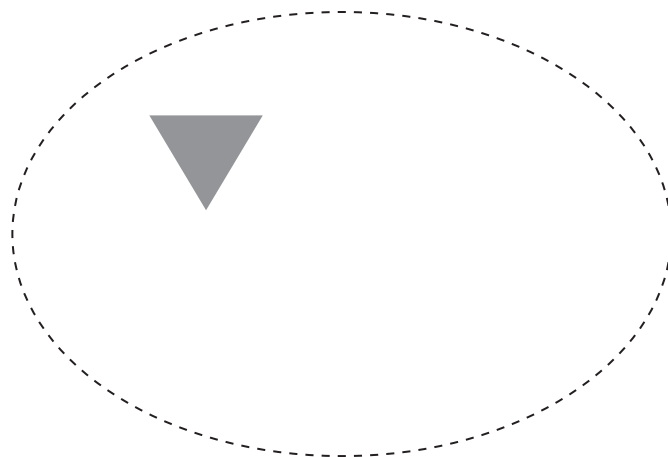

$$4 - 3 = \square$$

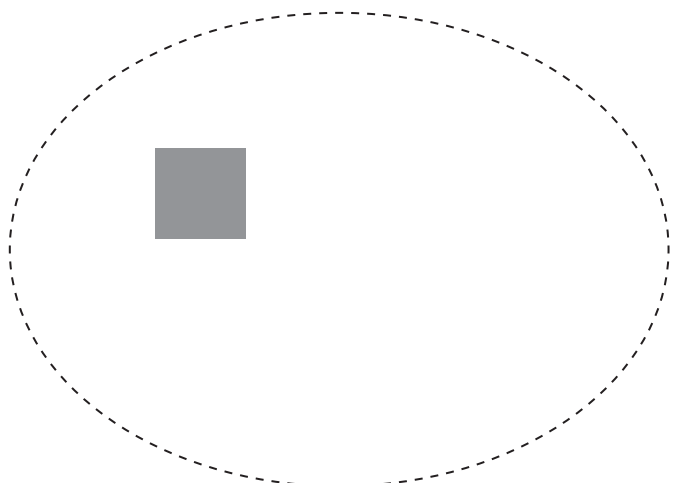

$$5 - 4 = \square$$

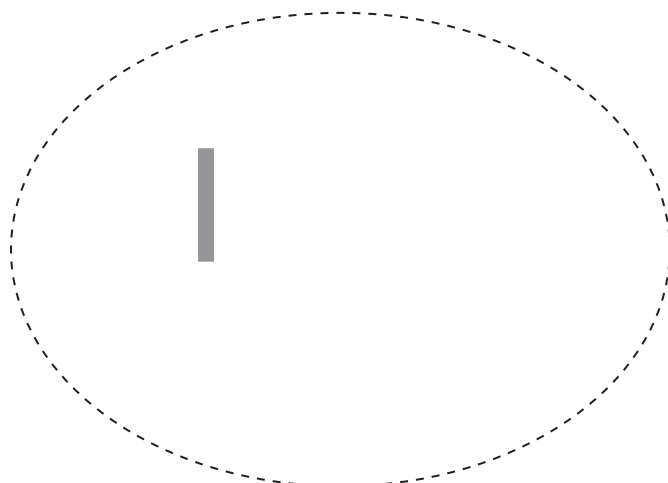

$$4 - 2 = \square$$

JOONISTA VAJALIK ARV KRIIPSE. LAHENDA ÜLESANNE.
KIRJUTA ÜLESANDE VASTUS.

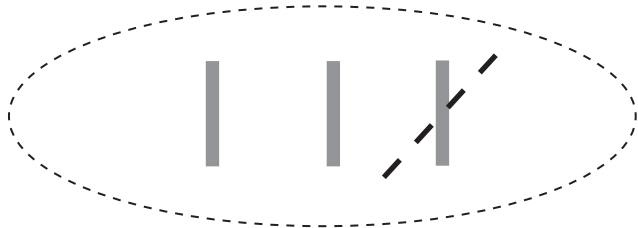

3	-	1	=	2
---	---	---	---	---

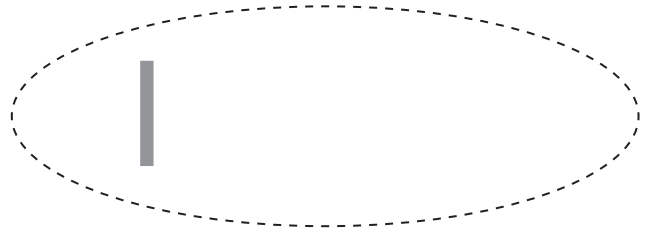

4	-	1	=	□
---	---	---	---	---

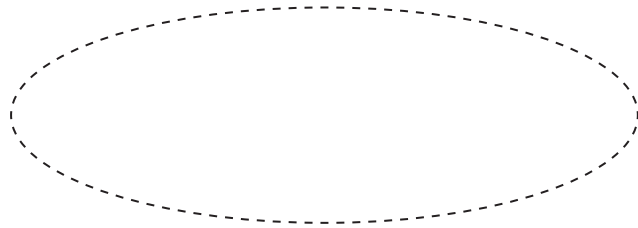

5	-	2	=	□
---	---	---	---	---

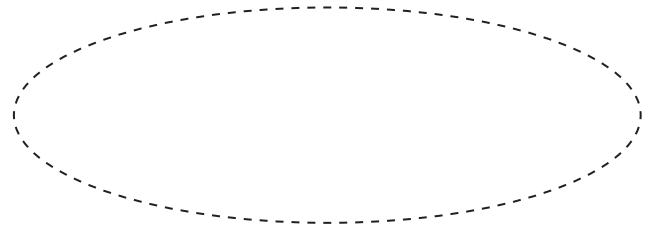

5	-	4	=	□
---	---	---	---	---

KIRJUTA PILDID JÄRGI LAHUTAMIS+ÜLESANNE. ARVUTA.



□	□	□	=	□
---	---	---	---	---

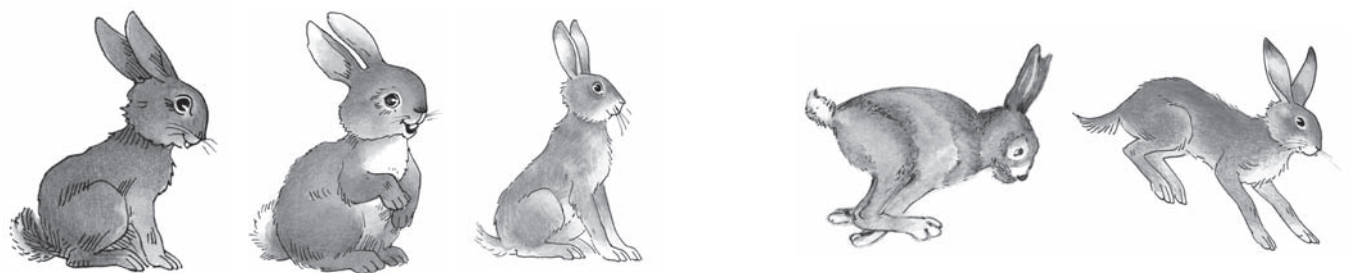

□	□	□	=	□
---	---	---	---	---

KIRJUTA PILDİ JÄRGI LAHUTAMIS+ÜLESANNE. ARVUTA.

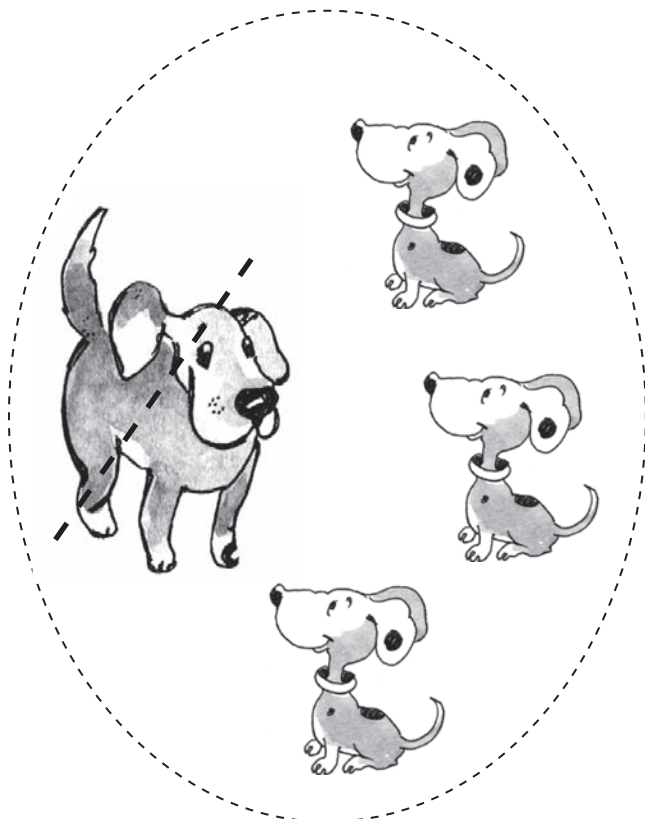

4	-	4	=		
---	---	---	---	--	--

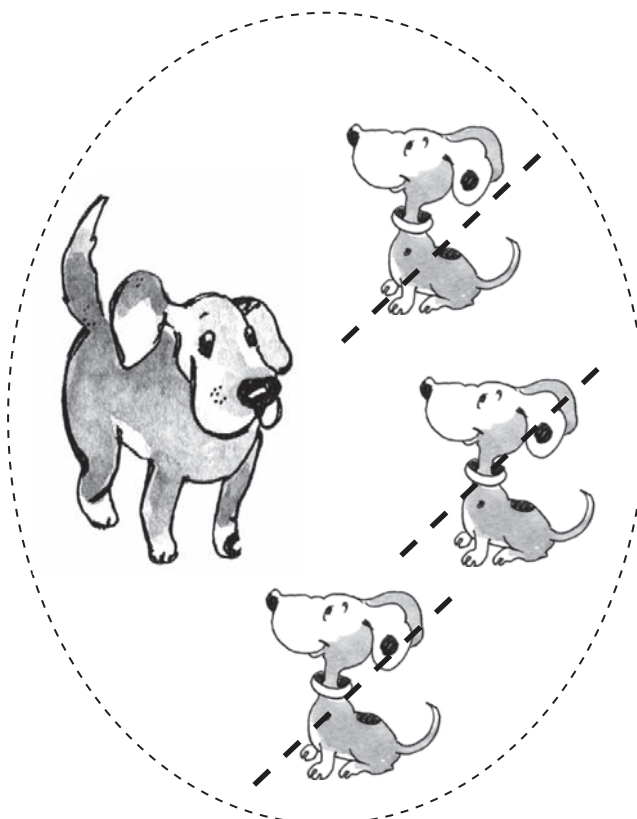

		-		=	
--	--	---	--	---	--

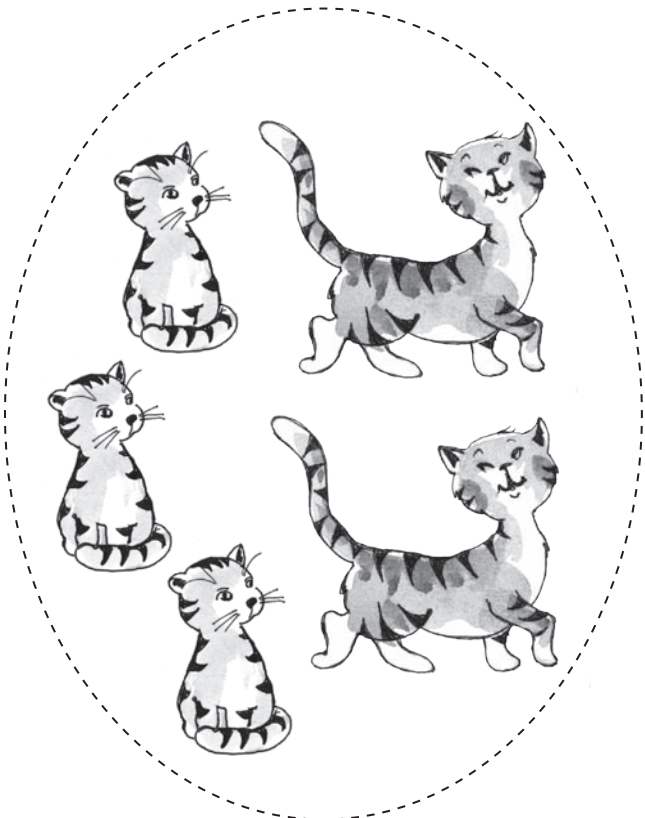

		-	2	=	
--	--	---	---	---	--

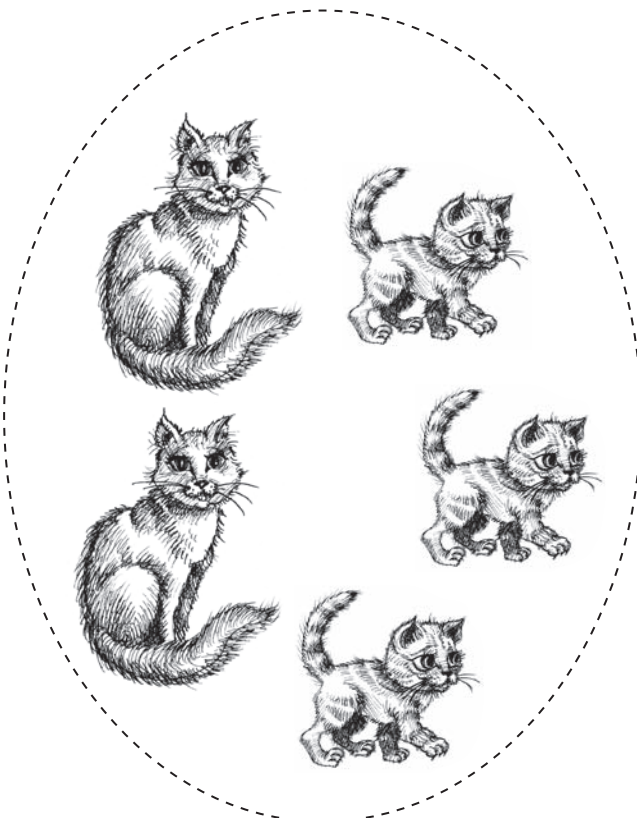

		-	3	=	
--	--	---	---	---	--

ARVUTA. ÜHENDA JOONEGA SARNASED ÜLESANDED.

LOE ÜLESANDED, MIS SA ÜHENDASID.

|||||
5 - 4 =

|||||
5 - 2 =

|||||
5 - 3 =

||||
4 - 3 =

||||
4 - 4 =

||||
5 - 4 =

KIRJUTA LAHUTAMIS+ÜLESANDE JÄRGI VEEL ÜKS LAHUTAMIS+ÜLESANNE.

3 - 4 = 2
3 - 2 = 4

5 - 4 =
 - =

5 - 2 =
 - =

4 - 4 =
 - =

KIRJUTA ÜLESANNE VIHIKUSSE. ARVUTA.

$$2 - 1$$

$$3 - 2$$

$$3 - 1$$

$$4 - 2$$

$$4 - 1$$

$$5 - 2$$

$$5 - 1$$

$$4 - 3$$

ARVUTA JA VÄRVI.

- 1 = SININE
- 2 = HELE+PRUUN
- 3 = PUNANE
- 4 = MUST



MITU PORGANDIT OLI?

MITU _____?

MITU _____?

OLI _____ .

_____ SÖÖB ÄRA.

NÜÜD ON _____ .



PORGANDIT

—



PORGANDIT

=



PORGANDIT

MITU _____?

MITU _____?

MITU _____?

OLI _____ .

_____ VIIB ÄRA _____ .

NÜÜD ON _____ .

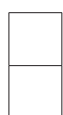
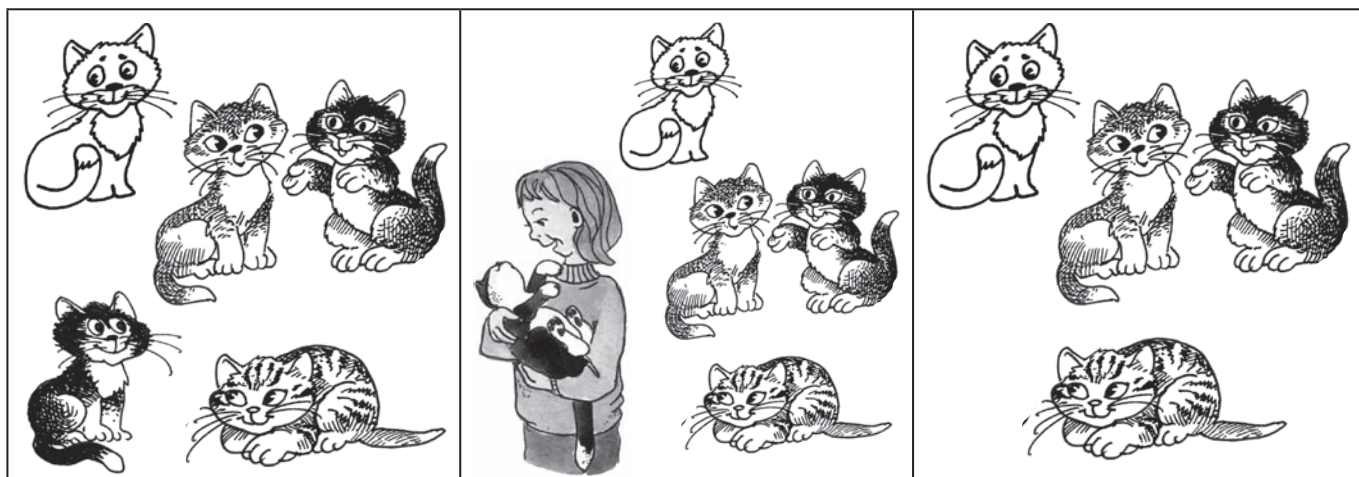

KASSI

—



KASS

=



KASSI

MÕTLE IGA PILDİ KOHTA KÜSIMUS. **KOOSTA** PILDİ JÄRGI ÜLESANNE. **KIRJUTA** PUUDUVAD NUMBRID. **LOE** ÜLESANDE LAHENDUS .

OLI _____ .

_____ SÖÖB ÄRA.

MITU _____ ?

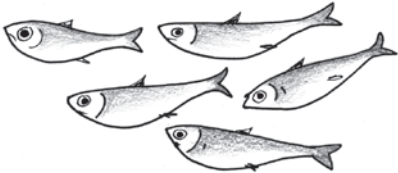
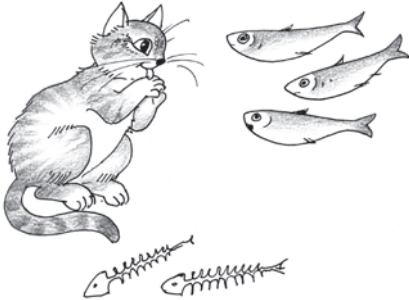
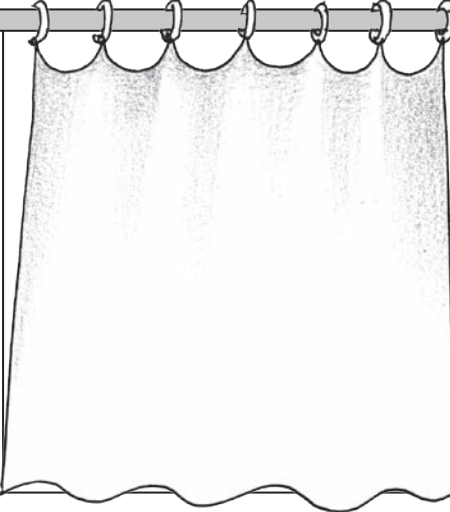
		
<input type="text"/> KALA	<input type="text"/> <input type="text"/> KALA	= <input type="text"/> KALA

OLI _____ .

_____ LÄHEB ÄRA.

MITU _____ ?

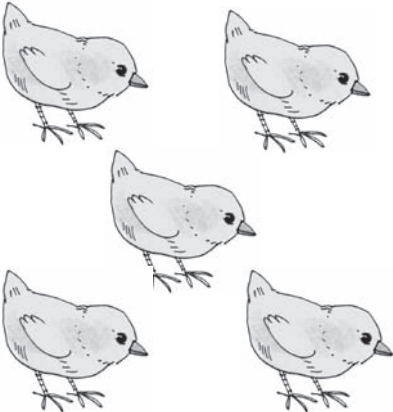
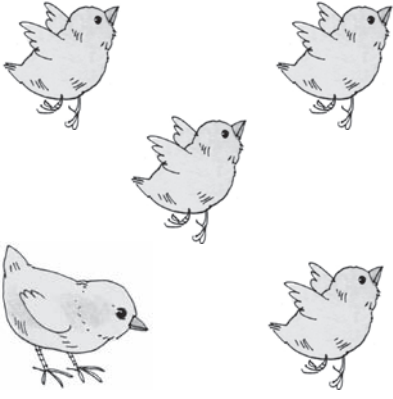
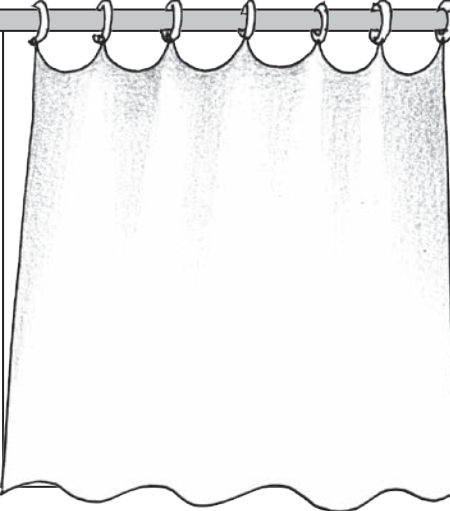
		
<input type="text"/> TIBU	<input type="text"/> <input type="text"/> TIBU	= <input type="text"/> TIBU

MÕTLE PEIDETUD PILDI KOHTA KÜSIMUS. **VALI** SOBIV TEHTE+MÄRK.
KOOSTA PILTIDE JÄRGI TEKST+ÜLESANNE.
KIRJUTA PUUDUVAD NUMBRID. **LOE** ÜLESANDE LAHENDUS.

PIIRA PILDID JUURDE SOBIV ÜLESANNE JOONEGA.

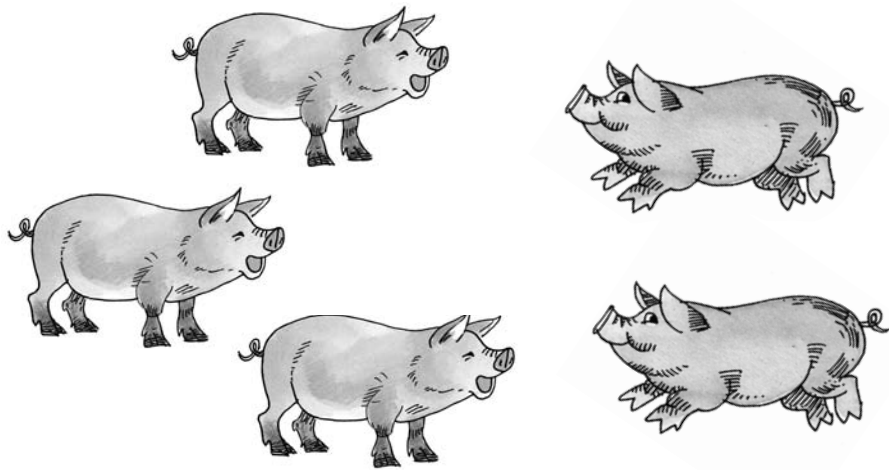

$$3 + 2$$

$$5 - 2$$

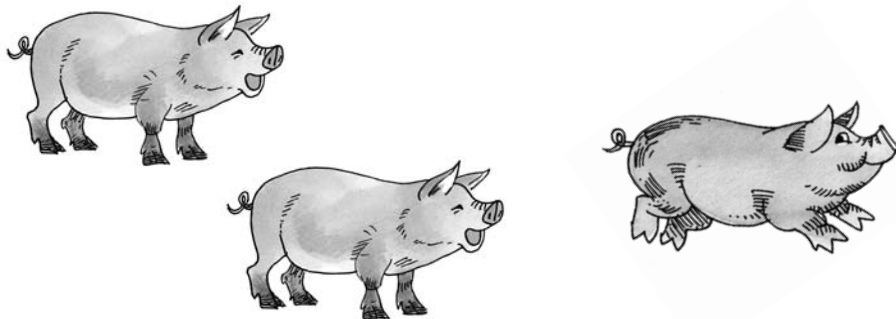

$$2 + 1$$

$$3 - 1$$

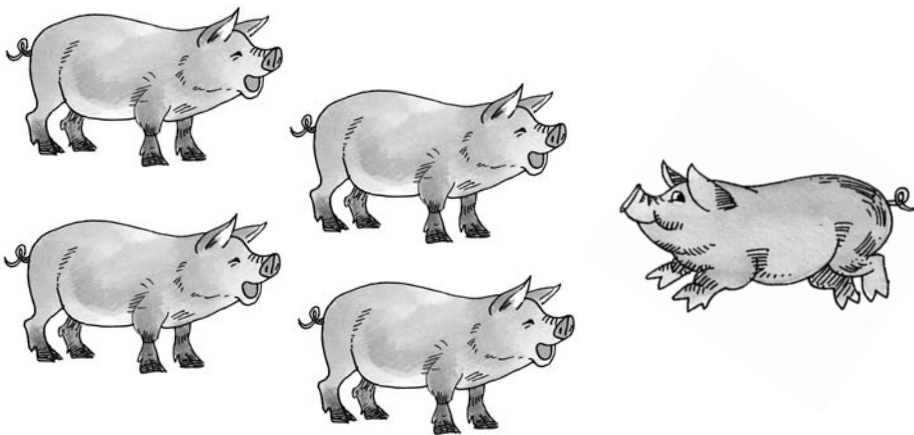

$$4 + 1$$

$$5 - 1$$

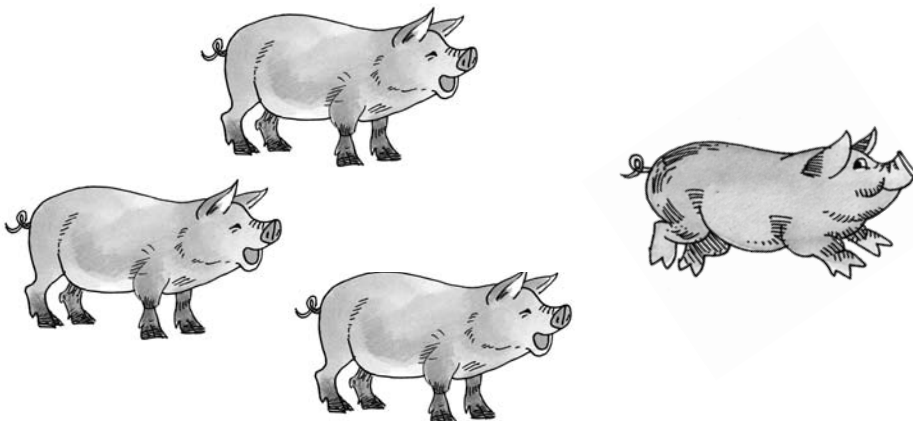

$$3 + 1$$

$$4 - 1$$

KOOSTA ÜLESANNE. ARVUTA.

KIRJUTA PUUDUVAD NUMBRID JA TEHTE+MÄRK.

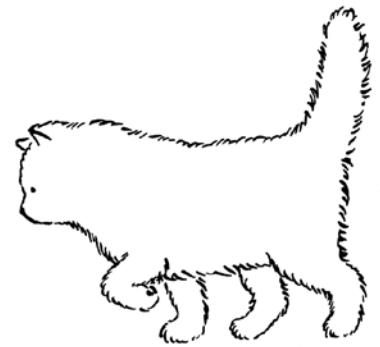
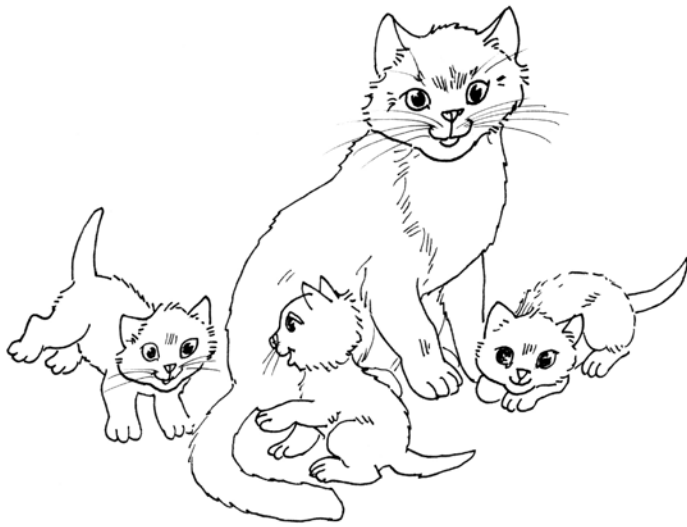

$$\begin{array}{|c|} \hline \\ \hline \\ \hline \end{array} \begin{array}{|c|} \hline \\ \hline \\ \hline \end{array} \begin{array}{|c|} \hline \\ \hline \\ \hline \end{array} = \begin{array}{|c|} \hline \\ \hline \\ \hline \end{array}$$

VÄRVI KASS, KES TULEB JUURDE.

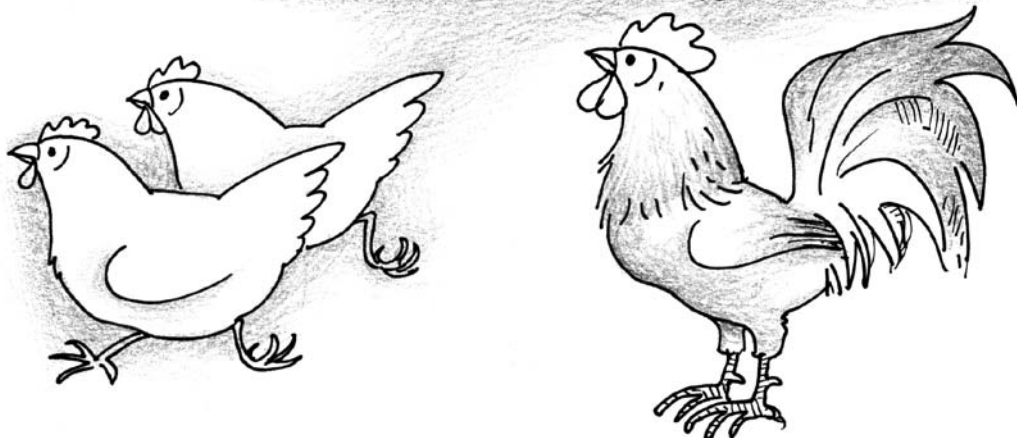
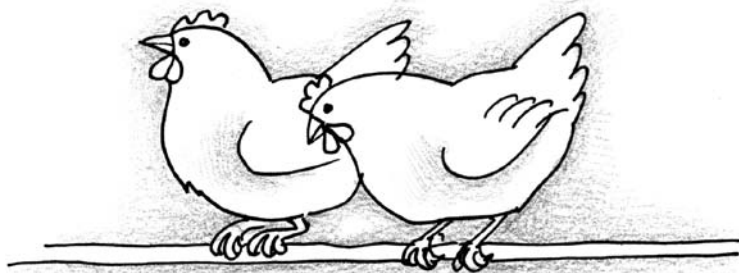

$$\begin{array}{|c|} \hline \\ \hline \\ \hline \end{array} \begin{array}{|c|} \hline \\ \hline \\ \hline \end{array} \begin{array}{|c|} \hline \\ \hline \\ \hline \end{array} = \begin{array}{|c|} \hline \\ \hline \\ \hline \end{array}$$

VÄRVI LINNUD, KES JÄÄVAD.

OLI _____ . _____ TULEB JUURDE. MITU _____ ?

_____ HOBUST _____ HOBUST = _____ HOBUST

OLI _____ . _____ PÜÜAB KINNI _____ . MITU _____ ?

_____ HIIRT _____ HIIRT = _____ HIIRT

KOOSTA PILDI JÄRGI TEKST+ÜLESANNE. **KIRJUTA** ÜLESANDE LAHENDUS. **ÜTLE** ÜLESANDE ANDMED, KÜSIMUS JA VASTUS.

AITA LEIDA ÕIGE PALL. ARVUTA. ÜHENDA JOONEGA.

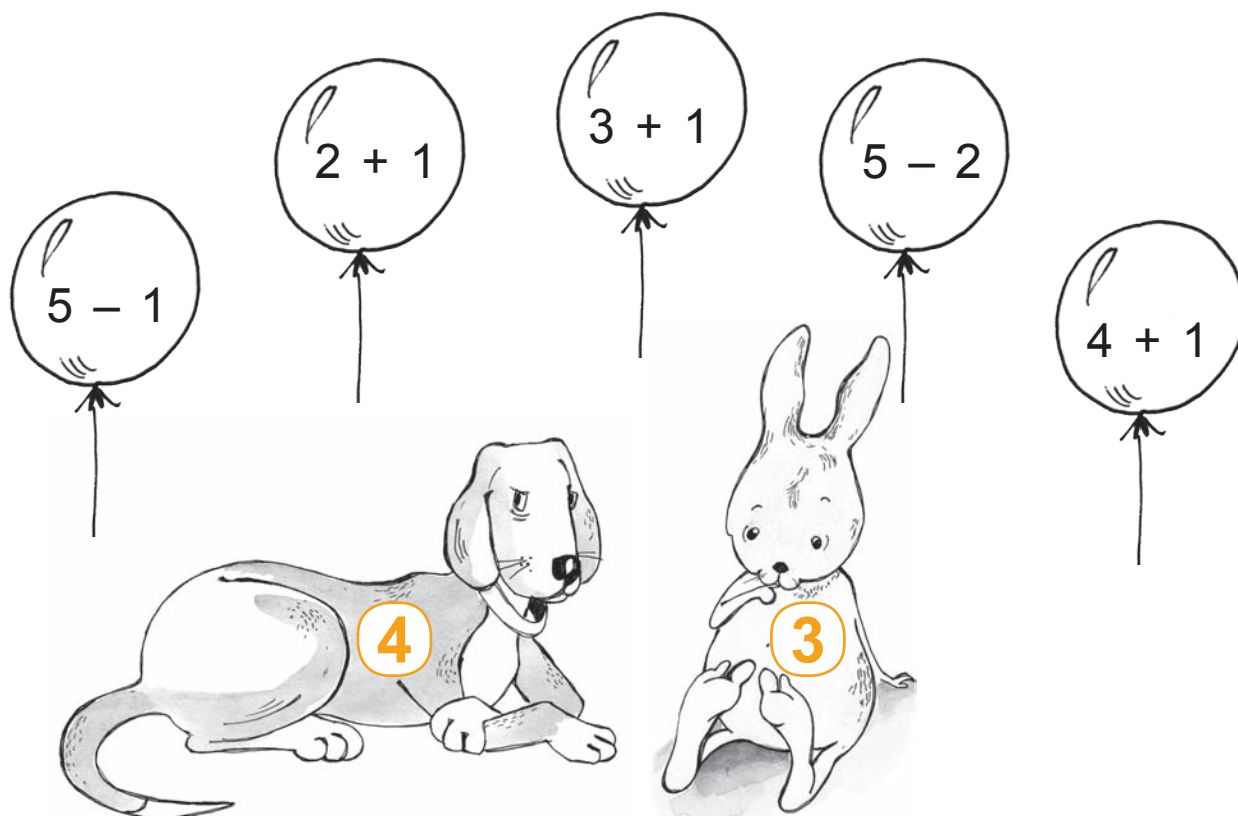

VÄRVI PALL, MIS JÄI ÜLE, ROHELISEKS.

ARVUTA. LEIA ARVU 1 TEE. MIDA SÖÖB JÄNES JUTA?

LEIA ARVU 5 TEE. MIDA SÖÖB JÄNES JUSS?

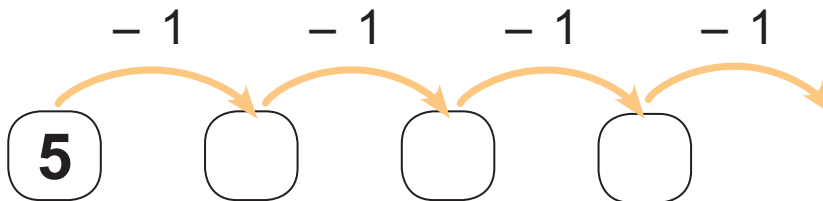
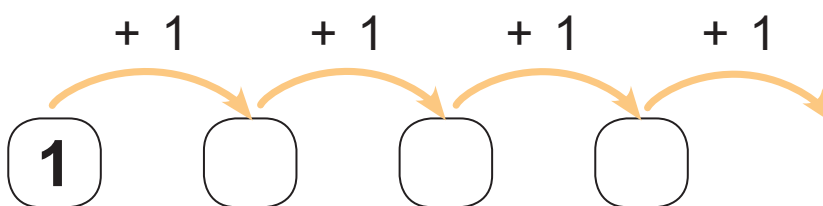

VÄRVI JÄNES JUTA HALLIKS JA JÄNES JUSS PRUUNIKS.

MIS ON KOERA NIMI? ARVUTA.

PIIRA JOONEGA VASTUSELE SOBIV TÄHT.

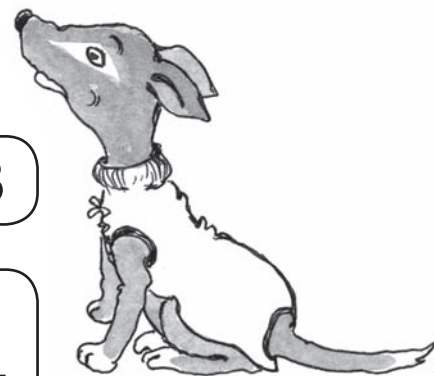

$4 - 1$

$3 + 2$

$3 + 1$

$5 - 3$

$3 = R$

$1 = U$

$2 = R$

$2 = I$

$5 = M$

$5 = O$

$4 = K$

$3 = E$

ARVUTA JA VÄRVI.

1 = PRUUN, 2 = KOLLANE, 3 = PUNANE, 4 = SININE, 5 = ROHELINE.

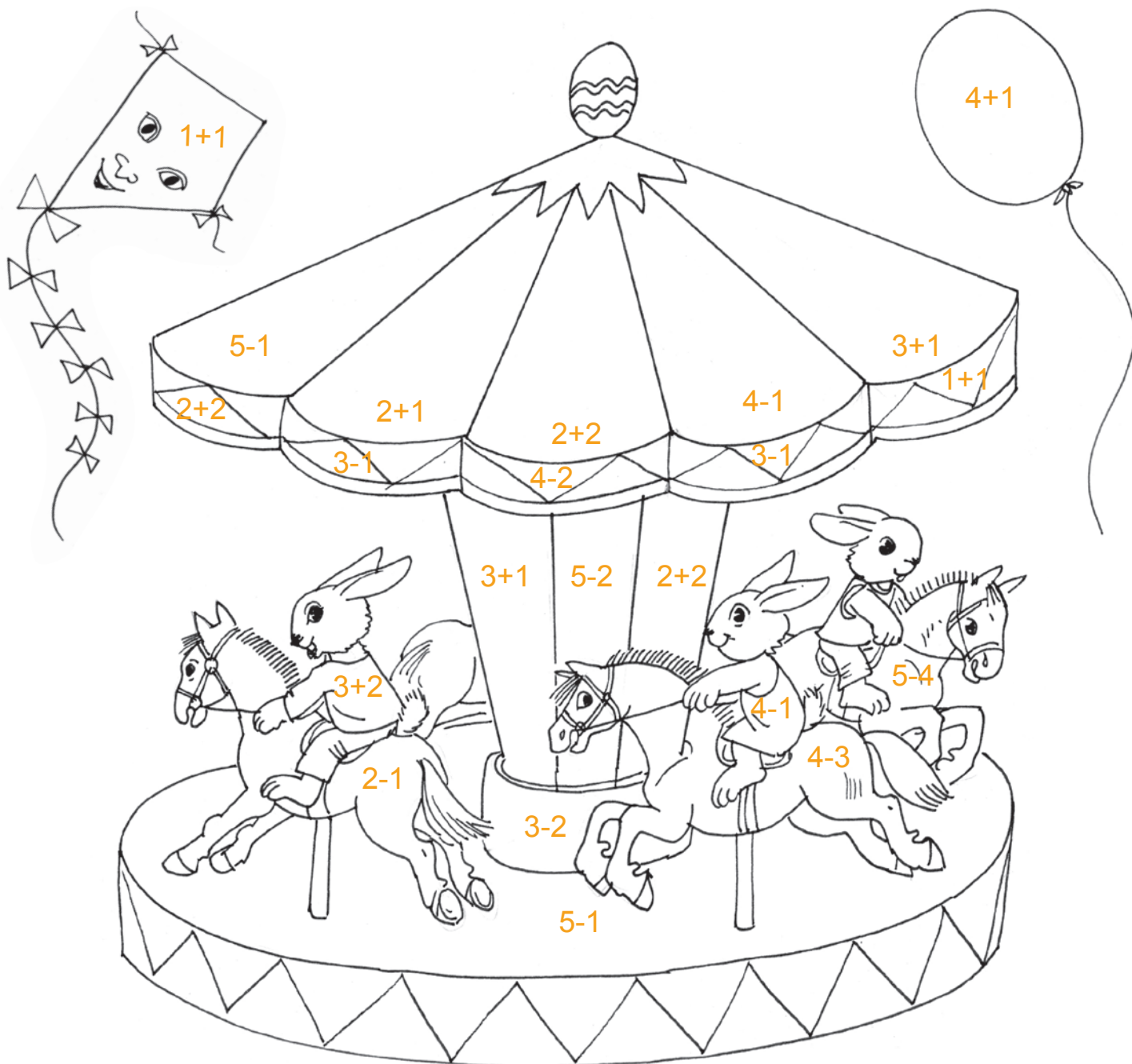

EURO



ÜKS EURO



KAKS EUROT



VIIS EUROT

MITU EUROT ON?



..... EUROT



..... EUROT



..... EUROT



..... EUROT

TÄIDA LÜNGAD.



..... EUROT

..... EUROT



..... EUROT

..... EUROT

MITU EUROT?



..... EUROT



..... EUROT



..... EUROT



..... EUROT

MITU EUROT ON ...

... ANNEL?



..... EUROT

... LAURIL?



..... EUROT

... LIISIL?



..... EUROT

... KAIEL?



..... EUROT

... MATIL?



..... EUROT

... SASSIL?



..... EUROT

ERALDA VAJALIK ARV EUROSID JOONE ABIL.

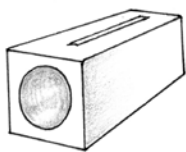

2 EUROT



2 EUROT



3 EUROT

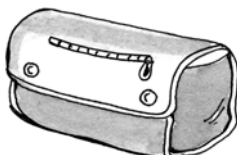

5 EUROT



4 EUROT

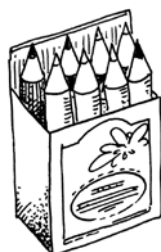

3 EUROT



KUI PALJU RAHA ON ...

... AINIL?



..... EUROT

... TIINAL?



..... EUROT

... TARMOL?



..... EURO

KUI PALJU MAKSAB ...

... KOOK?



2 EUROT

... JÄÄTIS?



1 EURO

... JOGURT?



3 EUROT

KES SAAB OSTA ...? PÕHJENDA.



TÕMBA MAHA SEE, MIDA LAPS OSTA EI SAA.

0 NULL



$$5 - 4 = \square$$

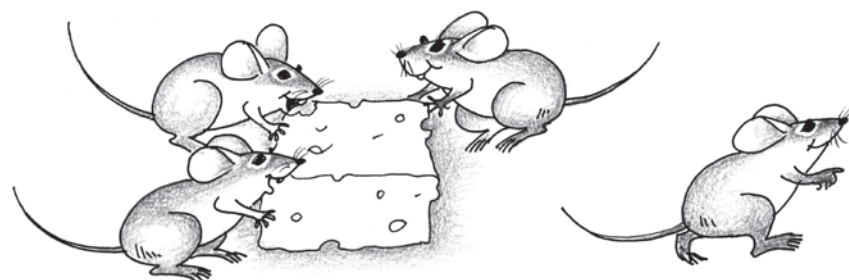

$$\square - \square = \square$$



$$\square - \square = \square$$

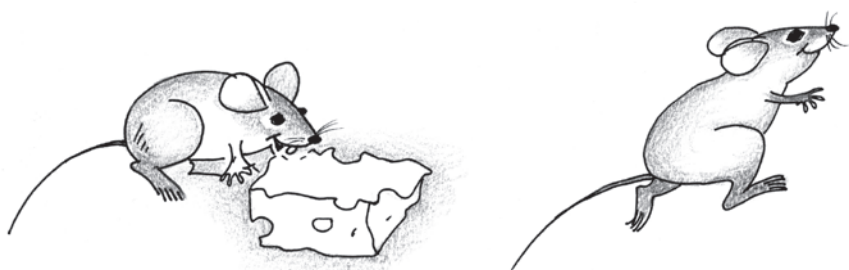

$$\square - \square = \square$$

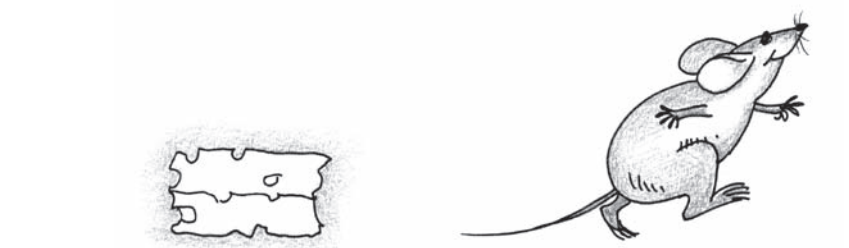

$$\square - \square = \square$$

KIRJUTA PUUDUVAD ARVUD.

VÄRVI PILTIDEL NEED HIRED, KES JÄÄVAD JUUSTU SÖÖMA.

JÄTKA RIDA.

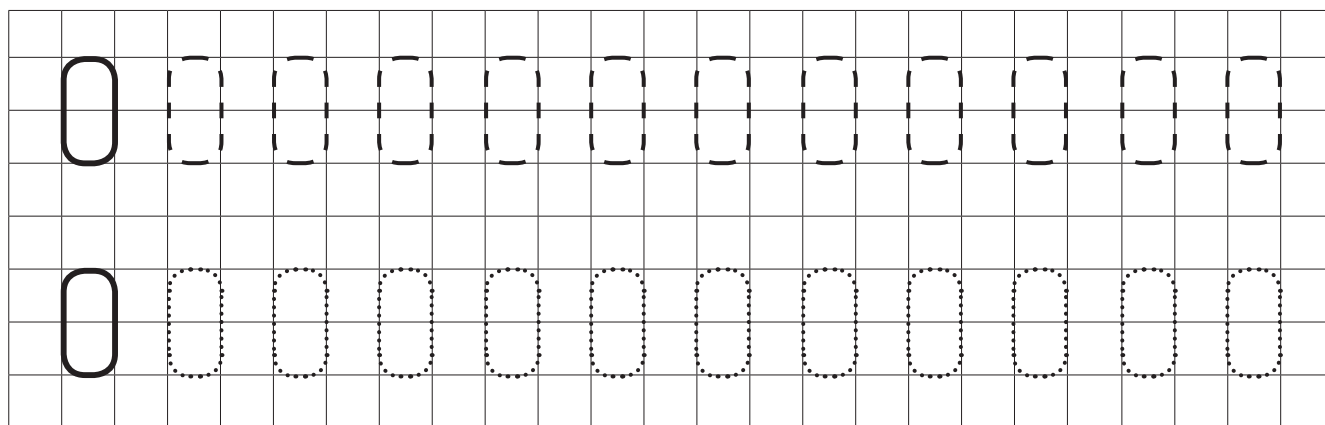

PIIRA HULGAD JOONEGA. KIRJUTA PUUDUVAD ARVUD.

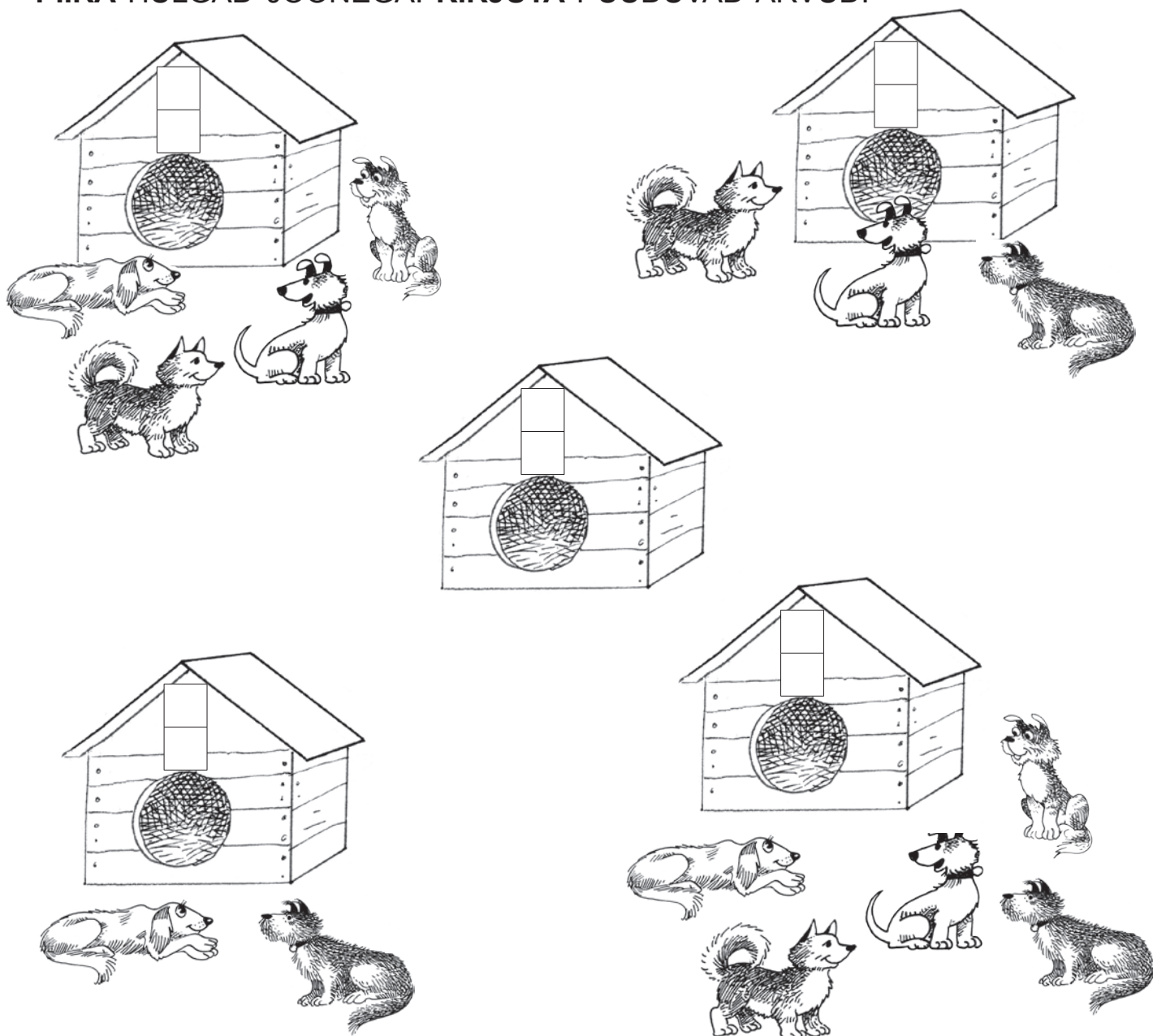

VÖRDLE HULKI JA ARVE. KIRJUTA PUUDUVAD ARVUD JA MÄRGID.

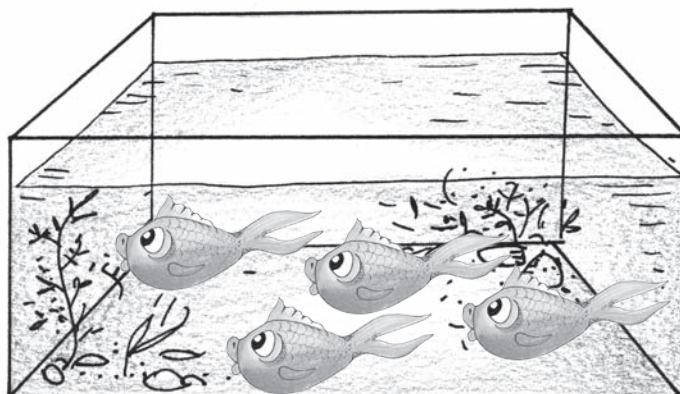
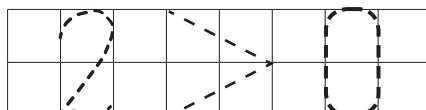
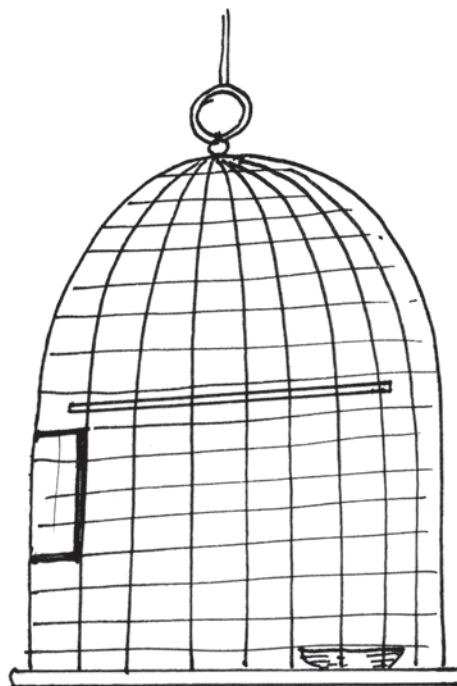
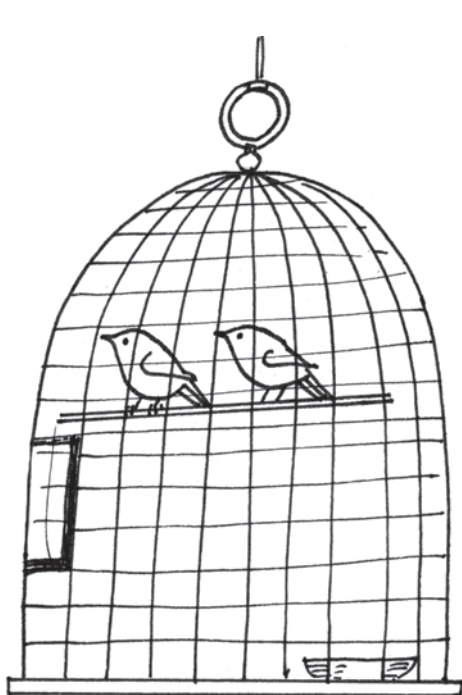

VÄRVI VAJALIK ARV RUUTE. VÖRDLE HULKI JA ARVE.

KIRJUTA PUUDUVAD ARVUD JA MÄRGID.

5				0

4				0

0				3

3				0

1				0

0				2

KIRJUTA PUUDUVAD ARVUD. LOE.

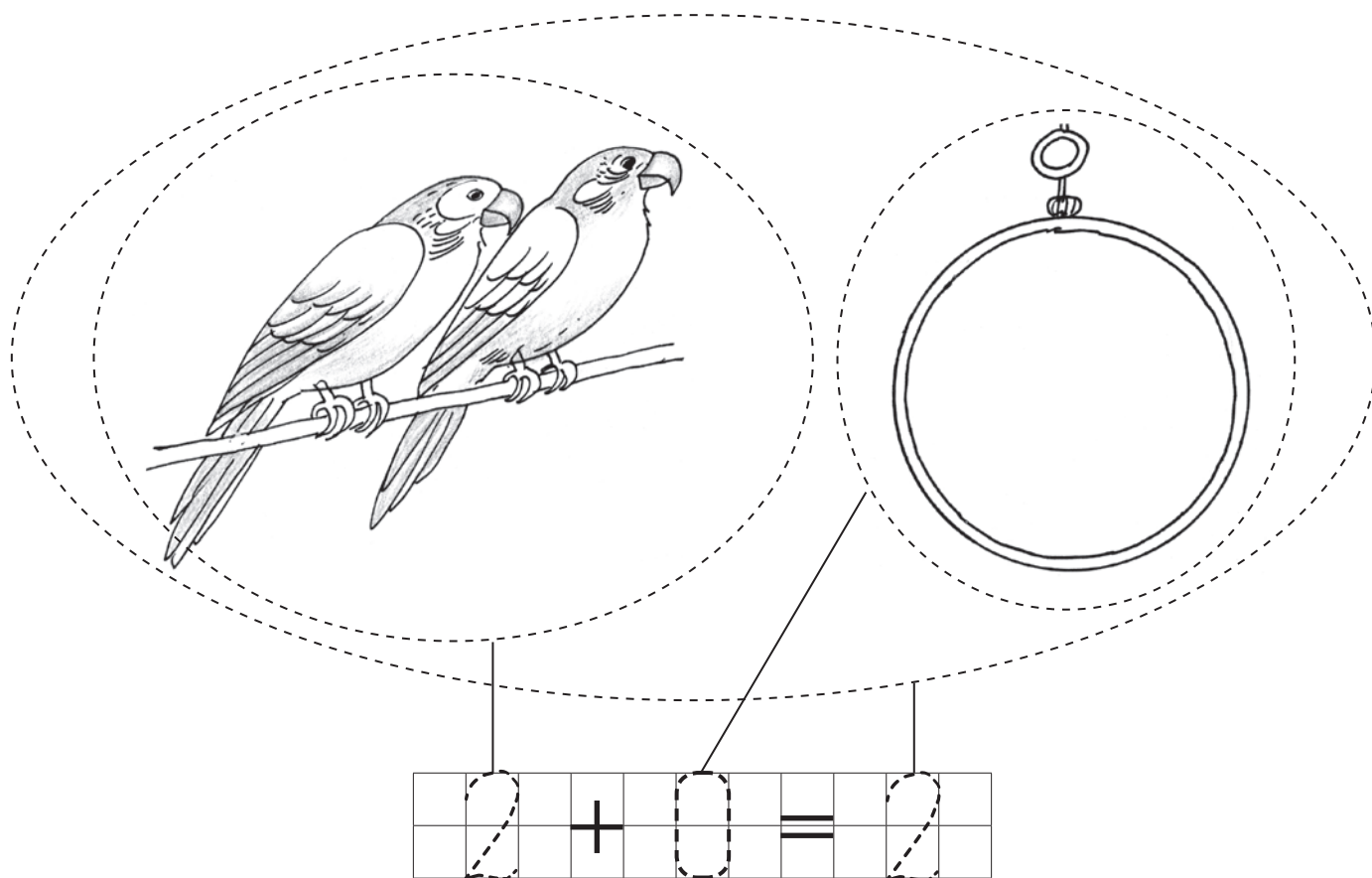

MITU PAPAGOID ISTUB PULGAL?

MITU PAPAGOID ISTUB RÕNGAL?

MITU PAPAGOID ON KOKKU?

JOONISTA VAJALIK ARV KRIIPSE. ÜHENDA HULGAD. LOE.

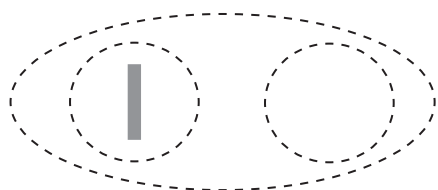

$$1 + 0 = \square$$

$$4 + 0 = \square$$

$$3 + 0 = \square$$

$$5 + 0 = \square$$

KIRJUTA PUUDUVAD ARVUD. LOE.

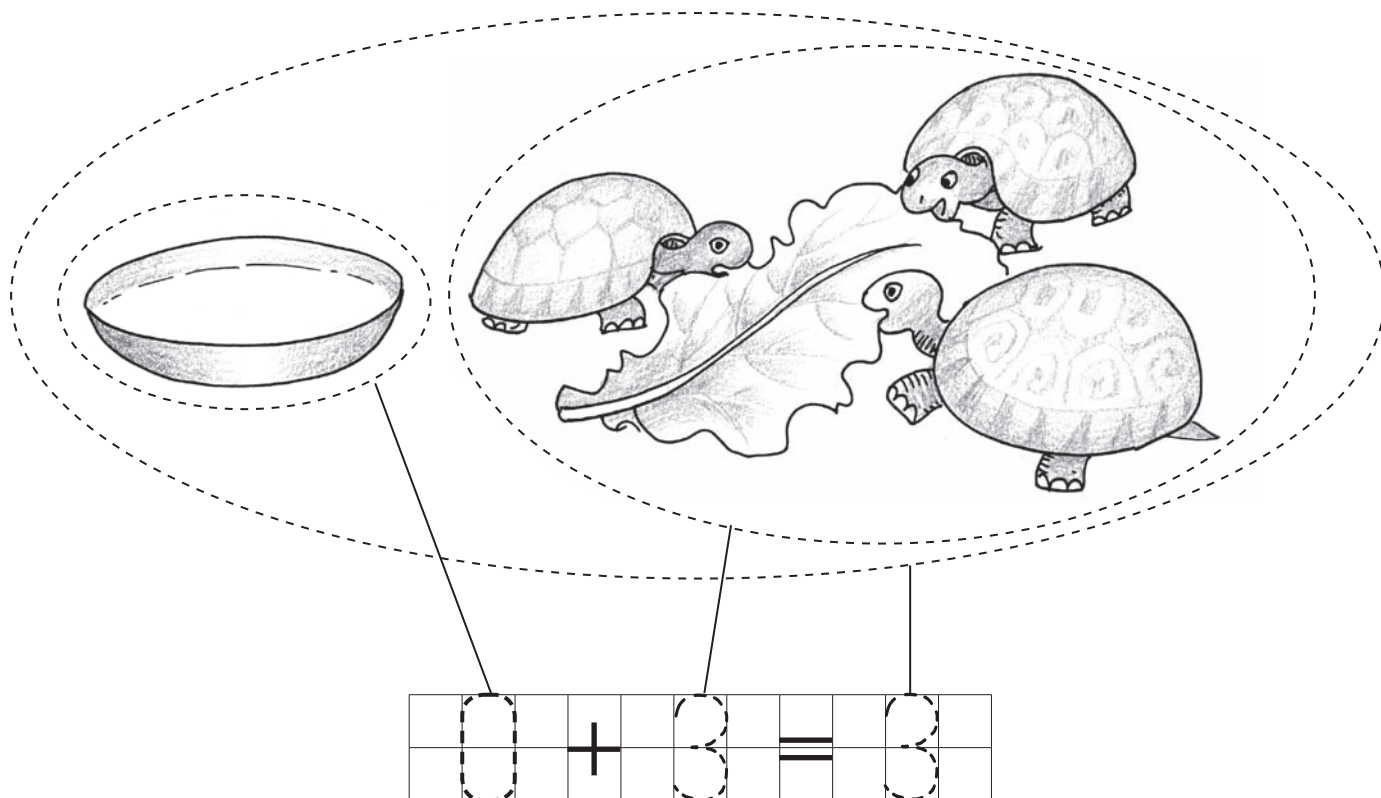

MITU KILP+KONNA SÖÖB?

MITU KILP+KONNA JOOB?

MITU KILP+KONNA ON KOKKU?

JOONISTA VAJALIK ARV KRIIPSE. ÜHENDA HULGAD. ARVUTA.

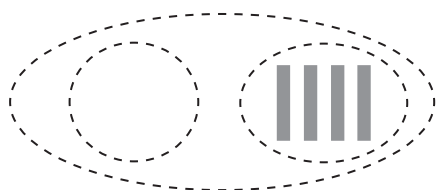

$$0 + 4 = \square$$

$$0 + 1 = \square$$

$$0 + 2 = \square$$

$$0 + 5 = \square$$

KIRJUTA PILDID JÄRGI LAHUTAMIS+ÜLESANNE. LOE.

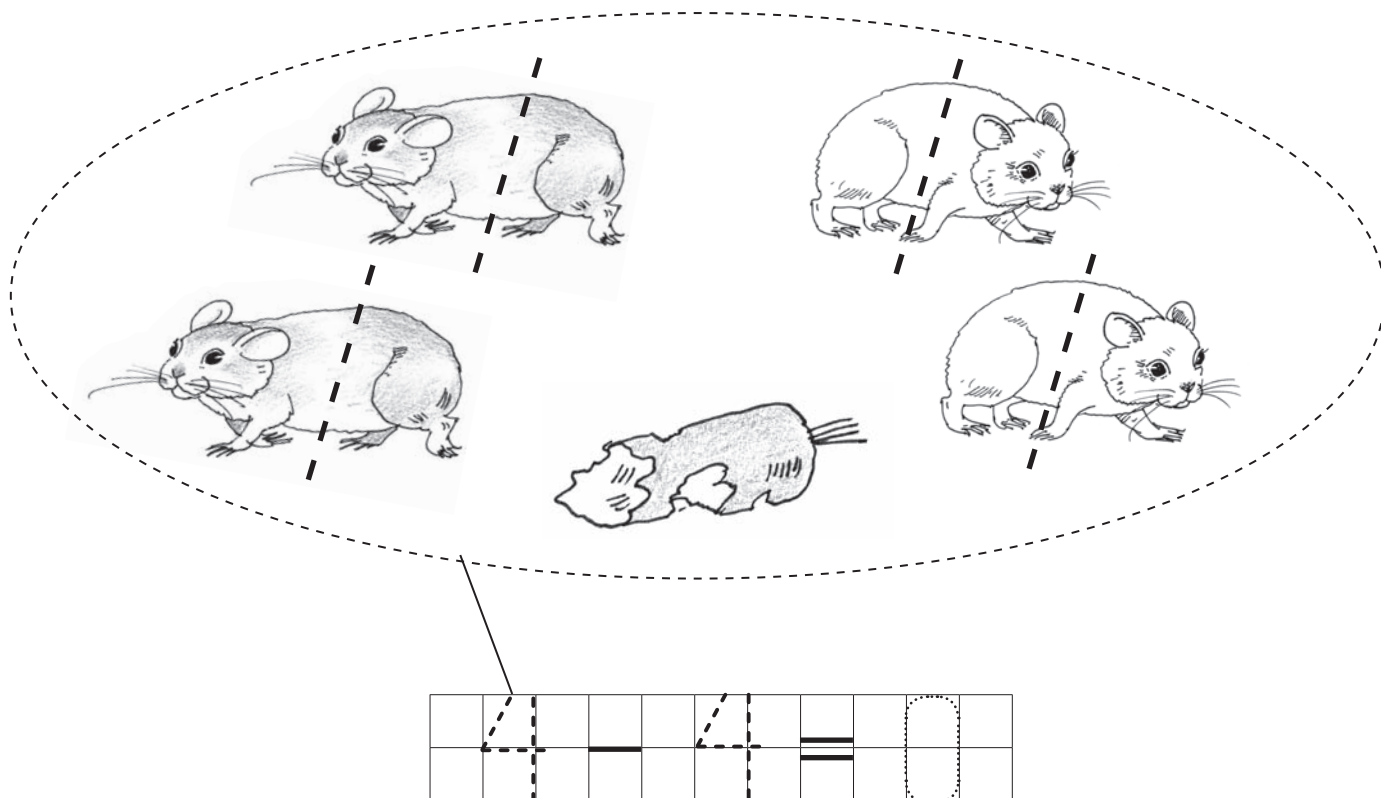

MITU HAMSTRIT OLI?

MITU HAMSTRIT LÄHEB ÄRA?

MITU HAMSTRIT JÄÄB JÄRELE?

JOONISTA VAJALIK ARV KRIIPSE. ARVUTA.

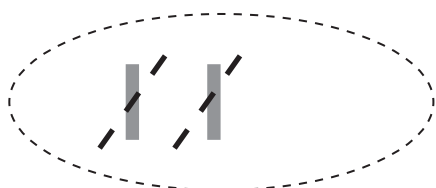

$$2 - 2 = \square$$



$$5 - 5 = \square$$



$$3 - 3 = \square$$



$$4 - 4 = \square$$

KIRJUTA ÜLESANNE VIHIKUSSE. ARVUTA.

$2 + 0$

$0 + 5$

$4 - 4$

$1 - 1$

$0 + 3$

$4 + 0$

$5 - 5$

$2 - 2$

KOOSTA PILDI JÄRGI ÜLESANNE. KIRJUTA PUUDUVAD ARVUD.
ARVUTA.

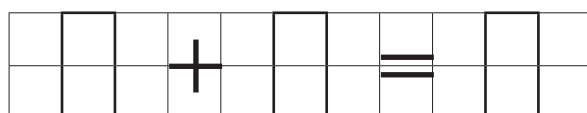
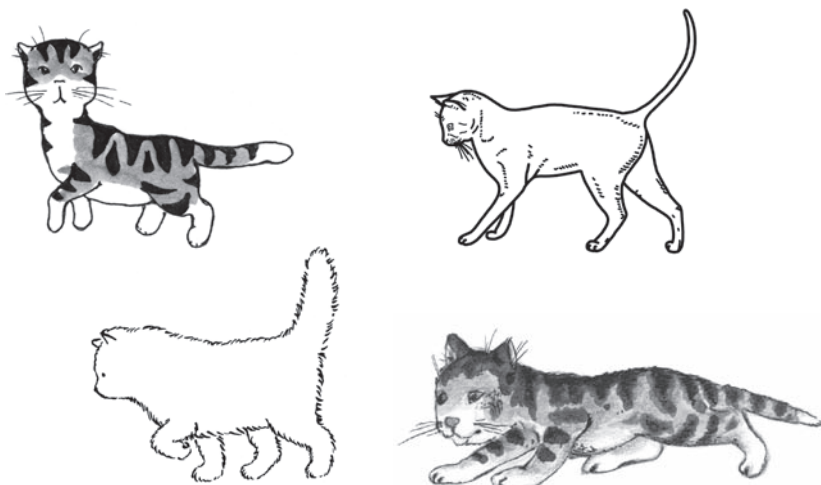
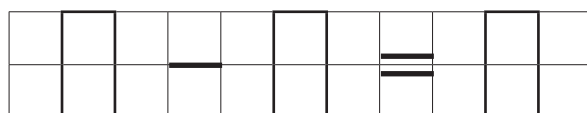
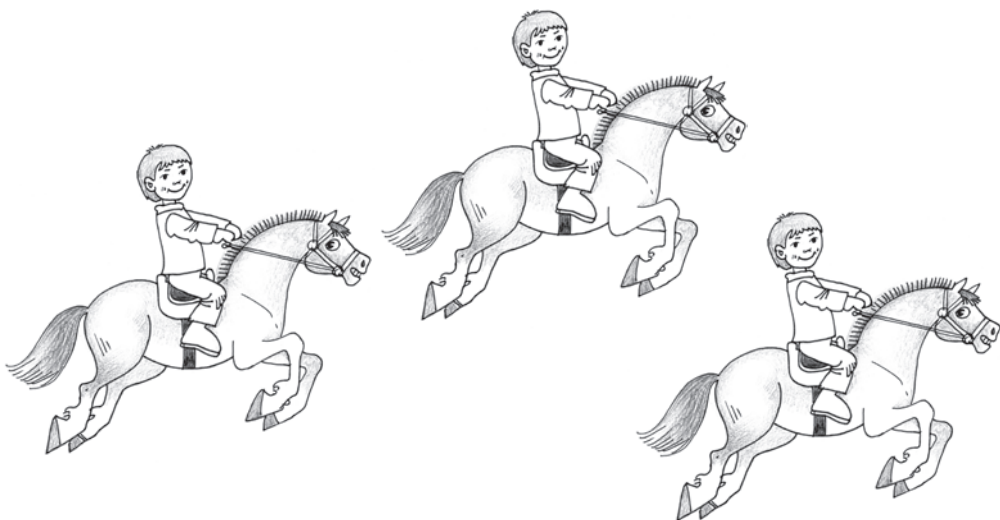
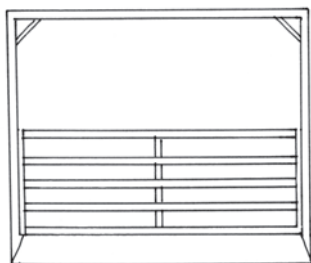

OLI _____ .

_____ LENDAB ÄRA.

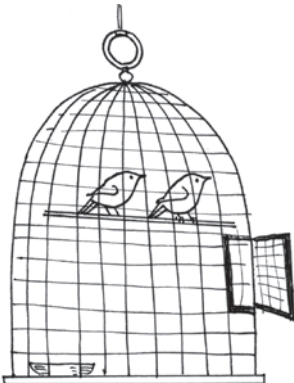
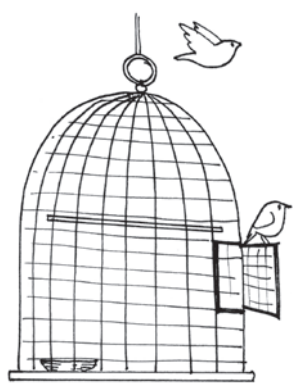
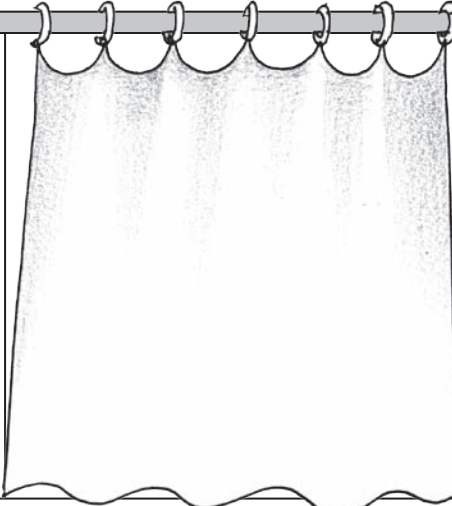

MITU _____ ?

		
<input type="text"/> LINDU	<input type="text"/> <input type="text"/> LINDU	= <input type="text"/> LINDU

OLI _____ .

_____ PANEB JUURDE _____ .

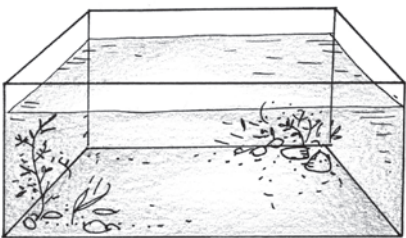
MITU _____ ?

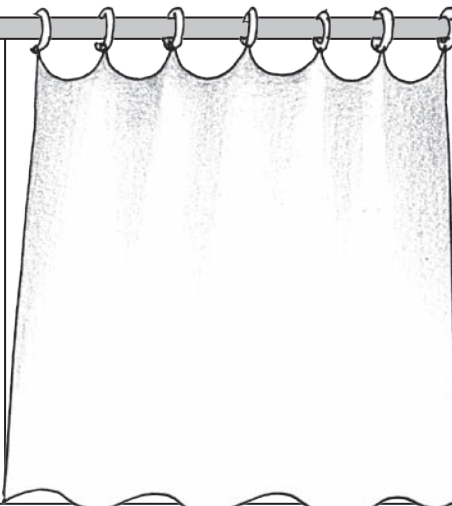
		
<input type="text"/> KALA	<input type="text"/> <input type="text"/> KALA	= <input type="text"/> KALA

KOOSTA PILTIDE JÄRGI TEKST+ÜLESANNE. **KIRJUTA** ÜLESANDE LAHENDUS. **ÜTLE** ÜLESANDE ANDMED, KÜSIMUS JA VASTUS.

SISUKORD

ARV JA NUMBER 1	3
ARV JA NUMBER 2	7
MITMES?	16
MITU? MITMES?	17
ARV JA NUMBER 3	19
MITMES?	39
MITU? MITMES?	40
ARV JA NUMBER 4	44
MITU? MITMES?	57
KEVAD SUVI SÜGIS TALV	59
ARV JA NUMBER 5	73
MITU? MITMES?	85
EURO	112
ARV JA NUMBER 0	117



Euroopa Liit
Euroopa Sotsiaalfond



Eesti tuleviku heaks



Hariduslike erivajadustega
õpilaste õppevara arendamine

ISBN 978-9949-513-69-7

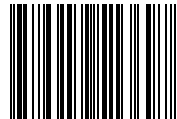

9 789949 513697