

Signe Leht

# MATEMAATIKA IV

## Kaal. Raha. Kell

*Töölehtede komplekt*

*Toimetulekuõppe II–III arengutase*

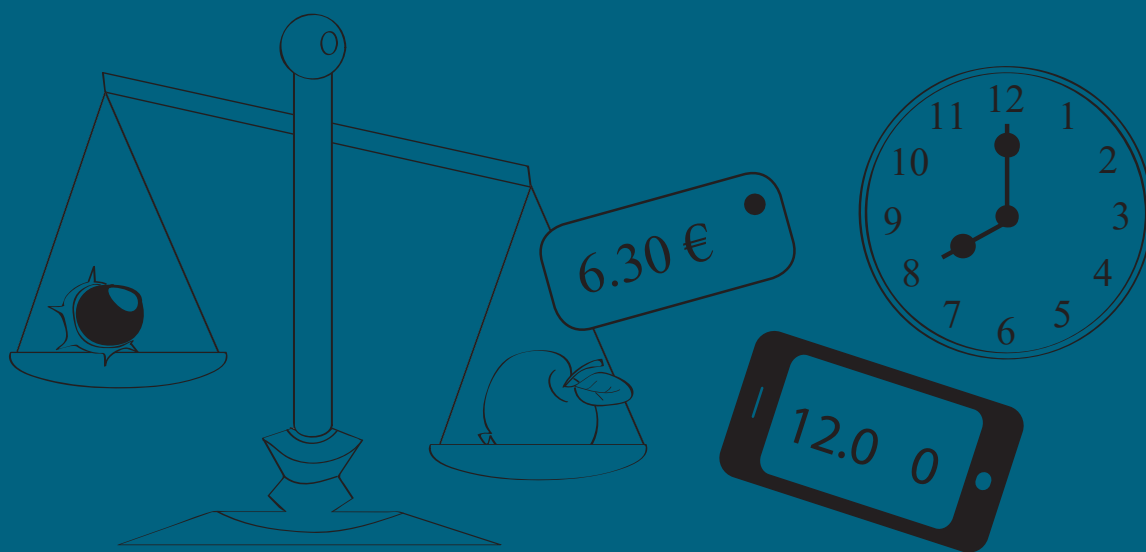

**Signe Leht**

# **MATEMAATIKA IV**

**Kaal. Raha. Kell**

TÖÖLEHTEDE KOGUMIK

201(

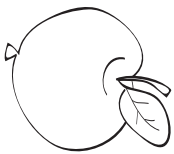
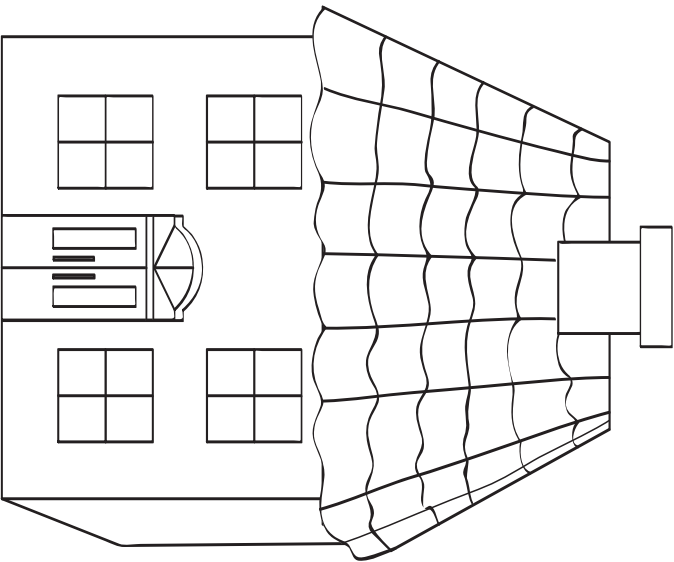
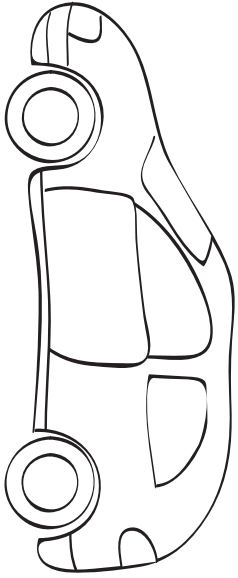
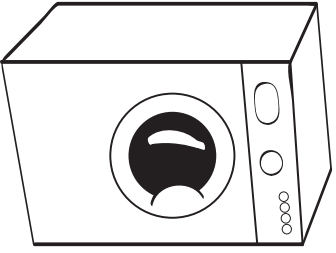

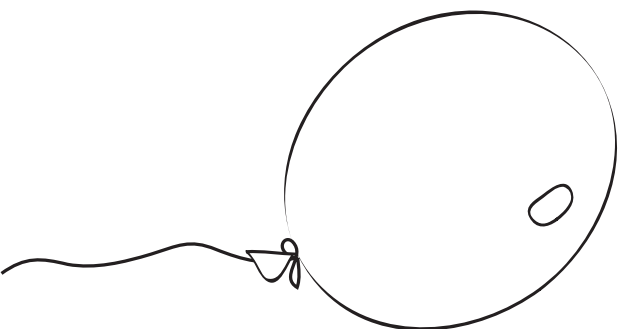
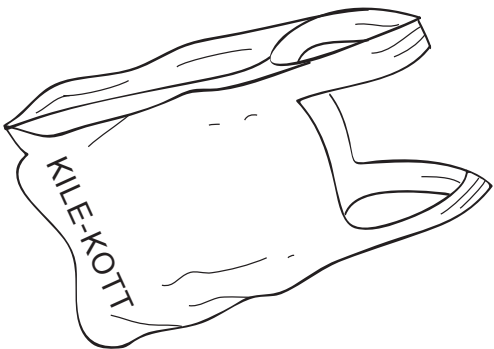
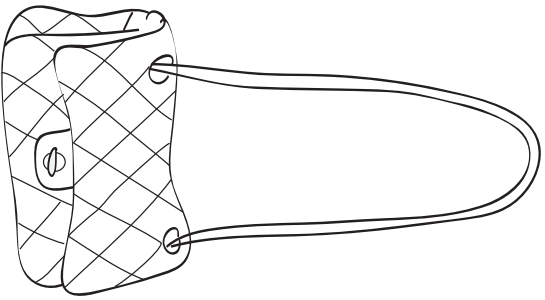
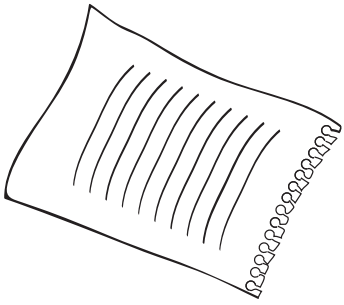
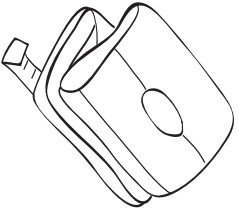

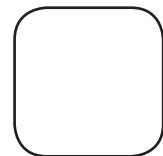
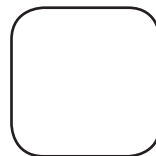
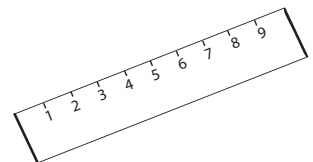
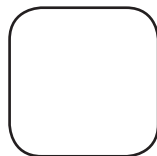
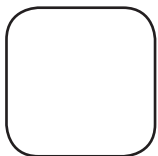
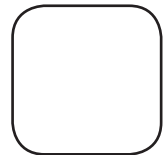
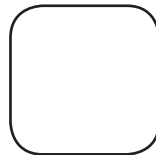
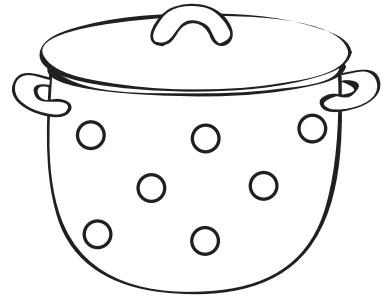
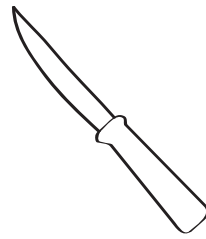
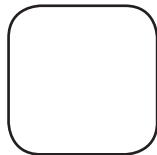
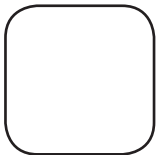
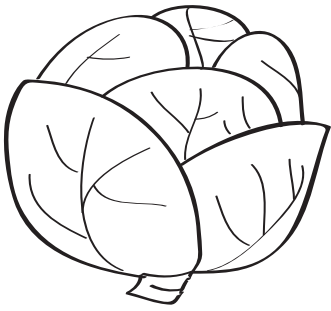



□ 

 □

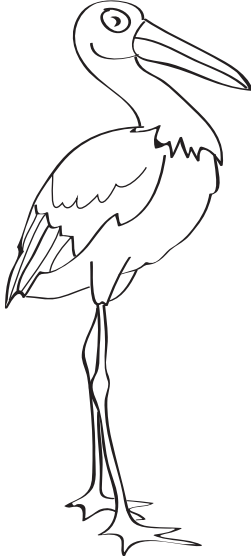
□ 

 □

□ 

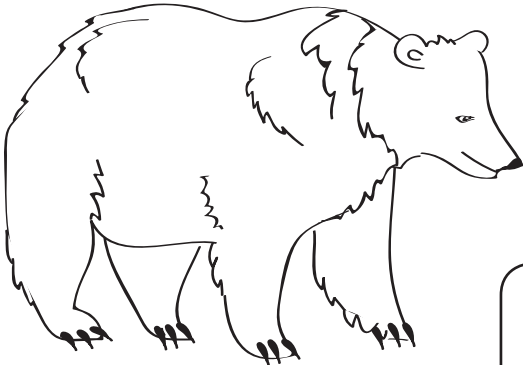
 □

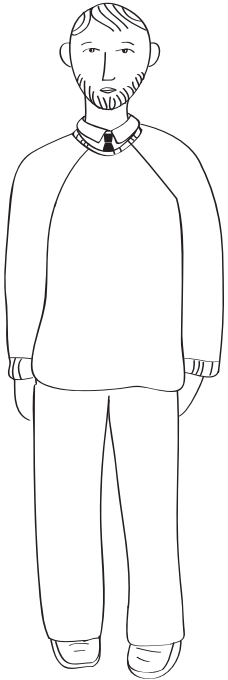

 □ □

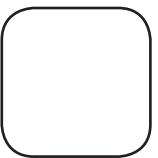
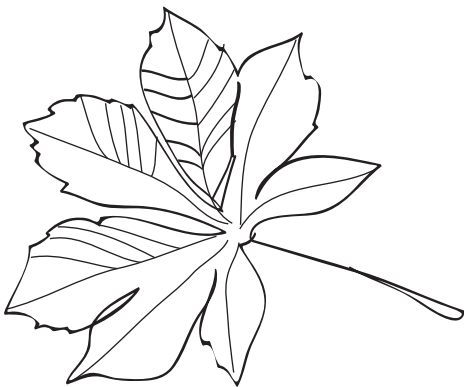
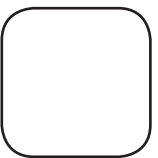
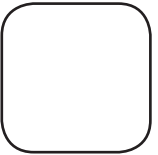
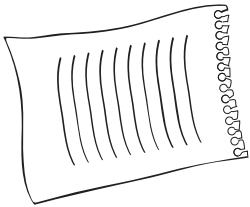
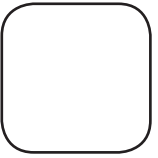
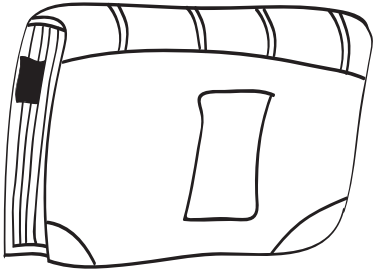
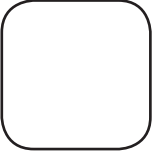
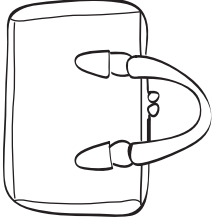
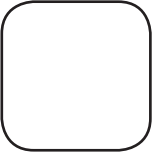
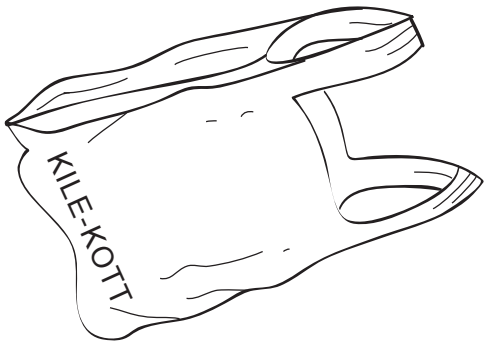

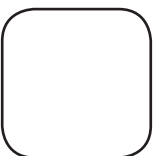
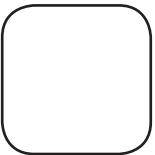
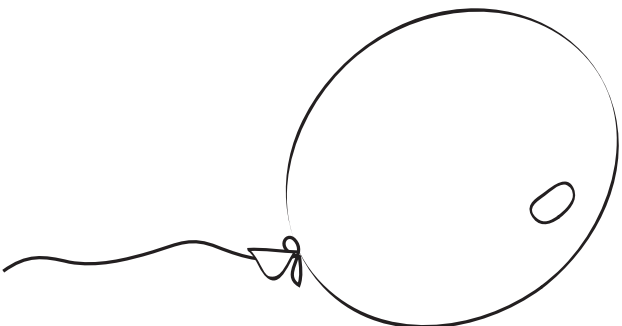
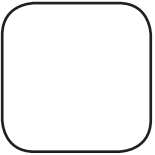
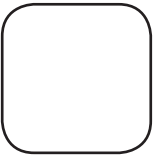
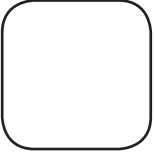
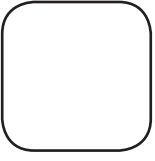
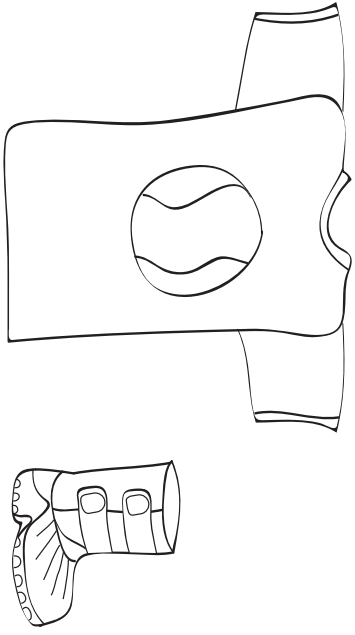



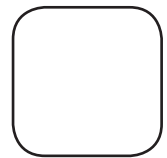
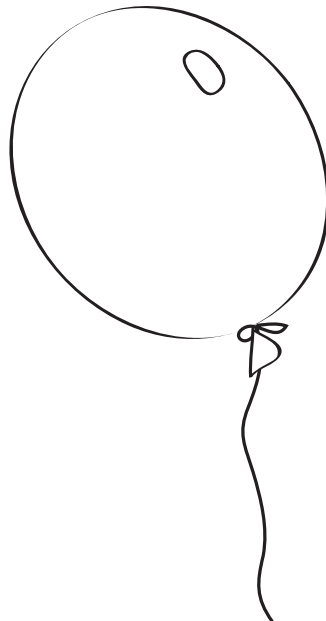
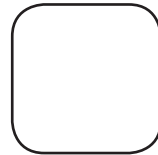
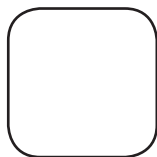
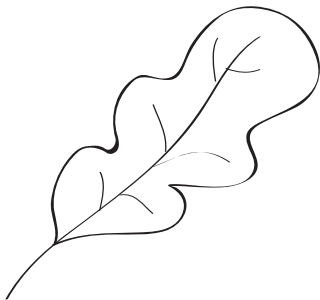
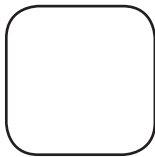
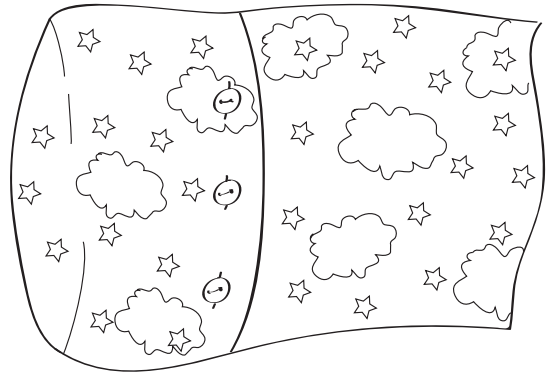
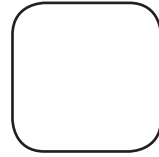
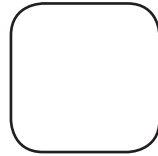
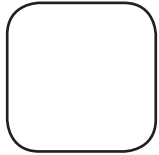
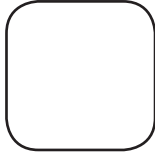
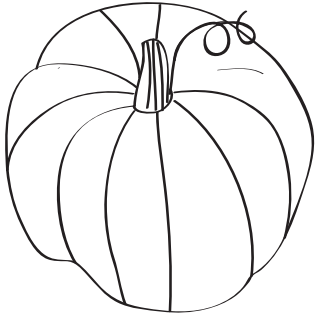

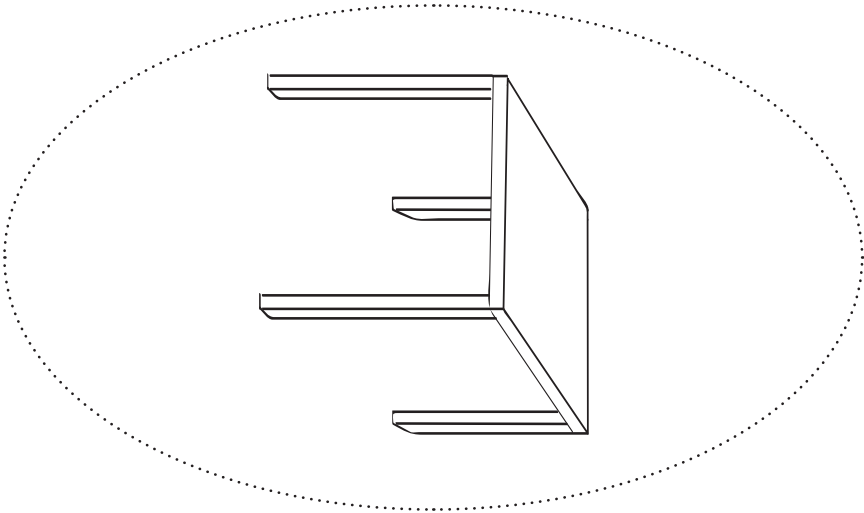
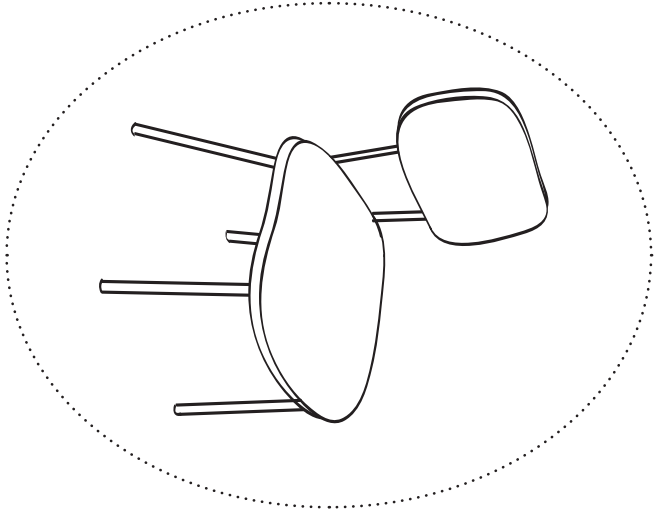
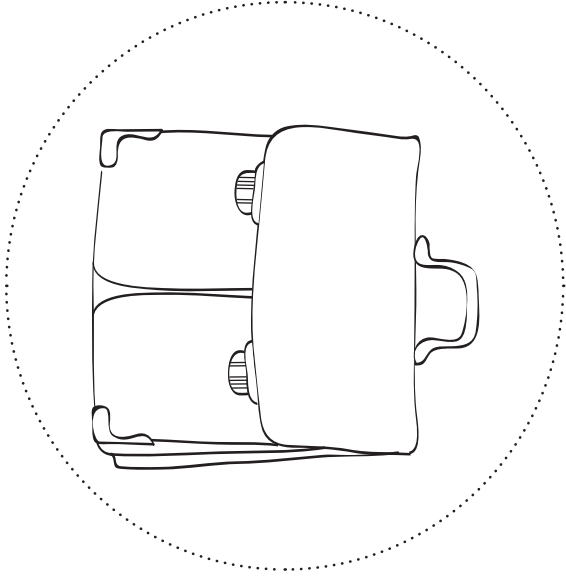
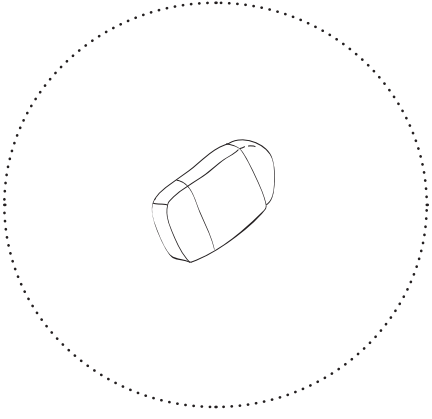

**KAAL**

**8a**

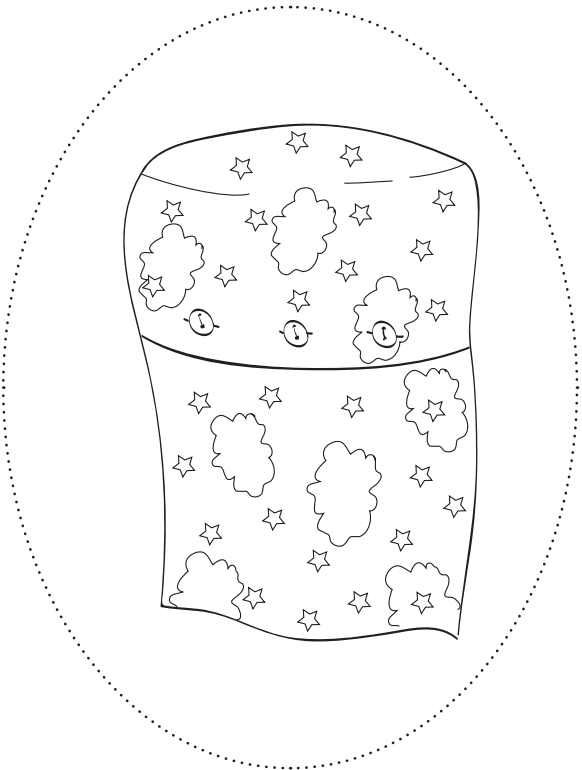
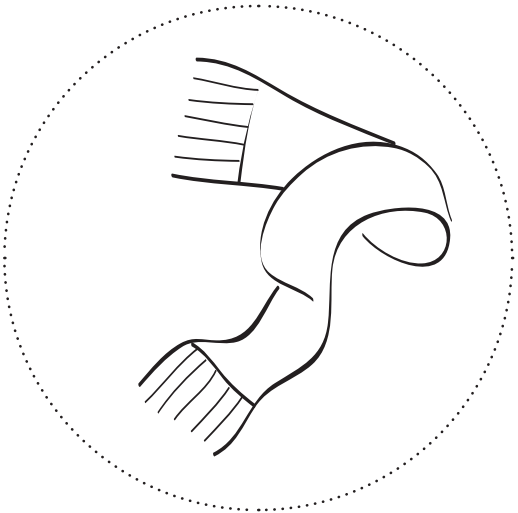
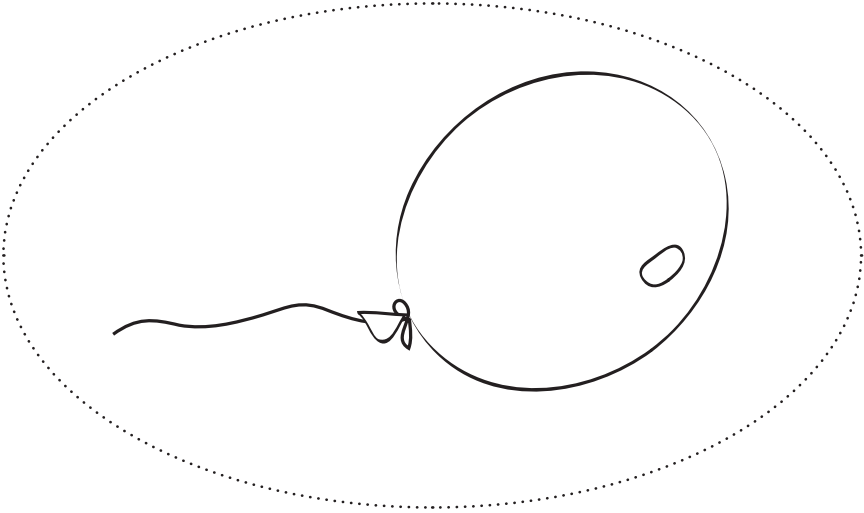
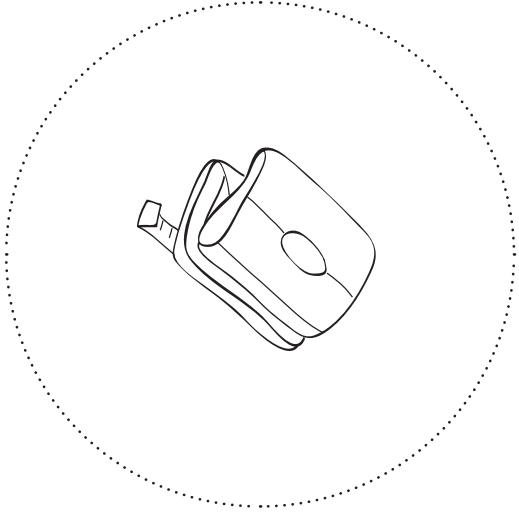
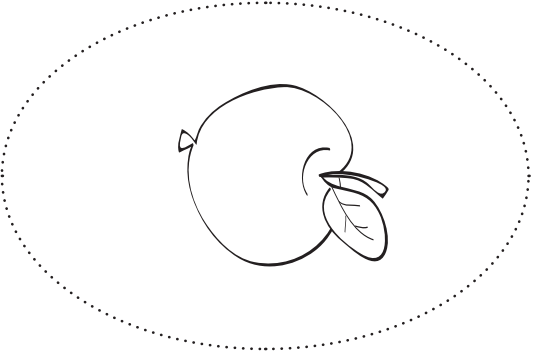

**KAAL**

**9a**

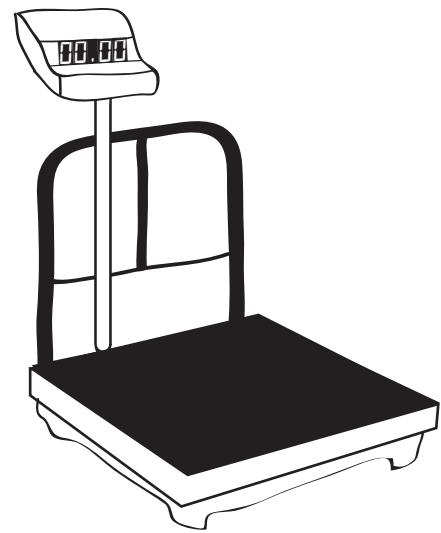
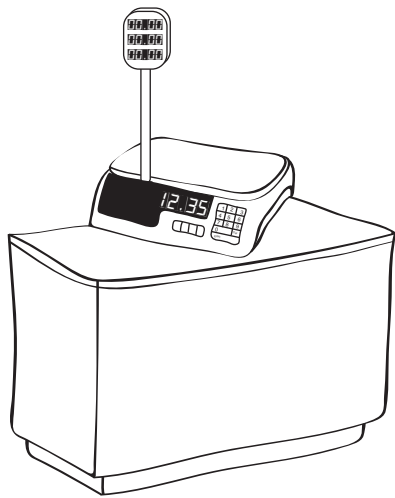
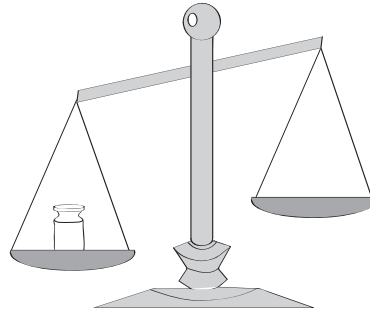
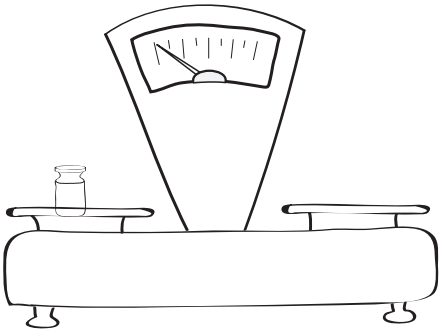

KAALU-POMM

KAALU-POMMIDEGA KAALUD

ELEKTRI-LISED KAALUD

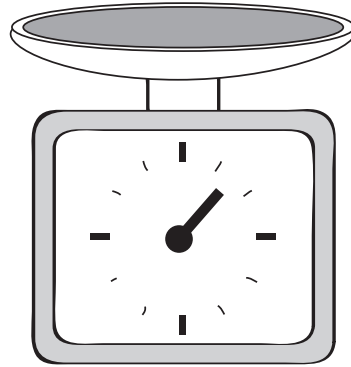
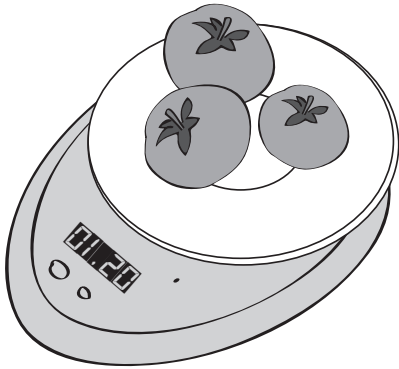

Empty rounded rectangular box for labeling the kitchen scale.

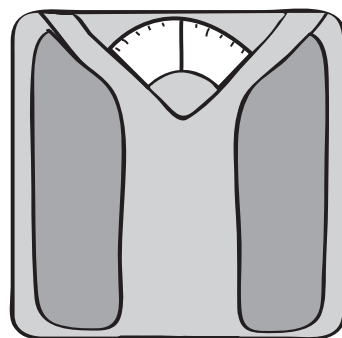
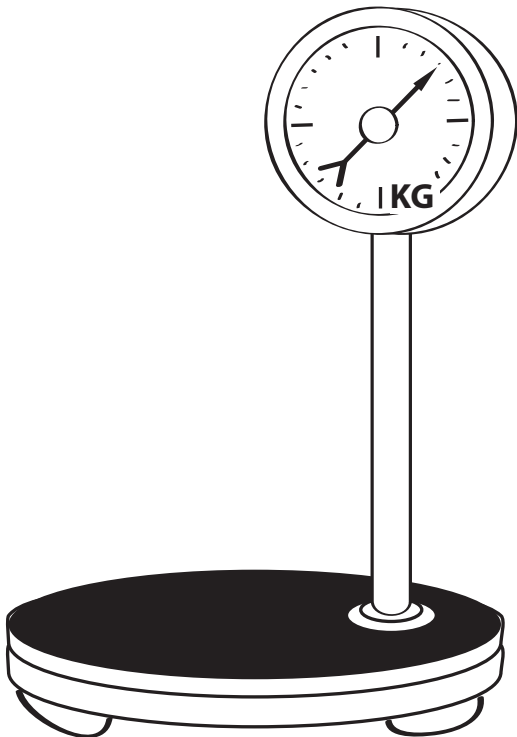

Empty rounded rectangular box for labeling the platform scale.

KÖÖGI-KAALUD

KEHA-KAALUD

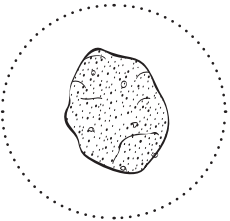
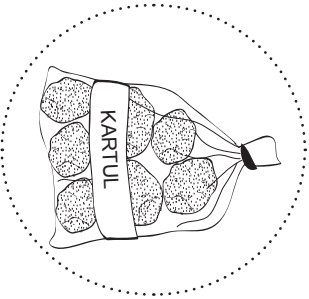
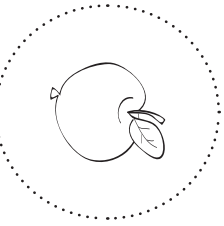
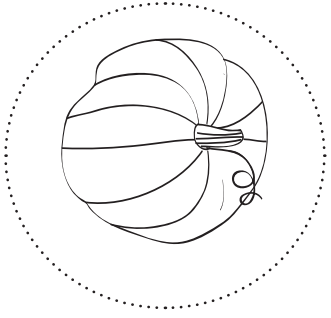
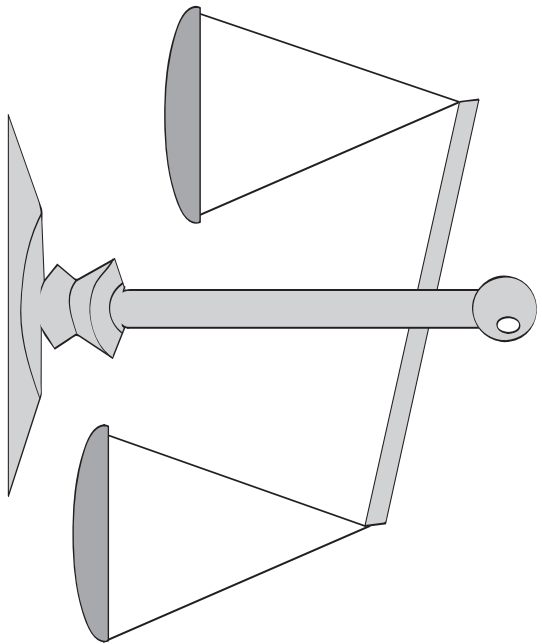
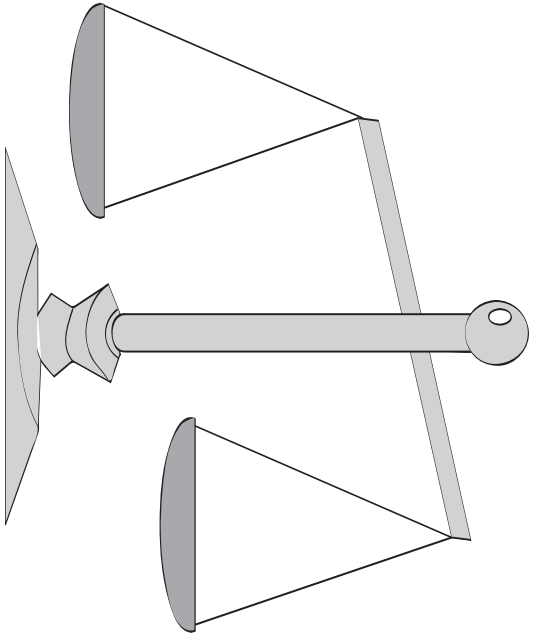



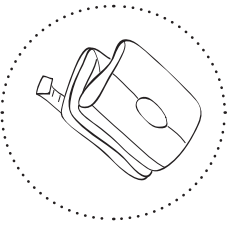
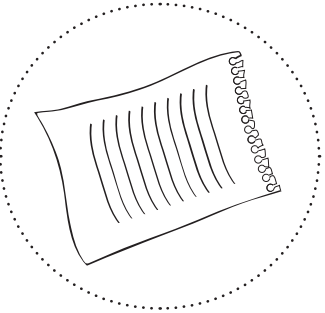
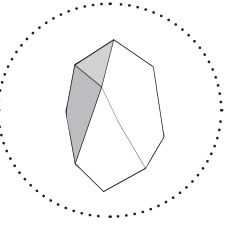
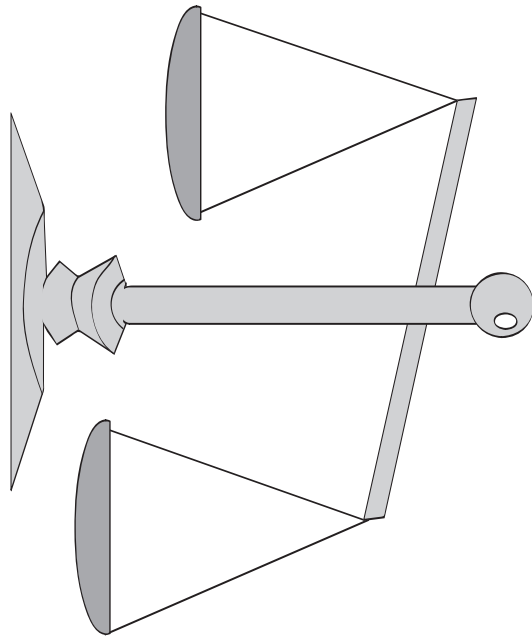
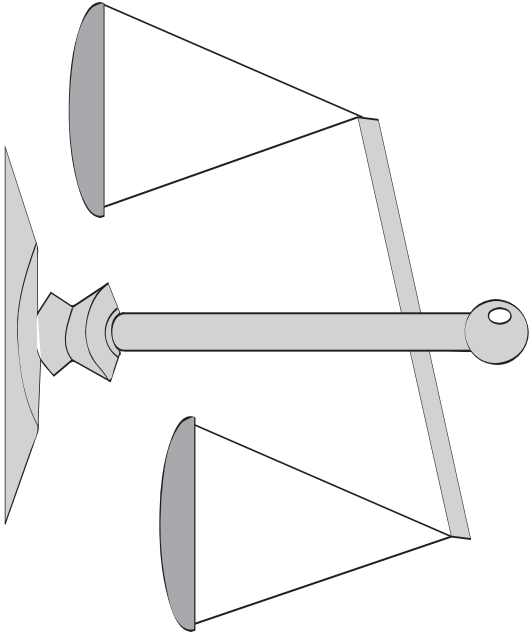

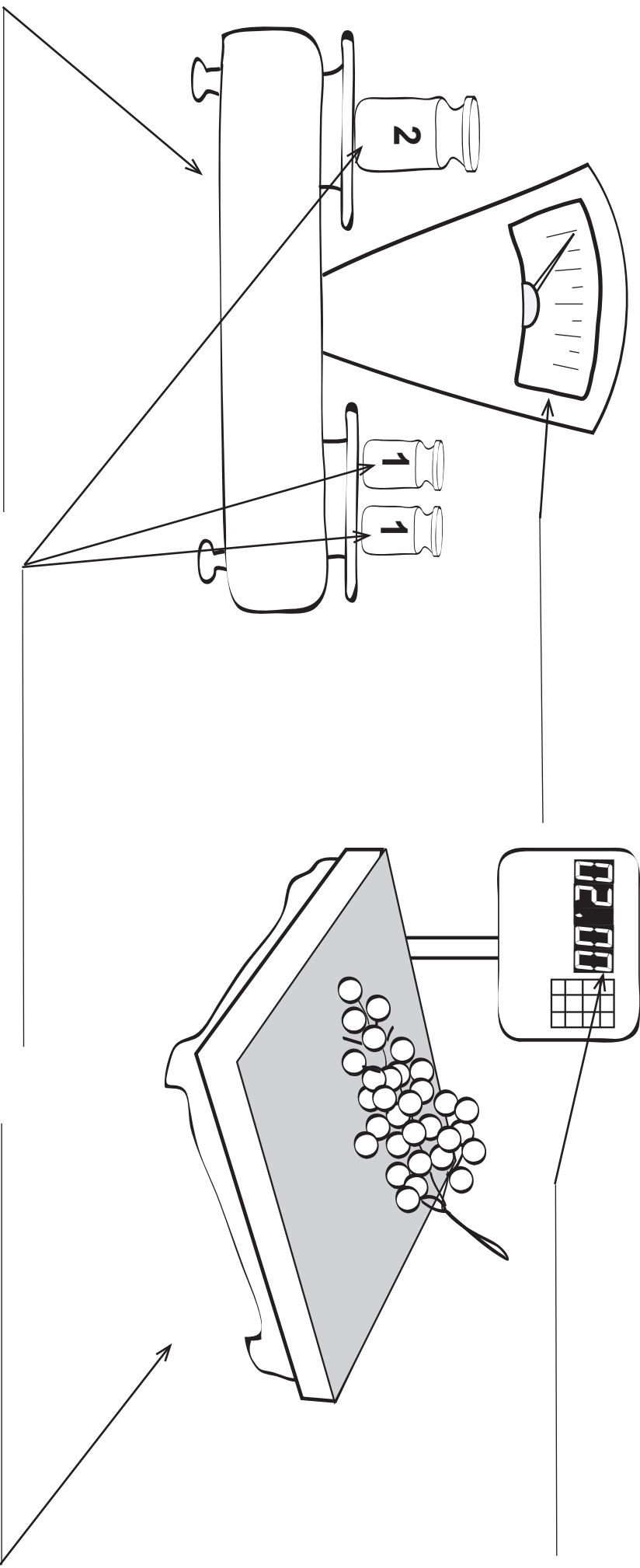

KAALU-NÄIT

KAALU-VIHT

ELEKTRON-KAAL

KAALU-VIHTIDEGA KAAL

# KAAL

15a

KILO-GRAMMI

LÜHEND ON

KG

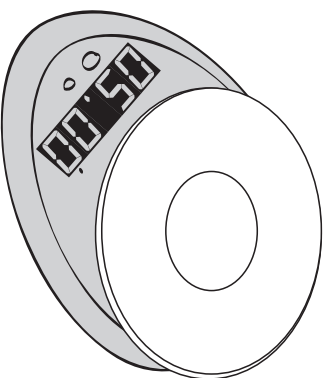

5 KG

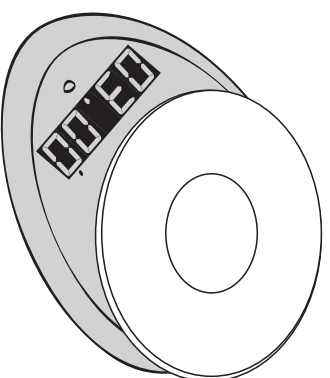

3 KG

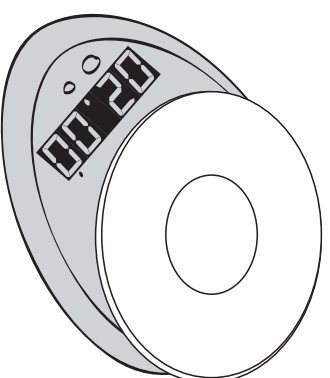

2 KG

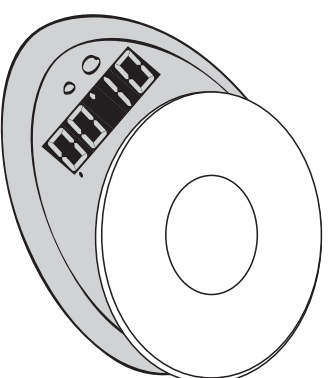

1 KG

2 KG



5 KG

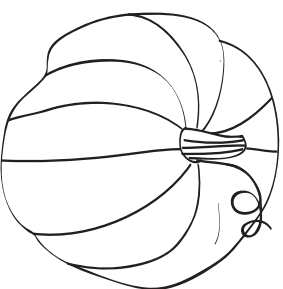

1 KG

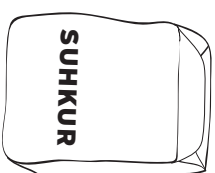

3 KG

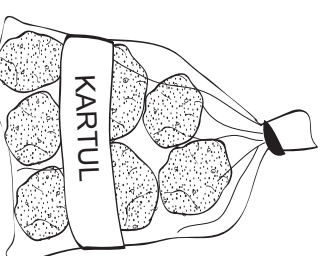

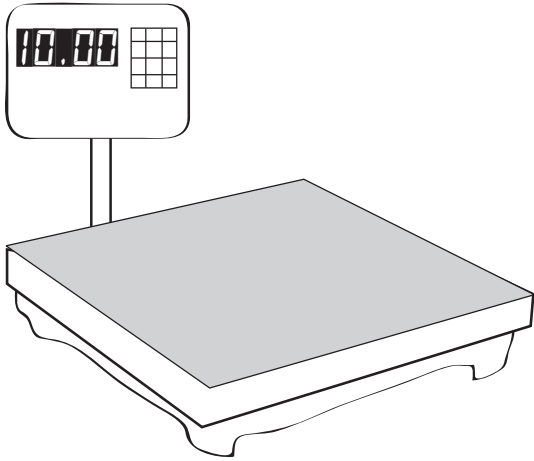

10 KG

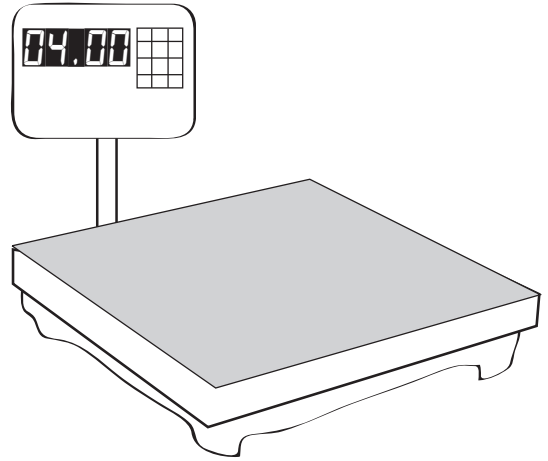

4 KG

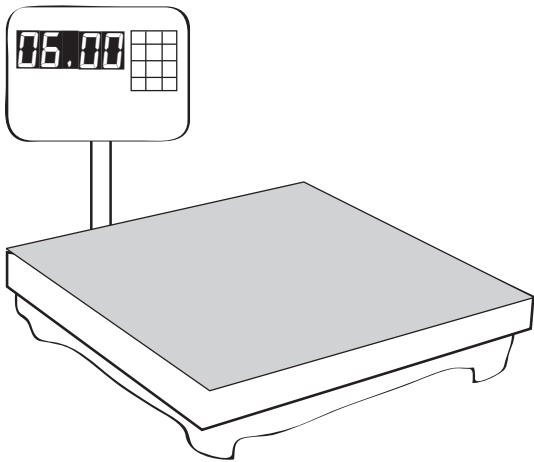



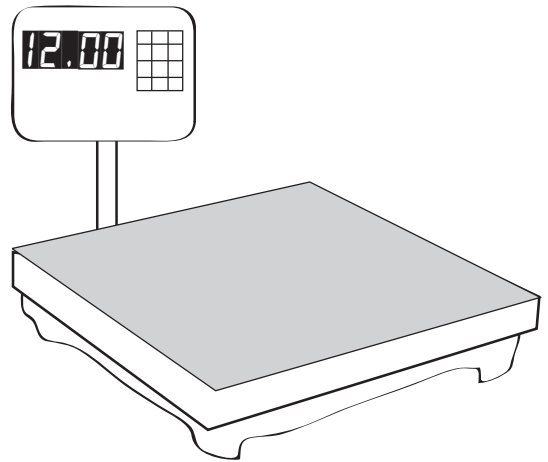







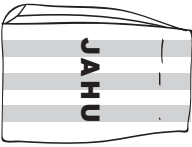

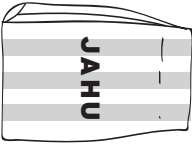

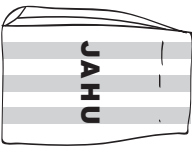
6 KG

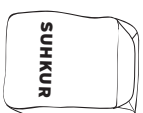

12 KG

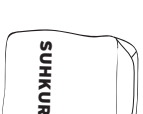
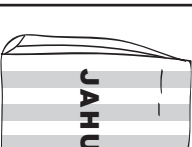
# KAAL

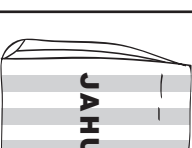
15c

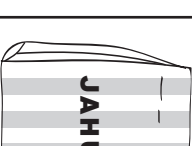
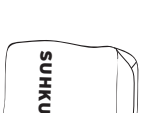
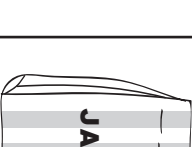
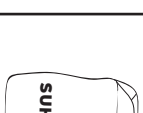

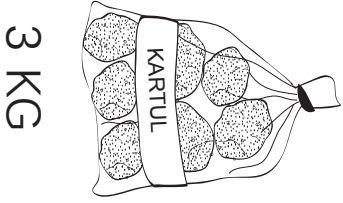
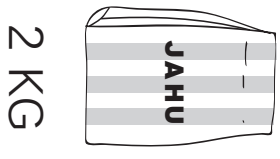
# KAAL

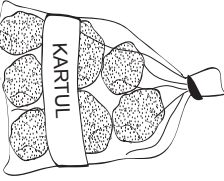
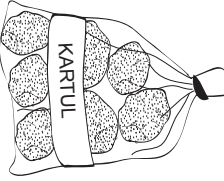
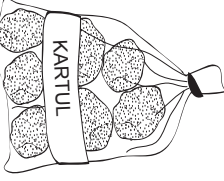
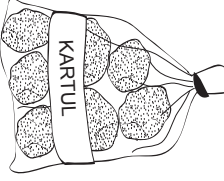
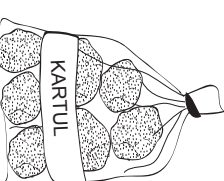
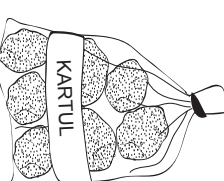
GRAMM – KERGED ASJAD

GRAMMI LÜHEND ON G

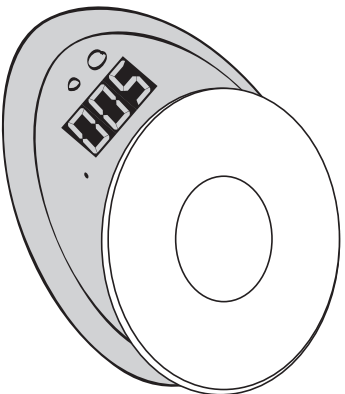

500 G

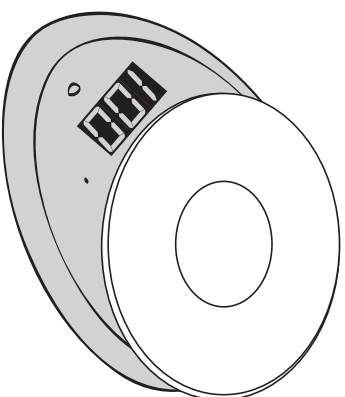

100 G

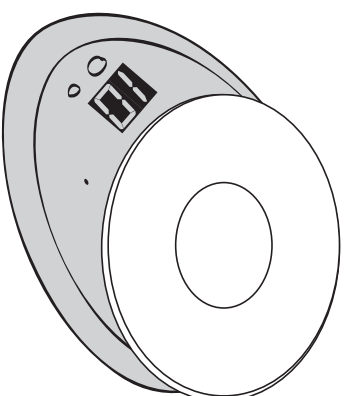

10 G

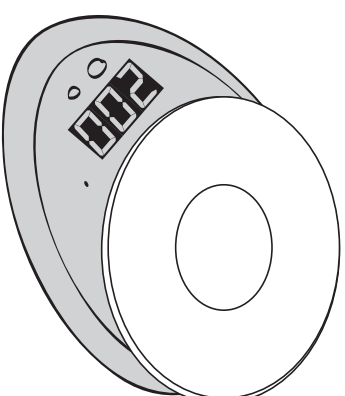

200 G



10 G

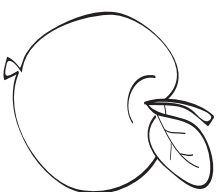

200 G



100 G

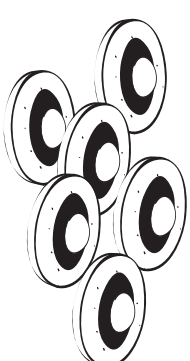

500 G

TONNI – VÄGA RASKED ASJAD

TONNI LÜHEND ON **T**

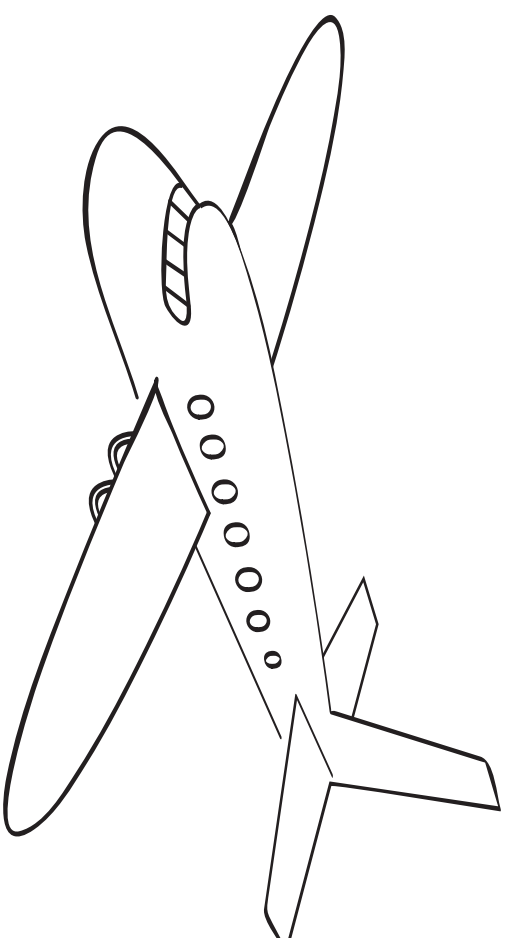
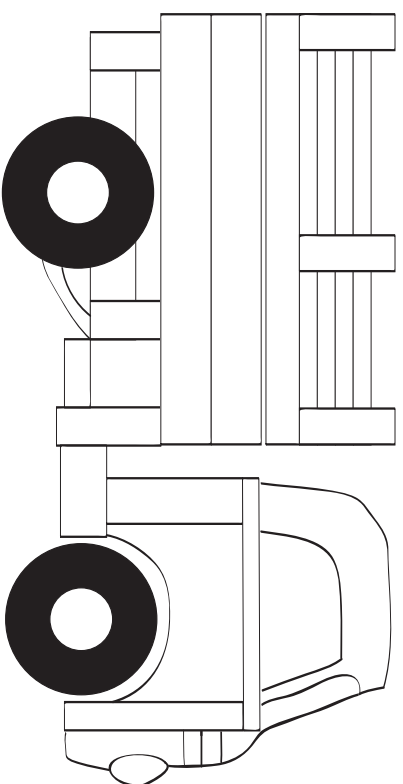
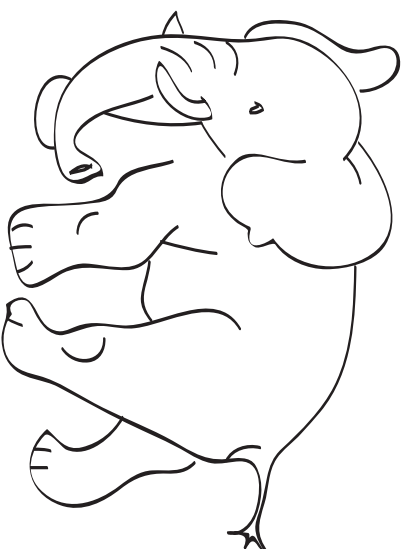
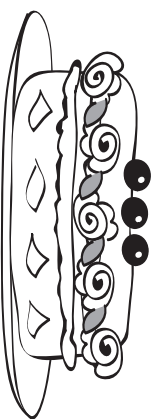

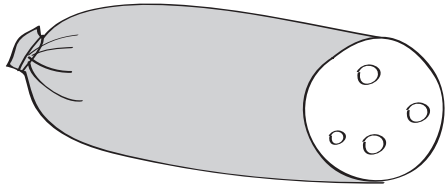

\_\_\_\_\_ GRAMMI

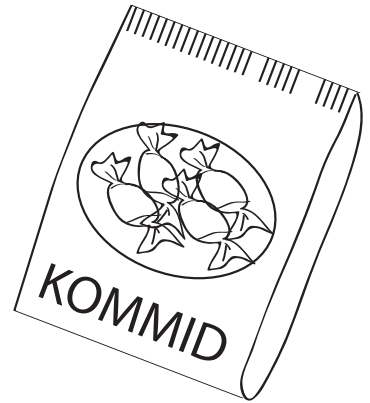

\_\_\_\_\_ GRAMMI

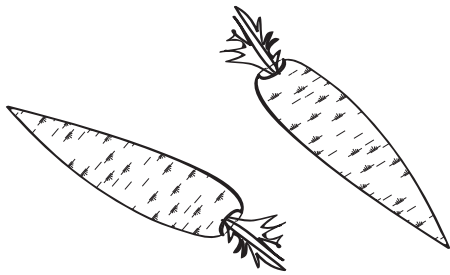

\_\_\_\_\_ GRAMMI



\_\_\_\_\_ GRAMMI

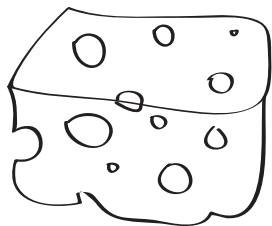

\_\_\_\_\_ GRAMMI

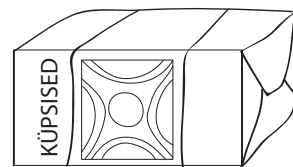

\_\_\_\_\_ GRAMMI



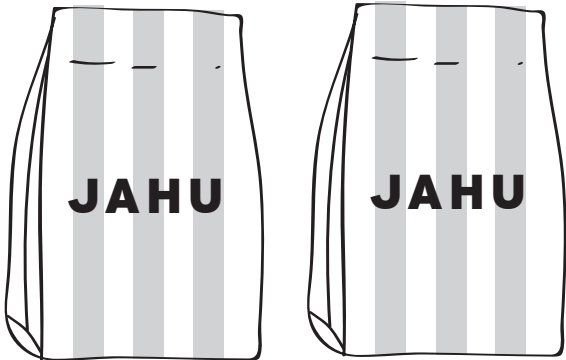

\_\_\_\_\_ KILO-GRAMMI

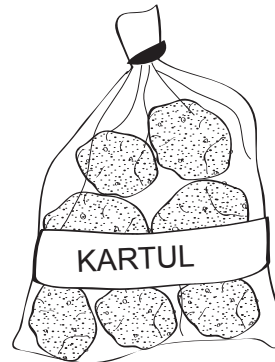

\_\_\_\_\_ KILO-GRAMMI

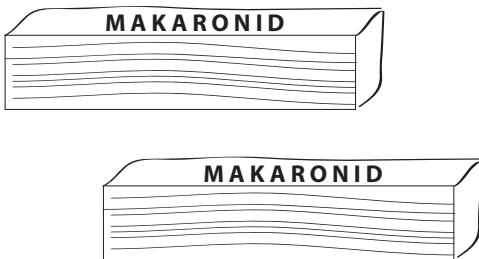

\_\_\_\_\_ KILO-GRAMMI



\_\_\_\_\_ KILO-GRAMMI



\_\_\_\_\_ KILO-GRAMMI

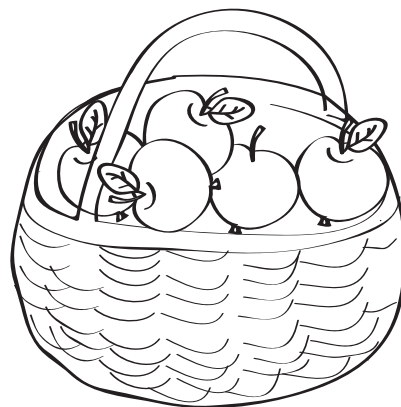

\_\_\_\_\_ KILO-GRAMMI

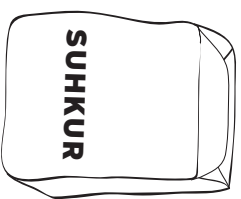

GRAMMI

KILO-GRAMMI

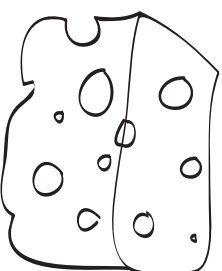

GRAMMI

KILO-GRAMMI



GRAMMI

KILO-GRAMMI

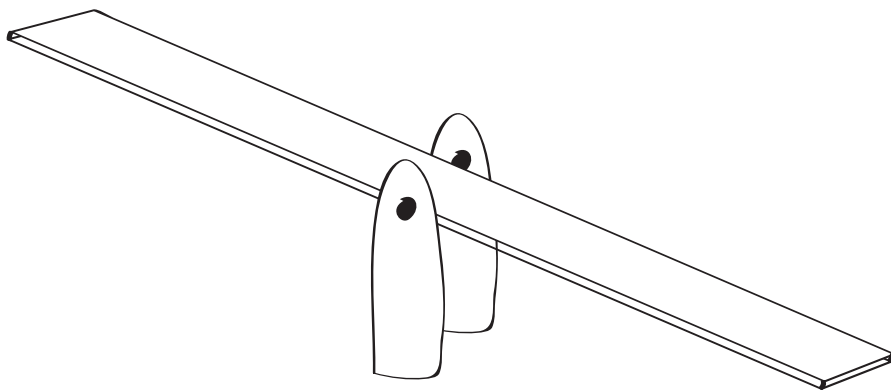

KERGEM

RASKEM

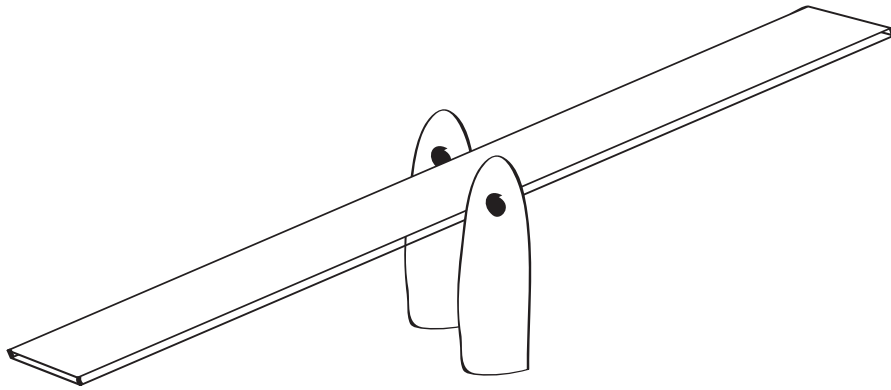

KERGEM

RASKEM

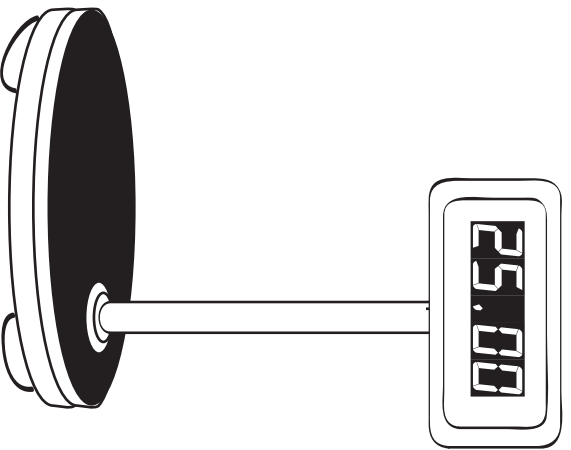

25 KG

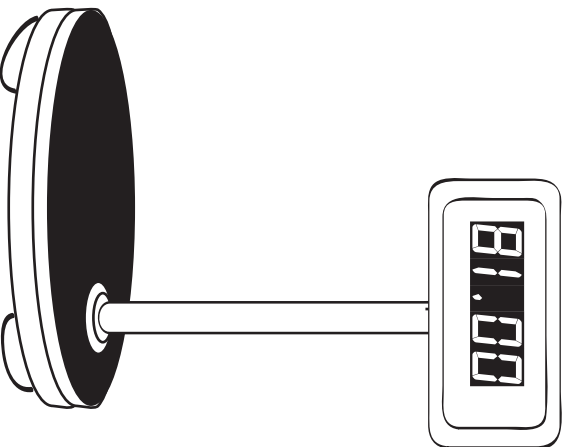

81 KG

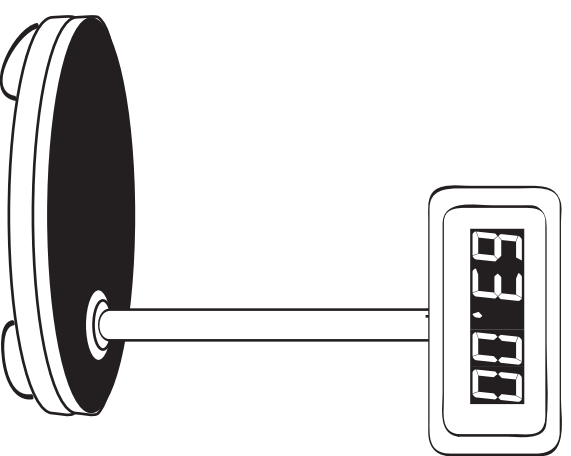

63 KG

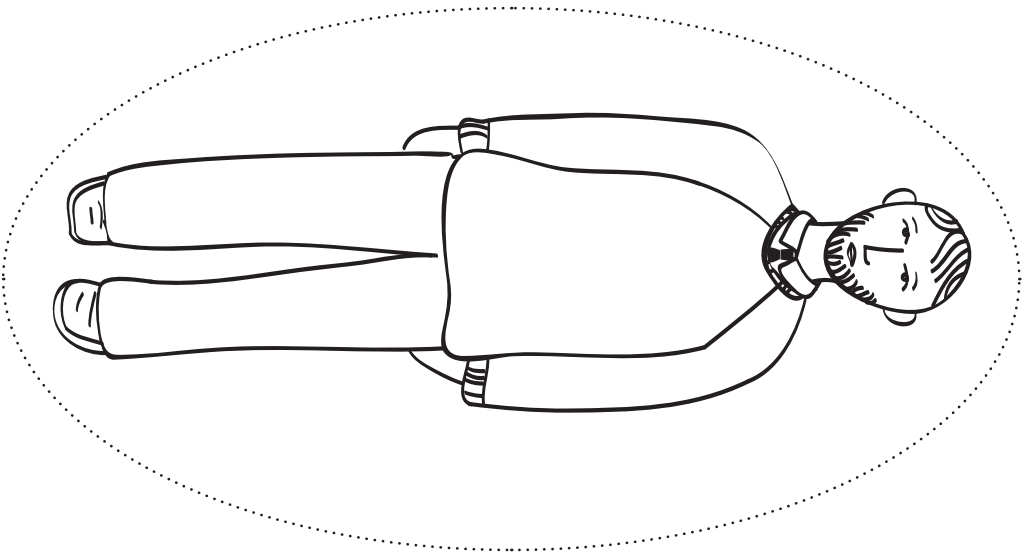

81 KG

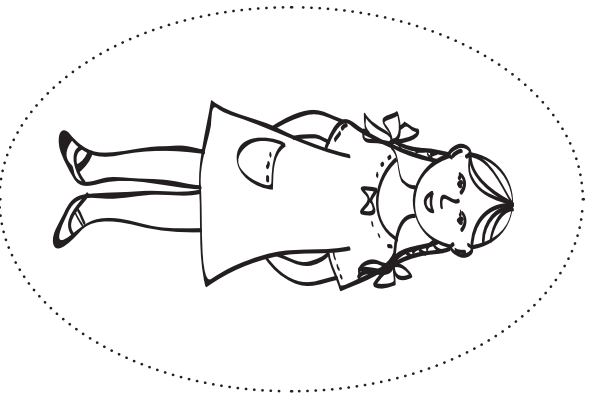

25 KG

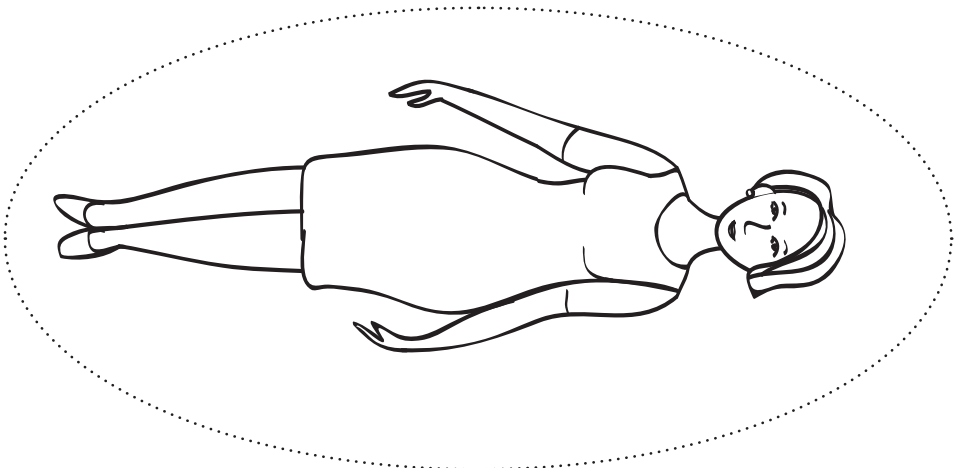

63 KG



47 KG

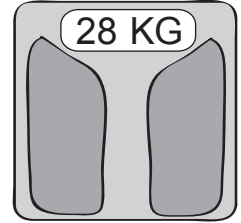

11 KG

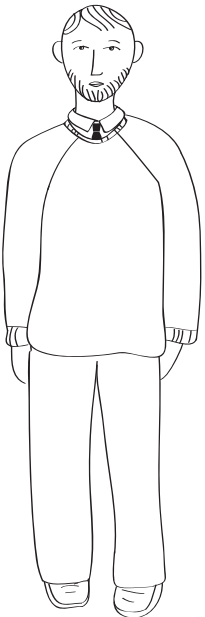
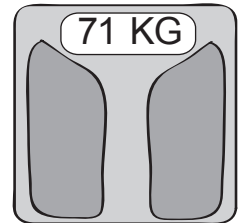

71 KG

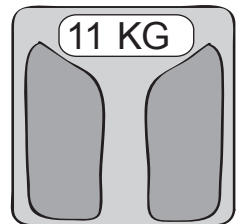

28 KG

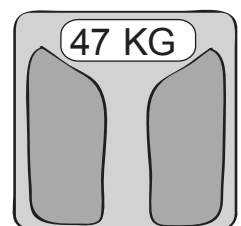

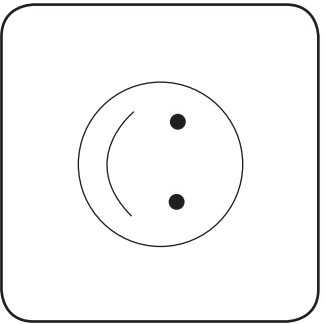

\_\_\_\_\_ KG

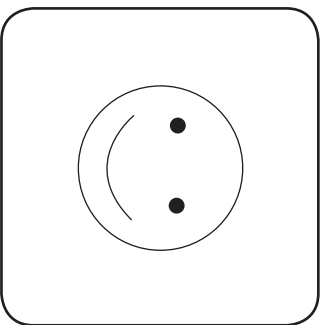

\_\_\_\_\_ KG

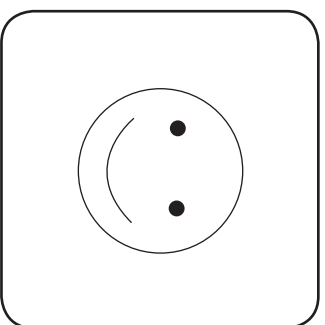

\_\_\_\_\_ KG

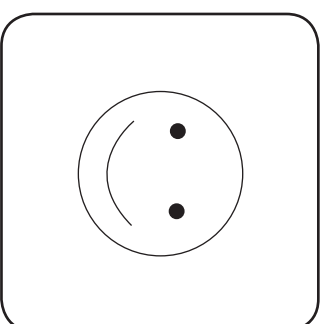

\_\_\_\_\_ KG

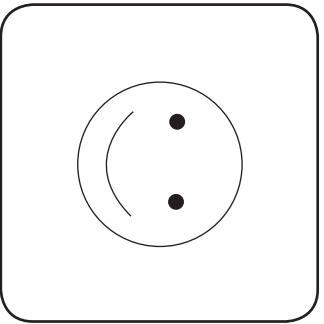

\_\_\_\_\_ KG

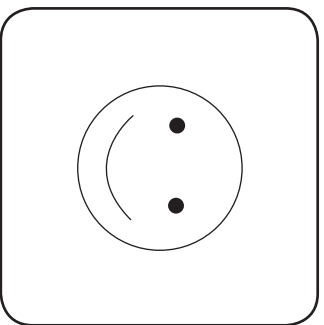

\_\_\_\_\_ KG

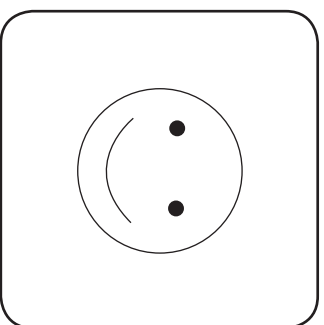

\_\_\_\_\_ KG

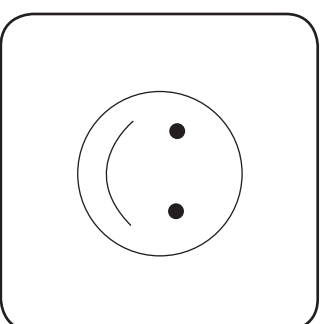

\_\_\_\_\_ KG



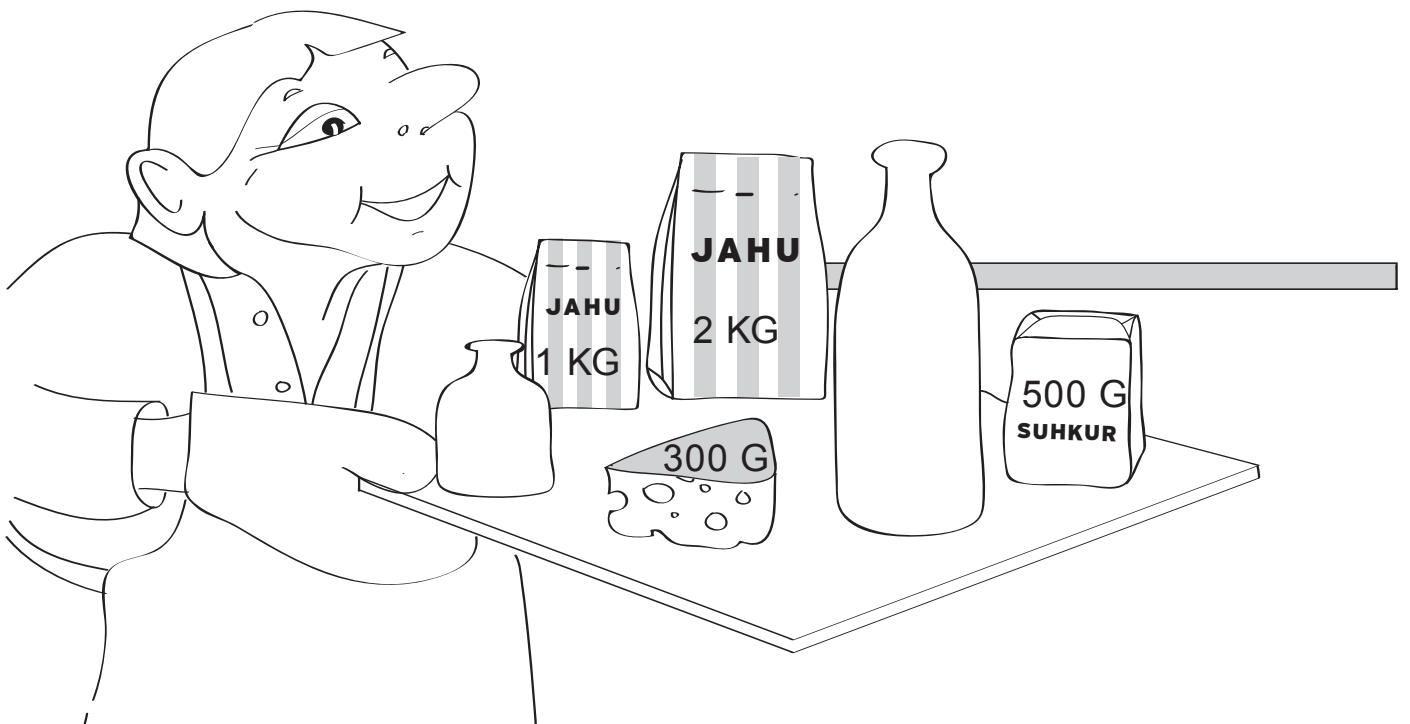
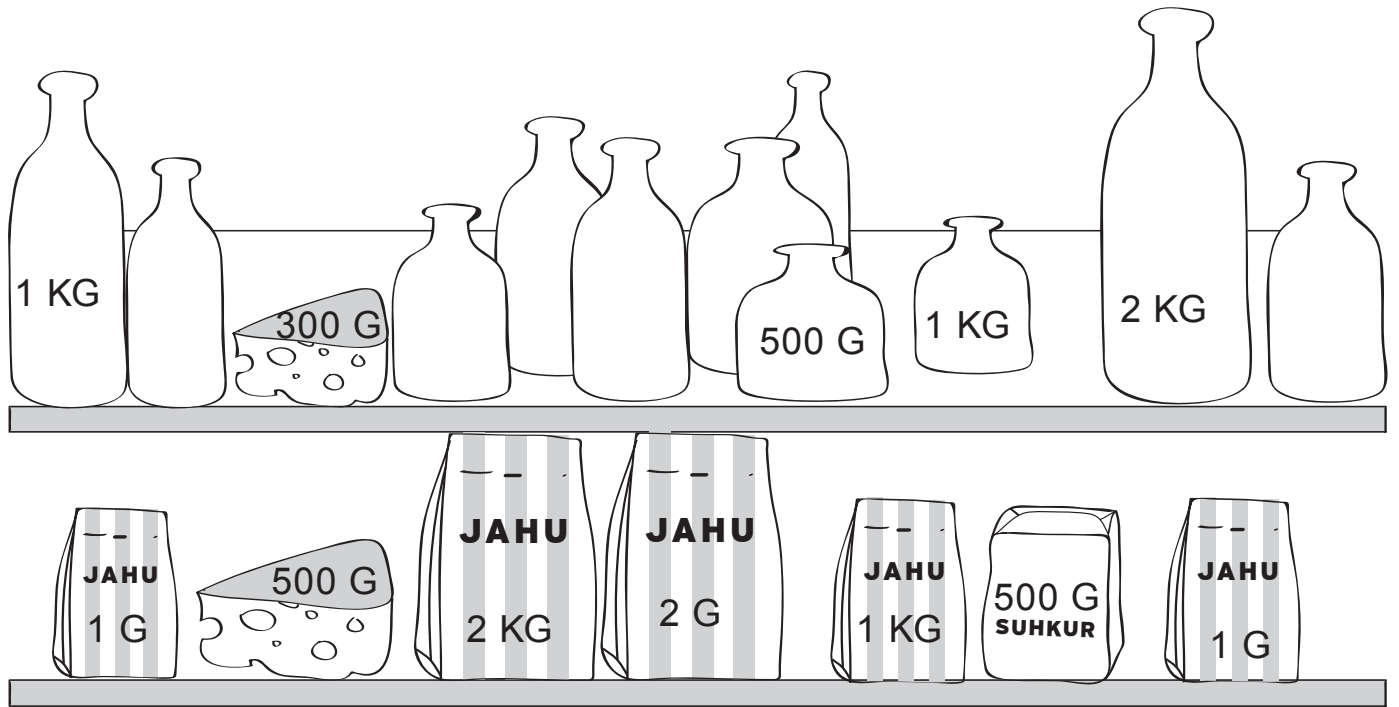

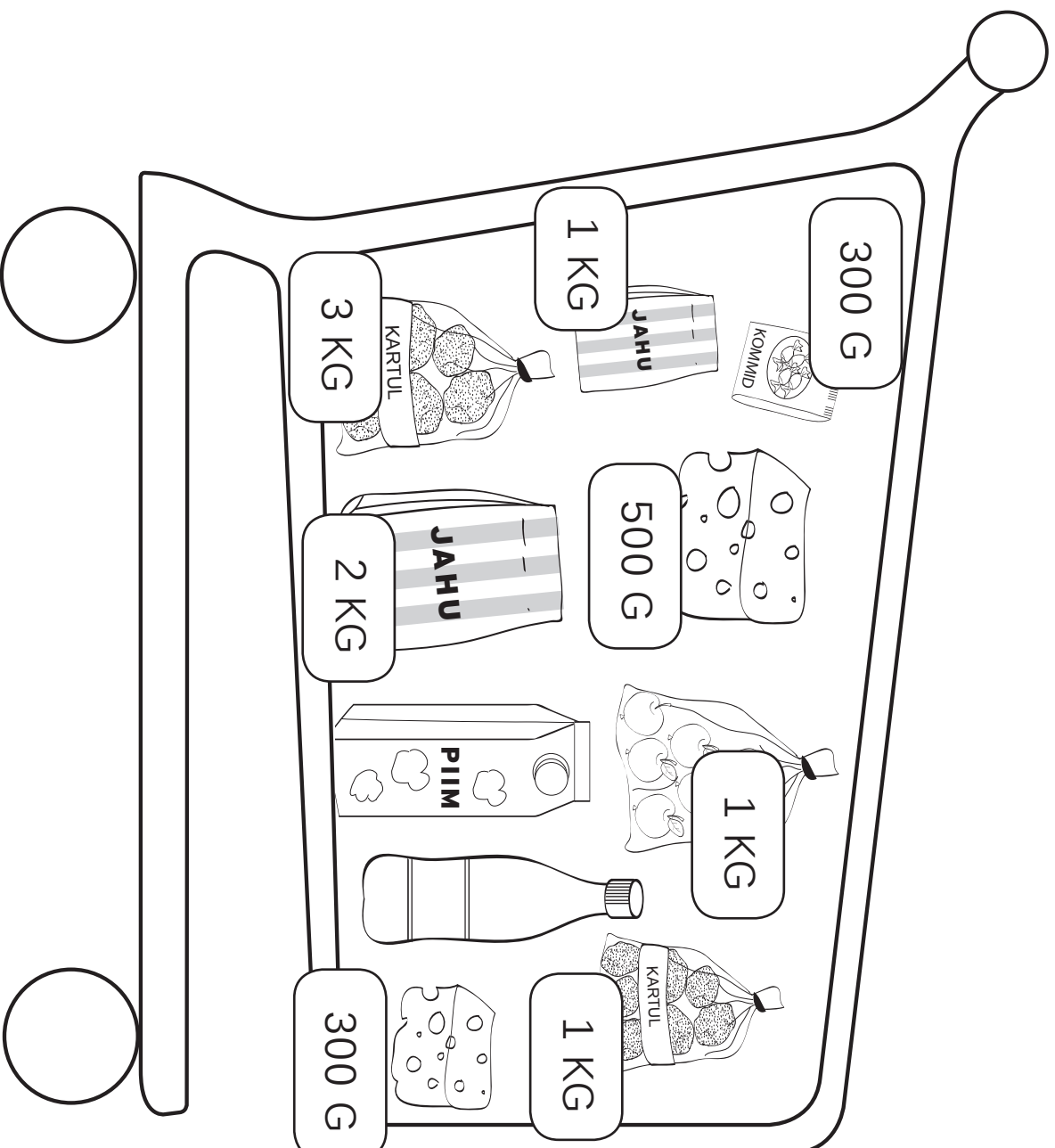

OSTU-NIMEKIRI

ÕUNAD – 1 KG

JAHU – 2 KG

KARTULID – 3 KG

KOMMID – 300 G

JUUST – 500 G

**KAERA-HELBE-KÜPSISED**

1 KG KAERA-HELBEID

500 G SUHKRUT

200 G VÕID

6 MUNA

100 G JAHU

**VALMISTAMINE:**

VAHUSTA VÕI SUHKRUGA.

LISA ÜHE-KAUPA MUNAD.

SEGA JUURDE JAHU JA KAERA-HELBED.

ASETA TAIGEN TEE-LUSIKAGA

KÜPSETUS-PABERILE.

KÜPSETA KULD-PRUUNIKS.

**OSTU-NIMEKIRI**

---

---

---

---

---

---

---

---

KAERA-HELBEID – 1 KG

SUHKUR – 1 KG

VÕI – 200 G

JAHU – 1 KG

6 MUNA



200 G



1 KG

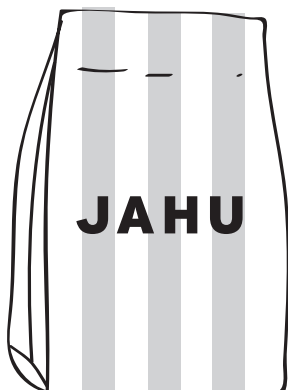

2 KG



3 KG

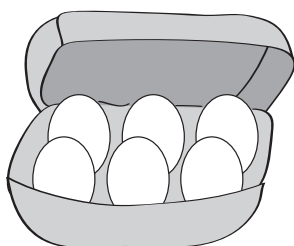

6 MUNA



1 KG



# RAHA

1a

1 SENT		
2 SENTI		
5 SENTI		
10 SENTI		
20 SENTI		
50 SENTI		

# RAHA



# RAHA













2a



# RAHA

2b

						
						



# RAHA

PILLE

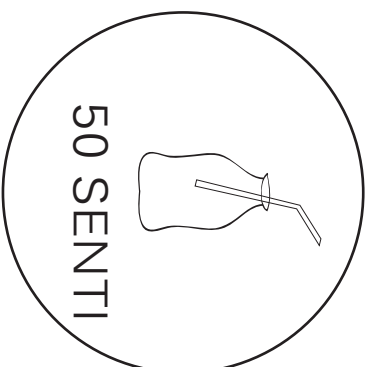
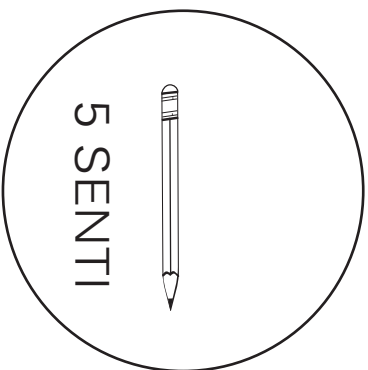
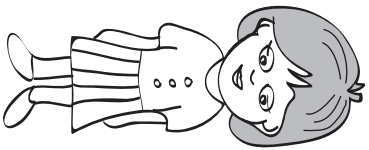

SIIM



MARI

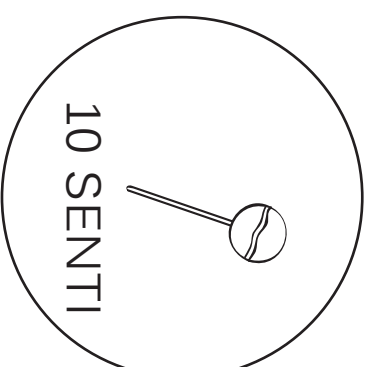
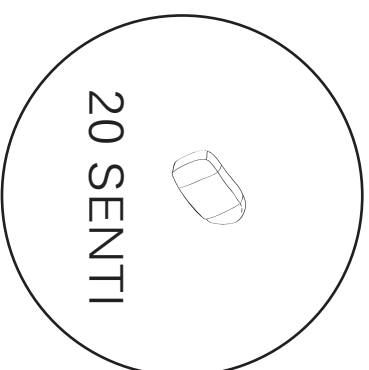
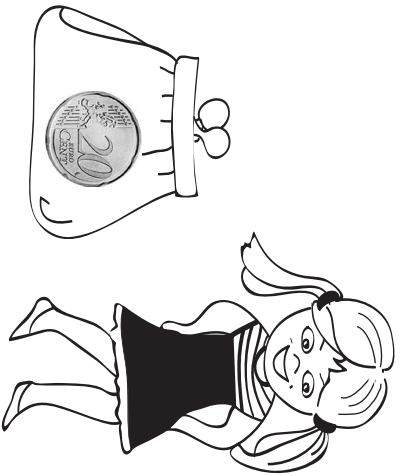

TIINA

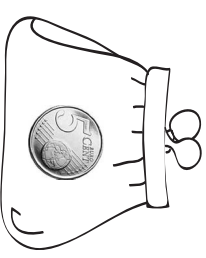

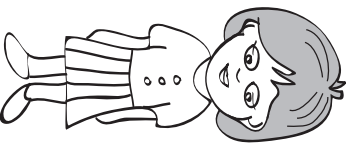

PILLEL ON \_\_\_\_\_ SENTI.

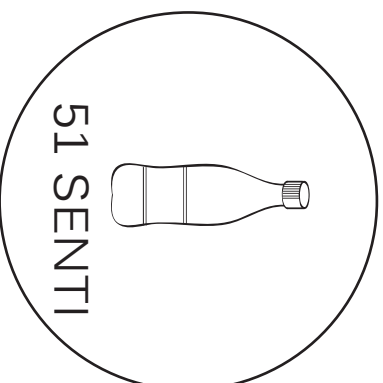

SIIMUL ON \_\_\_\_\_ SENTI.



MARIL ON \_\_\_\_\_ SENTI.

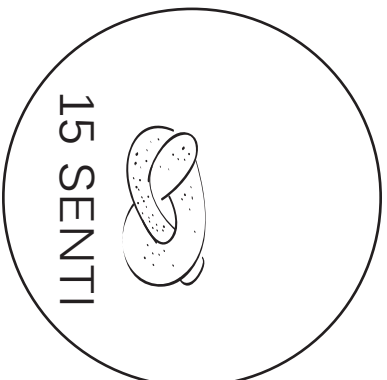
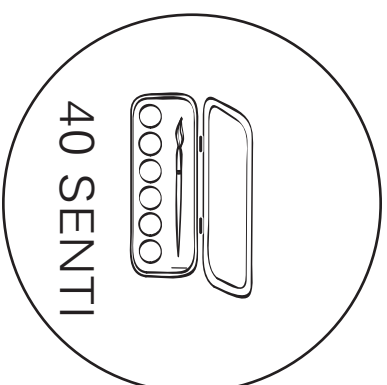

TIINAL ON \_\_\_\_\_ SENTI.



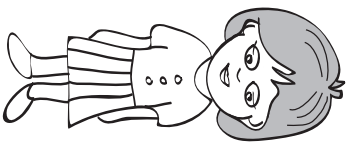

PILLEL ON \_\_\_\_\_ SENTI.

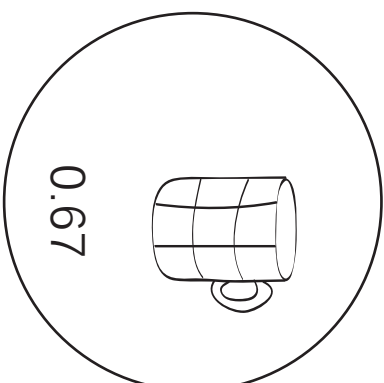
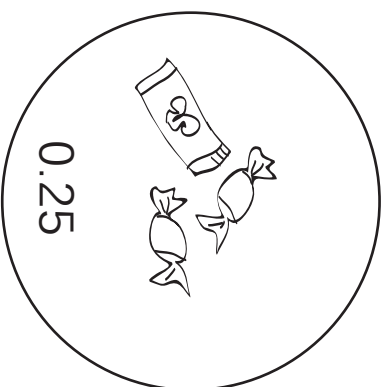

SIIMUL ON \_\_\_\_\_ SENTI.



MARIL ON \_\_\_\_\_ SENTI.

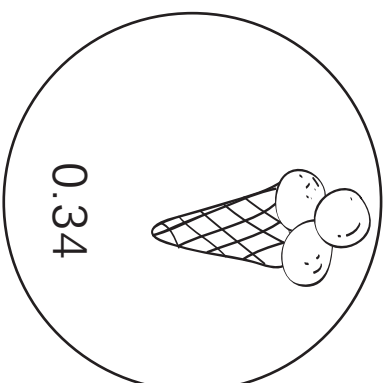
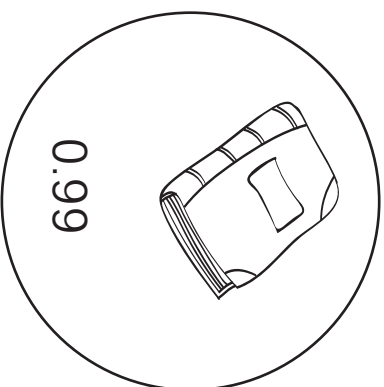

TIINAL ON \_\_\_\_\_ SENTI.

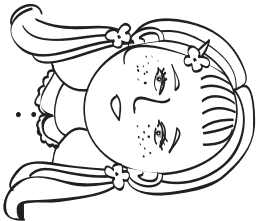
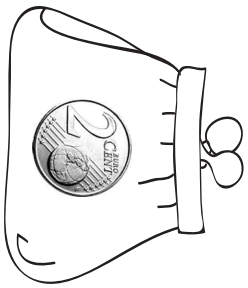

TIINAL ON \_\_\_\_\_ SENTI.

TAAVIL ON \_\_\_\_\_ EURO.

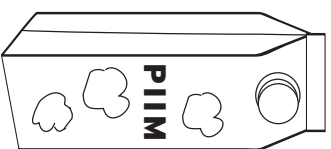
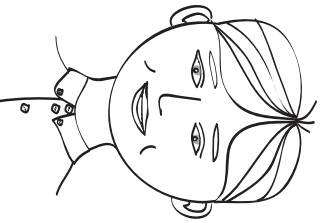

50 SENTI

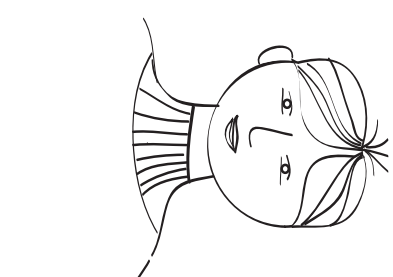

JUSSIL ON \_\_\_\_\_ SENTI.

KATIL ON \_\_\_\_\_ SENTI.



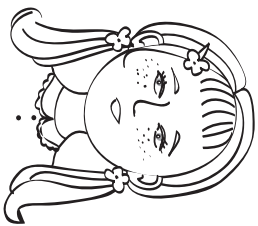
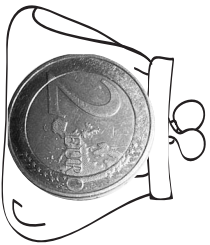

TIINAL ON \_\_\_ EUROT.

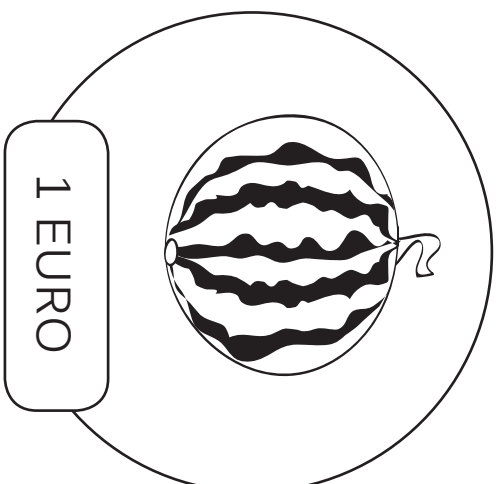

TAAVIL ON \_\_\_ SENTI.

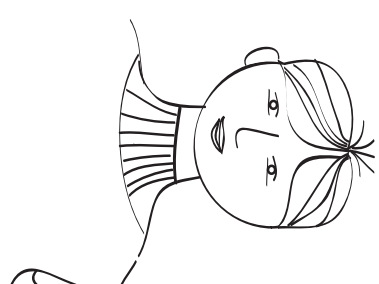

JUSSIL ON \_\_\_ SENTI.

KATIL ON \_\_\_ EUROT.



MIINA

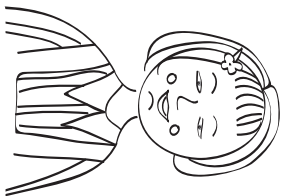

\_\_\_\_\_ EURO \_\_\_\_\_ SENTI

TANEL

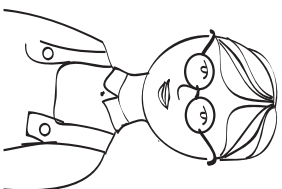

\_\_\_\_\_ EURO \_\_\_\_\_ SENTI

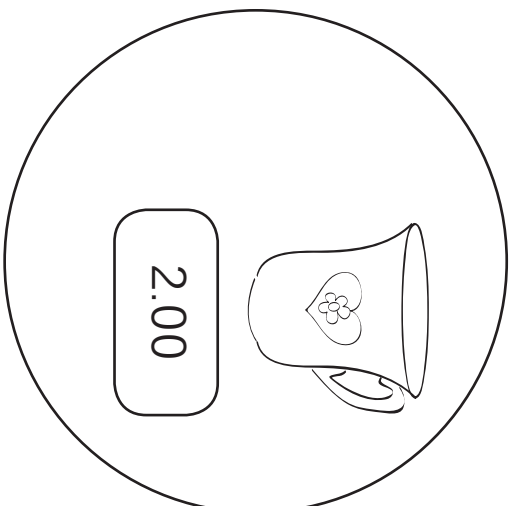

JUKU

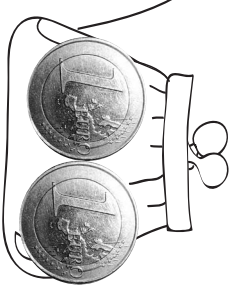

\_\_\_\_\_ EURO \_\_\_\_\_ SENTI

MEELI

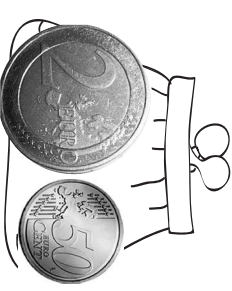

\_\_\_\_\_ EURO \_\_\_\_\_ SENTI

# RAHA

5a

TIINAL ON \_\_\_\_\_ EUROOT.

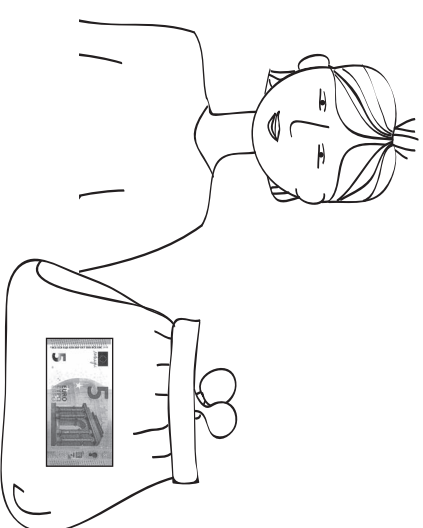
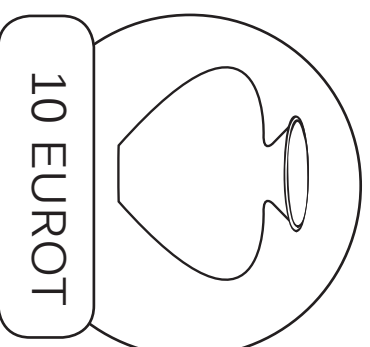
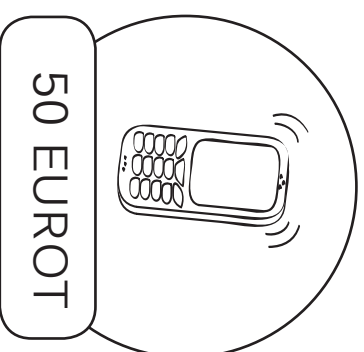
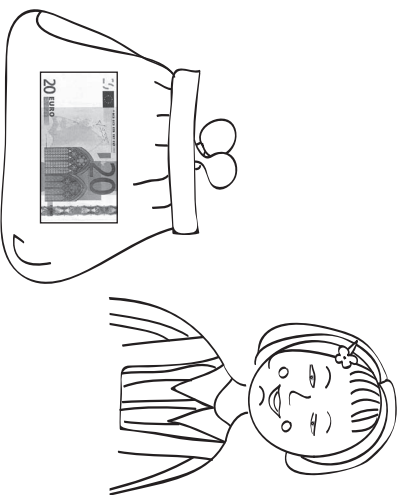

JUSSIL ON \_\_\_\_\_ EUROOT.

TAAVIL ON \_\_\_\_\_ EUROOT.

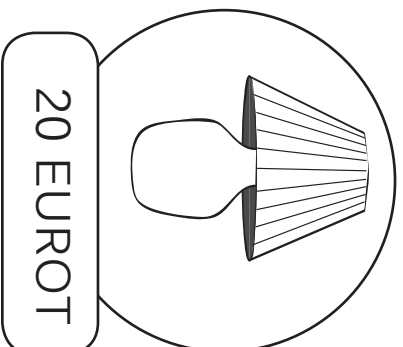
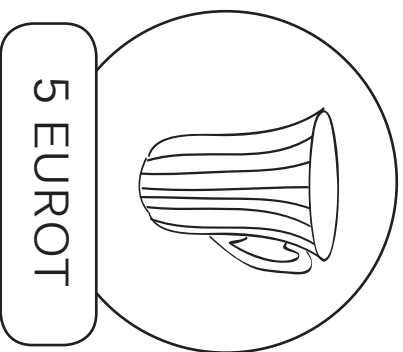
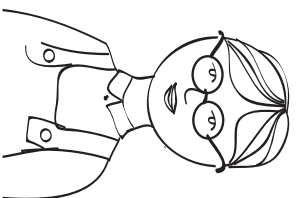
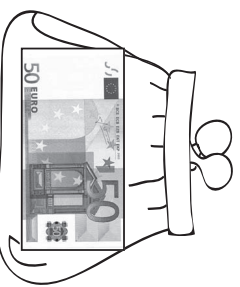

MARIL ON \_\_\_\_\_ EUROOT.

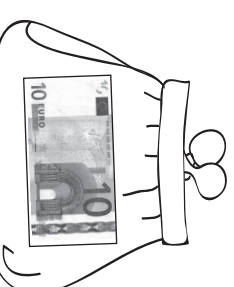

# RAHA

5b

TIINA PEREL ON \_\_\_\_\_ EURROT.

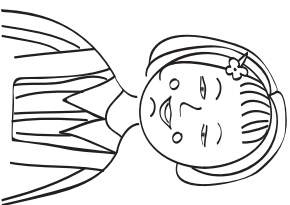
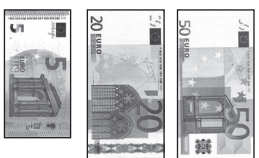

JUSSI PEREL ON \_\_\_\_\_ EURROT.

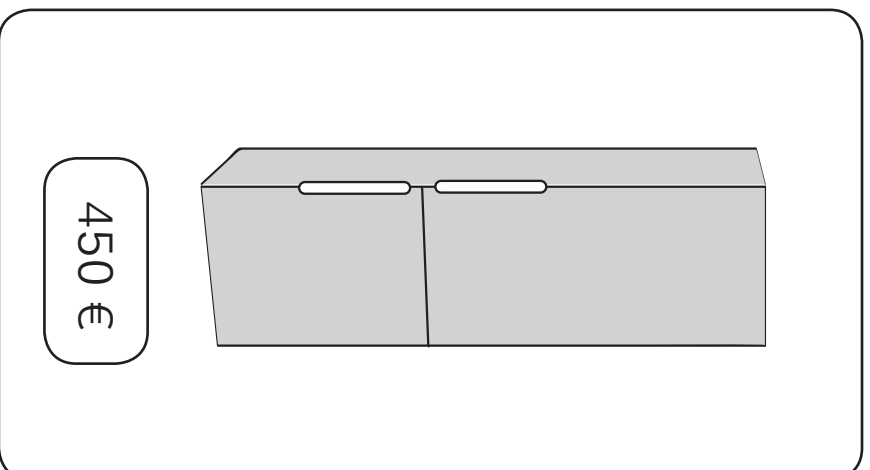
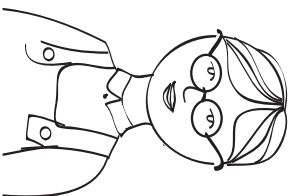
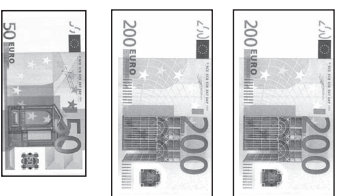
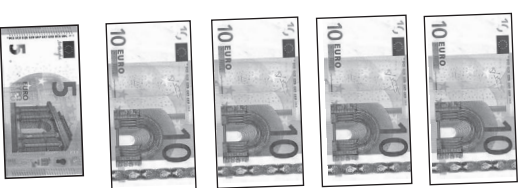

TAAVI PEREL ON \_\_\_\_\_ EURROT.



MARI PEREL ON \_\_\_\_\_ EURROT.



# RAHA

5c





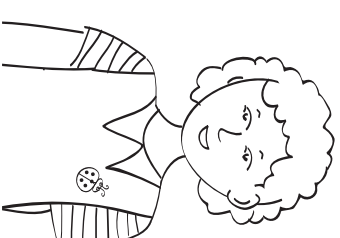
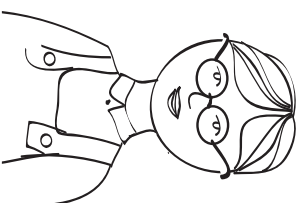
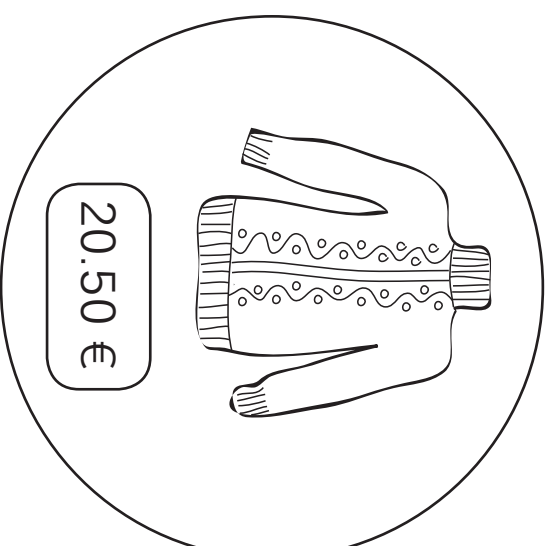
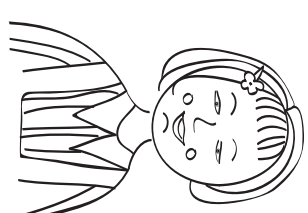

TIIDL ON \_\_\_\_\_ EUROT JA \_\_\_\_\_ SENTI.

KAIEL ON \_\_\_\_\_ EUROT JA \_\_\_\_\_ SENTI.

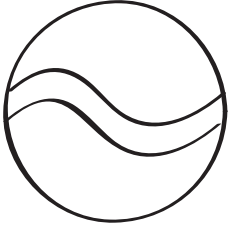
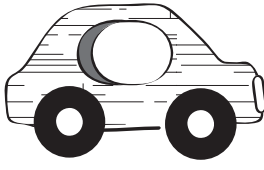
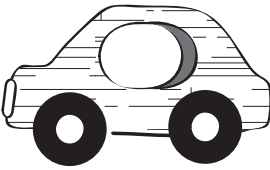

TAAVIL ON \_\_\_\_\_ EUROT JA \_\_\_\_\_ SENTI.

MAIEL ON \_\_\_\_\_ EUROT JA \_\_\_\_\_ SENTI.

 5.50	3.00  3.50 
4.50 	4.00  10.50 
 10.50	5.00 

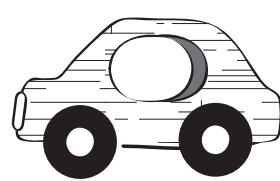
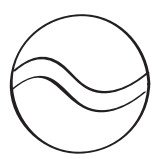

4.50

5.00

3.00

10.50

# RAHA

6b

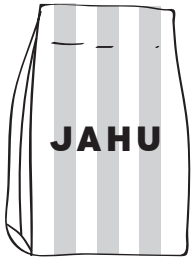

3.50

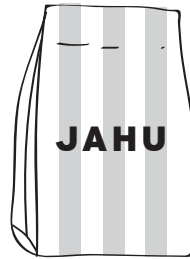

1.50



1.00

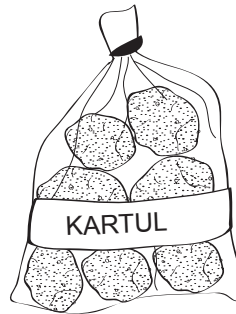

1.20

0.50

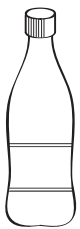

2.00

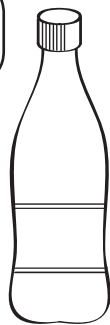

2.00

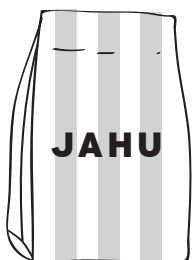
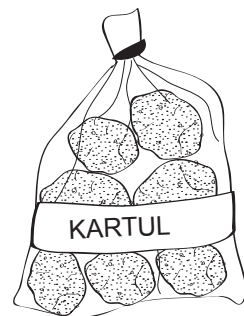

1.50



1.00

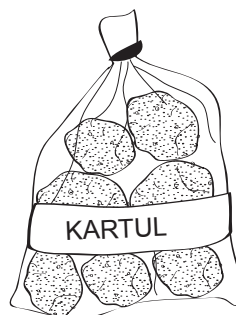

1.20

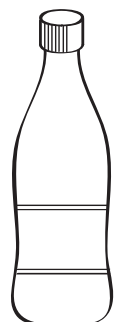

0.50

0.60

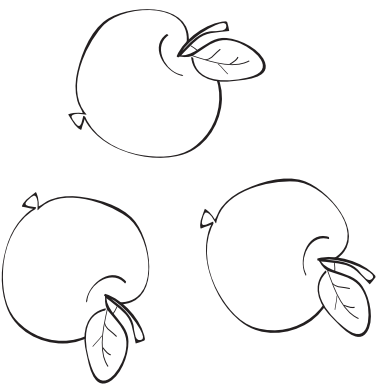

0.99

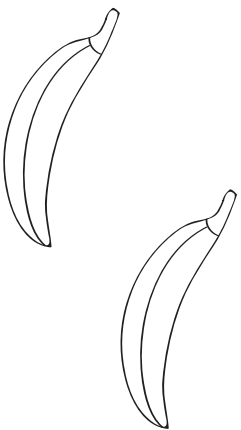

0.45

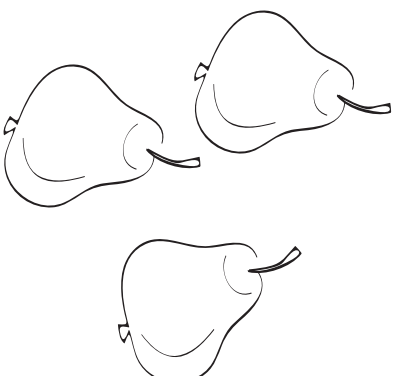

0.78

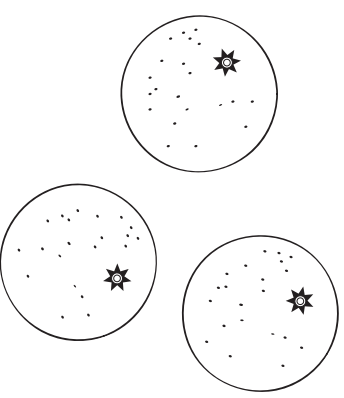

1. ÕUNTE HIND ON \_\_\_\_\_ SENTI.
2. BANNAANIDE HIND ON \_\_\_\_\_ SENTI.
3. PIRNIDE HIND ON \_\_\_\_\_ SENTI.
4. APELSINIDE HIND ON \_\_\_\_\_ SENTI.

# RAHA

7b

300.00

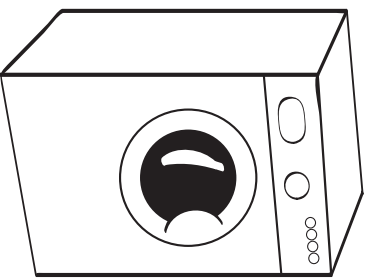

425.00

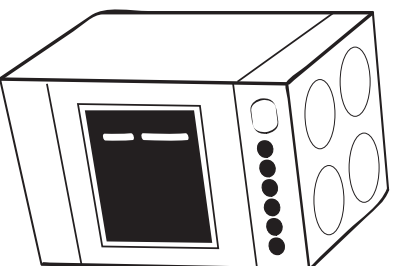

69.00

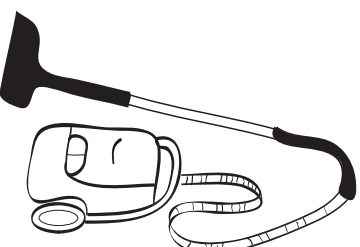

219.00



1. TELERI HIND ON \_\_\_\_\_ EUROT.

2. PLIIDI HIND ON \_\_\_\_\_ EUROT.

3. TOLMU-IMEJA HIND ON \_\_\_\_\_ EUROT.

4. PESU-MASINA HIND ON \_\_\_\_\_ EUROT.

9.90



15.70

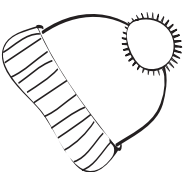

33.60

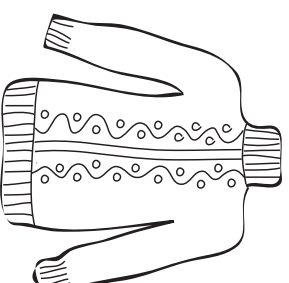

109.20

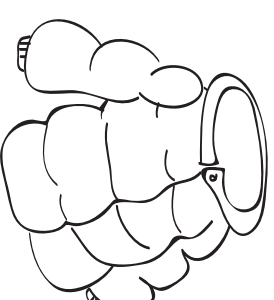

SALLI HIND ON \_\_\_\_\_ EUROT JA \_\_\_\_\_ SENTI.

JOPE HIND ON \_\_\_\_\_ EUROT JA \_\_\_\_\_ SENTI.

MÜTSI HIND ON \_\_\_\_\_ EUROT JA \_\_\_\_\_ SENTI.

KAMPSUNI HIND ON \_\_\_\_\_ EUROT JA \_\_\_\_\_ SENTI.

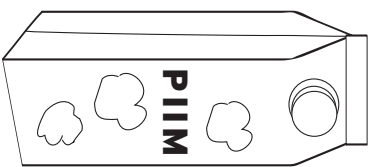

0.56

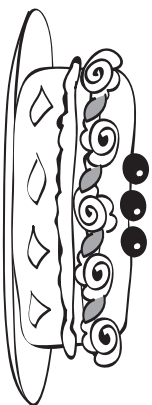

11.00

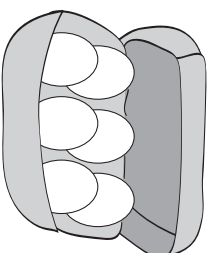

1.00

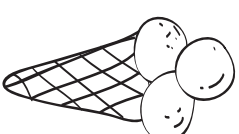

0.79

PIIMA HIND ON \_\_\_\_\_ SENTI / EUROOT.

TORDI HIND ON \_\_\_\_\_ SENTI / EUROOT.

MUNADE HIND ON \_\_\_\_\_ SENTI / EUROOT.

JÄÄTISE HIND ON \_\_\_\_\_ SENTI / EUROOT.

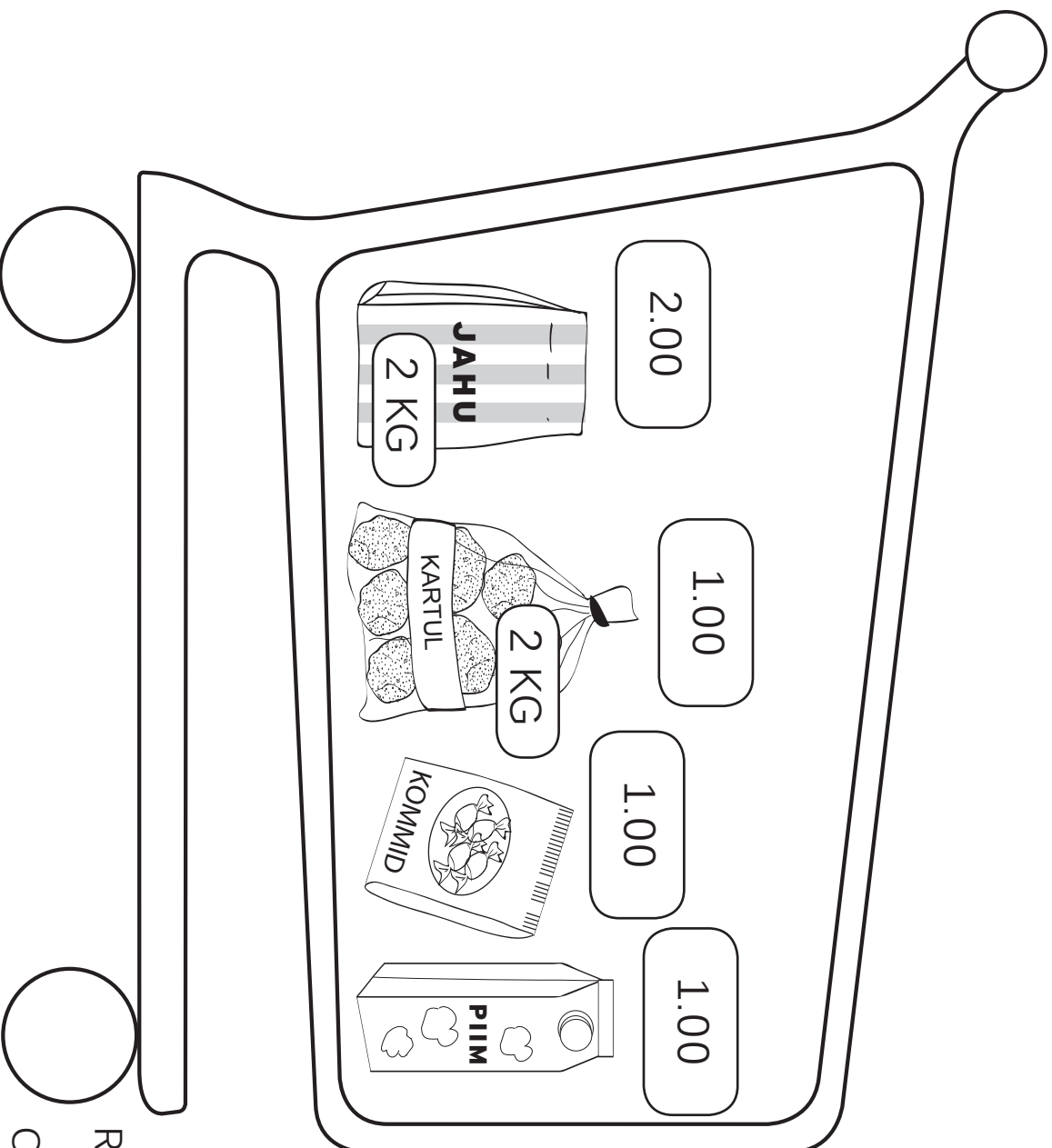

## OSTU-NIME-KIRI

2 KG JAHU \_\_\_\_\_ EUROT.

2 KG KARTULEID \_\_\_\_\_ EURO.

1 PAKK PIIMA \_\_\_\_\_ EURO.

1 PAKK KOMMI \_\_\_\_\_ EURO.

KOKKU MAKSAVAD \_\_\_\_\_ EUROT.

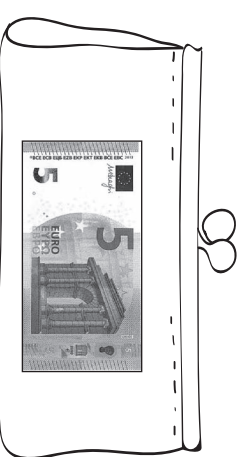

RAHA-KOTIS ON RAHA \_\_\_\_\_ EUROT.

OSTUKS RAHA JÄTKUB / EI JÄTKU.



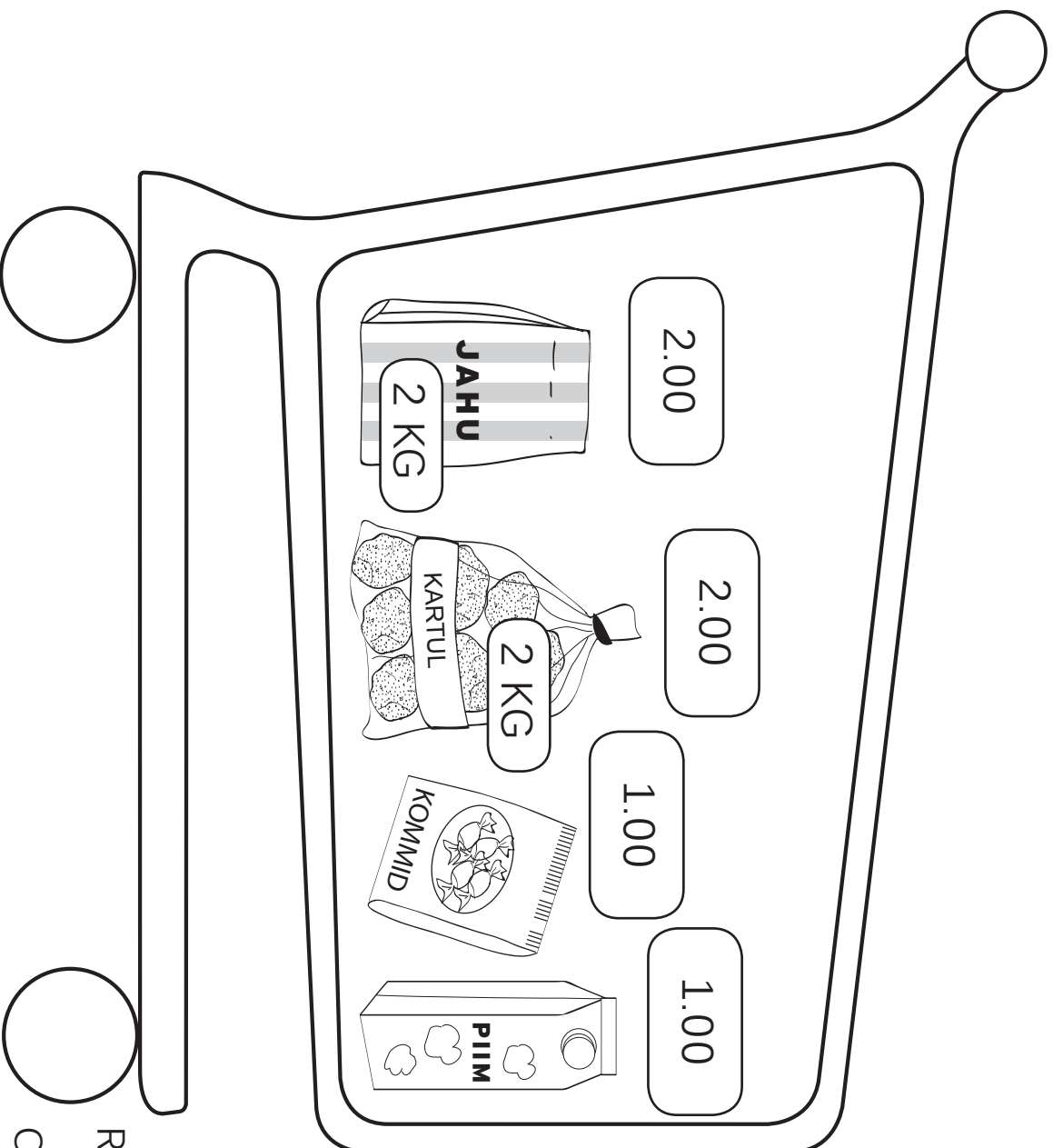

## OSTU-NIME-KIRI

- 2 KG JAHU \_\_\_\_\_ EURO.  
2 KG KARTULEID \_\_\_\_\_ EURO.  
1 PAKK PIIMA \_\_\_\_\_ EURO.  
1 PAKK KOMMI \_\_\_\_\_ EURO.

KOKKU MAKSAVAD \_\_\_\_\_ EURO.

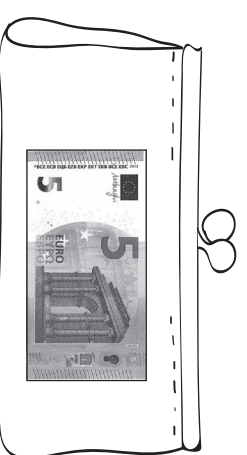

RAHA-KOTIS ON RAHA \_\_\_\_\_ EURO.

OSTUKS RAHA JÄTKUB / EI JÄTKU.

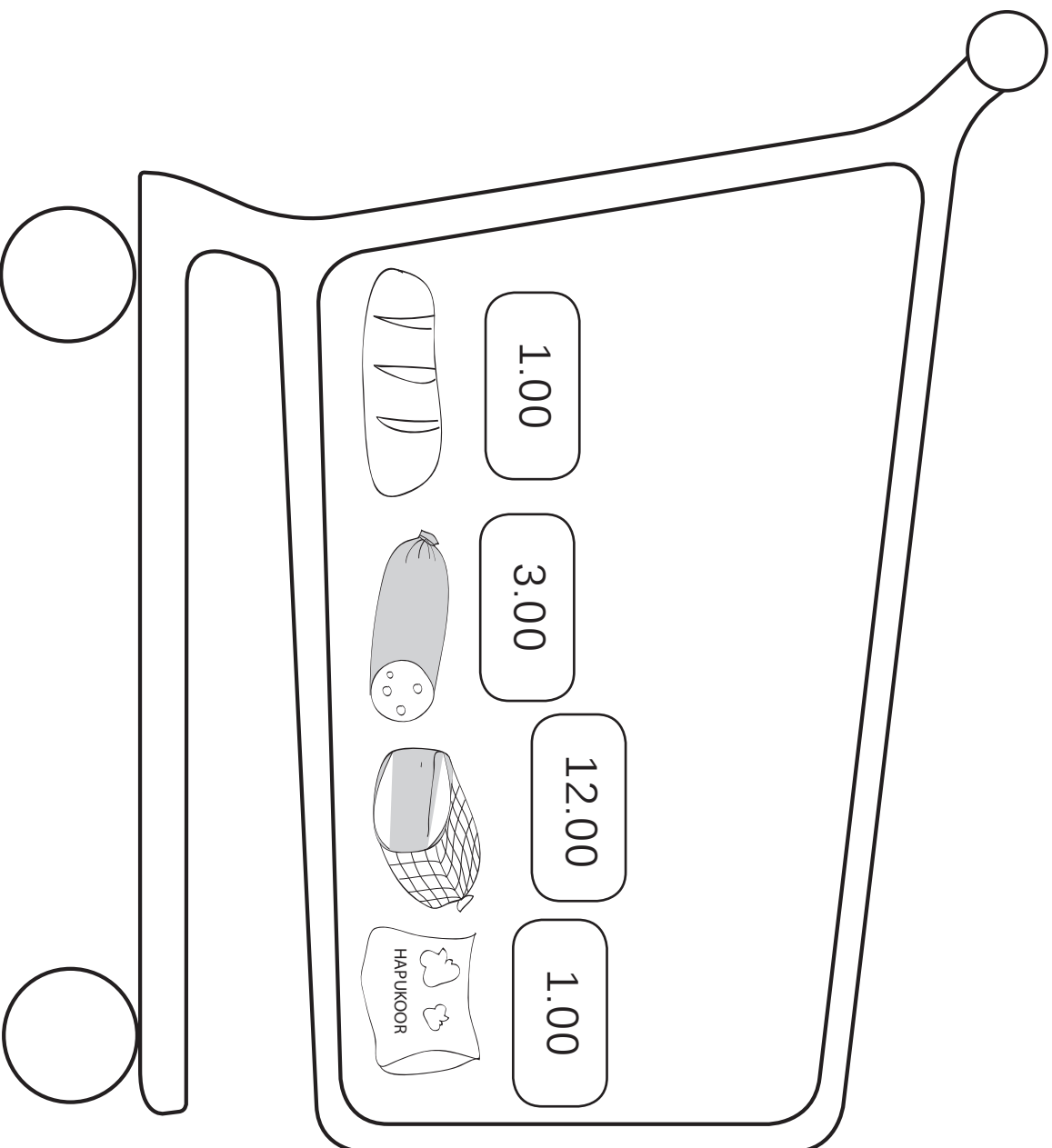

## OSTU-NIME-KIRI

- 1 SAI \_\_\_\_\_ EURO.  
1 KG VORSTI \_\_\_\_\_ EURO.  
3 KG SINKI \_\_\_\_\_ EURO.  
1 PAKK KOORT \_\_\_\_\_ EURO.

KOKKU MAKSAVAD \_\_\_\_\_ EURO.

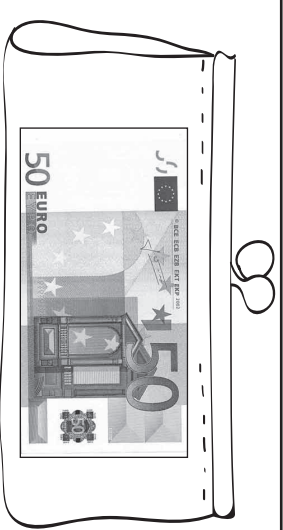

RAHA ON \_\_\_\_\_ EURO.

OSTUKS RAHA JÄTKUB / EI JÄTKU.

SAAN / EI SAA RAHA TAGASI.

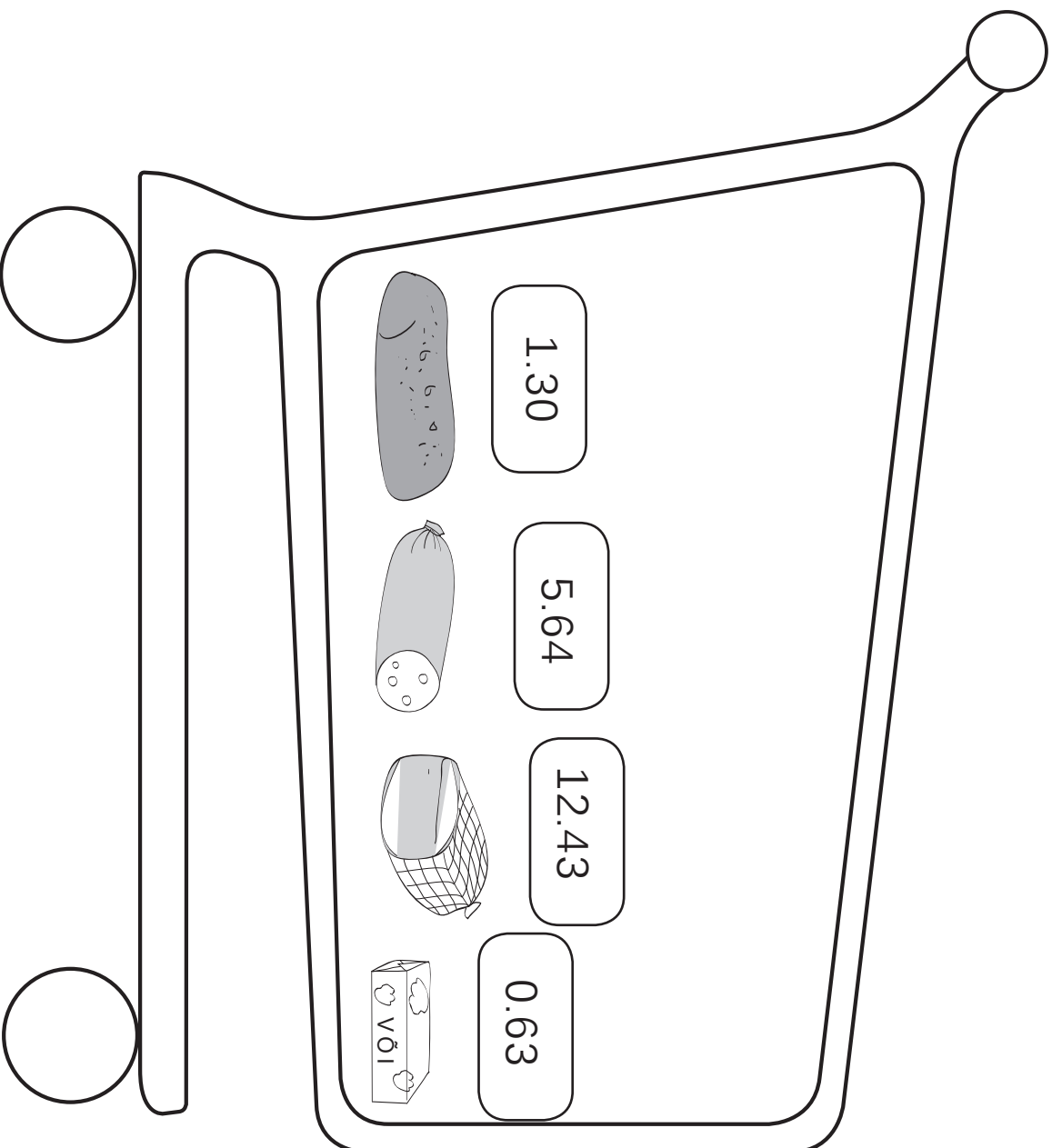

## OSTU-NIME-KIRI

- 1 LEIB \_\_\_\_\_ € JA \_\_\_\_\_ S.  
 1 KG VORSTI \_\_\_\_\_ € JA \_\_\_\_\_ S.  
 3 KG SINKI \_\_\_\_\_ € JA \_\_\_\_\_ S.  
 1 PAKK VÕID \_\_\_\_\_ € JA \_\_\_\_\_ S.

KOKKU \_\_\_\_\_ € JA \_\_\_\_\_ S.

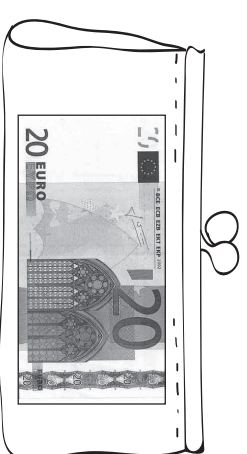

RAHA ON \_\_\_\_\_ EUROOT.

OSTUKS RAHA JÄTKUB / EI JÄTKU.

SAAN / EI SAA RAHA TAGASI.

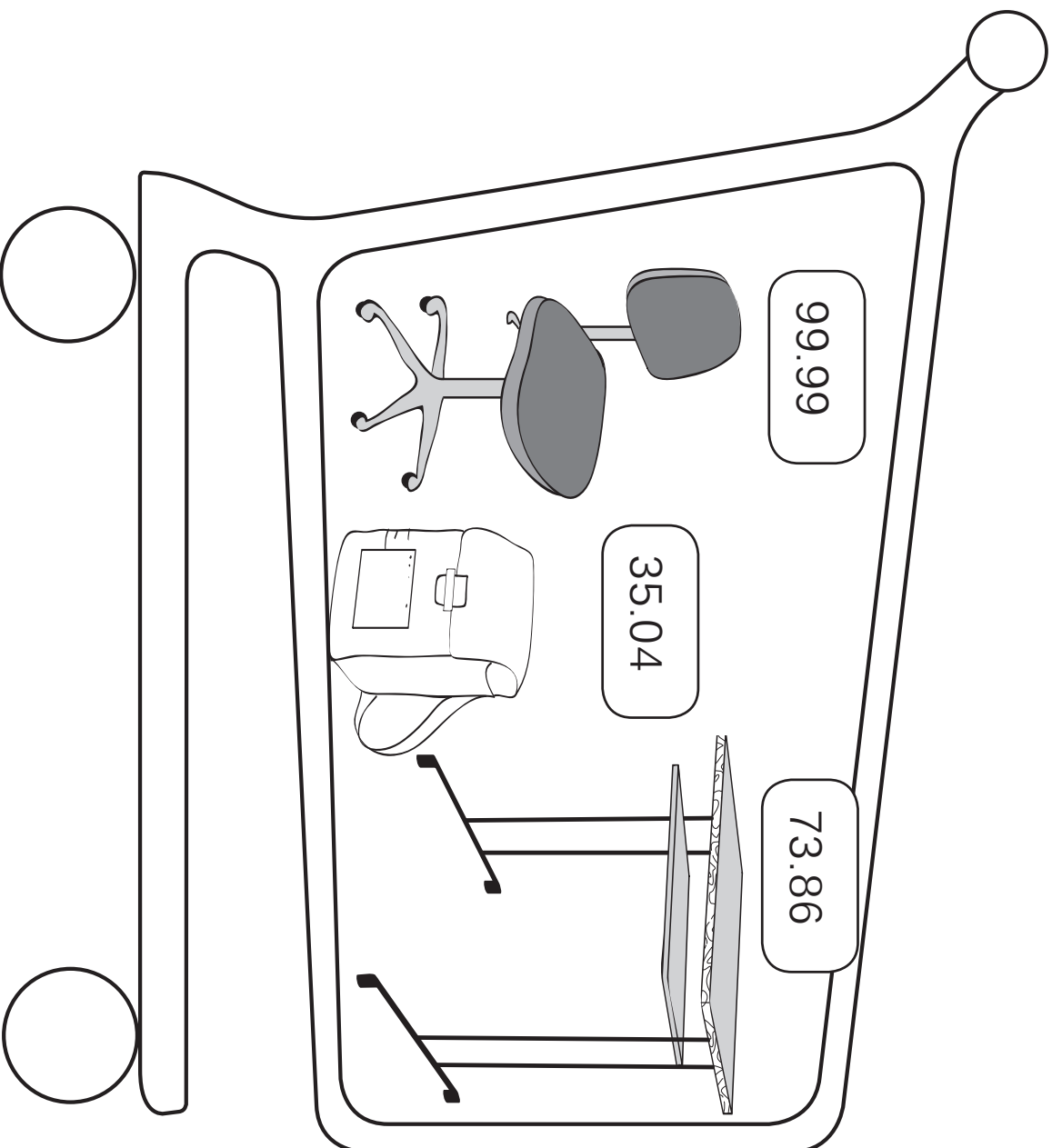

## OSTU-NIME-KIRI

1 TOOL \_\_\_\_\_ € JA \_\_\_\_\_ S.

1 RANITS \_\_\_\_\_ € JA \_\_\_\_\_ S.

3 1 LAUD \_\_\_\_\_ € JA \_\_\_\_\_ S.

KOKKU \_\_\_\_\_ € JA \_\_\_\_\_ S.

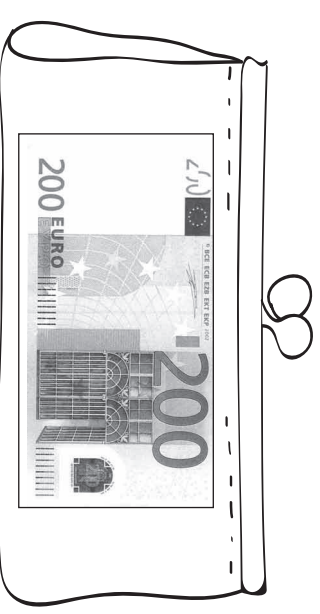

RAHA ON \_\_\_\_\_ EUROOT.

OSTUKS RAHA JÄTKUB / EI JÄTKU.

SAAN / EI SAA RAHA TAGASI.

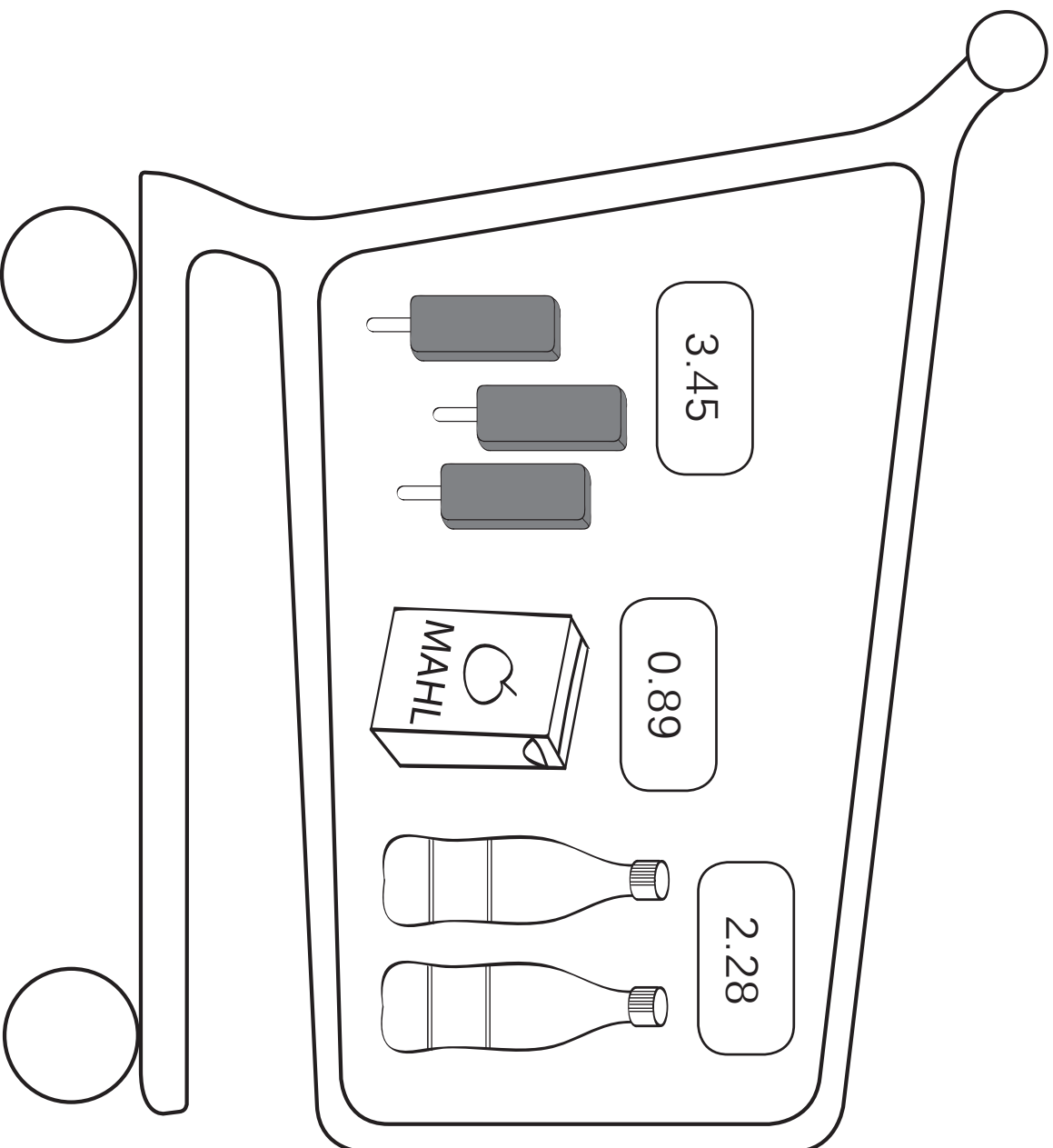

## OSTU-NIME-KIRI

- 3 JÄÄTIST \_\_\_\_\_ € JA \_\_\_\_\_ S.  
 1 PAKK MAHLA \_\_\_\_\_ € JA \_\_\_\_\_ S.  
 2 LIMONAADI \_\_\_\_\_ € JA \_\_\_\_\_ S.

KOKKU \_\_\_\_\_ € JA \_\_\_\_\_ S.

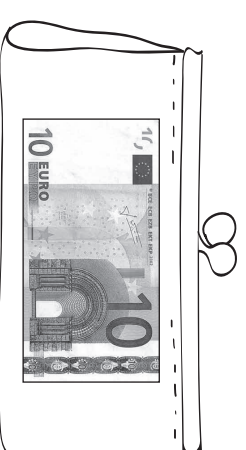

RAHA ON \_\_\_\_\_ EUROOT.

OSTUKS RAHA JÄTKUB / EI JÄTKU.

SAAN / EI SAA RAHA TAGASI.

# KELL

1

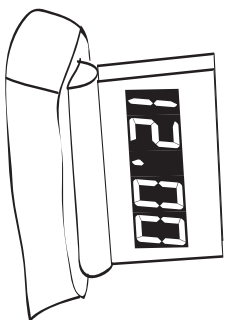

ÄRATUS-KELL



KÄE-KELL

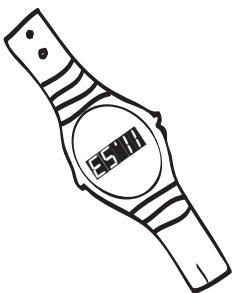

LAUA-KELL

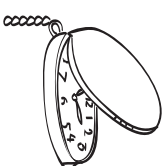

SEINA-KELL



TASKU-KELL

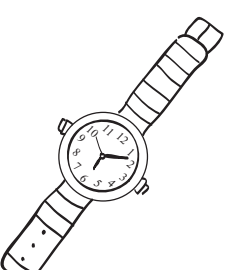
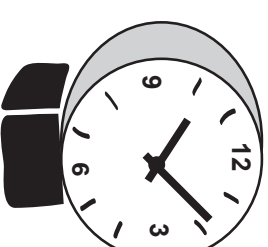
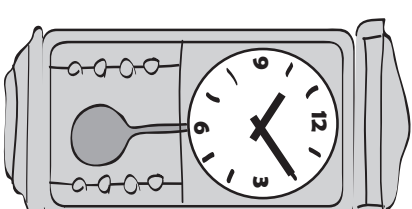
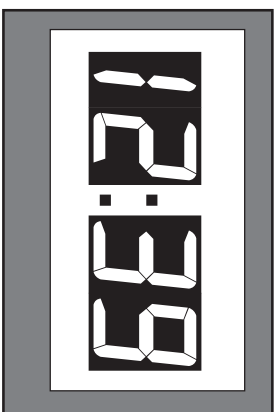

# KELL

2

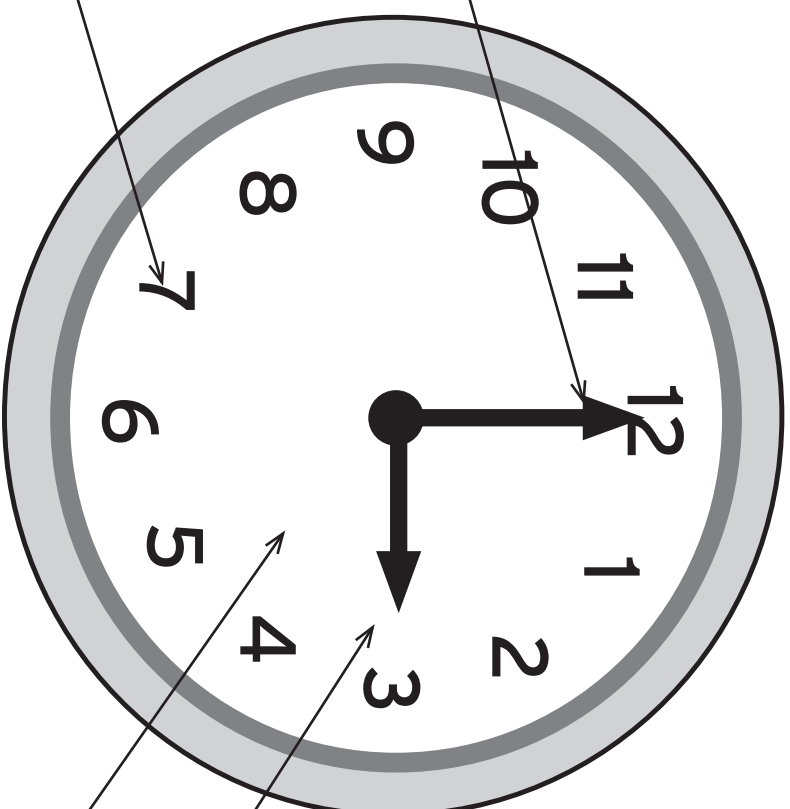

SUUR OSUTI

VÄIKE OSUTI

NUMBRI-LAUD

KELLA-NUMBER

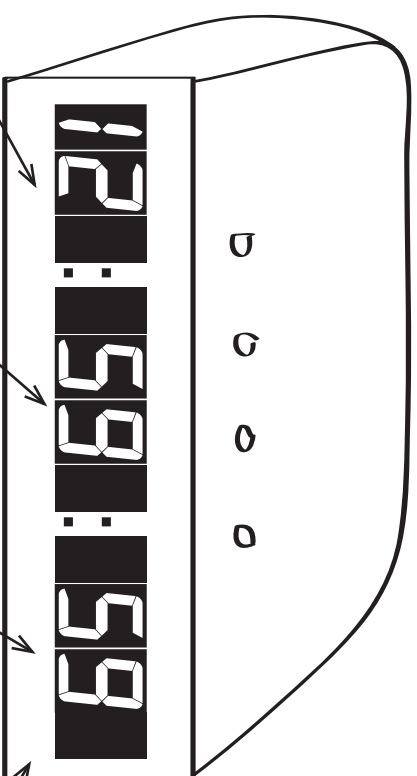

TUNNID	MINUTID	SEKUNDID	NUMBRI-LAUD
--------	---------	----------	-------------



# KELL

4

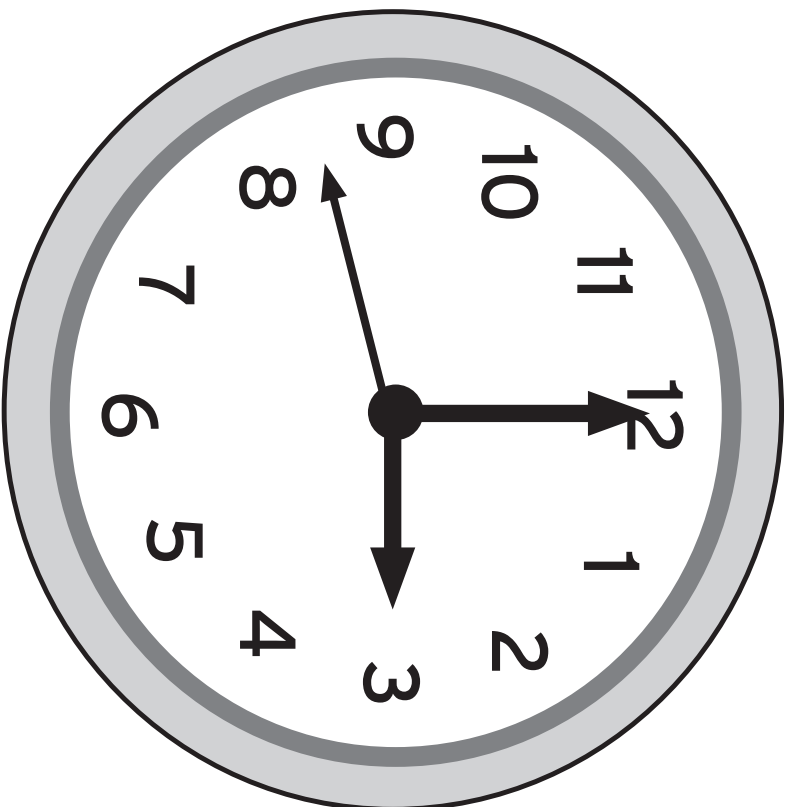

VÄIKE OSUTI NÄITAB \_\_\_\_\_

SUUR OSUTI NÄITAB \_\_\_\_\_

SEKUNDI-OSUTI LIIGUB VÄGA \_\_\_\_\_

SEKUNDI-OSUTI LOENDAB \_\_\_\_\_

OSUTI KOHTA VÕIB ÕELDA KA \_\_\_\_\_

TUNDE	MINUTEID	KIIRESTI	SEKUNDEID	SEIER
-------	----------	----------	-----------	-------

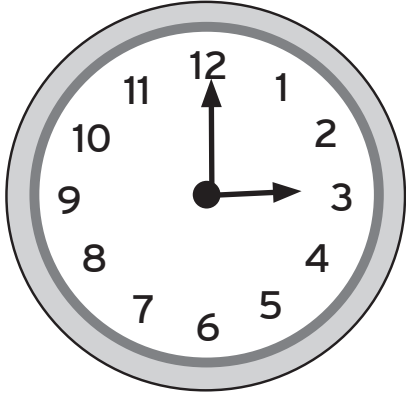

KELL ON \_\_\_\_\_.

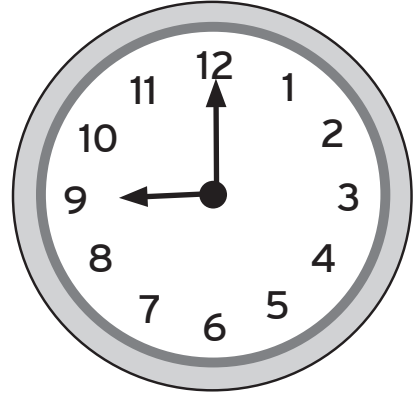

KELL ON \_\_\_\_\_.

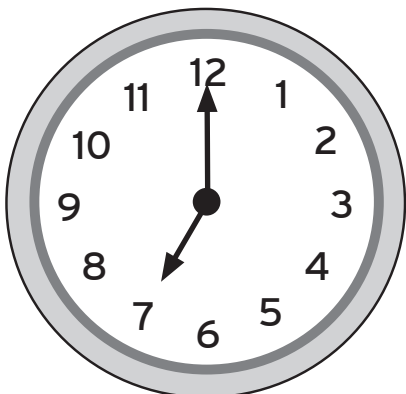

KELL ON \_\_\_\_\_.

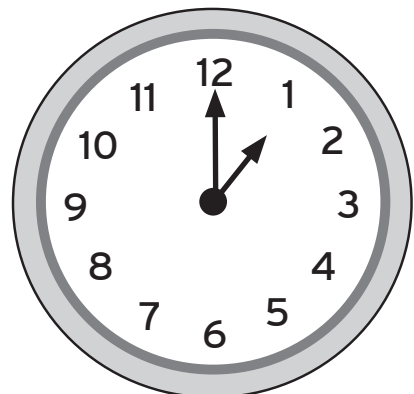

KELL ON \_\_\_\_\_.

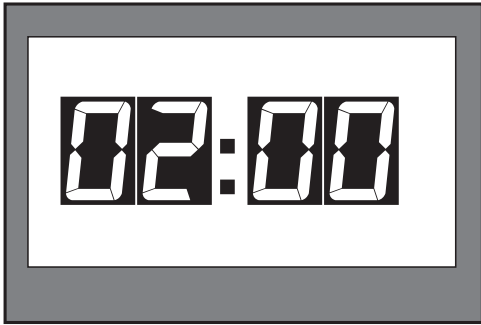

KELL ON \_\_\_\_\_.

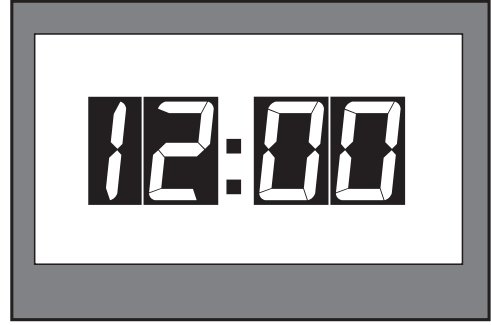

KELL ON \_\_\_\_\_.

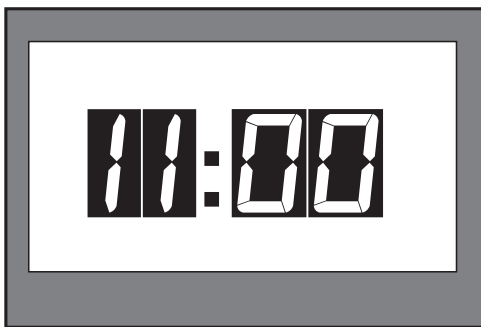

KELL ON \_\_\_\_\_.

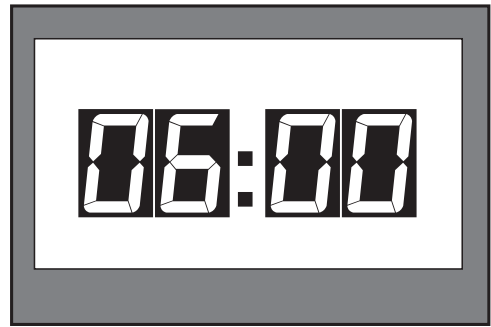

KELL ON \_\_\_\_\_.

KELL ON \_\_\_\_\_.

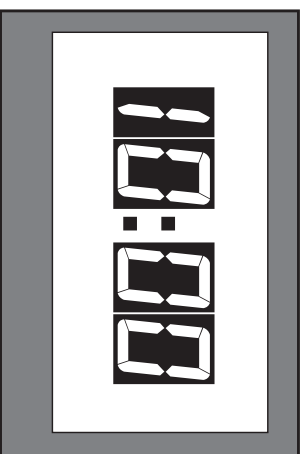
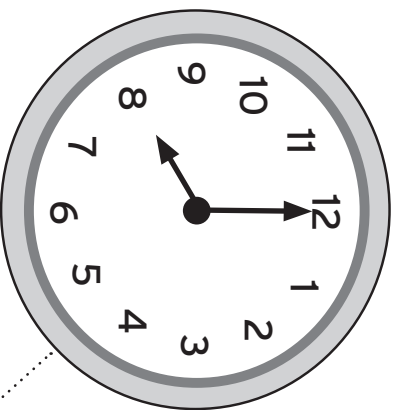

KELL ON \_\_\_\_\_.

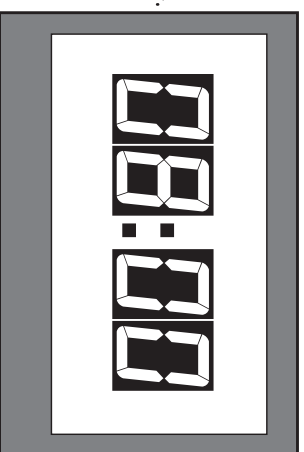
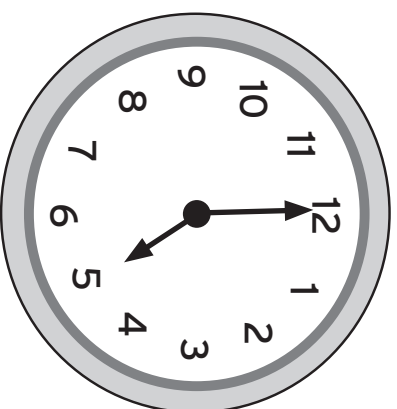

KELL ON \_\_\_\_\_.

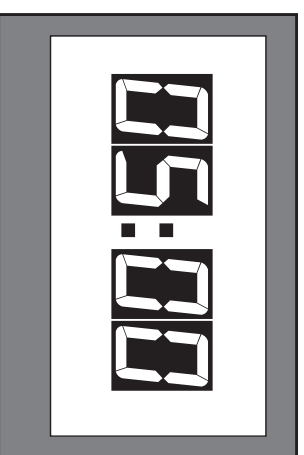
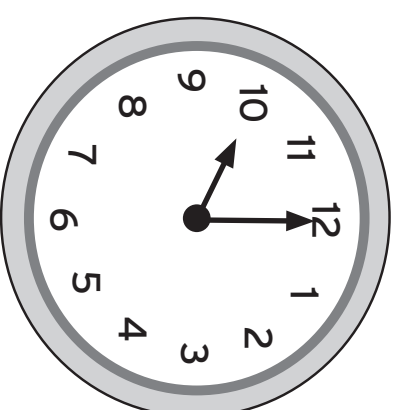

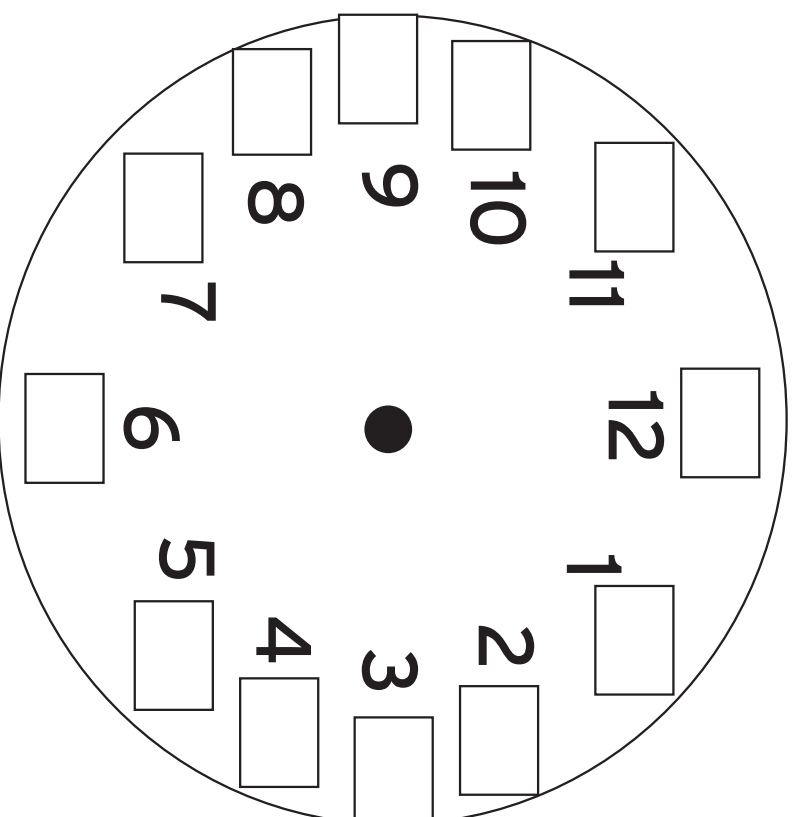
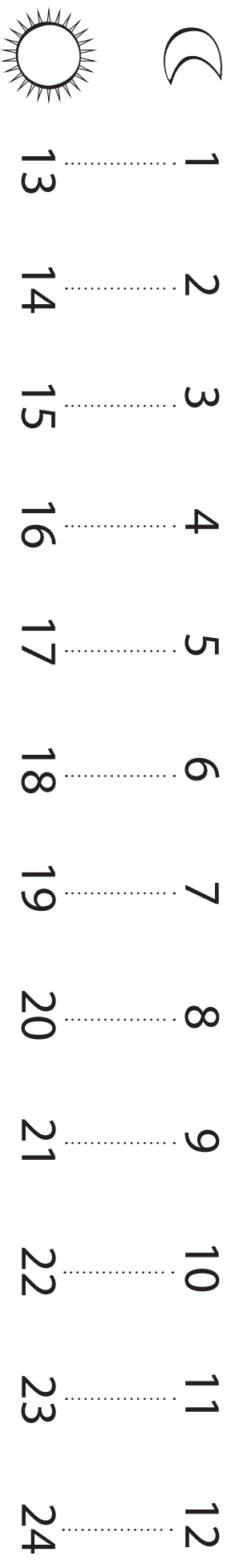

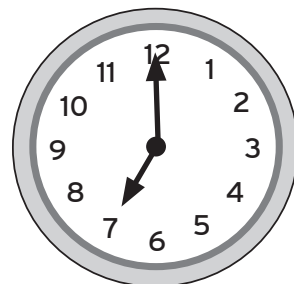
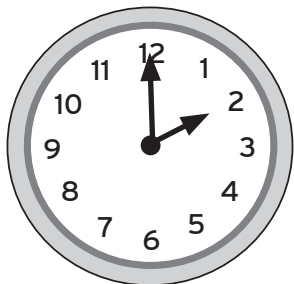
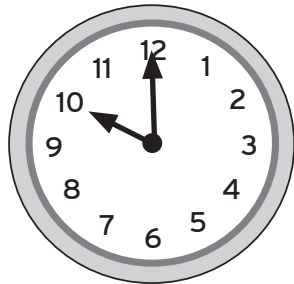
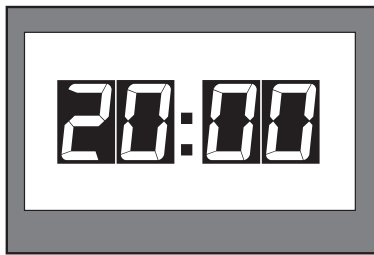
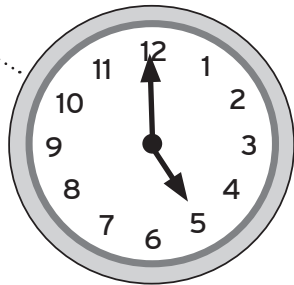
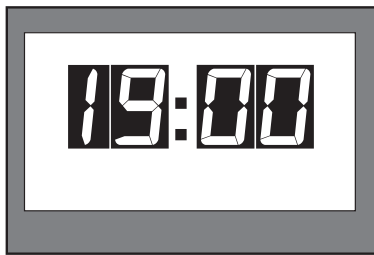
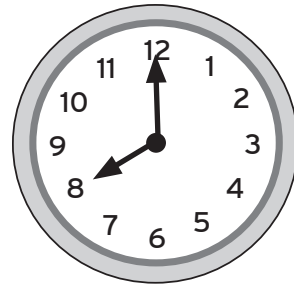
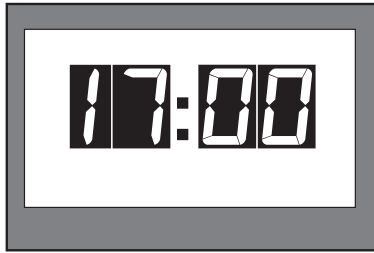

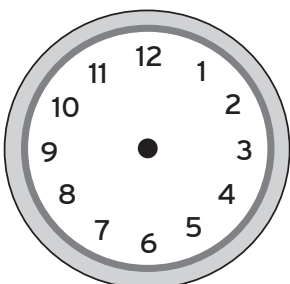
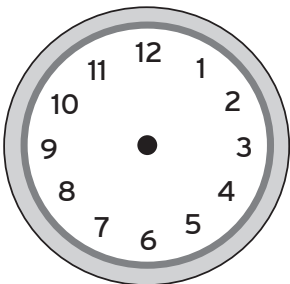
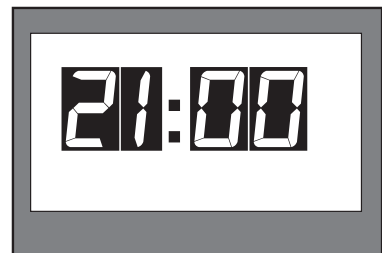
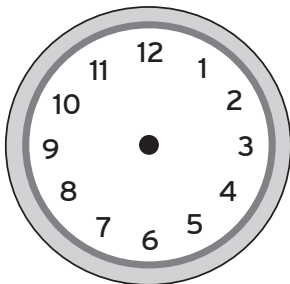
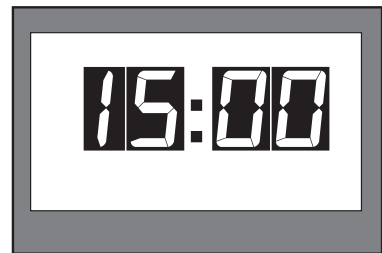
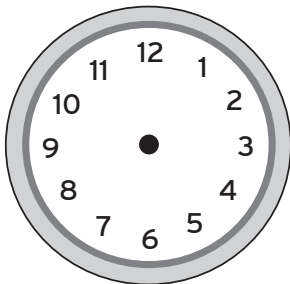
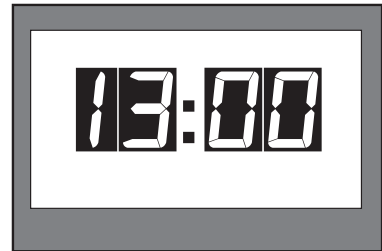
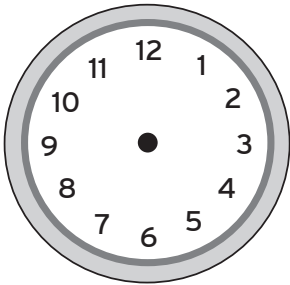

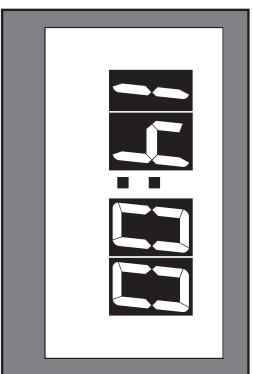

KELL ON \_\_\_\_\_

EHK

KELL ON \_\_\_\_\_ PÄEVAL.

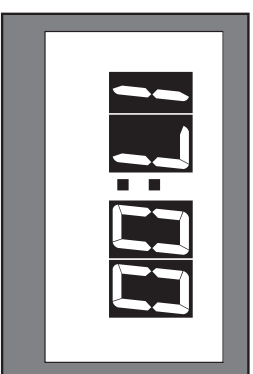

KELL ON \_\_\_\_\_

EHK

KELL ON \_\_\_\_\_ ÕHTUL.

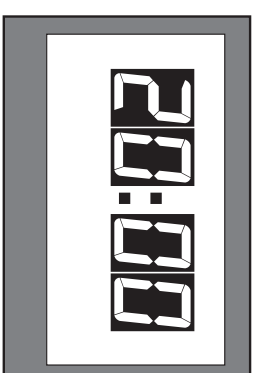

KELL ON \_\_\_\_\_

EHK

KELL ON \_\_\_\_\_ ÕHTUL.



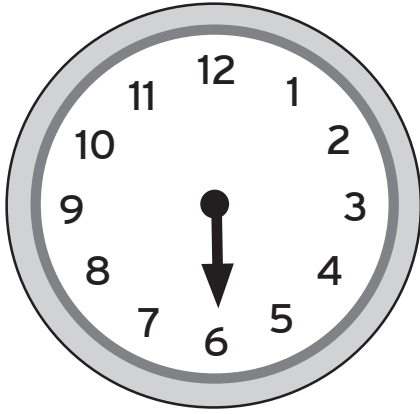

KELL ON 6.

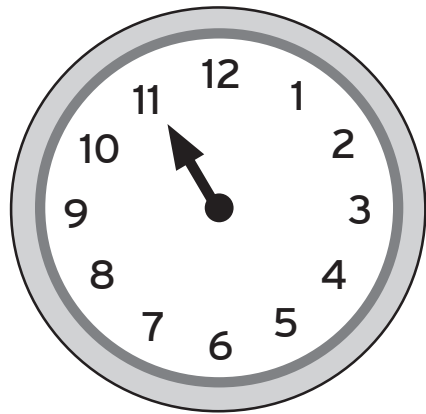

KELL ON 11.

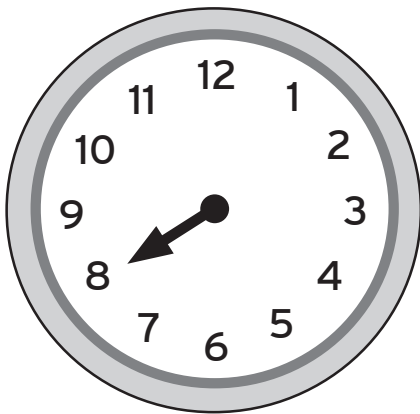

KELL ON 20.

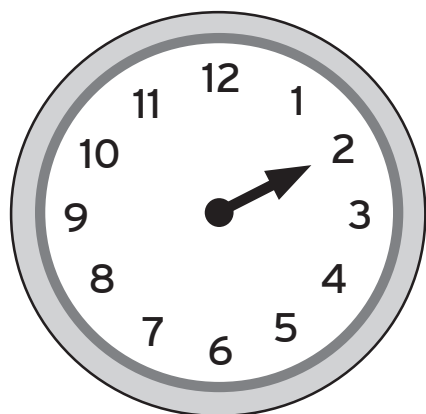

KELL ON 14.

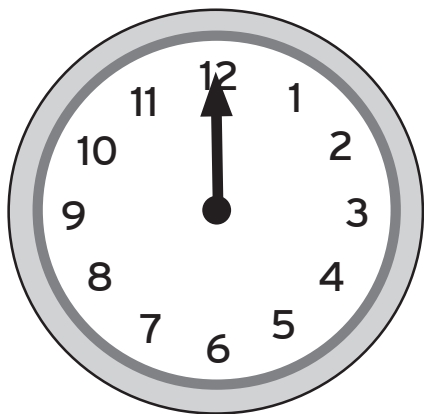

KELL ON 5.

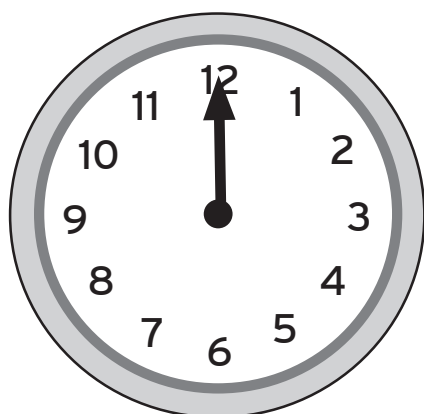

KELL ON 10.

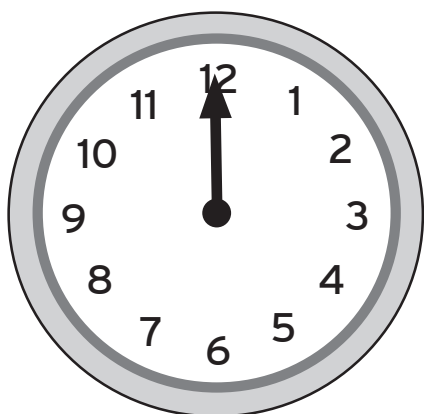

KELL ON 21.

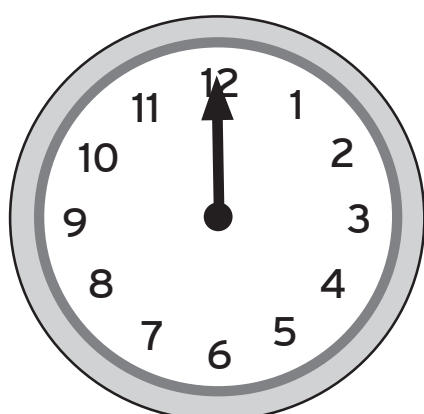

KELL ON 13.

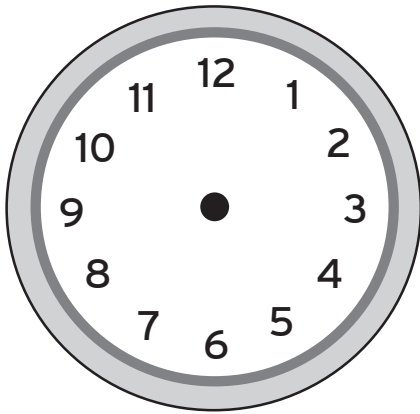

KELL ON 3.

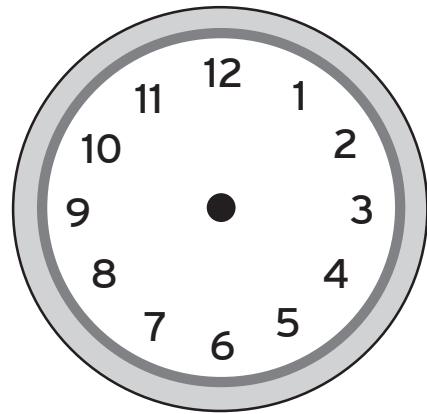

KELL ON 8.

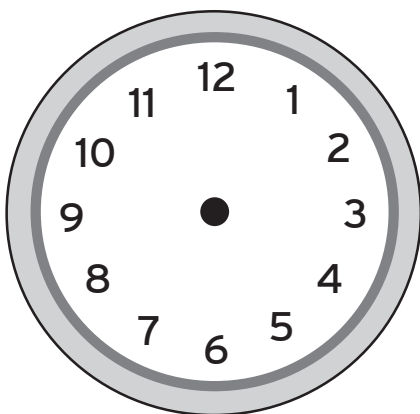

KELL ON 20.

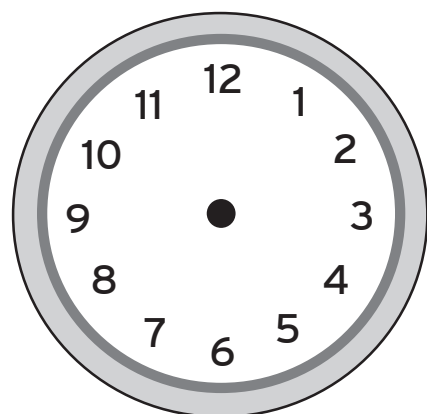

KELL ON 17.

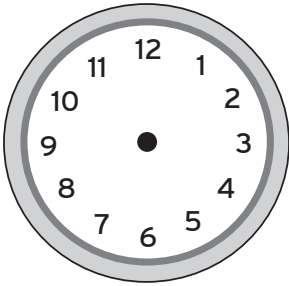

KELL ON 8.

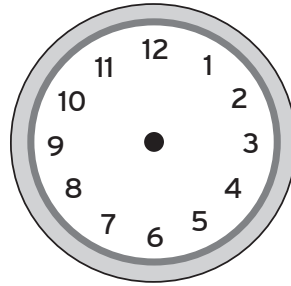

KELL ON 5.

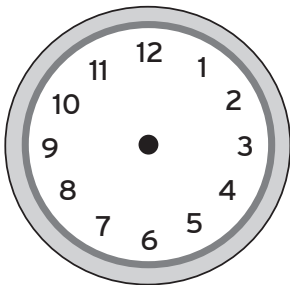

KELL ON 21.

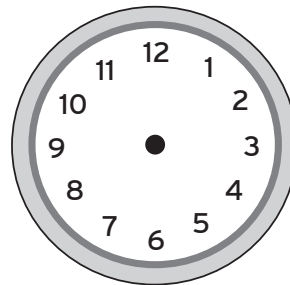

KELL ON 13.

08.00

05.00

21.00

13.00

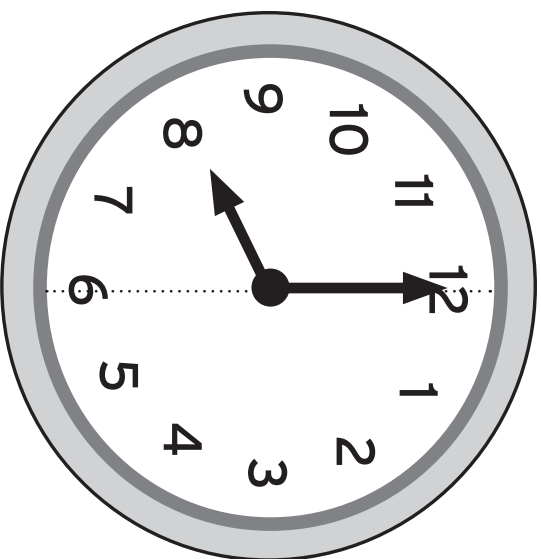

KELL ON \_\_\_\_\_.

MÖÖDUB  
POOL TUNDI.

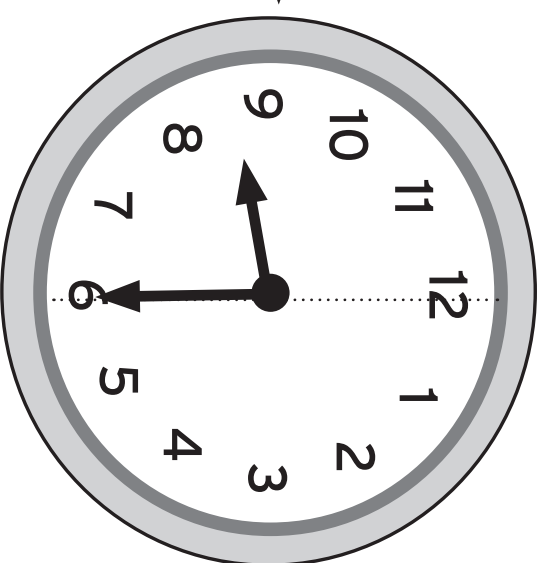

KELL ON POOL \_\_\_\_\_.

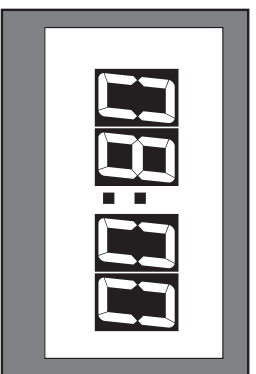
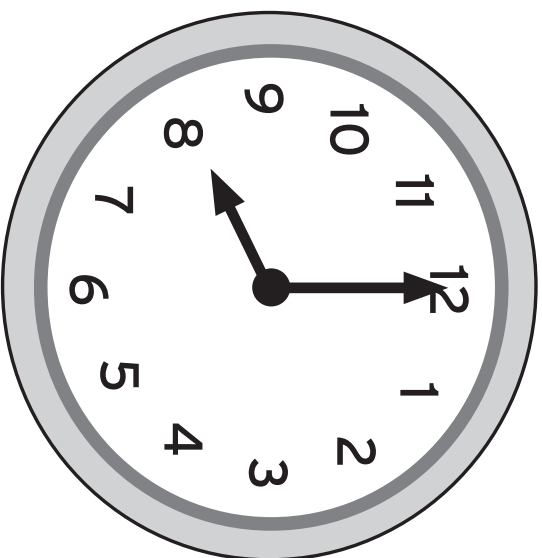

KELL ON \_\_\_\_\_.

MÖÖDUB  
POOL TUNDI

EHK 30 MINUTTIT.

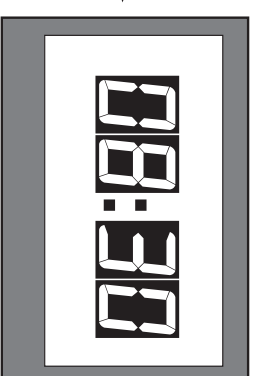
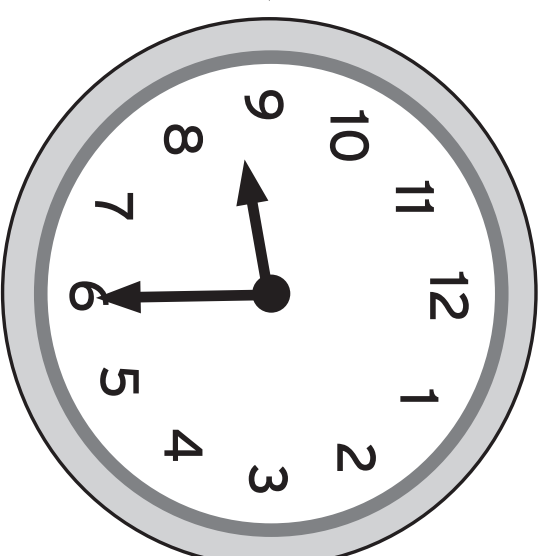

KELL ON POOL \_\_\_\_\_  
EHK \_\_\_\_\_.

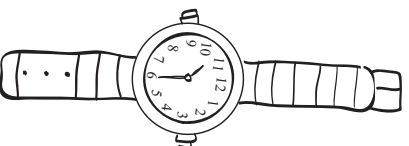
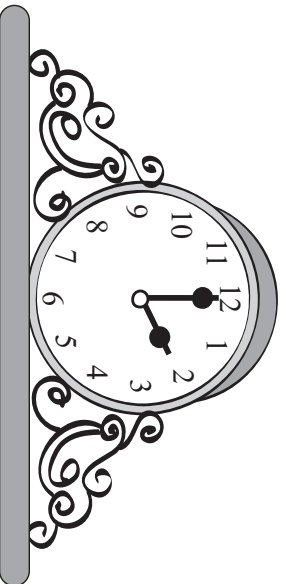
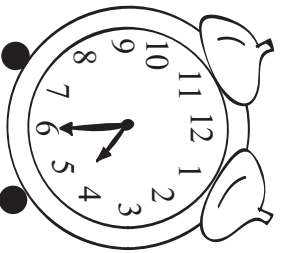
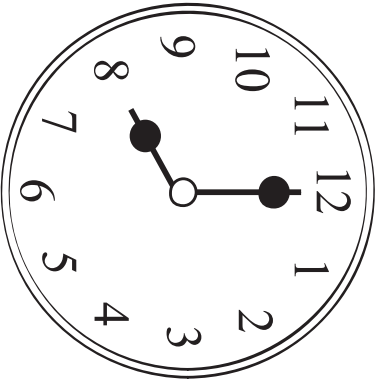
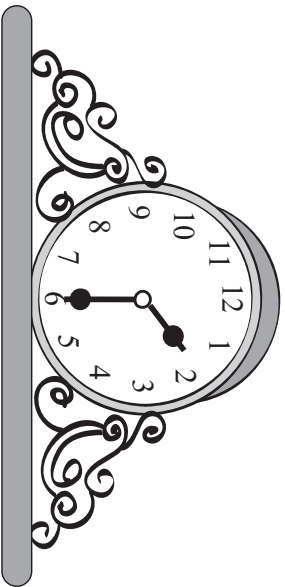
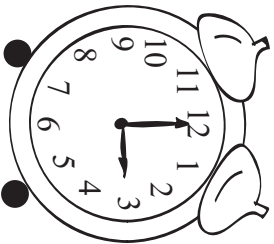
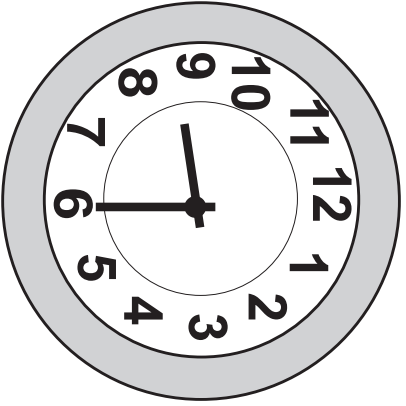
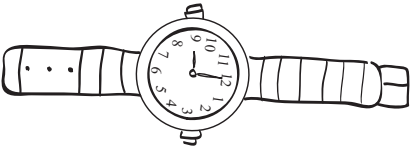

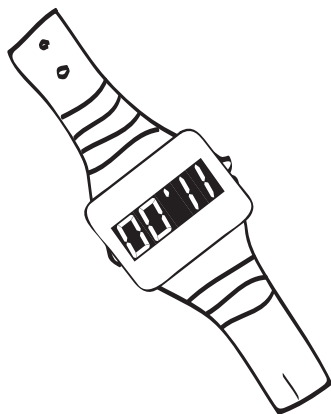
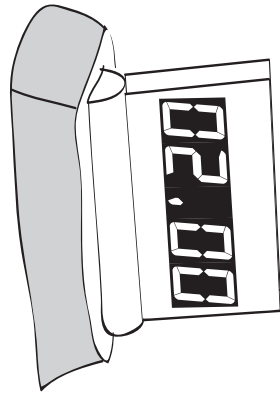
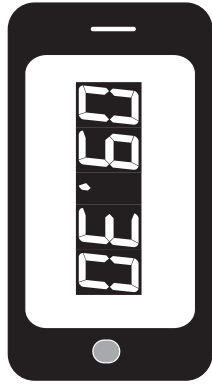
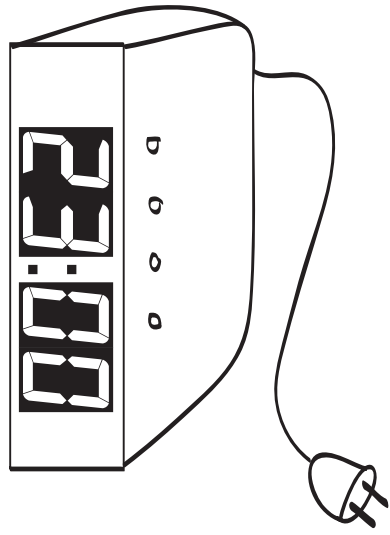
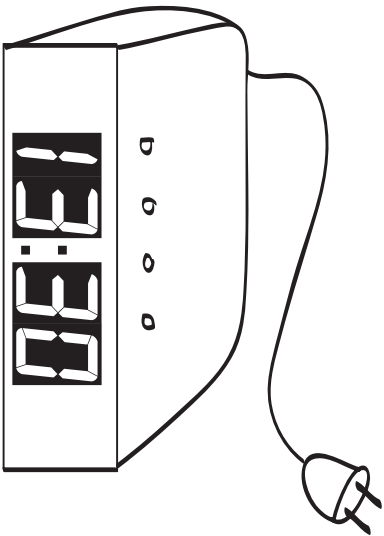
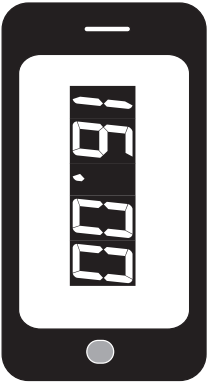
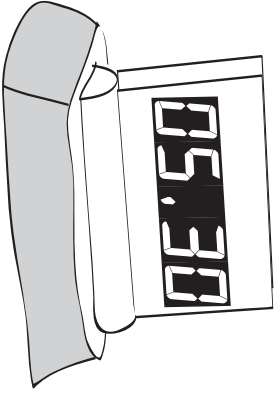
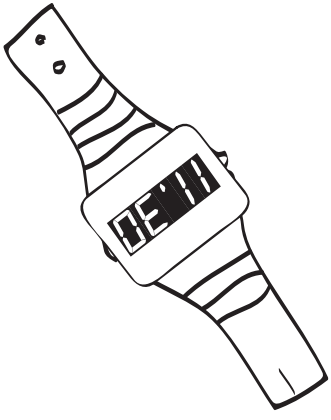

**KELL**

**10b**



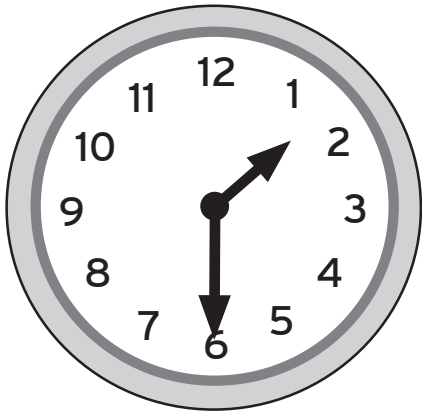

KELL ON POOL \_\_\_\_\_.

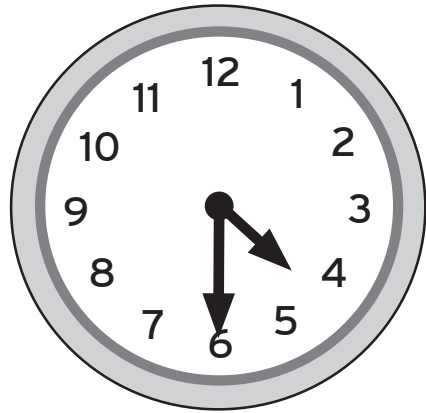

KELL ON POOL \_\_\_\_\_.

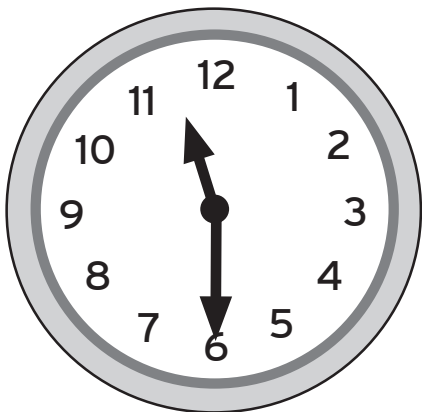

KELL ON POOL \_\_\_\_\_.

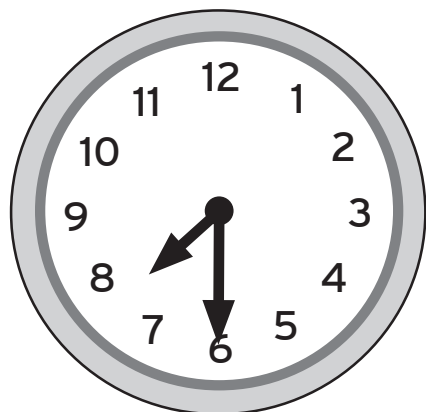

KELL ON POOL \_\_\_\_\_.

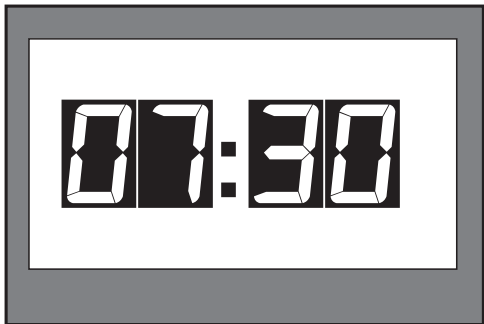

KELL ON \_\_\_\_\_.  
KELL ON POOL \_\_\_\_\_  
HOMMIKUL / ÕHTUL.

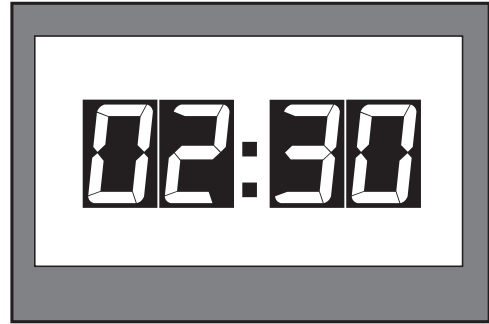

KELL ON \_\_\_\_\_.  
KELL ON POOL \_\_\_\_\_  
HOMMIKUL / ÕHTUL.

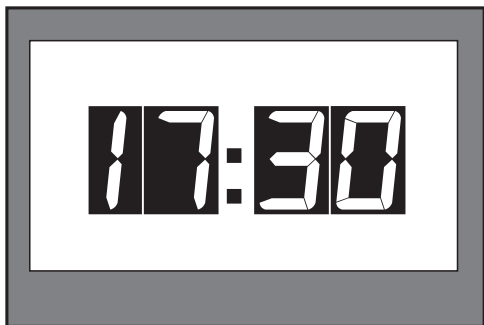

KELL ON \_\_\_\_\_.  
KELL ON POOL \_\_\_\_\_  
HOMMIKUL / ÕHTUL.



KELL ON \_\_\_\_\_.  
KELL ON POOL \_\_\_\_\_  
HOMMIKUL / ÕHTUL.

KELL ON POOL 7.

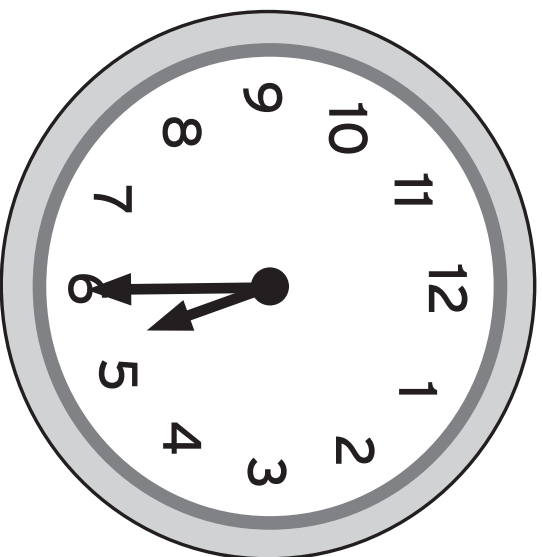

KELL ON POOL 6 ÖHTUL.

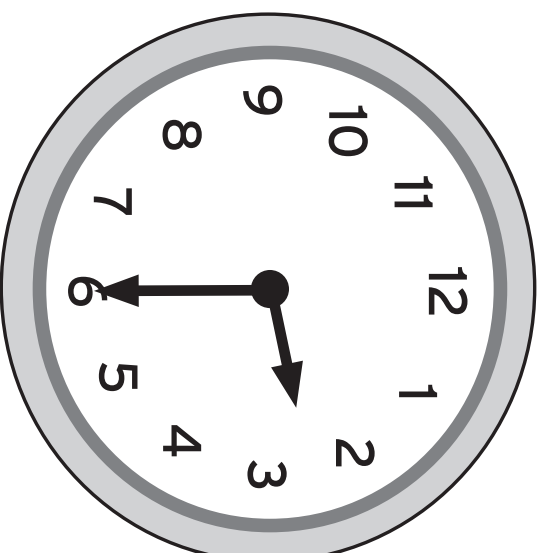

KELL ON 14.30.

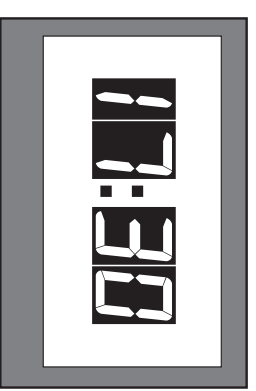
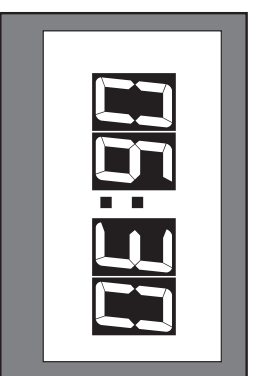
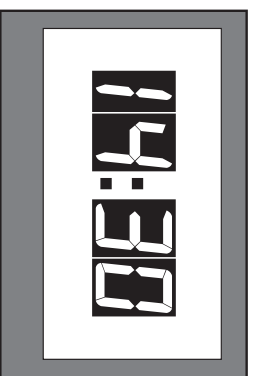
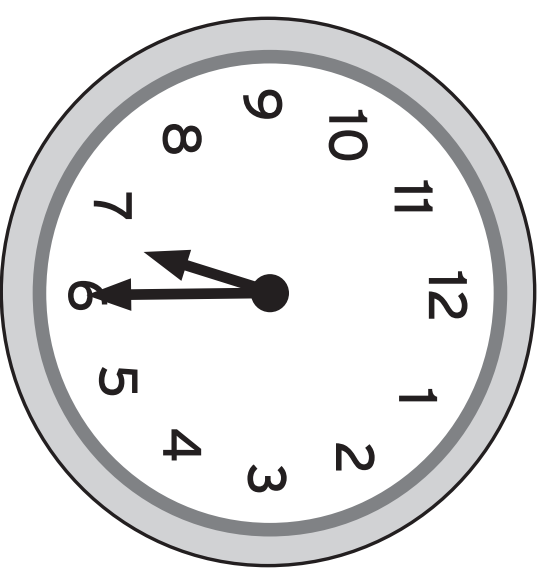

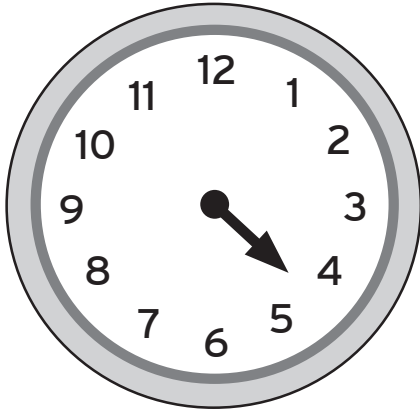

KELL ON POOL 5 ÕHTUL.

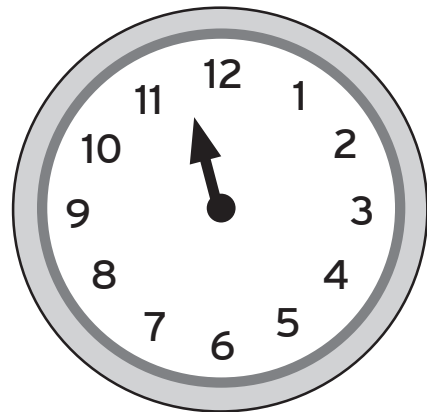

KELL ON 11.30.

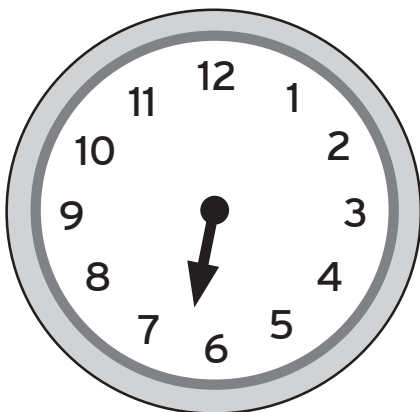

KELL ON POOL 7 HOMMIKUL.

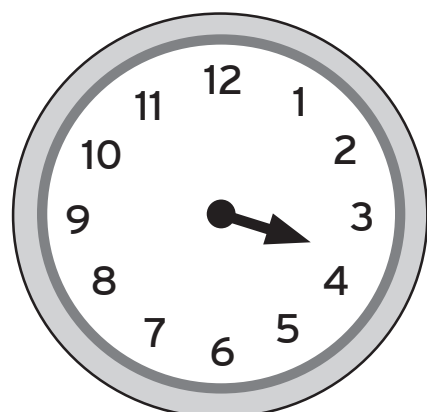

KELL ON 15.30.

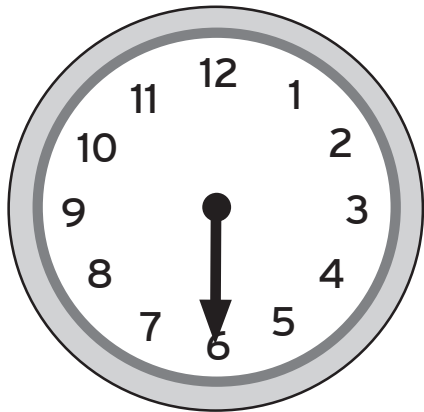

KELL ON POOL 6 ÕHTUL.

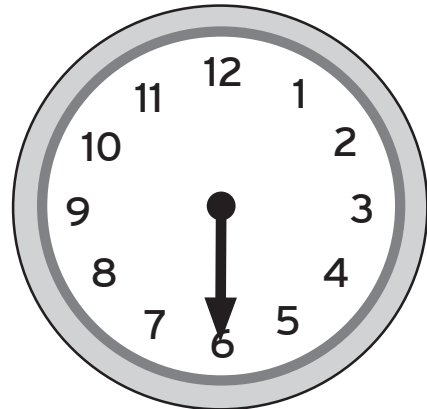

KELL ON 12.30.

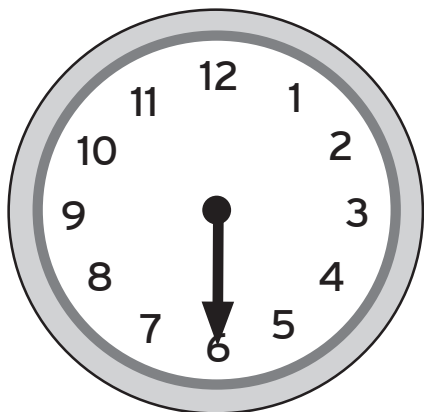

KELL ON POOL 1 PÄEVAL.

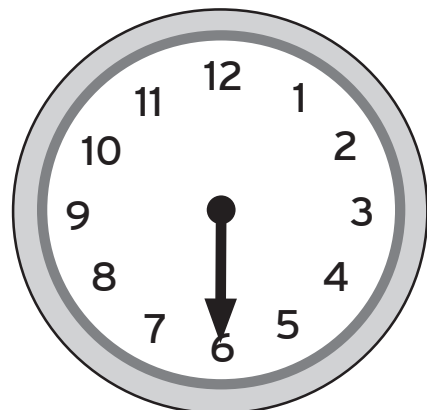

KELL ON 16.30.

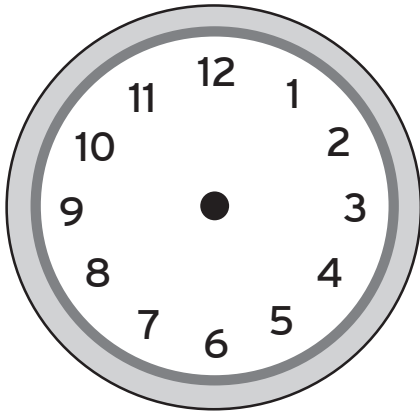

KELL ON 2.30.

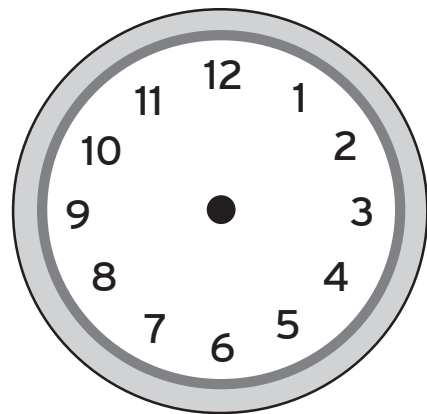

KELL ON 11.30.

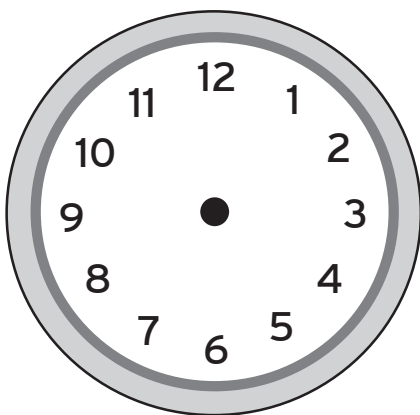

KELL ON POOL 7 ÕHTUL.

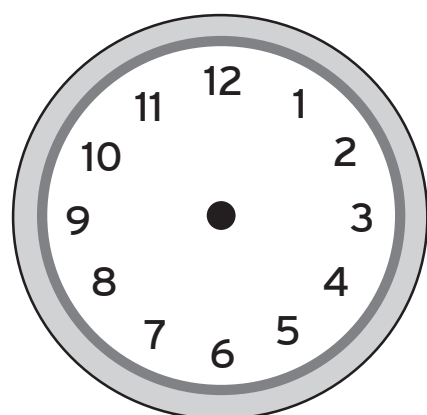

KELL ON 16.30.

# KELL

12d

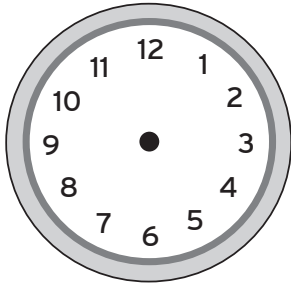

KELL ON POOL 2 PÄEVAL.

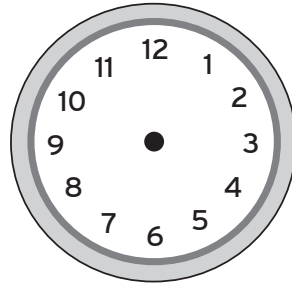

KELL ON POOL 8 ÕHTUL.

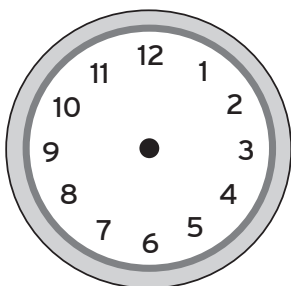

KELL ON POOL 6 ÕHTUL.

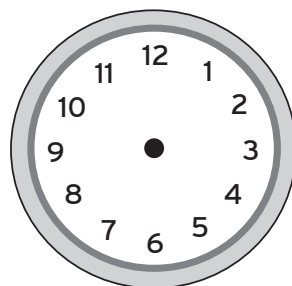

KELL ON POOL 12 PÄEVAL.

07.30

01.30

17.30

11.30

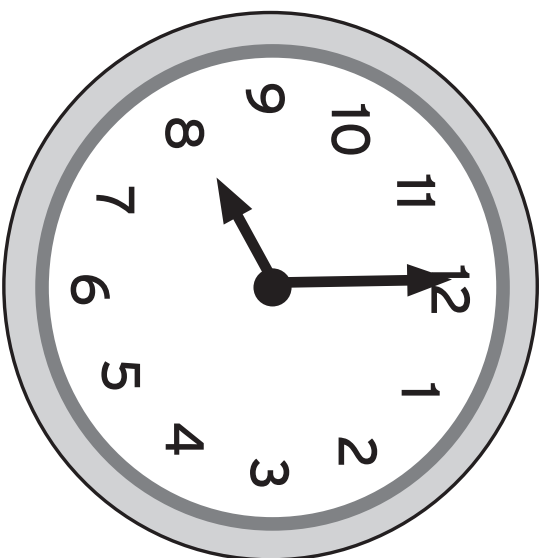

KELL ON \_\_\_\_\_.

MÖÖDUB  
1 TUND  
EHK 60 MINUTTIT.

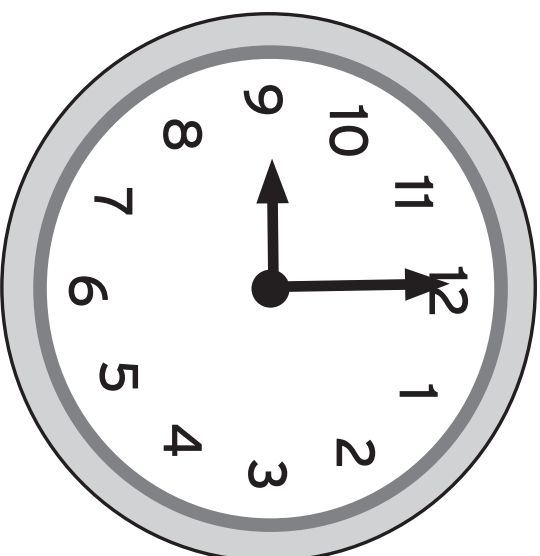

KELL ON \_\_\_\_\_.



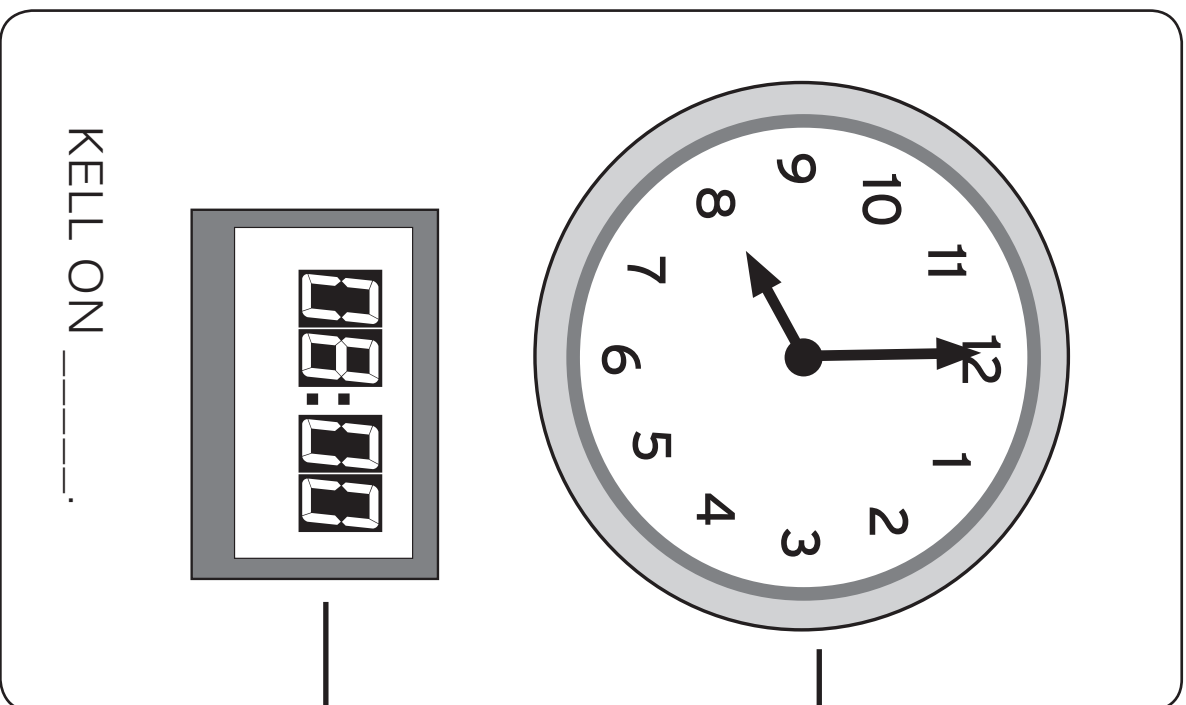

MÖÖDUB  
1 TUND  
EHK 60 MINUTIT.

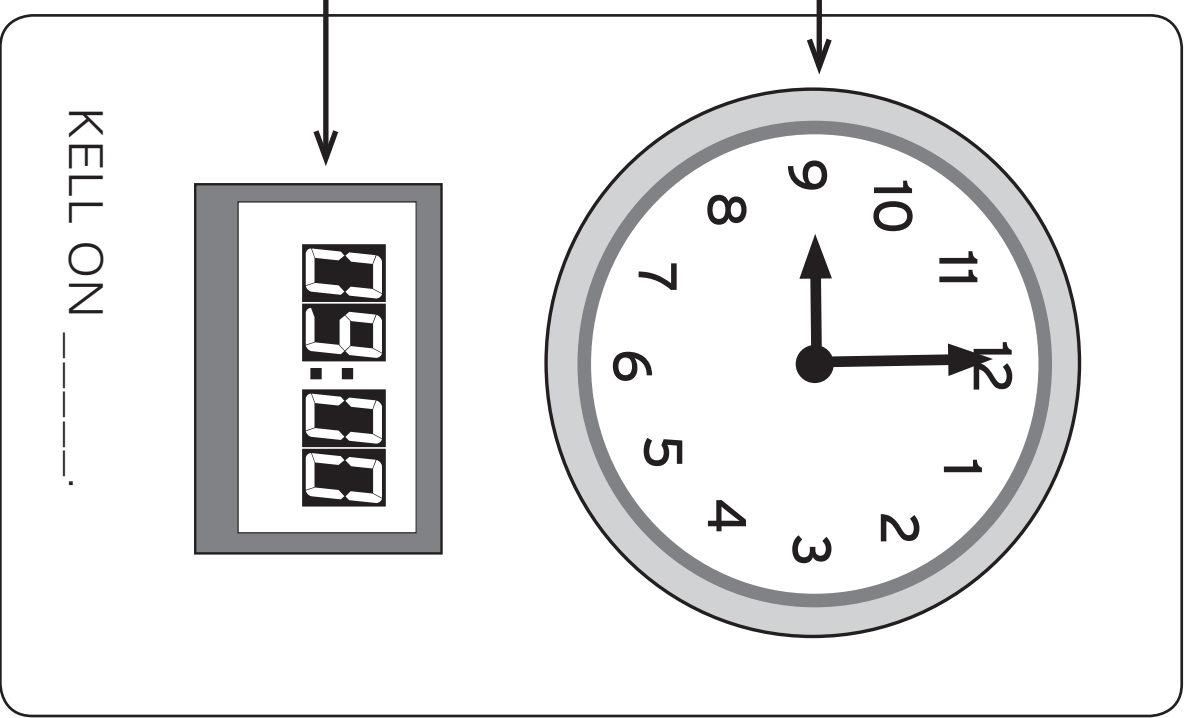

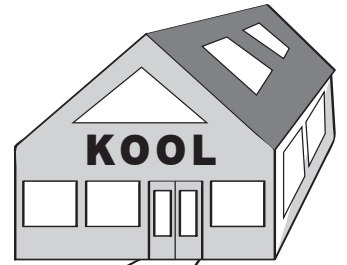
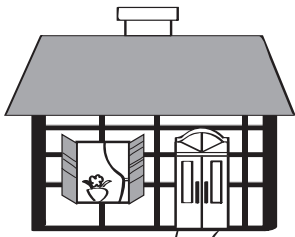

KOOLI-TEELE KULUB 1 TUND.

KELL ON \_\_\_\_\_.

KELL ON \_\_\_\_\_.

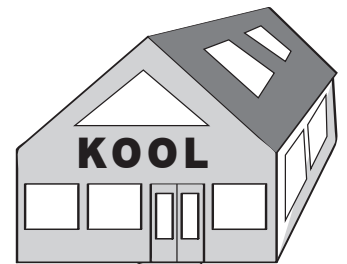

KOOLI-TEELE KULUB 1 TUND.

KELL ON \_\_\_\_\_.

KELL ON \_\_\_\_\_.

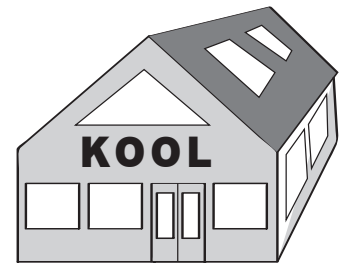

KOOLI-TEELE KULUB 1 TUND.

KELL ON \_\_\_\_\_.

KELL ON \_\_\_\_\_.

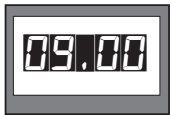
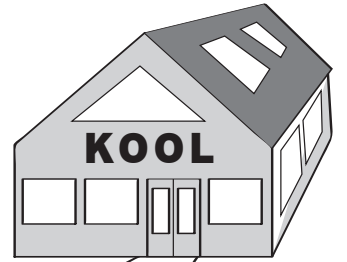
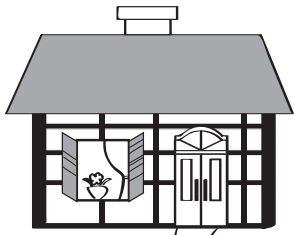

KOOLI-TEELE KULUB 1 TUND.

KELL ON \_\_\_\_\_.

KELL ON \_\_\_\_\_.

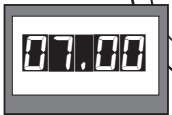
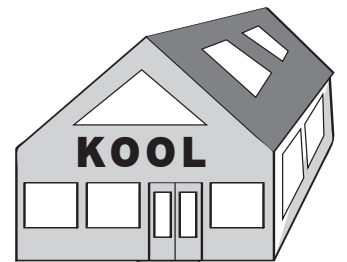

KOOLI-TEELE KULUB 1 TUND.

KELL ON \_\_\_\_\_.

KELL ON \_\_\_\_\_.

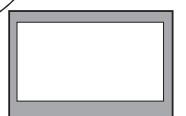
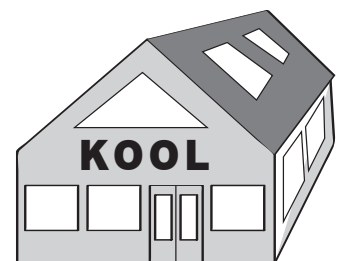

KOOLI-TEELE KULUB 1 TUND.

KELL ON \_\_\_\_\_.

KELL ON \_\_\_\_\_.

TUNNID ALGAVAD KELL \_\_\_\_\_.

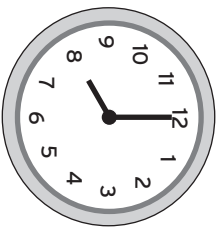
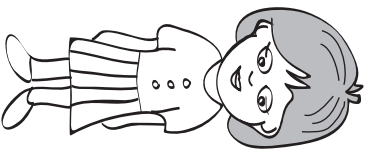

MARI JÕUDIS KOOLI KELL \_\_\_\_\_.

MARI HILINES / EI HILINENUD KOOLI.

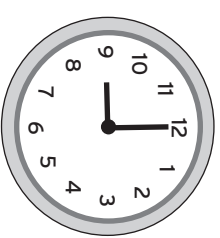
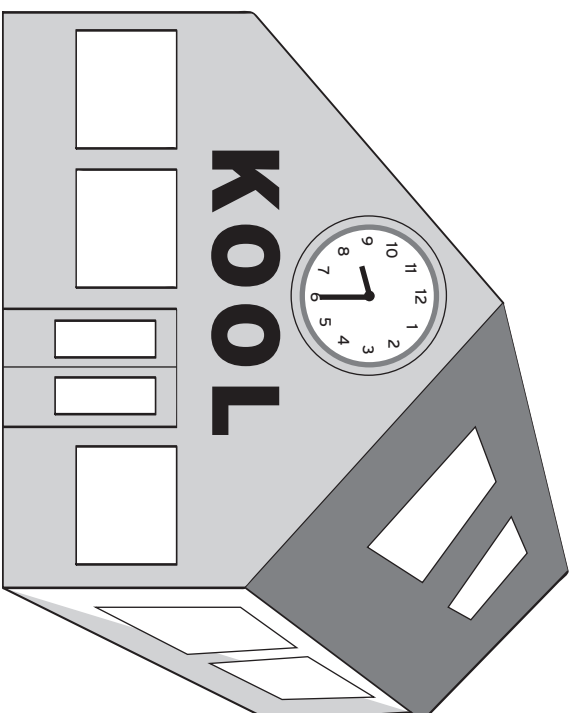

SIIRI JÕUDIS KOOLI KELL \_\_\_\_\_.

SIIRI HILINES / EI HILINENUD KOOLI.

TUNNID ALGAVAD KELL \_\_\_\_\_.

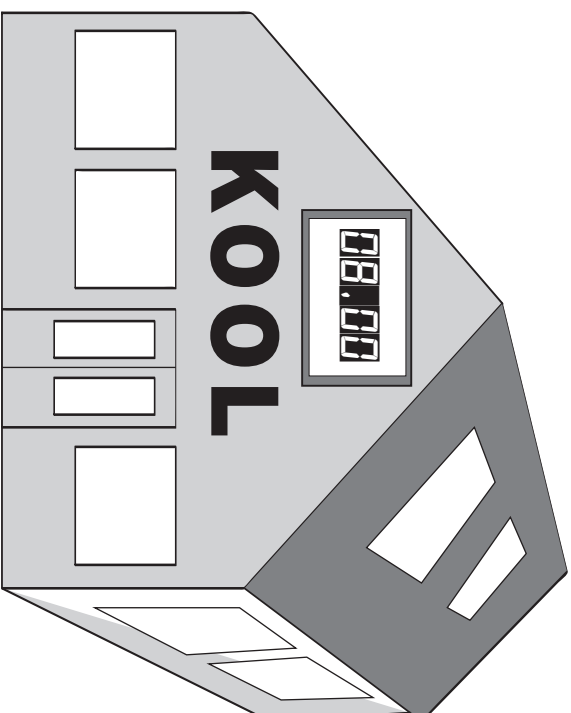

MARI JÕUDIS KOOLI KELL \_\_\_\_\_.

MARI HILINES / EI HILINENUD KOOLI.



SIIRI JÕUDIS KOOLI KELL \_\_\_\_\_.

SIIRI HILINES / EI HILINENUD KOOLI.



BUSS VÄLJUB KELL \_\_\_\_\_.

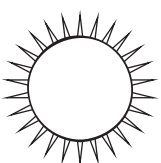

KALLE

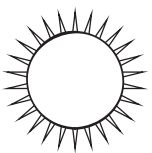
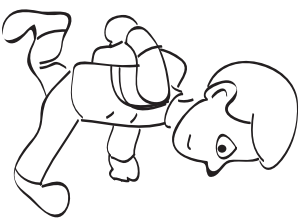

KELL ON \_\_\_\_\_.

TANEL

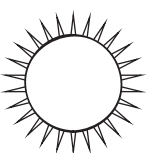
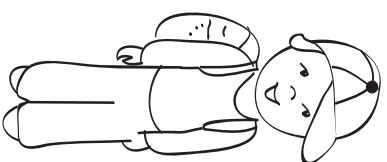

KELL ON \_\_\_\_\_.

TIIU

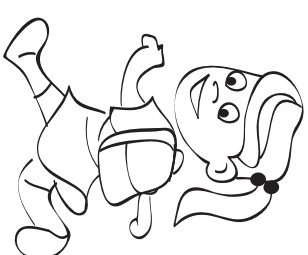

KELL ON \_\_\_\_\_.

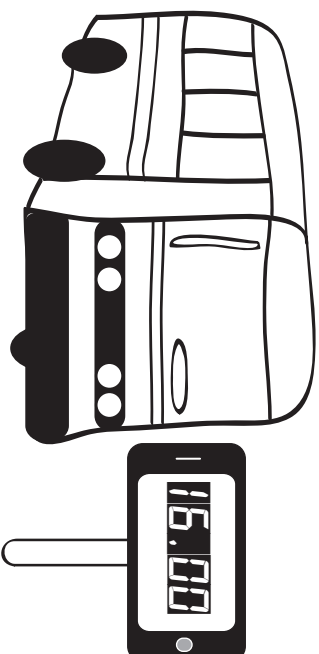

BUSS VÄLJUB KELL \_\_\_\_\_.

ANDRES

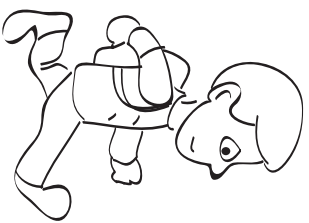

KELL ON \_\_\_\_\_.

ANNI



KELL ON \_\_\_\_\_.

MEEELIS

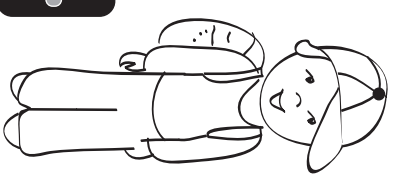

KELL ON \_\_\_\_\_.

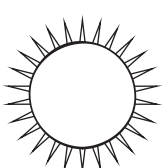
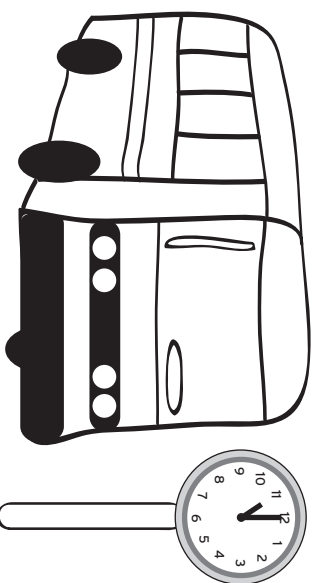

BUSS VÄLJUB KELL \_\_\_\_\_.

MART

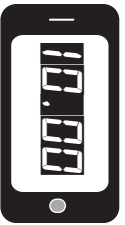

KELL ON \_\_\_\_\_.

TEELE



KELL ON \_\_\_\_\_.

SIIM

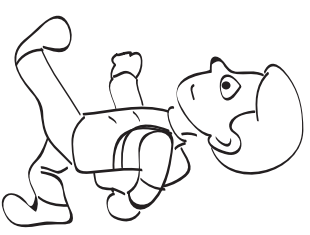

KELL ON \_\_\_\_\_.

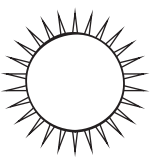



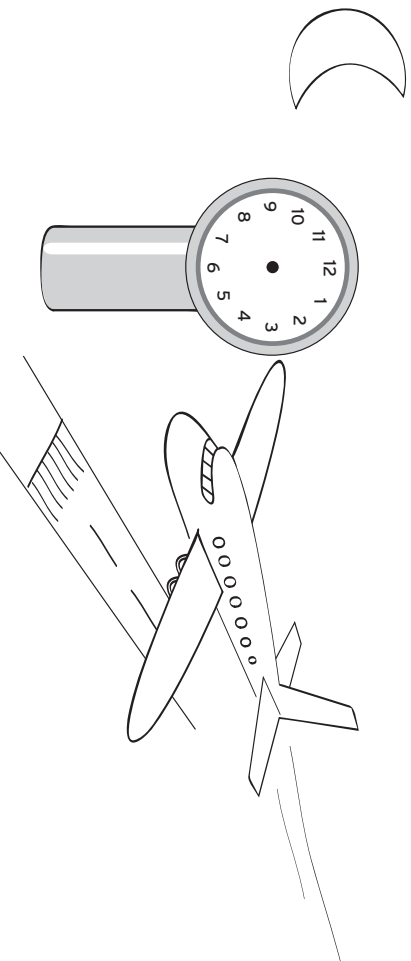

LENNUK VÄLJUB KELL 3.

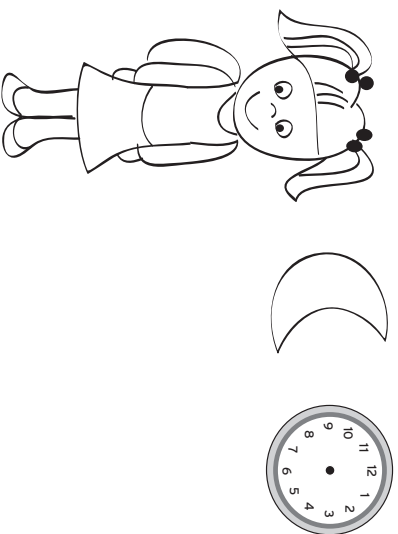

PIIA KELL ON 2.

PIIA JÕUAB / EI JÕUA LENNUKILE.

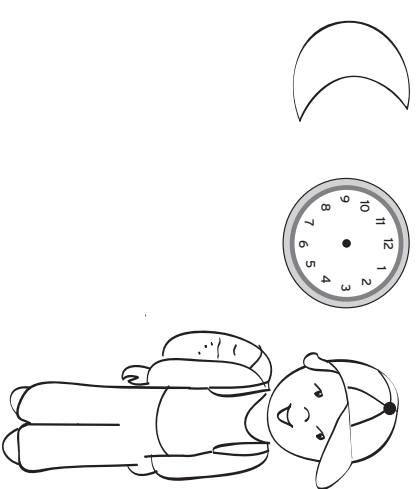

TAAVI KELL ON POOL 4.

TAAVI JÕUAB / EI JÕUA LENNUKILE.

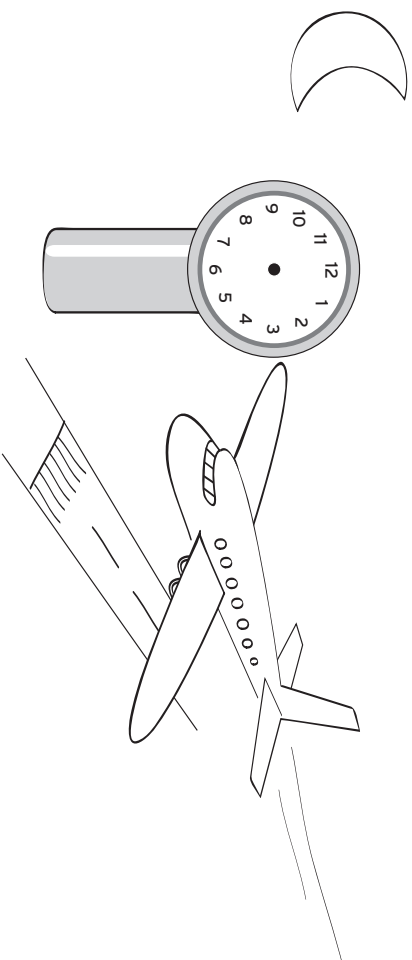

LENNUK VÄLJUB KELL 1.

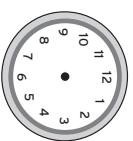
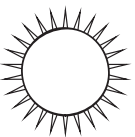
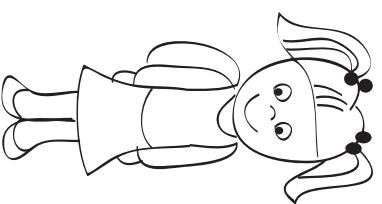

PIIA KELL ON 1.

PIIA JÕUAB / EI JÕUA LENNUKILE.

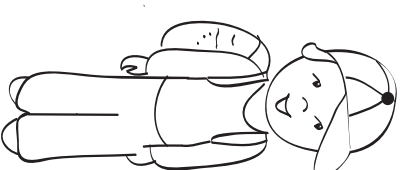
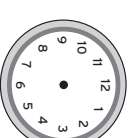

TAAVI KELL ON 1.

TAAVI JÕUAB / EI JÕUA LENNUKILE.

13.30	16.00	16.30	16.30	17.00	17.30
-------	-------	-------	-------	-------	-------

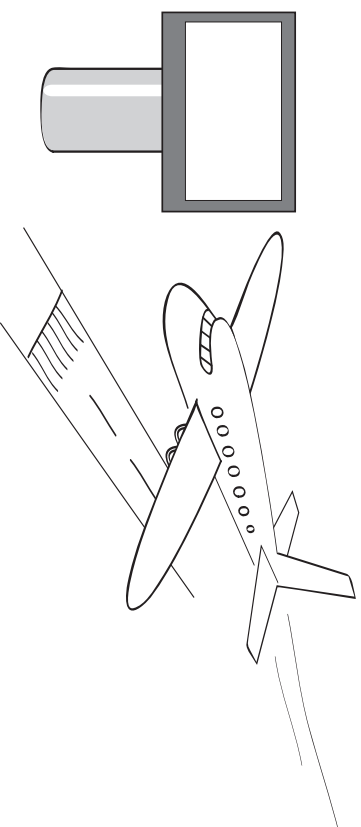

LENNUK VÄLJUB KELL 16.30.

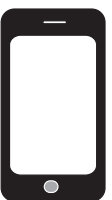
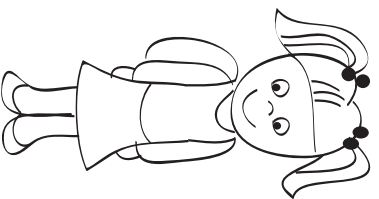

PIIA KELL ON 16.30.

TAAVI KELL ON 16.

PIIA JÕUAB / EI JÕUA LENNUKILE.

TAAVI JÕUAB / EI JÕUA LENNUKILE.

07.00	07.30	08.00	08.00	08.30	19.00	19.30	20.00	20.00
-------	-------	-------	-------	-------	-------	-------	-------	-------

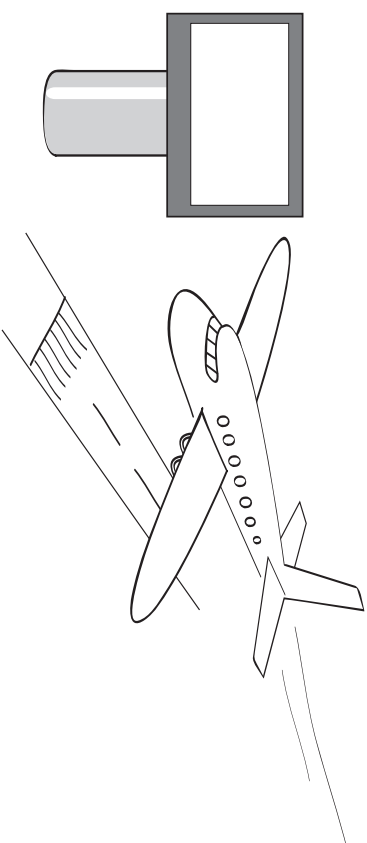

LENNUK VÄLJUB KELL 8 HOMMIKUL.

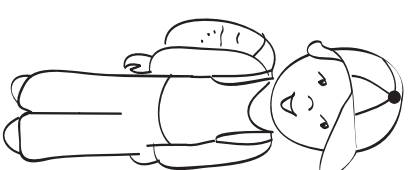
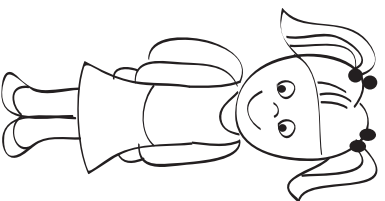

PIIA KELL ON 8 ÖHTUL.

TAAVI KELL ON 8 HOMMIKUL.

PIIA JÕUAB / EI JÕUA LENNUKILE.

TAAVI JÕUAB / EI JÕUA LENNUKILE.

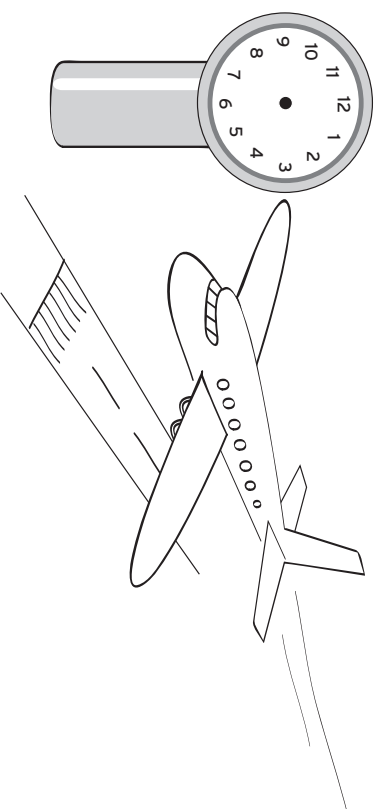

LENNUK VÄLJUB KELL POOL 3 HOMMIKUL.

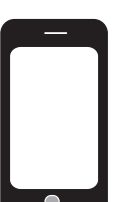
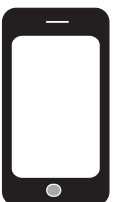
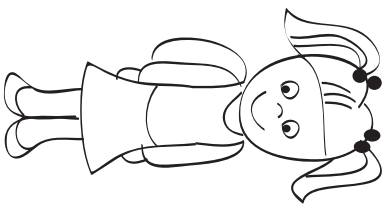

01.30	02.30	03.30	04.30
-------	-------	-------	-------

PIIA KELL ON POOL 4 HOMMIKUL.

TAAVI KELL ON 02.30.

PIIA JÕUAB / EI JÕUA LENNUKILE.

TAAVI JÕUAB / EI JÕUA LENNUKILE.

MIIA

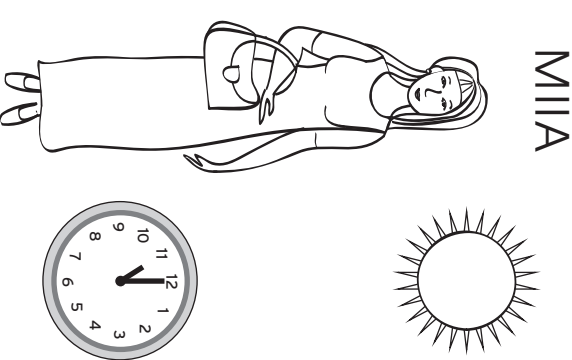

KELL ON \_\_\_\_\_.

PILLE

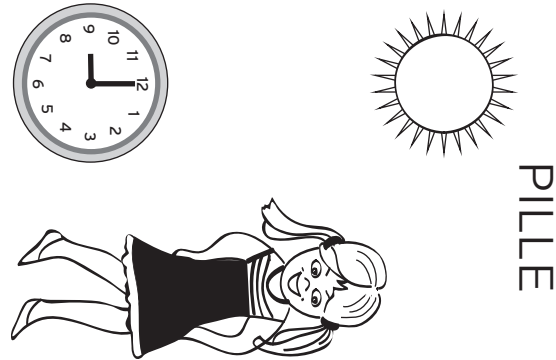

KELL ON \_\_\_\_\_.

KEVIN

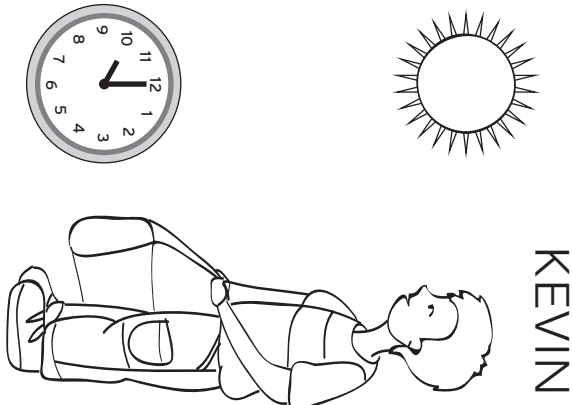

KELL ON \_\_\_\_\_.

ESIMESENA JÕUDIS LAEVALE \_\_\_\_\_

TEISENA JÕUDIS LAEVALE \_\_\_\_\_

KOLMANDANA JÕUDIS LAEVALE \_\_\_\_\_

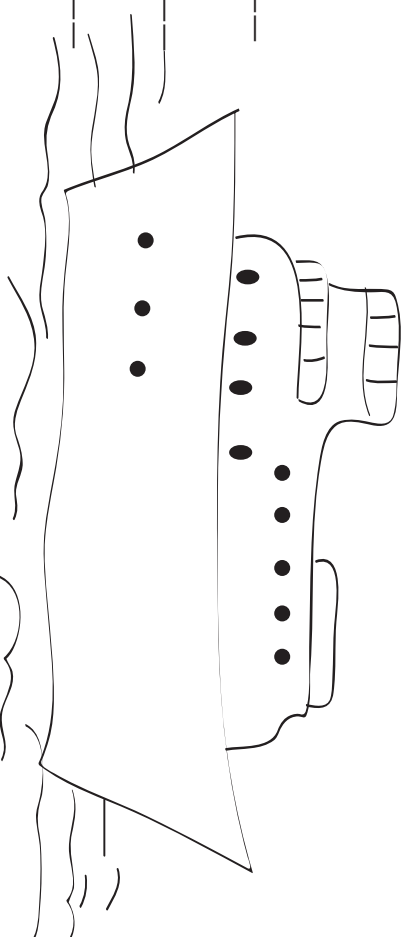

MIIA



KELL ON \_\_\_\_\_.

PILLE



KELL ON \_\_\_\_\_.

KEVIN

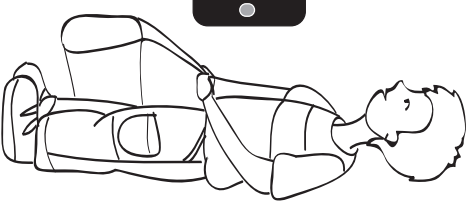

KELL ON \_\_\_\_\_.

ESIMESENA JÕUDIS LAEVALE \_\_\_\_\_

TEISENA JÕUDIS LAEVALE \_\_\_\_\_

KOLMANDANA JÕUDIS LAEVALE \_\_\_\_\_

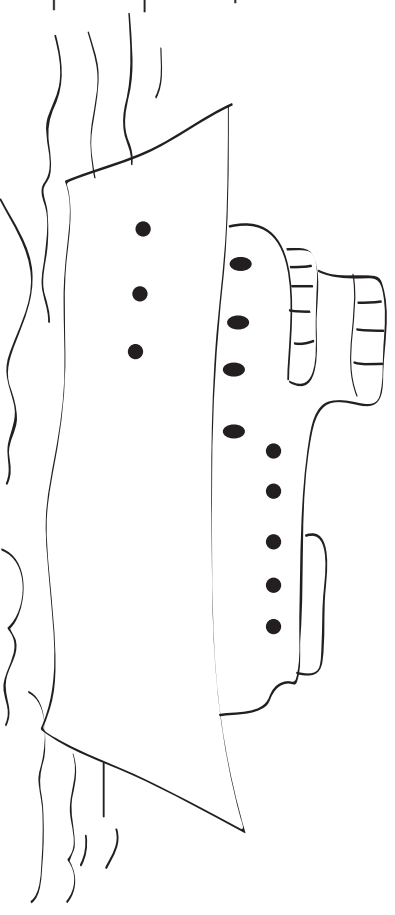

**Signe Leht**  
**MATEMAATIKA IV**  
**Kaal. Raha. Kell**  
Töölehtede komplekt

II trükk

Õppevara vastab põhikooli riikliku lihtsustatud õppekava toimetulekuõppele II ja III arengutasemel.

Retsenseerinud Viivi Neare ja Ragne Kuusk  
Töölehed joonistanud, küljendanud ja toimetanud Ivi Piibeleht, OÜ Kirjavalla

„Matemaatika IV. Kaal. Raha. Kell“ töölehtede komplekti juurde kuuluv õpetaja juhendmaterjal on kättesaadav portaalist **hev.edu.ee**

Raamatu väljaandmist on toetanud Euroopa Sotsiaalfond ja Eesti riik programmi „Hariduslike erivajadustega õpilaste õppevara arendamine“ kaudu. Programmi viib ellu Sihtasutus Innove.

Kõik õigused kaitstud. Igasugune autoriõigusega kaitstud materjali ebaseaduslik paljundamine ja levitamine toob kaasa seaduses ette nähtud vastutuse.

Autoriõigus: Sihtasutus Innove, 2014

ISBN 978-9949-524-18-1 (trükis)  
ISBN 978-9949-524-19-8 (pdf)  
ISBN 978-9949-524-20-4 (pdf, õpetajamaterjal)



Euroopa Liit  
Euroopa Sotsiaalfond



Eesti tuleviku heaks



Hariduslike erivajadustega  
õpilaste õppevara arendamine

