



ISSN 1406-376X

EESTI VABARIIK

T **EESTI**
TÖÖSTUSDISAINI-
LAHENDUSE LEHT



PATENDIAMETI AMETLIK VÄLJAANNE

2
2006
TALLINN



ISSN 1406-376X

EESTI VABARIIK

T **EESTI**
TÖÖSTUSDISAINI-
LAHENDUSE LEHT

**PATENDIAMETI
AMETLIK VÄLJAANNE**

IX aastakäik

**Käesolevas numbris
esitatud andmed
loetakse avaldatuks
15. mail 2006. a.**

2
2006
MAI
TALLINN

Eesti Tööstusdisainilahenduse Lehte antakse välja tööstusdisaini kaitse seaduse (jõustunud 11.01.1998) alusel.
The Estonian Industrial Design Gazette is the official publication of the Estonian Patent Office.
Published under Industrial Design Protection Law of the Republic of Estonia (coming into force 11 January 1998).
Date of publication of the data presented in this issue - 15 May 2006.

Patendiameti
infoosakond
Toompuiestee 7
15041 Tallinn
Tel 627 7907
Faks 627 7943
E-post Info@epa.ee

The Information Department
of the Estonian Patent Office
Toompuiestee 7
15041 Tallinn, ESTONIA
Phone +372 627 7907
Fax +372 627 7943
E-mail Info@epa.ee

Levitaja

Eesti Patendiraamatukogu
Olevimägi 8/10
10123 Tallinn
Tel 641 1248
Faks 641 1018
E-post patent@patentlib.ee

Distributor

Estonian Patent Library
Olevimägi 8/10
10123 Tallinn, ESTONIA
Phone +372 641 1248
Fax +372 641 1018
E-mail patent@patentlib.ee

SISUKORD

Andmete identifitseerimise rahvusvahelised numberkoodid (INID-koodid)	4
Riikide, teiste ühenduste ja valitsustevaheliste organisatsioonide koodid	5
I. REGISTREERITUD TÖÖSTUSDISAINILAHENDUSED	6
II. RAHVUSVAHELISELT REGISTREERITUD TÖÖSTUSDISAINILAHENDUSED	35
III. REGISTREERINGU KEHTIVUSE PIKENDAMINE	81
IV. TÖÖSTUSDISAINILAHENDUSE ÜLEMINEK	81
V. REGISTREERINGU JAGAMINE	-
VI. MUUD REGISTREERINGU ANDMETE MUUDATUSED	81
VII. REGISTREERINGU ANDMETE PARANDUSED	-
VIII. TÖÖSTUSDISAINILAHENDUSE LITSENTSIDE REGISTREERIMINE	-
IX. TÖÖSTUSDISAINILAHENDUSE PANTIDE REGISTREERIMINE	-
X. TUNNISTUSE DUPLIKAADI VÄLJAANDMINE	-
XI. TÖÖSTUSDISAINILAHENDUSE KUSTUTAMINE REGISTRIST	81
XII. LOENDID	82
Registreeritud tööstusdisainilahenduste süstemaatiline loend	82
Registreeritud tööstusdisainilahenduste registreerimistaotluste numbriline loend	82
Avaldatud rahvusvahelise registreeringu registreerimise otsuse teadete numbriline loend	82
XIII. TÖÖSTUSDISAINIALASED ÕIGUSAKTID JA MUU INFO	83
Riiklikus patendivolinike registris registreeritud patendivolinike nimekiri	83

CONTENTS

Internationally Agreed Numbers for the Identification of Data (INID Codes)	4
List of Codes of States, Other Entities and Intergovernmental Organizations	5
I. REGISTERED INDUSTRIAL DESIGNS	6
II. INTERNATIONALLY REGISTERED INDUSTRIAL DESIGNS	35
III. EXTENSION OF THE REGISTRATION	81
IV. TRANSFER OF INDUSTRIAL DESIGN	81
V. DIVISION OF THE REGISTRATION.	-
VI. OTHER AMENDMENTS TO REGISTRATION DATA	81
VII. CORRECTIONS TO REGISTRATION DATA	-
VIII. REGISTERING OF LICENSES OF INDUSTRIAL DESIGN	-
IX. REGISTERING OF PLEDGES OF INDUSTRIAL DESIGN	-
X. ISSUE OF A COPY OF THE INDUSTRIAL DESIGN CERTIFICATE	-
XI. DELETION OF INDUSTRIAL DESIGN FROM THE REGISTER	81
XII. LISTS	82
Systematic List of Registered Industrial Designs	82
Numerical List of Registration Applications of Registered Industrial Designs	82
Numerical List of Published Notices of Decisions on Registration of the International Registration	82
XIII. LEGAL ACTS AND INFORMATION CONCERNING INDUSTRIAL DESIGNS	83
List of Patent Attorneys, Registered in the Estonian State Register of Patent Attorneys	87

**ANDMETE IDENTIFITSEERIMISE
RAHVUSVAHELISED NUMBERKOODID
(INID-KOODID)
WIPO Standard ST. 80**

**INTERNATIONALLY AGREED NUMBERS FOR
THE IDENTIFICATION OF DATA
(INID CODES)
WIPO Standard ST. 80**

(11) Registreeringu number	(11) Number of the Registration
(15) Registreerimise kuupäev	(15) Date of the Registration
(18) Registreeringu kehtivuse lõppemise kuupäev	(18) Expected expiration date of the registration
(21) Registreerimistaotluse number	(21) Application Number
(22) Registreerimistaotluse esitamise kuupäev	(22) Application Filing Date
(24) Registreeringu kehtivuse alguse kuupäev	(24) Date from which the Industrial Design right has effected
(28) Variantide arv	(28) Number of Industrial Designs included in the application
(30) Prioriteet	(30) Priority
(51) Rahvusvahelise klassifikatsiooni klassi ja alaklassi number	(51) International Classification for Industrial Designs (class and subclass of the Locarno Classification)
(54) Tööstusdisainilahenduse nimetus	(54) Title of the Industrial Design
(55) Tööstusdisainilahenduse reproduktsioon	(55) Reproduction of the Industrial Design
(72) Tööstusdisainilahenduse autor(id)	(72) Author(s) of Industrial Design
(73) Tööstusdisainilahenduse omanik(ud)	(73) Proprietor(s) of Industrial Design
(74) Patendivolinik või ühine esindaja	(74) Patent Attorney or Common Representative

**RIIKIDE, TEISTE ÜHENDUSTE JA VALITSUSTEVAAHELISTE
ORGANISATSIOONIDE KOODID**

AD	Andorra	DO	Dominikaani	IT	Itaalia	PT	Portugal
AE	Araabia		Vabariik	JM	Jamaica	PW	Belau
	Ühendemiraadid	DZ	Alžeeria	JO	Jordania	PY	Paraguay
AF	Afganistan	EA	Euraasia	JP	Jaapan	QA	Katar
AG	Antigua ja Barbuda		Patendiorganisat-	KE	Kenya	RO	Rumeenia
AI	Anguilla		sioon (EAPO)	KG	Kõrgõzstan	RU	Venemaa
AL	Albaania	EC	Ecuador	KH	Kambodža	RW	Rwanda
AM	Armeenia	EE	Eesti	KI	Kiribati	SA	Saudi Araabia
AN	Hollandi Antillid	EG	Egiptus	KM	Komoorid	SB	Salomoni Saared
AO	Angola	EH	Lääne-Sahara	KN	Saint Kitts ja Nevis	SC	Seišellid
AP	Aafrika Regionaalne	EM	Siseturu	KP	Põhja-Korea	SD	Sudaan
	Tööstusomandi Orga-		Ühtlustamise	KR	Lõuna-Korea	SE	Rootsi
	nisatsioon (ARIPO)		Amet (kaubamärgid	KW	Kuveit	SG	Singapur
AR	Argentina		ja tööstusdisaini-	KY	Kaimanisaared	SH	Saint Helena
AS	Ameerika Samoa		lahendused)(OHIM)	KZ	Kasahstan	SI	Sloveenia
AT	Austria	EP	Euroopa	LA	Laos	SK	Slovakkia
AU	Austraalia		Patendiamet (EPO)	LB	Liibanon	SL	Sierra Leone
AW	Aruba	ER	Eritrea	LC	Saint Lucia	SM	San Marino
AZ	Aserbaidžaan	ES	Hispaania	LI	Liechtenstein	SN	Senegal
BA	Bosnia ja	ET	Etiopia	LK	Sri Lanka	SO	Somaalia
	Hertsegoviina	FI	Soome	LR	Libeeria	SR	Suriname
BB	Barbados	FJ	Fidži	LS	Lesotho	ST	São Tomé ja Príncipe
BD	Bangladesh	FK	Falklandi (Malviini)	LT	Leedu	SV	El Salvador
BE	Belgia		saared	LU	Luksemburg	SY	Süüria
BF	Burkina Faso	FM	Mikroneesia	LV	Läti	SZ	Svaasimaa
BG	Bulgaaria	FO	Fääri saared	LY	Liibüa	TC	Turks ja Caicos
BH	Bahrein	FR	Prantsusmaa	MA	Maroko	TD	Tšaad
BI	Burundi	GA	Gabon	MC	Monaco	TG	Togo
BJ	Benin	GB	Ühendkuningriik	MD	Moldova	TH	Tai
BM	Bermuda		(Suurbritannia)	MG	Madagaskar	TJ	Tadžikistan
BN	Brunei	GC	Pärsia Lahe	MH	Marshalli Saared	TM	Türkmenistan
BO	Boliivia		Koostöönõukogu	MK	Makedoonia	TN	Tuneesia
BR	Brasiilia	GD	Grenada	ML	Mali	TO	Tonga
BS	Bahama	GE	Gruusia	MM	Myanmar (Birma)	TL	Ida-Timor
BT	Bhutan	GH	Ghana	MN	Mongoolia	TR	Türgi
BV	Bouvet' saar	GI	Gibraltar	MO	Macao	TT	Trinidad ja Tobago
BW	Botswana	GL	Gröönimaa	MP	Põhja-Mariaanid	TV	Tuvalu
BX	Beneluxi	GM	Gambia	MR	Mauritaania	TW	Taiwan (Hiina provints)
	Kaubamärgiamet	GN	Guinea	MS	Montserrat	TZ	Tansaania
	(BBM) ja Beneluxi	GQ	Ekvatoriaal-Guinea	MT	Malta	UA	Ukraina
	Tööstusdisainilahen-	GR	Kreeka	MU	Mauritius	UG	Uganda
	duste Amet (BBDM)	GS	Lõuna-Georgia ja	MV	Maldiivid	US	Ameerika
BY	Valgevene		Lõuna-Sandwichi	MW	Malawi		Ühendriigid
BZ	Belize		saared	MX	Mehhiko	UY	Uruguay
CA	Kanada	GT	Guatemala	MY	Malaisia	UZ	Usbekistan
CF	Kesk-Aafrika	GW	Guinea-Bissau	MZ	Mosambiik	VA	Vatikan (Püha Tool)
	Vabariik	GY	Guyana	NA	Namiibia	VC	Saint Vincent ja
CG	Kongo	HK	Hongkong	NE	Niger		Grenadiinid
CH	Šveits	HN	Honduras	NG	Nigeeria	VE	Venezuela
CI	Côte d'Ivoire	HR	Horvaatia	NI	Nicaragua	VG	Neitsisaared
CK	Cooki saared	HT	Haiti	NL	Holland	VN	Vietnam
CL	Tšiili	HU	Ungari	NO	Norra	VU	Vanuatu
CM	Kamerun	IB	Ülemaailmse	NP	Nepal	WO	Ülemaailmne
CN	Hiina		Intellektuaalomandi	NR	Nauru		Intellektuaalomandi
CO	Kolumbia		Organisatsiooni	NZ	Uus-Meremaa		Organisatsioon
CR	Costa Rica		(WIPO) Rahvus-	OA	Aafrika Intellektuaal-		(WIPO) (Rahvus-
CS	Serbia ja Montenegro		vaheline Büroo		omandi Organisat-		vaheline Büroo)
CU	Kuuba	ID	Indoneesia		sioon (OAPI)	WS	Samoa
CV	Cabo Verde	IE	Iiri	OM	Omaan	YE	Jeemen
CY	Küpros	IL	Iisrael	PA	Panama	ZA	Lõuna-Aafrika Vabariik
CZ	Tšehhi	IM	Man'i saar	PE	Peruu	ZM	Sambia
DE	Saksamaa	IN	India	PG	Paapua Uus-Guinea	ZR	Zaire
DJ	Djibouti	IQ	Iraak	PH	Filipiinid	ZW	Zimbabwe
DK	Taani	IR	Iraan	PK	Pakistan		
DM	Dominica	IS	Island	PL	Poola		

I. REGISTREERITUD TÖÖSTUSDISAINILAHENDUSED

Avaldatakse "Tööstusdisaini kaitse seaduse" § 55¹ lõike 7 alusel.

Patendiamet ei ole kontrollinud tööstusdisainilahenduse uudsust ja eristatavust tulenevalt "Tööstusdisaini kaitse seaduse" § 31 lõike 2 punktist 1.

(11) Registreeringu number	01139	(51) Klass: 11-02
(21) Taotluse number	D200500056	
(15) Registreerimise päev	15.05.2006	
(22) Esitamise päev	22.07.2005	
(24) Registreeringu kehtivuse alguse päev	22.07.2005	
(18) Registreeringu kehtivuse lõppemise päev	22.07.2010	
(28) Variantide arv	6	
(72) Autor	Tatjana Zolotukhina, Veeru 22-45, 74113 Maardu, Harju maakond, EE	
(73) Omanik	Tatjana Zolotukhina, Veeru 22-45, 74113 Maardu, Harju maakond, EE	
(74) Patendivolinik või ühine esindaja	Lembit Kalev	

(54) Nimetus **Keraamiline suveniir**

(55) Reproduktsoon

01139-01



01139-02



01139-03



01139-04



01139-05



01139-06



- (11) **Registreeringu number** **01140** (51) **Klass:** **11-02**
- (21) **Taotluse number** D200500056A
- (15) **Registreerimise päev** 15.05.2006
- (22) **Esitamise päev** 22.07.2005
- (24) **Registreeringu kehtivuse alguse päev** 22.07.2005
- (18) **Registreeringu kehtivuse lõppemise päev** 22.07.2010
- (28) **Variantide arv** 2
- (72) **Autor** Tatjana Zolotukhina, Veeru 22-45, 74113 Maardu, Harju maakond, EE
- (73) **Omanik** Tatjana Zolotukhina, Veeru 22-45, 74113 Maardu, Harju maakond, EE
- (74) **Patendivolinik või ühine esindaja** Lembit Kalev
- (54) **Nimetus** **Keraamiline suveniir**
- (55) **Reproduktsoon**

01140-01



01140-02



(11) Registreeringu number **01141**

(51) Klass: **11-02**

(21) Taotluse number D200500056B

(15) Registreerimise päev 15.05.2006

(22) Esitamise päev 22.07.2005

(24) Registreeringu kehtivuse alguse päev 22.07.2005

(18) Registreeringu kehtivuse lõppemise päev 22.07.2010

(28) Variantide arv 3

(72) Autor Tatjana Zolotukhina, Veeru 22-45, 74113 Maardu, Harju maakond, EE

(73) Omanik Tatjana Zolotukhina, Veeru 22-45, 74113 Maardu, Harju maakond, EE

(74) Patendivolinik või ühine esindaja Lembit Kalev

(54) Nimetus **Keraamiline suveniir**

(55) Reproduktsoon

01141-01



01141-02



01141-03



(11) Registreeringu number	01142	(51) Klass: 11-02
(21) Taotluse number	D200500056C	
(15) Registreerimise päev	15.05.2006	
(22) Esitamise päev	22.07.2005	
(24) Registreeringu kehtivuse alguse päev	22.07.2005	
(18) Registreeringu kehtivuse lõppemise päev	22.07.2010	
(28) Variantide arv	2	
(72) Autor	Tatjana Zolotukhina, Veeru 22-45, 74113 Maardu, Harju maakond, EE	
(73) Omanik	Tatjana Zolotukhina, Veeru 22-45, 74113 Maardu, Harju maakond, EE	
(74) Patendivolinik või ühine esindaja	Lembit Kalev	

(54) Nimetus **Keraamiline suveniir**

(55) Reproduktsoon

01142-01



01142-02



(11) Registreeringu number	01143	(51) Klass: 11-02
(21) Taotluse number	D200500056D	
(15) Registreerimise päev	15.05.2006	
(22) Esitamise päev	22.07.2005	
(24) Registreeringu kehtivuse alguse päev	22.07.2005	
(18) Registreeringu kehtivuse lõppemise päev	22.07.2010	
(28) Variantide arv	1	
(72) Autor	Tatjana Zolotukhina, Veeru 22-45, 74113 Maardu, Harju maakond, EE	
(73) Omanik	Tatjana Zolotukhina, Veeru 22-45, 74113 Maardu, Harju maakond, EE	
(74) Patendivolinik või ühine esindaja	Lembit Kalev	

(54) Nimetus **Keraamiline suveniir**

(55) Reproduktsoon

01143-01



(11) Registreeringu number	01144	(51) Klass: 11-02
(21) Taotluse number	D200500056F	
(15) Registreerimise päev	15.05.2006	
(22) Esitamise päev	22.07.2005	
(24) Registreeringu kehtivuse alguse päev	22.07.2005	
(18) Registreeringu kehtivuse lõppemise päev	22.07.2010	
(28) Variantide arv	1	
(72) Autor	Tatjana Zolotukhina, Veeru 22-45, 74113 Maardu, Harju maakond, EE	
(73) Omanik	Tatjana Zolotukhina, Veeru 22-45, 74113 Maardu, Harju maakond, EE	
(74) Patendivolinik või ühine esindaja	Lembit Kalev	

(54) Nimetus **Keraamiline suveniir**

(55) Reproduktsoon

01144-01



(11) Registreeringu number	01145	(51) Klass: 11-02
(21) Taotluse number	D200500056G	
(15) Registreerimise päev	15.05.2006	
(22) Esitamise päev	22.07.2005	
(24) Registreeringu kehtivuse alguse päev	22.07.2005	
(18) Registreeringu kehtivuse lõppemise päev	22.07.2010	
(28) Variantide arv	1	
(72) Autor	Tatjana Zolotukhina, Veeru 22-45, 74113 Maardu, Harju maakond, EE	
(73) Omanik	Tatjana Zolotukhina, Veeru 22-45, 74113 Maardu, Harju maakond, EE	
(74) Patendivolinik või ühine esindaja	Lembit Kalev	

(54) Nimetus **Keraamiline suveniir**

(55) Reproduktsoon

01145-01



(11) Registreeringu number	01146	(51) Klass: 11-02
(21) Taotluse number	D200500056H	
(15) Registreerimise päev	15.05.2006	
(22) Esitamise päev	22.07.2005	
(24) Registreeringu kehtivuse alguse päev	22.07.2005	
(18) Registreeringu kehtivuse lõppemise päev	22.07.2010	
(28) Variantide arv	1	
(72) Autor	Tatjana Zolotukhina, Veeru 22-45, 74113 Maardu, Harju maakond, EE	
(73) Omanik	Tatjana Zolotukhina, Veeru 22-45, 74113 Maardu, Harju maakond, EE	
(74) Patendivolinik või ühine esindaja	Lembit Kalev	

(54) Nimetus **Keraamiline suveniir**

(55) Reproduktsoon

01146-01



- (11) **Registreeringu number** **01147**
- (21) **Taotluse number** D200500056I
- (15) **Registreerimise päev** 15.05.2006
- (22) **Esitamise päev** 22.07.2005
- (24) **Registreeringu kehtivuse alguse päev** 22.07.2005
- (18) **Registreeringu kehtivuse lõppemise päev** 22.07.2010
- (28) **Variantide arv** 1
- (72) **Autor** Tatjana Zolotukhina, Veeru 22-45, 74113 Maardu, Harju maakond, EE
- (73) **Omanik** Tatjana Zolotukhina, Veeru 22-45, 74113 Maardu, Harju maakond, EE
- (74) **Patendivolinik või ühine esindaja** Lembit Kalev

(51) Klass: **11-02**

(54) **Nimetus** **Keraamiline suveniir**

(55) **Reproduktsoon**

01147-01



(11) Registreeringu number	01148	(51) Klass: 11-02
(21) Taotluse number	D200500056J	
(15) Registreerimise päev	15.05.2006	
(22) Esitamise päev	22.07.2005	
(24) Registreeringu kehtivuse alguse päev	22.07.2005	
(18) Registreeringu kehtivuse lõppemise päev	22.07.2010	
(28) Variantide arv	1	
(72) Autor	Tatjana Zolotukhina, Veeru 22-45, 74113 Maardu, Harju maakond, EE	
(73) Omanik	Tatjana Zolotukhina, Veeru 22-45, 74113 Maardu, Harju maakond, EE	
(74) Patendivolinik või ühine esindaja	Lembit Kalev	

(54) Nimetus **Keraamiline suveniir**

(55) Reproduktsoon

01148-01



- (11) **Registreeringu number** **01149** (51) Klass: **14-01, 14-02, 23-03, 25-01**
- (21) **Taotluse number** D200500090
- (15) **Registreerimise päev** 15.05.2006
- (22) **Esitamise päev** 16.12.2005
- (24) **Registreeringu kehtivuse alguse päev** 16.12.2005
- (18) **Registreeringu kehtivuse lõppemise päev** 16.12.2010
- (28) **Variantide arv** 1
- (72) **Autor** Eero Kotli, Viru 14-10, 10140 Tallinn, EE
- (73) **Omanik** Eero Kotli, Viru 14-10, 10140 Tallinn, EE
- (74) **Patendivolinik või ühine esindaja** Ott Moorlat

(54) **Nimetus** **Seinapaneel virtuaaltule- ja infrapunaseadmega**

(55) **Reproduktsoon**

01149-01

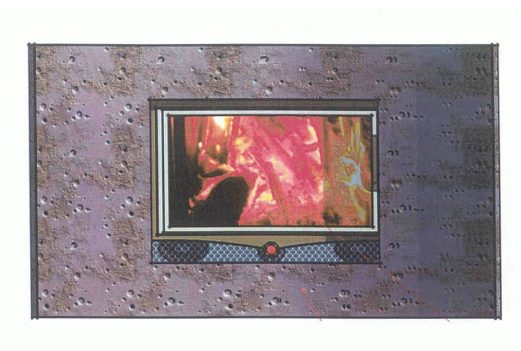
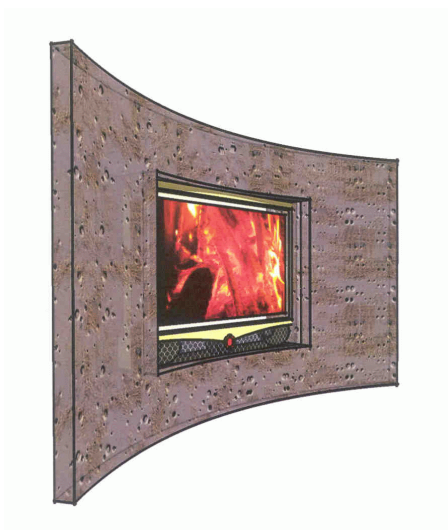

(11) Registreeringu number	01150	(51) Klass: 14-01, 14-02, 14-03, 23-03
(21) Taotluse number	D200500091	
(15) Registreerimise päev	15.05.2006	
(22) Esitamise päev	16.12.2005	
(24) Registreeringu kehtivuse alguse päev	16.12.2005	
(18) Registreeringu kehtivuse lõppemise päev	16.12.2010	
(28) Variantide arv	2	
(72) Autor	Eero Kotli, Viru 14-10, 10140 Tallinn, EE	
(73) Omanik	Eero Kotli, Viru 14-10, 10140 Tallinn, EE	
(74) Patendivolinik või ühine esindaja	Ott Moorlat	

(54) Nimetus **Ekraan salvestusseadmega ja infrapunakiirguriga virtuaaltule jaoks**

(55) Reproduktsoon

01150-01



01150-02

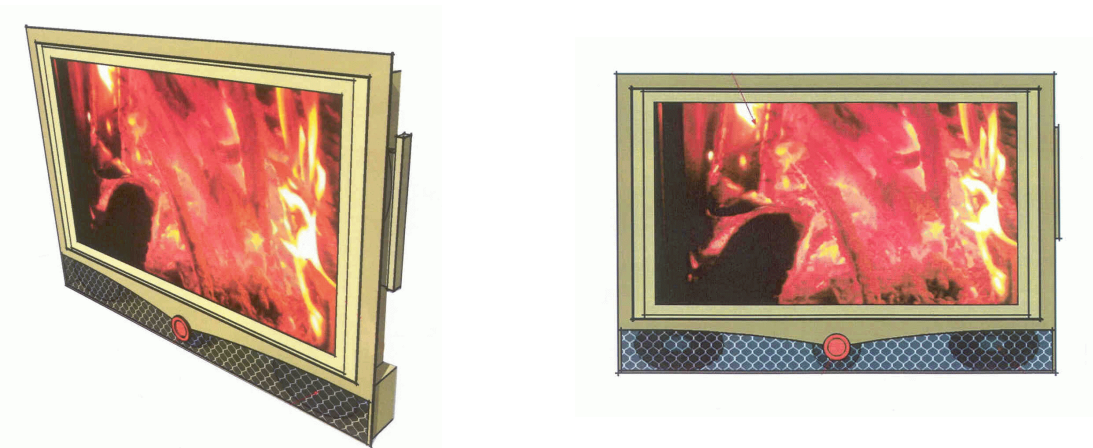

- (11) **Registreeringu number** **01151**
- (21) **Taotluse number** D200500092
- (15) **Registreerimise päev** 15.05.2006
- (22) **Esitamise päev** 16.12.2005
- (24) **Registreeringu kehtivuse alguse päev** 16.12.2005
- (18) **Registreeringu kehtivuse lõppemise päev** 16.12.2010
- (28) **Variantide arv** 1
- (72) **Autor** Eero Kotli, Viru 14-10, 10140 Tallinn, EE
- (73) **Omanik** Eero Kotli, Viru 14-10, 10140 Tallinn, EE
- (74) **Patendivolinik või ühine esindaja** Ott Moorlat

(51) Klass: **07-08, 14-01, 23-03**

(54) **Nimetus** **Kamina ekraan virtuaaltule ja infrapunakiirguriga**

(55) **Reproduktsoon**

01151-01



(11) Registreeringu number	01152	(51) Klass: 06-03
(21) Taotluse number	D200600001	
(15) Registreerimise päev	15.05.2006	
(22) Esitamise päev	03.01.2006	
(24) Registreeringu kehtivuse alguse päev	03.01.2006	
(18) Registreeringu kehtivuse lõppemise päev	03.01.2011	
(28) Variantide arv	2	
(72) Autor	Martti Rõigas, Jaama 69b, 63308 Põlva, EE Lauri Torn, Jaama 69b, 63308 Põlva, EE	
(73) Omanik	Martti Rõigas, Jaama 69b, 63308 Põlva, EE Lauri Torn, Jaama 69b, 63308 Põlva, EE	

(54) Nimetus **Laud**

(55) Reproduktsoon

01152-01



01152-02

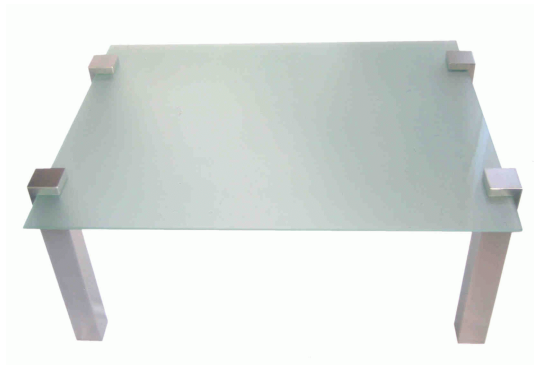

- (11) **Registreeringu number** **01153** (51) Klass: **09-02**
- (21) **Taotluse number** D200600003
- (15) **Registreerimise päev** 15.05.2006
- (22) **Esitamise päev** 18.01.2006
- (24) **Registreeringu kehtivuse alguse päev** 18.01.2006
- (18) **Registreeringu kehtivuse lõppemise päev** 18.01.2011
- (28) **Variantide arv** 2
- (30) **Prioriteediandmed** 2005502593, 08.09.2005, RU
- (72) **Autor** Alessandro Bologna, S. Lazzaro di Savena, Bologna, IT
- (73) **Omanik** OPEN JOINT STOCK COMPANY "OIL COMPANY "LUKOIL",
11, Sretensky boulevard, 101000 Moscow, RU
- (74) **Patendivolinik või ühine esindaja** Olga Treufeldt

(54) **Nimetus** **Kanister**

(55) **Reproduktsoon**

01153-01

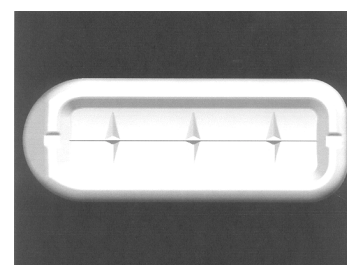
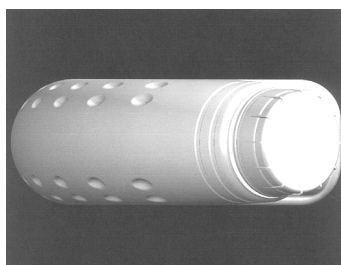
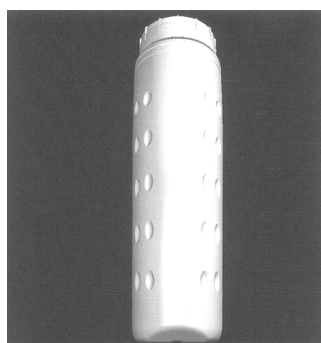
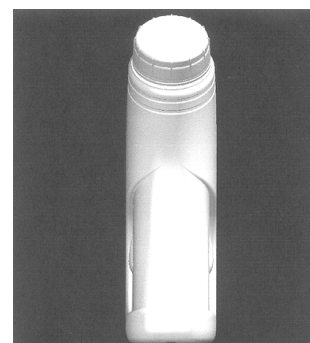
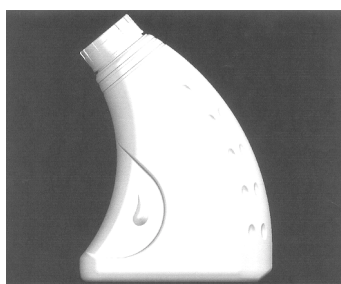
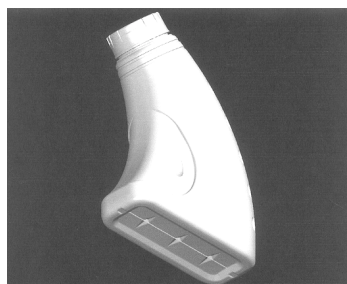

01153-02

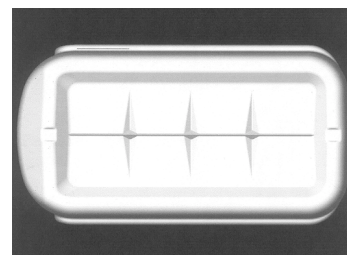
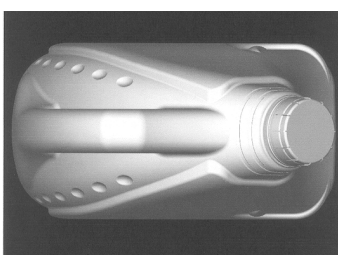
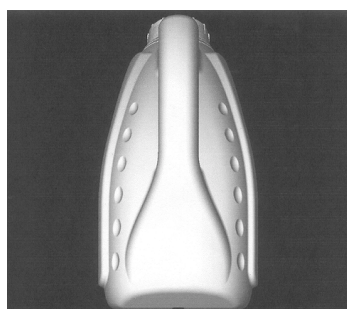
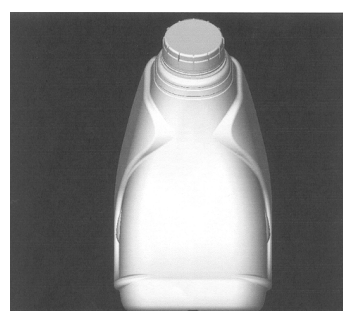
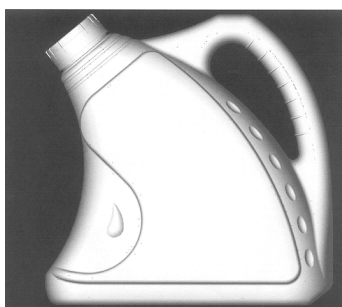
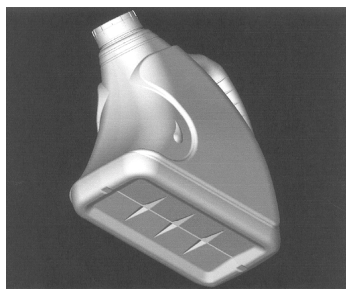

(11) Registreeringu number **01154**

(51) Klass: **06-03**

(21) Taotluse number D200600004

(15) Registreerimise päev 15.05.2006

(22) Esitamise päev 30.01.2006

(24) Registreeringu kehtivuse alguse päev 30.01.2006

(18) Registreeringu kehtivuse lõppemise päev 30.01.2011

(28) Variantide arv 4

(72) Autor Martin Laulik, Ranna tee 15, Käsmu küla, 45601 Lääne-Viru maakond, Vihula vald, EE

(73) Omanik Martin Laulik, Ranna tee 15, Käsmu küla, 45601 Lääne-Viru maakond, Vihula vald, EE

(54) Nimetus **Arvutilaud**

(55) Reproduktsioon

01154-01

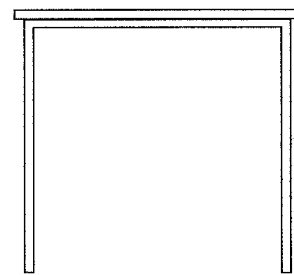
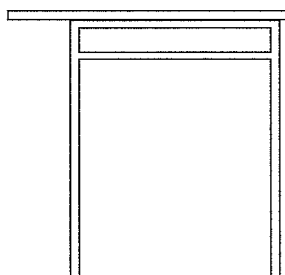
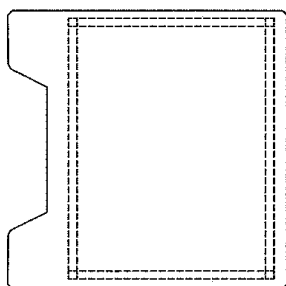

01154-02

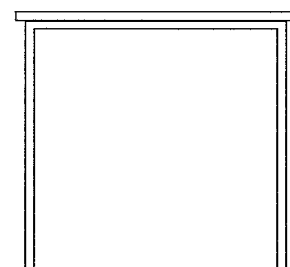
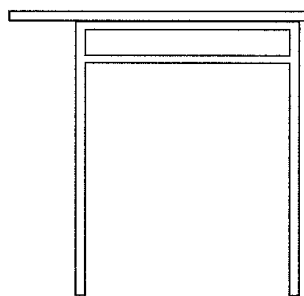
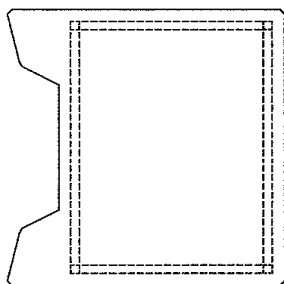

01154-03

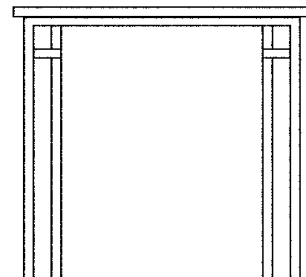
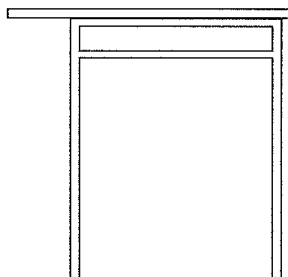
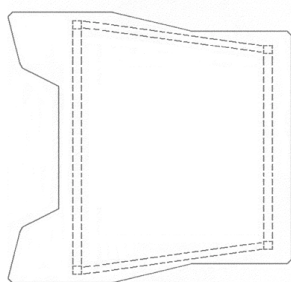

01154-04

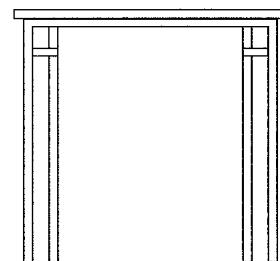
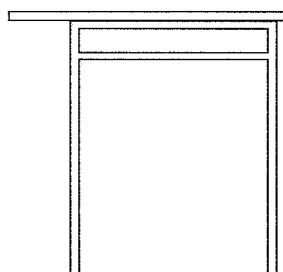
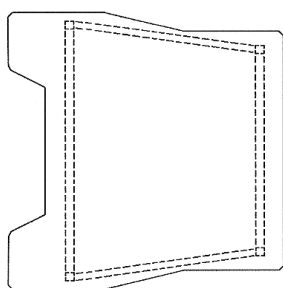

(11) Registreeringu number	01155	(51) Klass: 06-09, 07-02
(21) Taotluse number	D200600005	
(15) Registreerimise päev	15.05.2006	
(22) Esitamise päev	02.02.2006	
(24) Registreeringu kehtivuse alguse päev	02.02.2006	
(18) Registreeringu kehtivuse lõppemise päev	02.02.2011	
(28) Variantide arv	2	
(72) Autor	Anne-Ly Nurmõtalo, Katleri 17-72, 13915 Tallinn, EE	
(73) Omanik	Anne-Ly Nurmõtalo, Katleri 17-72, 13915 Tallinn, EE	

(54) Nimetus **Padi/kohvikannusoojendaja "Kass"**

(55) Reproduktsoon

01155-01

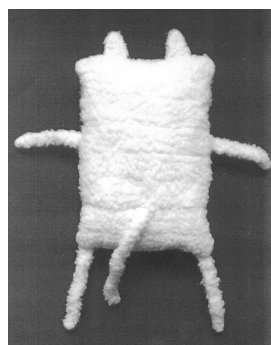
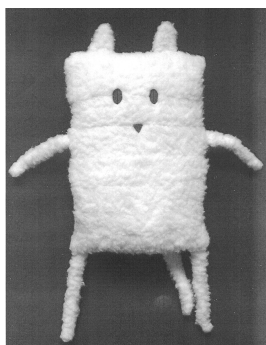

01155-02

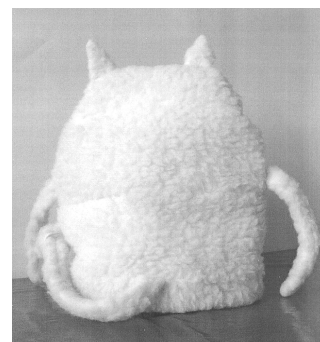
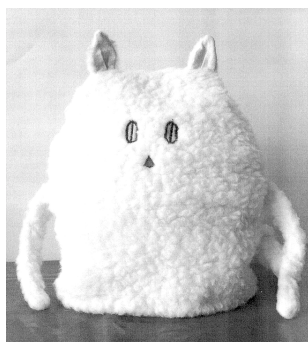

(11) **Registreeringu number** **01156**

(51) Klass: **09-01**

(21) **Taotluse number** D200600006

(15) **Registreerimise päev** 15.05.2006

(22) **Esitamise päev** 14.02.2006

(24) **Registreeringu kehtivuse alguse päev** 14.02.2006

(18) **Registreeringu kehtivuse lõppemise päev** 14.02.2011

(28) **Variantide arv** 1

(72) **Autor** *Autori andmeid ei avalikustata*

(73) **Omanik** Logistikaekspert OÜ, Paide tee 30, Koeru, 73001 Järva maakond, EE

(74) **Patendivolinik või ühine esindaja** Heinu Koitel

(54) **Nimetus** **Pudel**

(55) **Reproduksioon**

01156-01

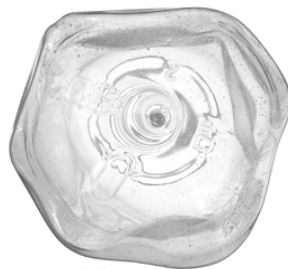

- (11) **Registreeringu number** **01157** (51) Klass: **02-02**
- (21) **Taotluse number** D200600008
- (15) **Registreerimise päev** 15.05.2006
- (22) **Esitamise päev** 01.03.2006
- (24) **Registreeringu kehtivuse alguse päev** 01.03.2006
- (18) **Registreeringu kehtivuse lõppemise päev** 01.03.2011
- (28) **Variantide arv** 2
- (72) **Autor** Trine Lepatriinu Elisabet Wiiburg, Ulricehamnsvägen 35, 1 tr, SE-121 39 Johanneshov, SE
- (73) **Omanik** Trine Lepatriinu Elisabet Wiiburg, Ulricehamnsvägen 35, 1tr, SE-121 39 Johanneshov, SE
- (74) **Patendivolinik või ühine esindaja** Jaak Ostrat
- (54) **Nimetus** **Lepatriinu rannamantel**
- (55) **Reproduksioon**

01157-01

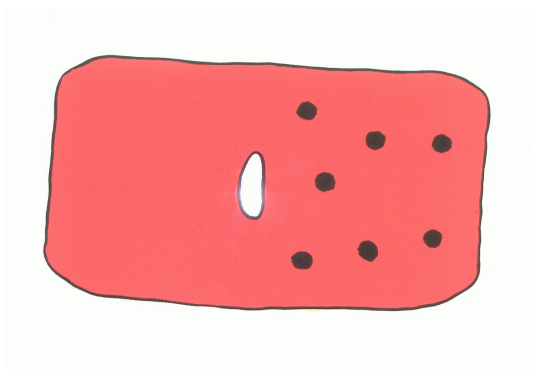

01157-02

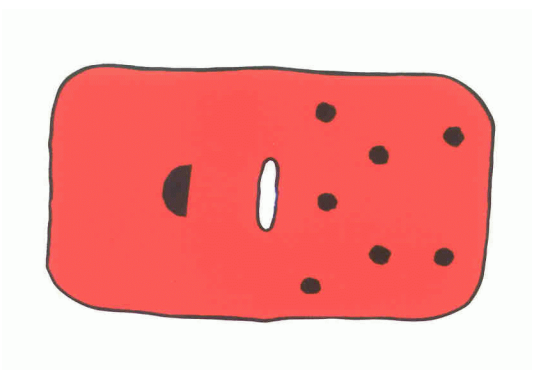

(11) Registreeringu number	01158	(51) Klass: 02-06
(21) Taotluse number	D200600009	
(15) Registreerimise päev	15.05.2006	
(22) Esitamise päev	06.03.2006	
(24) Registreeringu kehtivuse alguse päev	06.03.2006	
(18) Registreeringu kehtivuse lõppemise päev	06.03.2011	
(28) Variantide arv	2	
(72) Autor	Evelyn Toomistu, Orgita 30-21, Märjamaa vald, 78313 Rapla maakond, EE	
(73) Omanik	Evelyn Toomistu, Orgita 30-21, Märjamaa vald, Rapla, 78313 Rapla maakond, EE	

(54) Nimetus **Sõrmlabak/sõrglabak**

(55) Reproduksioon

01158-01

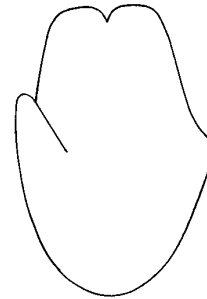
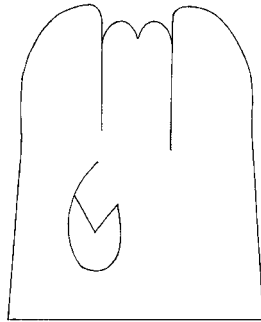

01158-02

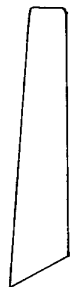
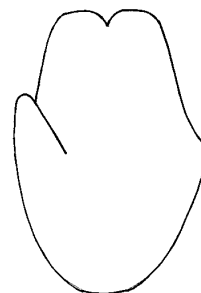
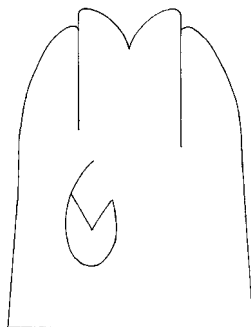

(11) Registreeringu number	01159	(51) Klass: 14-03
(21) Taotluse number	D200500078	
(15) Registreerimise päev	15.05.2006	
(22) Esitamise päev	09.12.2005	
(24) Registreeringu kehtivuse alguse päev	09.12.2005	
(18) Registreeringu kehtivuse lõppemise päev	09.12.2010	
(28) Variantide arv	1	
(30) Prioriteediandmed	29/231,713, 09.06.2005, US	
(72) Autor	Duncan Burns, #203 18645 Hatteras St., Tarzana, CA 91356, US Justin Lyles, 12278 Scripps Summit Drive, San Diego, CA 92131, US Aaron Moss, 33 Queens Road, North Warnborough, Hampshire RG29 1DN, GB	
(73) Omanik	Nokia Corporation, Keilalahdentie 4, FIN-02150 Espoo, FI	
(74) Patendivolinik või ühine esindaja	Kalev Käosaar	

(54) Nimetus **Käsitelefon**

(55) Reproduktsoon

01159-01

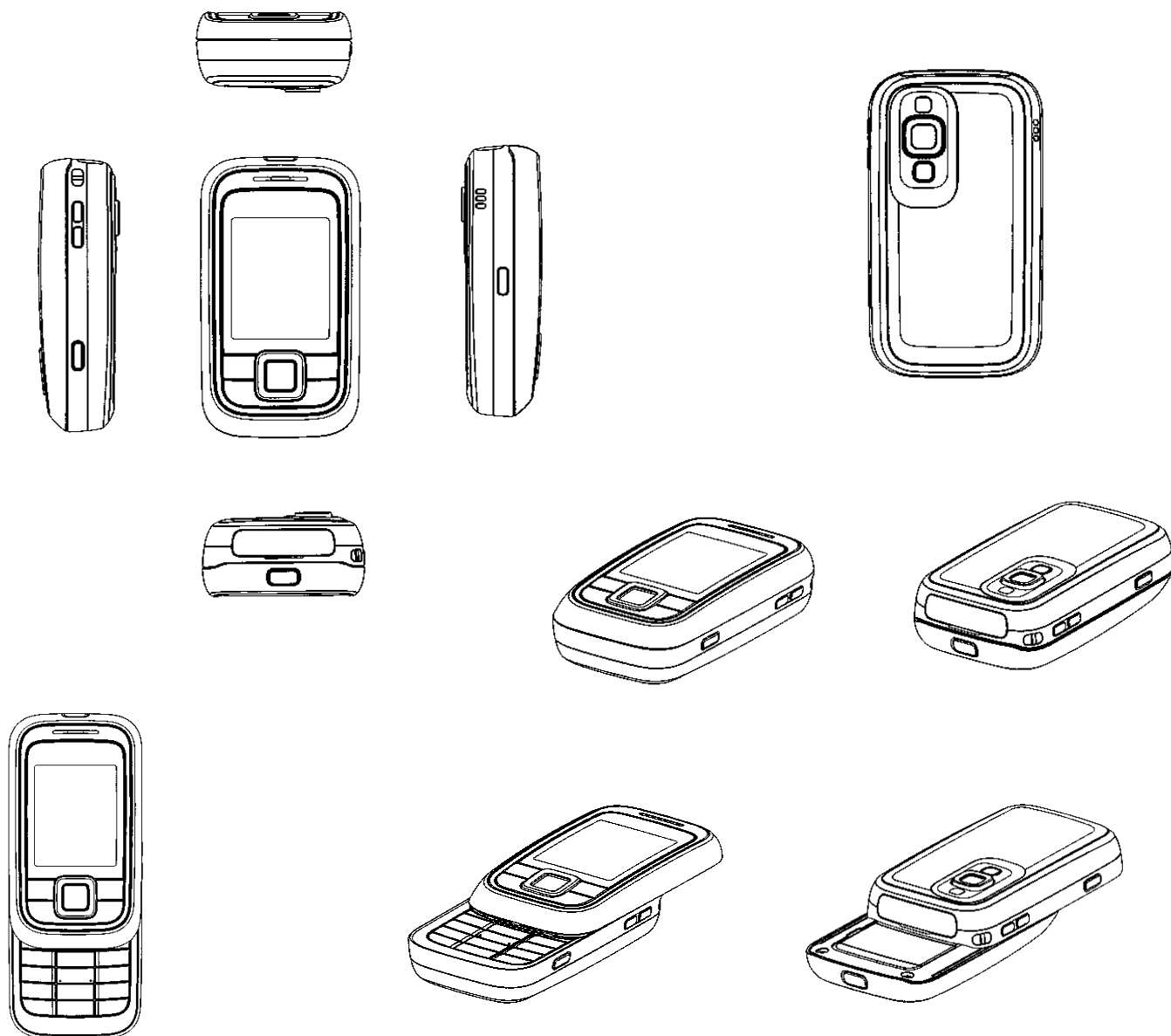

- (11) **Registreeringu number** **01160** (51) Klass: **23-02**
- (21) **Taotluse number** D200500076
- (15) **Registreerimise päev** 15.05.2006
- (22) **Esitamise päev** 08.12.2005
- (24) **Registreeringu kehtivuse alguse päev** 08.12.2005
- (18) **Registreeringu kehtivuse lõppemise päev** 08.12.2010
- (28) **Variantide arv** 2
- (72) **Autor** Rein Talpsepp, Pae 17a-22, 11414 Tallinn, EE
Tarmo Talpsepp, Pae 17a-22, 11414 Tallinn, EE
Terje Talpsepp, Pae 17a-22, 11414 Tallinn, EE
- (73) **Omanik** Rein Talpsepp, Pae 17a-22, 11414 Tallinn, EE
Terje Talpsepp, Pae 17a-22, 11414 Tallinn, EE
Tarmo Talpsepp, Pae 17a-22, 11414 Tallinn, EE
- (54) **Nimetus** **Dušiga tualettruum (moodulina)**
- (55) **Reproduksioon**

01160-01

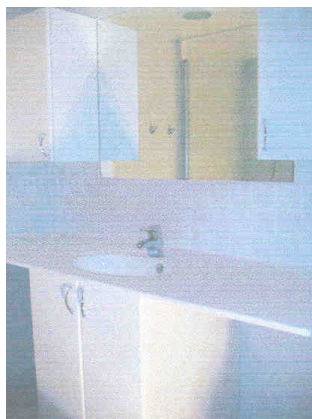

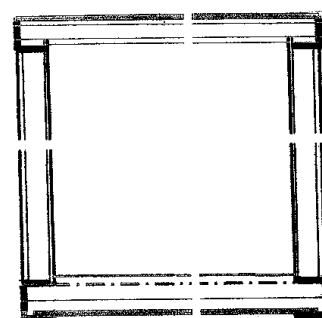
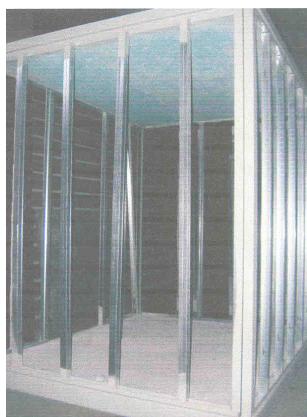
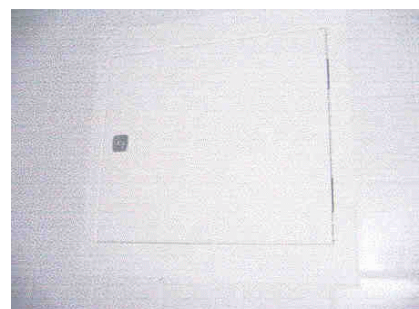

01160-02



- (11) **Registreeringu number** **01161** (51) Klass: **09-03**
- (21) **Taotluse number** D200600011
- (15) **Registreerimise päev** 15.05.2006
- (22) **Esitamise päev** 14.03.2006
- (24) **Registreeringu kehtivuse alguse päev** 14.03.2006
- (18) **Registreeringu kehtivuse lõppemise päev** 14.03.2011
- (28) **Variantide arv** 2
- (72) **Autor** Jaanika Granbak, Aasa 7-1, Tallinn, 10122 Harju maakond, EE
Gert Granbak, Aasa 7-1, Tallinn, 10122 Harju maakond, EE
- (73) **Omanik** GLOB OÜ, Aasa 7-1, Tallinn, 10122 Harju maakond, EE
- (54) **Nimetus** **Lõikelille kinkekarp**
- (55) **Reproduktsoon**

01161-01

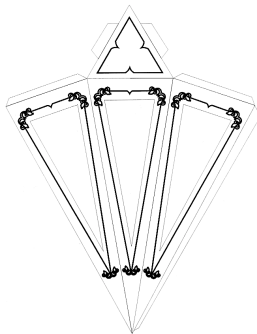

01161-02

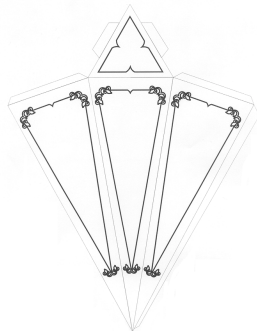

(11) Registreeringu number	01162	(51) Klass: 25-03
(21) Taotluse number	D200600013	
(15) Registreerimise päev	15.05.2006	
(22) Esitamise päev	15.03.2006	
(24) Registreeringu kehtivuse alguse päev	15.03.2006	
(18) Registreeringu kehtivuse lõppemise päev	15.03.2011	
(28) Variantide arv	2	
(72) Autor	Taavi Kuningas, Kalda talu, Veelikse küla, Saarde vald, 86102 Pärnu maakond, EE	
(73) Omanik	Indrek Jõeäär, Ristiku 20, Kuressaare, 93811 Saare maakond, EE	
(74) Patendivolinik või ühine esindaja	Lembit Mitt	

(54) Nimetus **Pukktuulik-maja**

(55) Reproduktsoon

01162-01



01162-02



(11) Registreeringu number	01163	(51) Klass: 14-01, 14-02, 14-03
(21) Taotluse number	D200600014	
(15) Registreerimise päev	15.05.2006	
(22) Esitamise päev	20.03.2006	
(24) Registreeringu kehtivuse alguse päev	20.03.2006	
(18) Registreeringu kehtivuse lõppemise päev	20.03.2011	
(28) Variantide arv	1	
(30) Prioriteediandmed	M20050144, 21.09.2005, FI	
(72) Autor	Nora Brelo, Toivontie 60, 90530 Oulu, FI	
(73) Omanik	Nokia Corporation, Keilalahdentie 4, FIN-02150 Espoo, FI	
(74) Patendivolinik või ühine esindaja	Kalev Käosaar	

(54) Nimetus **Käsitelefon / muusikaseade**

(55) Reproduksioon

01163-01

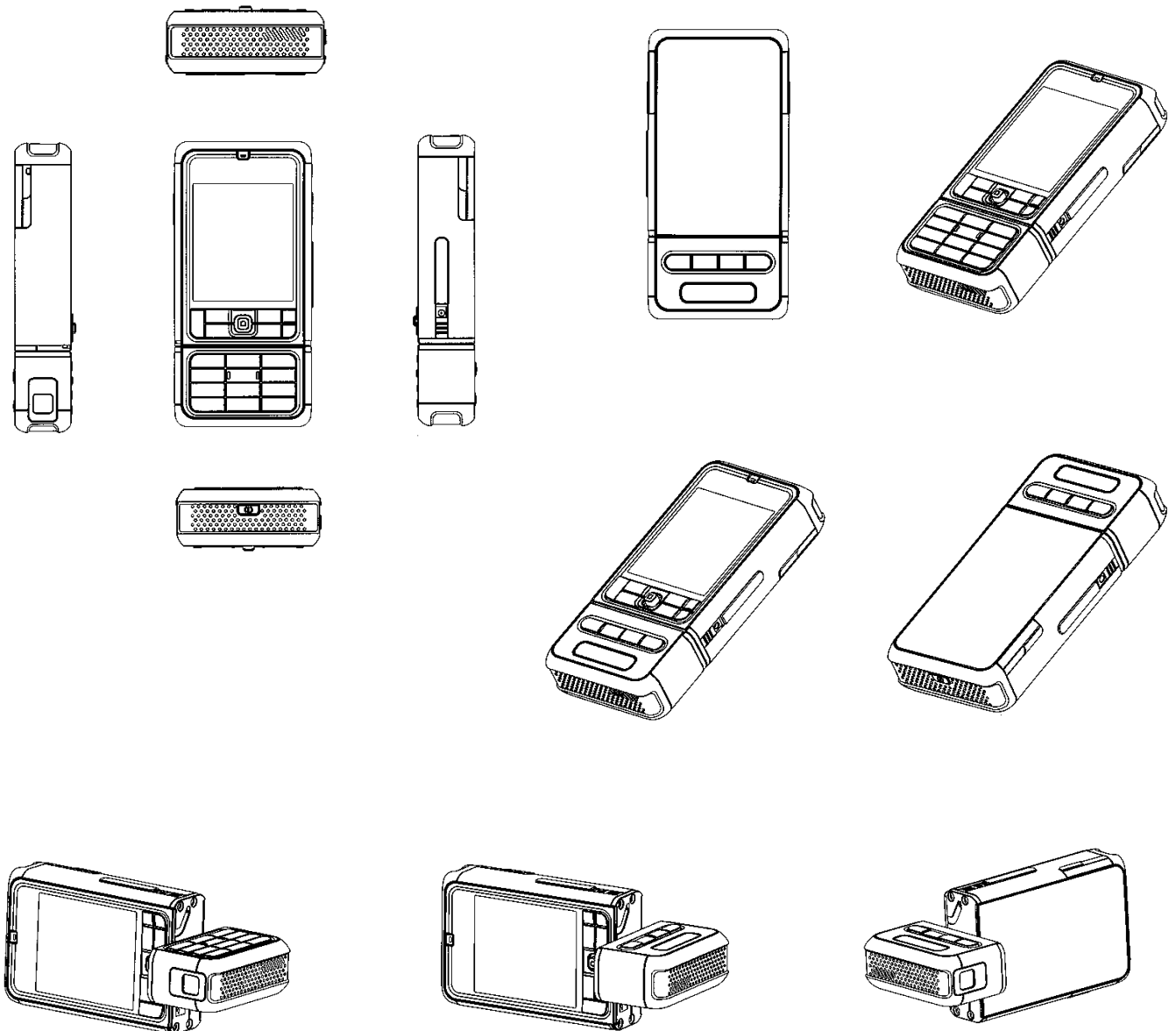

II. RAHVUSVAHELISELT REGISTREERITUD TÖÖSTUSDISAINILAHENDUSED

Avaldatakse "Tööstusdisaini kaitse seaduse" § 87⁴ lõike37 alusel.

- (11) **Rahvusvah reg nr** **DM/066091** (51) Klass: **06-07**
- (21) **Rahvusvah reg jrk** H200500114
- (15) **Registreeringu päev** 31.08.2004
- (22) **Esitamise päev** 31.08.2004
- (28) **Variantide arv** 2
- (72) **Autor** Marianna N. Berg, c/o ARIS International SA, 2 Kolinplatz, CH-6300 Zug, CH
- (73) **Omanik** ARIS INTERNATIONAL SA, 2 Kolinplatz, CH-6300 Zug, CH
- WIPO Rahvusvah Tööstusdisainilahenduste Bülletääni nr, kus registreering on avaldatud** 2005/07

(54) **Nimetus** **Table-top mirrors**

(55) **Reproduksioon**

DM/066091-01

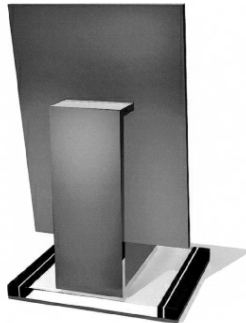
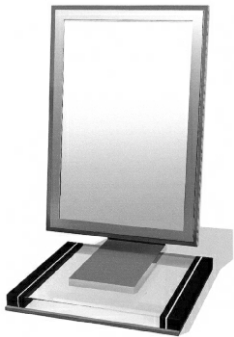

DM/066091-02

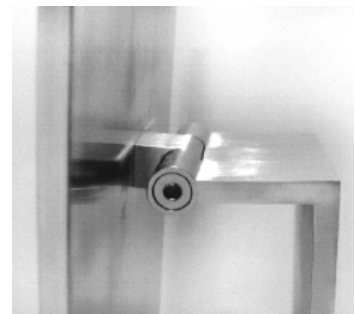

(11) Rahvusvah reg nr	DM/066092	(51) Klass: 16-06
(21) Rahvusvah reg jrk	H200500115	
(15) Registreeringu päev	31.08.2004	
(22) Esitamise päev	31.08.2004	
(28) Variantide arv	1	
(72) Autor	Marianna N. Berg, c/o ARIS International SA, 2 Kolinplatz, CH-6300 Zug, CH	
(73) Omanik	ARIS INTERNATIONAL SA, 2 Kolinplatz, CH-6300 Zug, CH	
WIPO Rahvusvah Tööstusdisainilahenduste Bülletääni nr, kus registreering on avaldatud	2005/07	

(54) **Nimetus** **Magnifying glass with mounting system and tools**

(55) **Reproduksioon**

DM/066092-01



(11) Rahvusvah reg nr	DM/066093	(51) Klass: 03-01
(21) Rahvusvah reg jrk	H200500116	
(15) Registreeringu päev	31.08.2004	
(22) Esitamise päev	31.08.2004	
(28) Variantide arv	2	
(72) Autor	Marianna N. Berg, c/o ARIS International SA, 2 Kolinplatz, CH-6300 Zug, CH	
(73) Omanik	ARIS INTERNATIONAL SA, 2 Kolinplatz, CH-6300 Zug, CH	
WIPO Rahvusvah Tööstusdisainilahenduste Bülletääni nr, kus registreering on avaldatud	2005/07	

(54) **Nimetus** **1. Notepad holder; 2. Business cards/credit cards holder**

(55) **Reproduksioon**

DM/066093-01

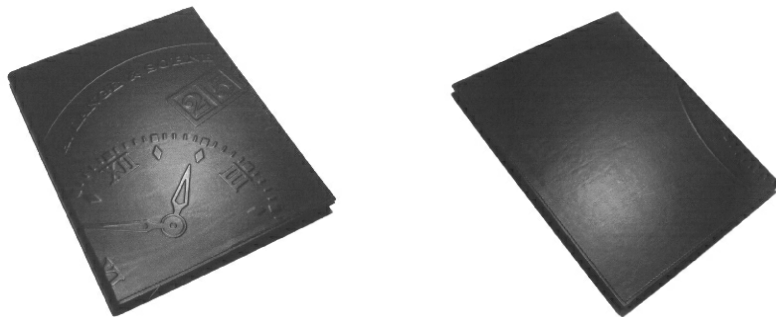

DM/066093-02

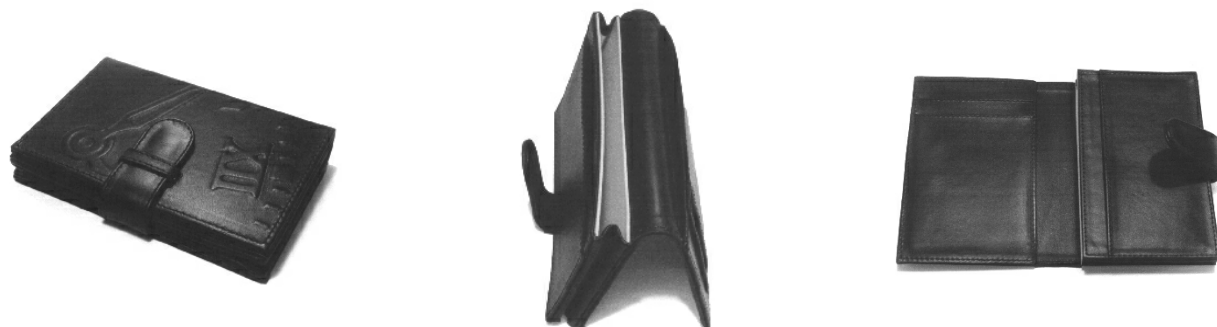

(11) Rahvusvah reg nr	DM/066094	(51) Klass: 03-01
(21) Rahvusvah reg jrk	H200500117	
(15) Registreeringu päev	31.08.2004	
(22) Esitamise päev	31.08.2004	
(28) Variantide arv	1	
(72) Autor	Marianna N. Berg, c/o ARIS International SA, 2 Kolinplatz, CH-6300 Zug, CH	
(73) Omanik	ARIS INTERNATIONAL SA, 2 Kolinplatz, CH-6300 Zug, CH	
WIPO Rahvusvah Tööstusdisainilahenduste		
Bülletääni nr, kus registreering on avaldatud	2005/07	

(54) **Nimetus** **Round travel case with curved lock**

(55) **Reproduksioon**

DM/066094-01



- (11) **Rahvusvah reg nr** DM/066095 (51) Klass: **10-07**
- (21) **Rahvusvah reg jrk** H200500118
- (15) **Registreeringu päev** 31.08.2004
- (22) **Esitamise päev** 31.08.2004
- (28) **Variantide arv** 1
- (72) **Autor** Marianna N. Berg, c/o ARIS International SA, 2 Kolinplatz, CH-6300 Zug, CH
- (73) **Omanik** ARIS INTERNATIONAL SA, 2 Kolinplatz, CH-6300 Zug, CH
- WIPO Rahvusvah Tööstusdisainilahenduste**
Bülletääni nr, kus registreering on avaldatud 2005/07

(54) **Nimetus** **Electrical watch winding mechanism**

(55) **Reproduktsoon**

DM/066095-01

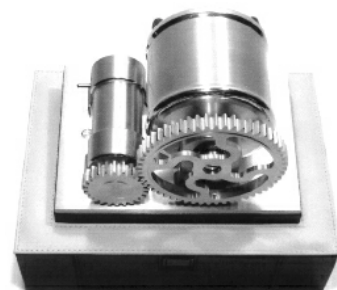
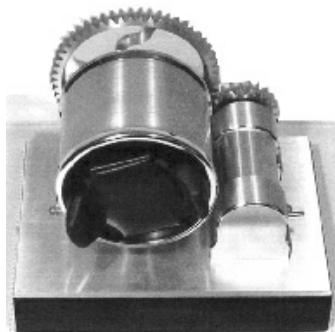

- | | | |
|---------------------------------|---|--------------------------|
| (11) Rahvusvah reg nr | DM/066161 | (51) Klass: 19-07 |
| (21) Rahvusvah reg jrk | H200500119 | |
| (15) Registreeringu päev | 02.08.2004 | |
| (22) Esitamise päev | 02.08.2004 | |
| (28) Variantide arv | 1 | |
| (72) Autor | Andreas Jesse, Chemin du Pastel 10, CH-1218 Le Grand-Saconnex, CH | |
| (73) Omanik | ANDREAS JESSE, Chemin du Pastel 10, CH-1218 Le Grand-Saconnex, CH | |

WIPO Rahvusvah Tööstusdisainilahenduste Bülletääni nr, kus registreering on avaldatud 2005/07

(54) **Nimetus** **Folding teaching model**

(55) **Reproduktsoon**

DM/066161-01

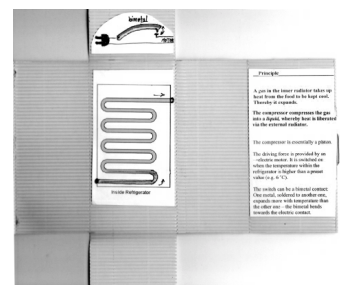
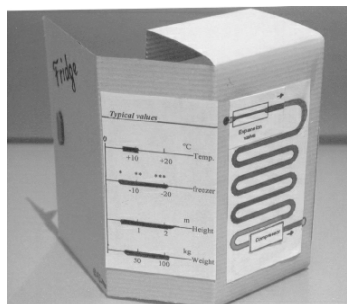

(11) Rahvusvah reg nr	DM/066381	(51) Klass: 11-01
(21) Rahvusvah reg jrk	H200500056	
(15) Registreeringu päev	28.02.2005	
(22) Esitamise päev	28.02.2005	
(28) Variantide arv	8	
(72) Autor	Arlette Elsa EMCH DUCOMMUN, rue des Mornets 31, CH-2520 LA NEUVILLE, CH	
(73) Omanik	OMEGA SA (OMEGA AG) (OMEGA LTD.), Jakob-Stämpfli-Strasse 96, CH-2502 Biel/Bienne, CH	
WIPO Rahvusvah Tööstusdisainilahenduste Bülletääni nr, kus registreering on avaldatud	2005/03	

(54) **Nimetus** **Jewellery, including rings**

(55) **Reproduksioon**

DM/066381-01



DM/066381-02



DM/066381-03



DM/066381-04



DM/066381-05



DM/066381-06



DM/066381-07



DM/066381-08



(11) Rahvusvah reg nr	DM/066382	(51) Klass: 10-02
(21) Rahvusvah reg jrk	H200500057	
(15) Registreeringu päev	28.02.2005	
(22) Esitamise päev	28.02.2005	
(28) Variantide arv	1	
(72) Autor	Danilo SALA, SWATCHLAB, Via Archimede 6, IT-20129 MILANO, IT	
(73) Omanik	SWATCH AG (SWATCHSA) (SWATCHLTD.), 94, Rue Jakob Stämpfli, CH-2502 BIENNE, CH	
WIPO Rahvusvah Tööstusdisainilahenduste Bülletääni nr, kus registreering on avaldatud	2005/03	

(54) **Nimetus** **Wristwatch**

(55) **Reproduktsoon**

DM/066382-01



(11) Rahvusvah reg nr	DM/066383	(51) Klass: 10-02
(21) Rahvusvah reg jrk	H200500058	
(15) Registreeringu päev	28.02.2005	
(22) Esitamise päev	28.02.2005	
(28) Variantide arv	1	
(72) Autor	Corinne KAESER, SWATCH SA, 94, Rue Jakob Stämpfli, CH-2502 BIENNE, CH	
(73) Omanik	SWATCH AG (SWATCH SA) (SWATCH LTD.), 94, Rue Jakob Stämpfli, CH-2502 BIENNE, CH	

**WIPO Rahvusvah Tööstusdisainilahenduste
Bülletääni nr, kus registreering on avaldatud** 2005/03

(54) **Nimetus** **Wristwatch**

(55) **Reproduksioon**

DM/066383-01



- (11) **Rahvusvah reg nr** **DM/066384** (51) Klass: **10-07**
- (21) **Rahvusvah reg jrk** H200500059
- (15) **Registreeringu päev** 25.02.2005
- (22) **Esitamise päev** 25.02.2005
- (28) **Variantide arv** 2
- (72) **Autor** Manuel EMCH, MONTRES JAQUET DROZ SA
(Montres Jaquet Droz AG) (Montres Jaquet Droz Ltd.), 5, rue Jaquet Droz,
CH-2300 La Chaux-de-Fonds, CH
- (73) **Omanik** MONTRES JAQUET DROZ SA
(MONTRES JAQUET DROZ AG) (MONTRES JAQUET DROZ LTD.),
5, rue Jaquet Droz, CH-2300 La Chaux-de-Fonds, CH

WIPO Rahvusvah Tööstusdisainilahenduste
Bülletääni nr, kus registreering on avaldatud 2005/03

(54) **Nimetus** **Watch dials**

(55) **Reproduktsoon**

DM/066384-01



DM/066384-02

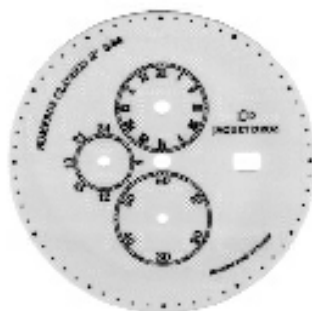

(11) Rahvusvah reg nr	DM/066407	(51) Klass: 10-02
(21) Rahvusvah reg jrk	H200500063	
(15) Registreeringu päev	17.02.2005	
(22) Esitamise päev	17.02.2005	
(28) Variantide arv	1	
(72) Autor	Corinne KAESER, SWATCH SA, 94, Rue Jakob Stämpfli, CH-2502 BIENNE, CH	
(73) Omanik	SWATCH AG (SWATCH SA) (SWATCH LTD.), 94, Rue Jakob Stämpfli, CH-2502 BIENNE, CH	

**WIPO Rahvusvah Tööstusdisainilahenduste
Bülletääni nr, kus registreering on avaldatud** 2005/03

(54) **Nimetus** **Wristwatch**

(55) **Reproduksioon**

DM/066407-01



(11) Rahvusvah reg nr	DM/066424	(51) Klass: 10-02
(21) Rahvusvah reg jrk	H200500066	
(15) Registreeringu päev	16.03.2005	
(22) Esitamise päev	16.03.2005	
(28) Variantide arv	1	
(72) Autor	Jerry Simonis, Jolimont 1, 2400 Le Locle, CH	
(73) Omanik	THE SWATCH GROUP MANAGEMENT SERVICES AG (THE SWATCH GROUP MANAGEMENT SERVICES SA), (THE SWATCH GROUP MANAGEMENT SERVICES LTD), Seevorstadt 6, CH-2502 Biel/Bienne, CH	

**WIPO Rahvusvah Tööstusdisainilahenduste
Bülletääni nr, kus registreering on avaldatud** 2005/03

(54) **Nimetus** **Wristwatch**

(55) **Reproduktsoon**

DM/066424-01



(11) Rahvusvah reg nr	DM/066463	(51) Klass: 10-02
(21) Rahvusvah reg jrk	H200500069	
(15) Registreeringu päev	08.03.2005	
(22) Esitamise päev	08.03.2005	
(28) Variantide arv	1	
(72) Autor	Davide Mariani, SWATCHLAB, Via Archimede 6, IT-20129 MILANO, IT	
(73) Omanik	SWATCH AG (SWATCH SA) (SWATCH LTD.), 94, Rue Jakob Stämpfli, CH-2502 BIENNE, CH	
WIPO Rahvusvah Tööstusdisainilahenduste Bületääni nr, kus registreering on avaldatud	2005/03	

(54) **Nimetus** **Wristwatch**

(55) **Reproduktsoon**

DM/066463-01



(11) Rahvusvah reg nr	DM/066464	(51) Klass: 10-02
(21) Rahvusvah reg jrk	H200500070	
(15) Registreeringu päev	08.03.2005	
(22) Esitamise päev	08.03.2005	
(28) Variantide arv	1	
(72) Autor	Malcolm Dragotta, SWATCHLAB, Via Archimede 6, IT-20129 MILANO, IT	
(73) Omanik	SWATCH AG (SWATCH SA) (SWATCH LTD.), 94, Rue Jakob Stämpfli, CH-2502 BIENNE, CH	

**WIPO Rahvusvah Tööstusdisainilahenduste
Bülletääni nr, kus registreering on avaldatud** 2005/03

(54) **Nimetus** **Wristwatch**

(55) **Reproduksioon**

DM/066464-01



(11) Rahvusvah reg nr	DM/066465	(51) Klass: 10-02
(21) Rahvusvah reg jrk	H200500071	
(15) Registreeringu päev	08.03.2005	
(22) Esitamise päev	08.03.2005	
(28) Variantide arv	1	
(72) Autor	Walter GARRO, SWATCHLAB, Via Archimede 6, IT-20129 MILANO, IT	
(73) Omanik	SWATCH AG (SWATCH SA) (SWATCH LTD.), 94, Rue Jakob Stämpfli, CH-2502 BIENNE, CH	

WIPO Rahvusvah Tööstusdisainilahenduste
Bülletääni nr, kus registreering on avaldatud 2005/03

(54) **Nimetus** **Wristwatch**

(55) **Reproduksioon**

DM/066465-01



(11) Rahvusvah reg nr	DM/066522	(51) Klass: 10-02
(21) Rahvusvah reg jrk	H200500075	
(15) Registreeringu päev	24.03.2005	
(22) Esitamise päev	24.03.2005	
(28) Variantide arv	1	
(72) Autor	Mireille GUINARD, Les Arces, 8, chemin du Grand Mont, F-25500 MORTEAU, FR	
(73) Omanik	TISSOT S.A., 17, chemin des Tourelles, CH-2400 Le Locle, CH	
WIPO Rahvusvah Tööstusdisainilahenduste Bülletääni nr, kus registreering on avaldatud	2005/04	

(54) **Nimetus** **Wristwatch**

(55) **Reproduksioon**

DM/066522-01



(11) **Rahvusvah reg nr** DM/066522 (51) Klass: **10-02**
(21) **Rahvusvah reg jrk** H200500075A
(15) **Registreeringu päev** 24.03.2005
(22) **Esitamise päev** 24.03.2005
(28) **Variantide arv** 1
(72) **Autor** Mireille GUINARD, Les Arces, 8, chemin du Grand Mont,
FR-25500 MORTEAU, FR
(73) **Omanik** TISSOT S.A., 17, chemin des Tourelles, CH-2400 Le Locle, CH
WIPO Rahvusvah Tööstusdisainilahenduste
Bülletääni nr, kus registreering on avaldatud 2005/04

(54) **Nimetus** Wristwatch

(55) **Reproduktsoon**

DM/066522-01



(11) Rahvusvah reg nr	DM/066560	(51) Klass: 10-02
(21) Rahvusvah reg jrk	H200500086	
(15) Registreeringu päev	25.04.2005	
(22) Esitamise päev	25.04.2005	
(28) Variantide arv	1	
(72) Autor	Adelina BISSOLO, SWATCHLAB, Via Archimede 6, IT-20129 Milano, IT	
(73) Omanik	SWATCH AG (SWATCH SA) (SWATCH LTD.), 94, Rue Jakob Stämpfli, CH-2502 BIENNE, CH	
WIPO Rahvusvah Tööstusdisainilahenduste Bülletääni nr, kus registreering on avaldatud	2005/04	

(54) **Nimetus** **Wristwatch**

(55) **Reproduktsoon**

DM/066560-01



(11) Rahvusvah reg nr	DM/066573	(51) Klass: 10-02
(21) Rahvusvah reg jrk	H200500141	
(15) Registreeringu päev	19.04.2005	
(22) Esitamise päev	19.04.2005	
(28) Variantide arv	1	
(72) Autor	Alain BAJULAZ, 7, rue de Artisans, CH-1299 Crans-sur-Céligny, CH	
(73) Omanik	RJ WATCHES SA, 9, rue du Marché, CH-1204 Genève, CH	
WIPO Rahvusvah Tööstusdisainilahenduste		
Bülletääni nr, kus registreering on avaldatud	2005/09	

(54) **Nimetus** **Watch**

(55) **Reproduktsoon**

DM/066573-01



(11) Rahvusvah reg nr	DM/066648	(51) Klass: 10-02
(21) Rahvusvah reg jrk	H200500091	
(15) Registreeringu päev	09.05.2005	
(22) Esitamise päev	09.05.2005	
(28) Variantide arv	1	
(72) Autor	Andrea Arrigoni, SWATCHLAB, Via Archimede 6, IT-20129 MILANO, IT	
(73) Omanik	SWATCH AG (SWATCH SA) (SWATCH LTD.), 94, Rue Jakob Stämpfli, CH-2502 BIENNE, CH	
WIPO Rahvusvah Tööstusdisainilahenduste Bülletääni nr, kus registreering on avaldatud	2005/05	

(54) **Nimetus** **Wristwatch**

(55) **Reproduktsoon**

DM/066648-01



(11) Rahvusvah reg nr	DM/066792	(51) Klass: 10-02
(21) Rahvusvah reg jrk	H200500122	
(15) Registreeringu päev	01.07.2005	
(22) Esitamise päev	01.07.2005	
(28) Variantide arv	1	
(72) Autor	Fabrice DUPONT, DUPONT DESIGN SA, Route des Jeunes 33, CH-1227 CAROUGE, CH	
(73) Omanik	SWATCH AG (SWATCH SA) (SWATCH LTD.), 94, Rue Jakob Stämpfli, CH-2502 BIENNE, CH	

**WIPO Rahvusvah Tööstusdisainilahenduste
Bülletääni nr, kus registreering on avaldatud** 2005/07

(54) **Nimetus** **Wristwatch**

(55) **Reproduksioon**

DM/066792-01



(11) Rahvusvah reg nr	DM/066803	(51) Klass: 10-02
(21) Rahvusvah reg jrk	H200500123	
(15) Registreeringu päev	01.07.2005	
(22) Esitamise päev	01.07.2005	
(28) Variantide arv	1	
(72) Autor	Arnaud Blaszczyk, DUPONT DESIGN SA, Rte des Jeunes 33, CH-1227 Carouge, CH	
(73) Omanik	SWATCH AG (SWATCH SA) (SWATCH LTD.), 94, Rue Jakob Stämpfli, CH-2502 BIENNE, CH	

**WIPO Rahvusvah Tööstusdisainilahenduste
Bülletääni nr, kus registreering on avaldatud** 2005/07

(54) **Nimetus** **Wristwatch**

(55) **Reproduktsoon**

DM/066803-01



(11) **Rahvusvah reg nr****DM/066805**(51) Klass: **10-07**(21) **Rahvusvah reg jrk**

H200500124

(15) **Registreeringu päev**

01.07.2005

(22) **Esitamise päev**

01.07.2005

(28) **Variantide arv**

1

(72) **Autor**

Alexandra Figueiredo, CDNP - A Division of the Swatch Group Management Services Ltd., Schützengasse 30, CH-2540 GRENCHEN, CH
 SWATCH AG (SWATCH SA) (SWATCH LTD.), 94, Rue Jakob Stämpfli, CH-2502 BIENNE, CH

(73) **Omanik****WIPO Rahvusvah Tööstusdisainilahenduste****Bülletääni nr, kus registreering on avaldatud** 2005/07(54) **Nimetus****Watch case**(55) **Reproduksioon**

DM/066805-01

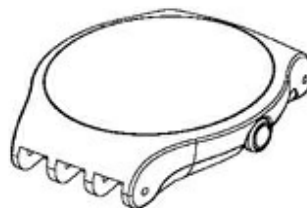
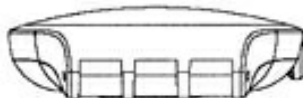
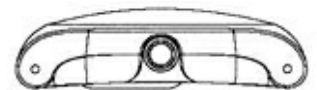
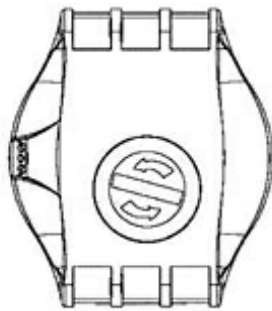
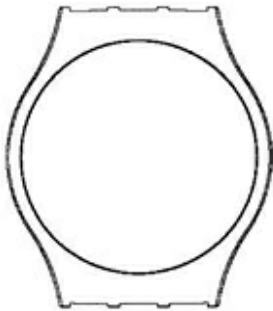

(11) Rahvusvah reg nr	DM/066806	(51) Klass: 10-02
(21) Rahvusvah reg jrk	H200500125	
(15) Registreeringu päev	01.07.2005	
(22) Esitamise päev	01.07.2005	
(28) Variantide arv	1	
(72) Autor	Fabrice DUPONT, DUPONT DESIGN SA, Route des Jeunes 33, CH-1227 CAROUGE, CH	
(73) Omanik	SWATCH AG (SWATCH SA) (SWATCH LTD.), 94, Rue Jakob Stämpfli, CH-2502 BIENNE, CH	

**WIPO Rahvusvah Tööstusdisainilahenduste
Bülletääni nr, kus registreering on avaldatud** 2005/07

(54) **Nimetus** **Wristwatch**

(55) **Reproduktsoon**

DM/066806-01



(11) Rahvusvah reg nr	DM/066808	(51) Klass: 10-02
(21) Rahvusvah reg jrk	H200500126	
(15) Registreeringu päev	01.07.2005	
(22) Esitamise päev	01.07.2005	
(28) Variantide arv	1	
(72) Autor	Adelina BISSOLO, SWATCHLAB, Via Archimede 6, IT-20129 MILANO, IT	
(73) Omanik	SWATCH AG (SWATCH SA) (SWATCH LTD.), 94, Rue Jakob Stämpfli, CH-2502 BIENNE, CH	

**WIPO Rahvusvah Tööstusdisainilahenduste
Bülletääni nr, kus registreering on avaldatud** 2005/07

(54) **Nimetus** **Wristwatch**

(55) **Reproduktsoon**

DM/066808-01



- (11) **Rahvusvah reg nr** DM/066810 (51) Klass: **10-07**
- (21) **Rahvusvah reg jrk** H200500127
- (15) **Registreeringu päev** 01.07.2005
- (22) **Esitamise päev** 01.07.2005
- (28) **Variantide arv** 1
- (72) **Autor** Alexandra Figueiredo, CDNP - A Division of the Swatch Group Management Services Ltd., Schützengasse 30, CH-2540 GRENCHEN, CH
SWATCH AG (SWATCH SA) (SWATCH LTD.), 94, Rue Jakob Stämpfli, CH-2502 BIENNE, CH
- (73) **Omanik**

WIPO Rahvusvah Tööstusdisainilahenduste
Bülletääni nr, kus registreering on avaldatud 2005/07

(54) **Nimetus** Watch case

(55) **Reproduksioon**

DM/066810-01

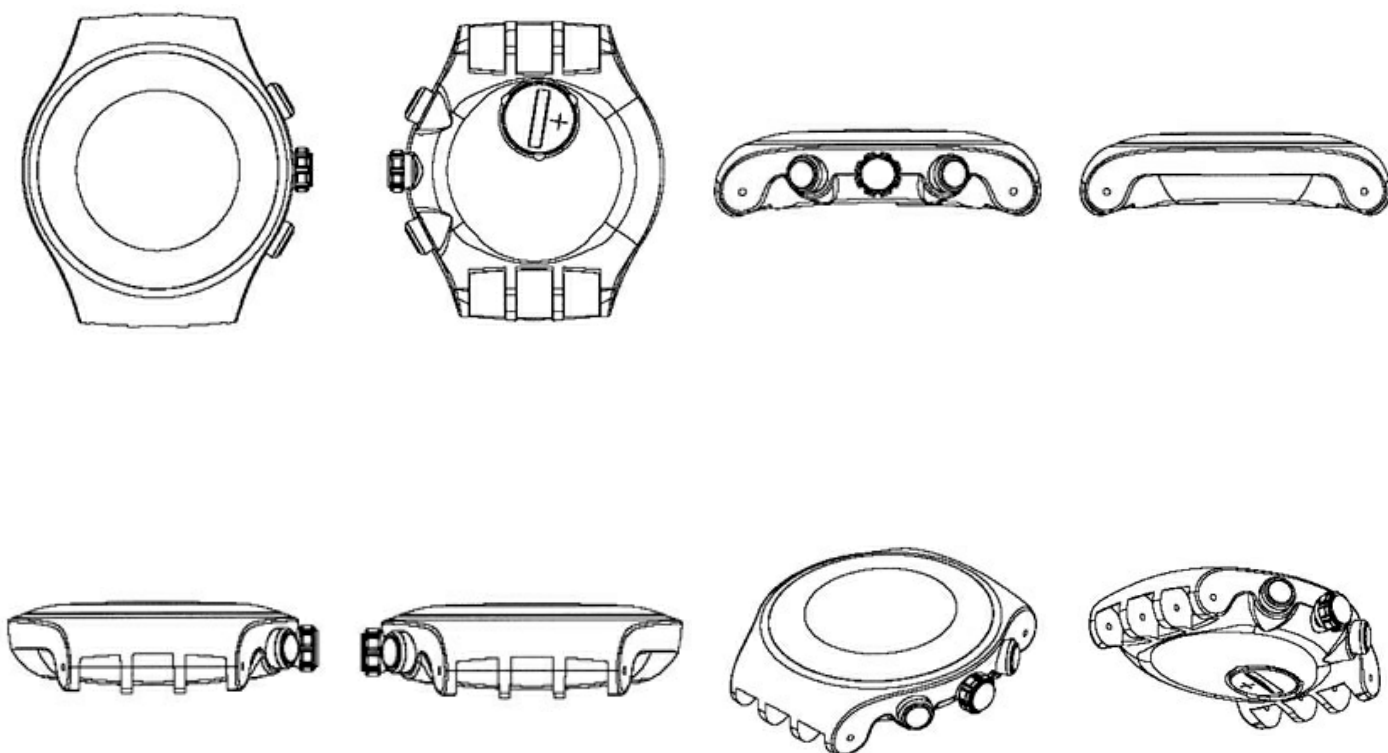

(11) Rahvusvah reg nr	DM/066811	(51) Klass: 10-02
(21) Rahvusvah reg jrk	H200500128	
(15) Registreeringu päev	01.07.2005	
(22) Esitamise päev	01.07.2005	
(28) Variantide arv	1	
(72) Autor	Ciara Baudet, DUPONT DESIGN SA, Route des Jeunes 33, CH-1227 CAROUGE, CH	
(73) Omanik	SWATCH AG (SWATCH SA) (SWATCH LTD.), 94, Rue Jakob Stämpfli, CH-2502 BIENNE, CH	

**WIPO Rahvusvah Tööstusdisainilahenduste
Bülletääni nr, kus registreering on avaldatud** 2005/07

(54) **Nimetus** **Wristwatch**

(55) **Reproduktsoon**

DM/066811-01



(11) Rahvusvah reg nr	DM/066812	(51) Klass: 10-02
(21) Rahvusvah reg jrk	H200500129	
(15) Registreeringu päev	01.07.2005	
(22) Esitamise päev	01.07.2005	
(28) Variantide arv	1	
(72) Autor	Rossana BOFFI, SWATCHLAB, Via Archimede 6, IT-20129 MILANO, IT	
(73) Omanik	SWATCH AG (SWATCH SA) (SWATCH LTD.), 94, Rue Jakob Stämpfli, CH-2502 BIENNE, CH	
WIPO Rahvusvah Tööstusdisainilahenduste Bületääni nr, kus registreering on avaldatud	2005/07	

(54) **Nimetus** **Wristwatch**

(55) **Reproduktsoon**

DM/066812-01



(11) Rahvusvah reg nr	DM/066855	(51) Klass: 02-07
(21) Rahvusvah reg jrk	H200500130	
(15) Registreeringu päev	19.07.2005	
(22) Esitamise päev	19.07.2005	
(28) Variantide arv	1	
(72) Autor	Adelina BISSOLO, SWATCHLAB, Via Archimede 6, IT-20129 MILANO, IT	
(73) Omanik	SWATCH AG (SWATCH SA) (SWATCH LTD.), 94, Rue Jakob Stämpfli, CH-2502 BIENNE, CH	

**WIPO Rahvusvah Tööstusdisainilahenduste
Bülletääni nr, kus registreering on avaldatud** 2005/07

(54) **Nimetus** **Belt**

(55) **Reproduksioon**

DM/066855-01



(11) Rahvusvah reg nr	DM/066860	(51) Klass: 10-02
(21) Rahvusvah reg jrk	H200500131	
(15) Registreeringu päev	19.07.2005	
(22) Esitamise päev	19.07.2005	
(28) Variantide arv	1	
(72) Autor	Adelina BISSOLO, SWATCHLAB, Via Archimede 6, IT-20129 MILANO, IT	
(73) Omanik	SWATCH AG (SWATCH SA) (SWATCH LTD.), 94, Rue Jakob Stämpfli, CH-2502 BIENNE, CH	
WIPO Rahvusvah Tööstusdisainilahenduste Bülletääni nr, kus registreering on avaldatud	2005/07	

(54) **Nimetus** **Wristwatch**

(55) **Reproduktsoon**

DM/066860-01



- (11) **Rahvusvah reg nr** **DM/066861** (51) Klass: **10-02**
- (21) **Rahvusvah reg jrk** H200500132
- (15) **Registreeringu päev** 19.07.2005
- (22) **Esitamise päev** 19.07.2005
- (28) **Variantide arv** 1
- (72) **Autor** Adelina BISSOLO, SWATCHLAB, Via Archimede 6,
IT-20129 MILANO, IT
- (73) **Omanik** SWATCH AG (SWATCH SA) (SWATCH LTD.), 94, Rue Jakob Stämpfli,
CH-2502 BIENNE, CH

WIPO Rahvusvah Tööstusdisainilahenduste
Bülletääni nr, kus registreering on avaldatud 2005/07

(54) **Nimetus** **Wristwatch**

(55) **Reproduksioon**

DM/066861-01



(11) Rahvusvah reg nr	DM/066863	(51) Klass: 10-02
(21) Rahvusvah reg jrk	H200500133	
(15) Registreeringu päev	19.07.2005	
(22) Esitamise päev	19.07.2005	
(28) Variantide arv	1	
(72) Autor	Katia DE CONTI, Dupont Design SA, Rte des Jeunes 33, CH-1227 CAROUGE, CH	
(73) Omanik	SWATCH AG (SWATCH SA) (SWATCH LTD.), 94, Rue Jakob Stämpfli, CH-2502 BIENNE, CH	
WIPO Rahvusvah Tööstusdisainilahenduste Bülletääni nr, kus registreering on avaldatud	2005/07	

(54) **Nimetus** **Wristwatch**

(55) **Reproduktsoon**

DM/066863-01



(11) Rahvusvah reg nr	DM/066864	(51) Klass: 10-02
(21) Rahvusvah reg jrk	H200500134	
(15) Registreeringu päev	19.07.2005	
(22) Esitamise päev	19.07.2005	
(28) Variantide arv	1	
(72) Autor	Léonie COCQUIO, DUPONT DESIGN SA, Rte des Jeunes 33, CH-1227 CAROUGE, CH	
(73) Omanik	SWATCH AG (SWATCH SA) (SWATCH LTD.), 94, Rue Jakob Stämpfli, CH-2502 BIENNE, CH	
WIPO Rahvusvah Tööstusdisainilahenduste Bülletääni nr, kus registreering on avaldatud	2005/07	

(54) **Nimetus** **Wristwatch**

(55) **Reproduktsoon**

DM/066864-01



(11) Rahvusvah reg nr	DM/066865	(51) Klass: 10-02
(21) Rahvusvah reg jrk	H200500135	
(15) Registreeringu päev	19.07.2005	
(22) Esitamise päev	19.07.2005	
(28) Variantide arv	1	
(72) Autor	Arnaud Blaszczyk, DUPONT DESIGN SA, Rte des Jeunes 33, CH-1227 Carouge, CH	
(73) Omanik	SWATCH AG (SWATCH SA) (SWATCH LTD.), 94, Rue Jakob Stämpfli, CH-2502 BIENNE, CH	
WIPO Rahvusvah Tööstusdisainilahenduste Bülletääni nr, kus registreering on avaldatud	2005/07	

(54) **Nimetus** **Wristwatch**

(55) **Reproduksioon**

DM/066865-01



(11) Rahvusvah reg nr	DM/066867	(51) Klass: 10-02
(21) Rahvusvah reg jrk	H200500136	
(15) Registreeringu päev	19.07.2005	
(22) Esitamise päev	19.07.2005	
(28) Variantide arv	1	
(72) Autor	Andrea Arrigoni, SWATCHLAB, Via Archimede 6, IT-20129 MILANO, IT	
(73) Omanik	SWATCH AG (SWATCH SA) (SWATCH LTD.), 94, Rue Jakob Stämpfli, CH-2502 BIENNE, CH	

**WIPO Rahvusvah Tööstusdisainilahenduste
Bülletääni nr, kus registreering on avaldatud** 2005/07

(54) **Nimetus** **Wristwatch**

(55) **Reproduktsoon**

DM/066867-01



- (11) **Rahvusvah reg nr** DM/066874 (51) Klass: **10-02**
- (21) **Rahvusvah reg jrk** H200500140
- (15) **Registreeringu päev** 26.07.2005
- (22) **Esitamise päev** 26.07.2005
- (28) **Variantide arv** 1
- (72) **Autor** Vincent LAUCELLA, route de France 38, CH-1348 LE BRASSUS, CH
- (73) **Omanik** MONTRES BREGUET S.A., CH-1344 L'ABBAYE, CH
- WIPO Rahvusvah Tööstusdisainilahenduste**
Bülletääni nr, kus registreering on avaldatud 2005/08

(54) **Nimetus** Watch

(55) **Reproduksioon**

DM/066874-01

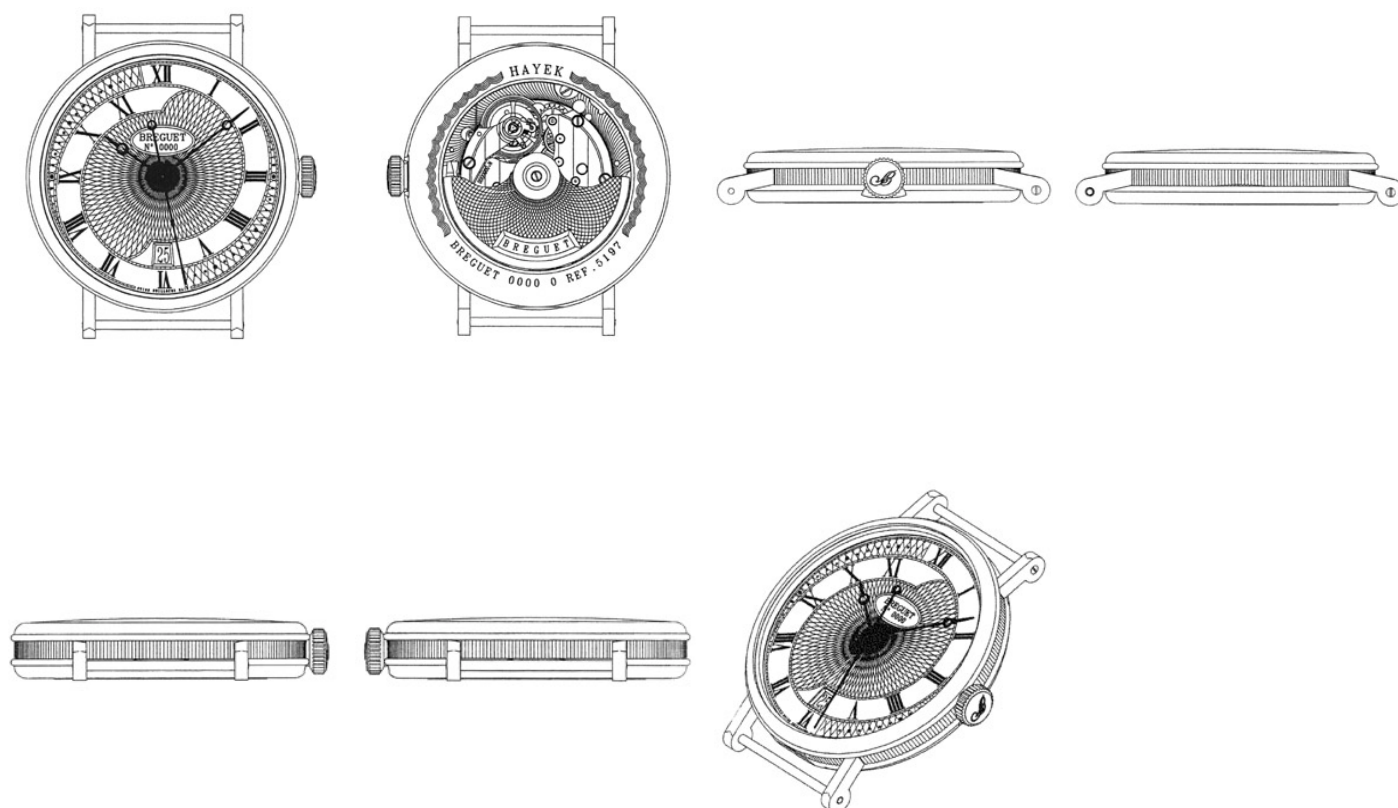

(11) Rahvusvah reg nr	DM/066993	(51) Klass: 10-02
(21) Rahvusvah reg jrk	H200500143	
(15) Registreeringu päev	14.09.2005	
(22) Esitamise päev	14.09.2005	
(28) Variantide arv	1	
(72) Autor	Walter GARRO, SWATCHLAB, Via Archimede 6, IT-20129 MILANO, IT	
(73) Omanik	SWATCH AG (SWATCH SA) (SWATCH LTD.), 94, Rue Jakob Stämpfli, CH-2502 BIENNE, CH	
WIPO Rahvusvah Tööstusdisainilahenduste Bületääni nr, kus registreering on avaldatud	2005/09	

(54) **Nimetus** **Wristwatch**

(55) **Reproduksioon**

DM/066993-01



(11) Rahvusvah reg nr	DM/066994	(51) Klass: 10-07
(21) Rahvusvah reg jrk	H200500144	
(15) Registreeringu päev	14.09.2005	
(22) Esitamise päev	14.09.2005	
(28) Variantide arv	1	
(72) Autor	Walter GARRO, SWATCHLAB, Via Archimede 6, IT-20129 MILANO, IT	
(73) Omanik	SWATCH AG (SWATCH SA) (SWATCH LTD.), 94, Rue Jakob Stämpfli, CH-2502 BIENNE, CH	
WIPO Rahvusvah Tööstusdisainilahenduste Bülletääni nr, kus registreering on avaldatud	2005/09	

(54) **Nimetus** **Watch strap**

(55) **Reproduktsoon**

DM/066994-01



(11) Rahvusvah reg nr	DM/067017	(51) Klass: 10-02
(21) Rahvusvah reg jrk	H200500145	
(15) Registreeringu päev	21.09.2005	
(22) Esitamise päev	21.09.2005	
(28) Variantide arv	1	
(72) Autor	Adelina Bissola, SWATCHLAB, via Archimede 6, I-20129 MILANO, IT	
(73) Omanik	SWATCH AG (SWATCH SA) (SWATCH LTD.), 94, Rue Jakob Stämpfli, CH-2502 BIENNE, CH	
WIPO Rahvusvah Tööstusdisainilahenduste Bülettääni nr, kus registreering on avaldatud	2005/09	

(54) **Nimetus** **Wrist watch**

(55) **Reproduktsoon**

DM/067017-01



(11) Rahvusvah reg nr	DM/067051	(51) Klass: 10-02
(21) Rahvusvah reg jrk	H200500146	
(15) Registreeringu päev	02.09.2005	
(22) Esitamise päev	02.09.2005	
(28) Variantide arv	1	
(72) Autor	Léonie COCQUIO, DUPONT DESIGN SA, Route des Jeunes 33, CH-1227 CAROUGE, CH	
(73) Omanik	SWATCH AG (SWATCH SA) (SWATCH LTD.), 94, Rue Jakob Stämpfli, CH-2502 BIENNE, CH	

**WIPO Rahvusvah Tööstusdisainilahenduste
Bülletääni nr, kus registreering on avaldatud** 2005/09

(54) **Nimetus** **Wristwatch**

(55) **Reproduktsoon**

DM/067051-01



(11) Rahvusvah reg nr	DM/067052	(51) Klass: 10-02
(21) Rahvusvah reg jrk	H200500147	
(15) Registreeringu päev	02.09.2005	
(22) Esitamise päev	02.09.2005	
(28) Variantide arv	1	
(72) Autor	Arnaud BLASZCZYK, DUPONT DESIGN SA, Route des Jeunes 33, CH-2502 BIENNE, CH	
(73) Omanik	SWATCH AG (SWATCH SA) (SWATCH LTD.), 94, Rue Jakob Stämpfli, CH-2502 BIENNE, CH	

**WIPO Rahvusvah Tööstusdisainilahenduste
Bülletääni nr, kus registreering on avaldatud** 2005/09

(54) **Nimetus** **Wristwatch**

(55) **Reproduktsoon**

DM/067052-01



(11) Rahvusvah reg nr	DM/067053	(51) Klass: 10-02
(21) Rahvusvah reg jrk	H200500148	
(15) Registreeringu päev	02.09.2005	
(22) Esitamise päev	02.09.2005	
(28) Variantide arv	1	
(72) Autor	Malcolm DRAGOTTA, SWATCHLAB, Via Archimede 6, IT-20129 Milano, IT	
(73) Omanik	SWATCH AG (SWATCH SA) (SWATCH LTD.), 94, Rue Jakob Stämpfli, CH-2502 BIENNE, CH	
WIPO Rahvusvah Tööstusdisainilahenduste Bülletääni nr, kus registreering on avaldatud	2005/09	

(54) **Nimetus** **Wristwatch**

(55) **Reproduksioon**

DM/067053-01



(11) Rahvusvah reg nr	DM/067054	(51) Klass: 10-02
(21) Rahvusvah reg jrk	H200500149	
(15) Registreeringu päev	02.09.2005	
(22) Esitamise päev	02.09.2005	
(28) Variantide arv	1	
(72) Autor	Alain GRUBER, LAUFWERK GmbH, Fabrikstrasse 12, CH-3012 BERN, CH	
(73) Omanik	SWATCH AG (SWATCH SA) (SWATCH LTD.), 94, Rue Jakob Stämpfli, CH-2502 BIENNE, CH	

**WIPO Rahvusvah Tööstusdisainilahenduste
Bülletääni nr, kus registreering on avaldatud** 2005/09

(54) **Nimetus** **Wristwatch**

(55) **Reproduktsoon**

DM/067054-01



(11) Rahvusvah reg nr	DM/067057	(51) Klass: 10-02
(21) Rahvusvah reg jrk	H200500150	
(15) Registreeringu päev	02.09.2005	
(22) Esitamise päev	02.09.2005	
(28) Variantide arv	1	
(72) Autor	Adelina BISSOLO, SWATCHLAB, Via Archimede 6, IT-20129 MILANO, IT	
(73) Omanik	SWATCH AG (SWATCH SA) (SWATCH LTD.), 94, Rue Jakob Stämpfli, CH-2502 BIENNE, CH	

**WIPO Rahvusvah Tööstusdisainilahenduste
Bülletääni nr, kus registreering on avaldatud** 2005/09

(54) **Nimetus** **Wristwatch**

(55) **Reproduksioon**

DM/067057-01



(11) Rahvusvah reg nr	DM/067058	(51) Klass: 10-02
(21) Rahvusvah reg jrk	H200500151	
(15) Registreeringu päev	02.09.2005	
(22) Esitamise päev	02.09.2005	
(28) Variantide arv	1	
(72) Autor	Danilo SALA, SWATCHLAB, Via Archimede 6, I-20129 MILANO, IT	
(73) Omanik	SWATCH AG (SWATCH SA) (SWATCH LTD.), 94, Rue Jakob Stämpfli, CH-2502 BIENNE, CH	
WIPO Rahvusvah Tööstusdisainilahenduste Bülletääni nr, kus registreering on avaldatud	2005/09	

(54) **Nimetus** **Wristwatch**

(55) **Reproduktsoon**

DM/067058-01



III. REGISTREERINGU KEHTIVUSE PIKENDAMINE

(11)	(18)		
00546	26.03.2011	00560	26.03.2011
00547	26.03.2011	00561	26.03.2011
00548	26.03.2011	00562	07.05.2011
00549	05.03.2011	00564	08.03.2011
00550	05.03.2011	00585	03.04.2011
00555	24.04.2011	00594	27.09.2011
00556	24.04.2011		

IV. TÖÖSTUSDISAINILAHENDUSE ÜLEMINEK

Reg nr	Uue omaniku andmed	Registrikande jõustumise päev
00691	Nemiroff Intellectual Property Establishment, Haus Rechsteiner, P.O. Box 634/Städtle 31, LI-9490 Vaduz, LI	24.03.2006

VI. MUUD REGISTREERINGU ANDMETE MUUDATUSED

Reg nr	Muudetud andmed	Registrikande jõustumise päev
00731	AS Tallinna Karastusjoogid, Silikaltsiidi 3, 11216 Tallinn, EE	08.03.2006
01131	Wei-Jong William Sheu, 7852 Vicky Avenue, West Hills, CA 91304, US	15.02.2006
01136	Chun-Wei Su	15.03.2006
01137	Eero Kiipli, Sütiste tee 44-61, 13420 Tallinn, EE Allan Kiipli, Sütiste tee 44-61, 13420 Tallinn, EE	15.02.2006

XI. TÖÖSTUSDISAINILAHENDUSE KUSTUTAMINE REGISTRIST

"Tööstusdisaini kaitse seaduse" paragrahvi 77 lõike 1 alusel on registrist kustutatud järgmised tööstusdisainilahendused:

Reg nr	Kustutamise jõustumise päev
--------	-----------------------------

00477	08.08.2005	00495	29.08.2005	00516	18.10.2005
00484	26.07.2005	00496	29.08.2005	00517	18.10.2005
00489	29.08.2005	00497	15.09.2005	00518	18.10.2005
00490	29.08.2005	00499	29.08.2005	00519	18.10.2005
00491	29.08.2005	00500	29.08.2005	00563	18.10.2005
00492	29.08.2005	00501	31.08.2005	01085	11.04.2006
00493	29.08.2005	00514	18.10.2005		
00494	29.08.2005	00515	18.10.2005		

XII. LOENDID

REGISTREERITUD TÖÖSTUSDISAINILAHENDUSTE SÜSTEMAATILINE LOEND

Rahvusvahelise klassifikatsiooni klass ja alaklass(id)	Registreerimis-taotluse number	Registreeringu number
--	--------------------------------	-----------------------

02-02	D200600008	01157	11-02	D200500056I	01147
02-06	D200600009	01158	11-02	D200500056J	01148
06-03	D200600001	01152	14-01	D200500090	01149
06-03	D200600004	01154	14-01	D200500091	01150
06-09	D200600005	01155	14-01	D200500092	01151
07-02	D200600005	01155	14-01	D200600014	01163
07-08	D200500092	01151	14-02	D200500090	01149
09-01	D200600006	01156	14-02	D200500091	01150
09-02	D200600003	01153	14-02	D200600014	01163
09-03	D200600011	01161	14-03	D200500078	01159
11-02	D200500056	01139	14-03	D200500091	01150
11-02	D200500056A	01140	14-03	D200600014	01163
11-02	D200500056B	01141	23-02	D200500076	01160
11-02	D200500056C	01142	23-03	D200500090	01149
11-02	D200500056D	01143	23-03	D200500091	01150
11-02	D200500056F	01144	23-03	D200500092	01151
11-02	D200500056G	01145	25-01	D200500090	01149
11-02	D200500056H	01146	25-03	D200600013	01162

REGISTREERITUD TÖÖSTUSDISAINILAHENDUSTE REGISTREERIMISTAOTLUSTE NUMBRILINE LOEND

Registreerimis-taotluse number	Registreeringu number	Rahvusvahelise klassifikatsiooni klass(id) ja alaklass(id)
--------------------------------	-----------------------	--

D200500056	01139	11-02	D200500091	01150	14-03
D200500056A	01140	11-02	D200500091	01150	23-03
D200500056B	01141	11-02	D200500092	01151	07-08
D200500056C	01142	11-02	D200500092	01151	14-01
D200500056D	01143	11-02	D200500092	01151	23-03
D200500056F	01144	11-02	D200600001	01152	06-03
D200500056G	01145	11-02	D200600003	01153	09-02
D200500056H	01146	11-02	D200600004	01154	06-03
D200500056I	01147	11-02	D200600005	01155	06-09
D200500056J	01148	11-02	D200600005	01155	07-02
D200500076	01160	23-02	D200600006	01156	09-01
D200500078	01159	14-03	D200600008	01157	02-02
D200500090	01149	14-01	D200600009	01158	02-06
D200500090	01149	14-02	D200600011	01161	09-03
D200500090	01149	23-03	D200600013	01162	25-03
D200500090	01149	25-01	D200600014	01163	14-01
D200500091	01150	14-01	D200600014	01163	14-02
D200500091	01150	14-02	D200600014	01163	14-03

AVALDATUD RAHVUSVAHELISE REGISTREERINGU REGISTREERIMISE OTSUSE TEADETE NUMBRILINE LOEND

DM/066091	DM/066383	DM/066522	DM/066808	DM/066864	DM/067052
DM/066092	DM/066384	DM/066560	DM/066810	DM/066865	DM/067053
DM/066093	DM/066407	DM/066573	DM/066811	DM/066867	DM/067054
DM/066094	DM/066424	DM/066648	DM/066812	DM/066874	DM/067057
DM/066095	DM/066463	DM/066792	DM/066855	DM/066993	DM/067058
DM/066161	DM/066464	DM/066803	DM/066860	DM/066994	
DM/066381	DM/066465	DM/066805	DM/066861	DM/067017	
DM/066382	DM/066522	DM/066806	DM/066863	DM/067051	

XIII. TÖÖSTUSDISAINIALASED ÕIGUSAKTID JA MUU INFO**RIIKLIKUS PATENDIVOLINIKE REGISTRIS REGISTREERITUD PATENDIVOLINIKE NIMEKIRI**
(seisuga 23. detsember 2005)

Register on asutatud 1. septembril 2001. a Vabariigi Valitsuse 7. augusti 2001. a määrusega nr 271 "Riikliku patendivolinike registri asutamine ja registri pidamise põhimäärus" (RT I 2001, 70, 426) patendivoliniku seaduse § 21 alusel (RT I 2001, 27, 151).

TEGEVUSVALDKOND: KAUBAMÄRK, TÖÖSTUSDISAINILAHENDUS JA GEOGRAAFILINE TÄHIS

- | | | | |
|------------------------------|---|-----------------------|---|
| Arno ANIJALG | OÜ USTERVALL
Raekoja plats 16
51004 Tartu
pk 21, 50002 Tartu
telefon: 744 1980
telefaks: 744 1785
e-post: anijalg@ustervall.ee
http://www.ustervall.ee
võõrkeeled: saksa, vene | Juhan HÄMMALOV | OÜ Intels
Riia 11-3
51010 Tartu
telefon: 742 0401
telefaks: 742 0326
e-post: intelses@estpak.ee
võõrkeeled: inglise, saksa, vene |
| Aivo ARULA | Patendibüroo Käosaar & Co OÜ
Tähe 94
50107 Tartu
telefon: 738 3051
telefaks: 738 3055
e-post: info@kaosaar.ee
http://www.kaosaar.ee
võõrkeeled: inglise, vene | Uno JÄÄGER | Inseneribüroo Uneko OÜ
Rüütli 51a, 80010 Pärnu
telefon: 447 1021
telefaks: 447 1001
GSM: 515 1844
e-post: uno@estpak.ee
võõrkeeled: inglise, soome, vene |
| Martina BÖCKLER-LORVI | OÜ LASVET
Suurtüki 4a, 10133 Tallinn
pk 3136, 10505 Tallinn
telefon: 640 6600
telefaks: 640 6604
e-post: lasvet@lasvet.ee
http://www.lasvet.ee
võõrkeeled: inglise, soome | Sirje KAHU | OÜ USTERVALL
Raekoja plats 16
51004 Tartu
pk 21, 50002 Tartu
telefon: 744 1980
telefaks: 744 1785
e-post: skahu@ustervall.ee
http://www.ustervall.ee
võõrkeeled: inglise, vene |
| Indrek EELMETS | OÜ LASVET
Suurtüki 4a, 10133 Tallinn
pk 3136, 10505 Tallinn
telefon: 640 6600
telefaks: 640 6604
e-post: lasvet@lasvet.ee
http://www.lasvet.ee
võõrkeeled: inglise, vene, soome | Lembit KALEV | Patendibüroo ROOSILLA OÜ
Järveotsa tee 39-61
13520 Tallinn
telefon: 657 1722, 657 5381
telefaks: 657 5381
GSM: 511 9951
e-post: roosilla@roosilla.ee
http://www.roosilla.ee
võõrkeeled: inglise, vene |
| Alla HÄMMALOV | OÜ Intels
Riia 11-3
51010 Tartu
telefon: 742 0401
telefaks: 742 0326
e-post: intelses@estpak.ee
võõrkeeled: inglise, poola, vene | Anneli KANG | OÜ Synest
pk 977, 13402 Tallinn
telefon: 660 9786
telefaks: 660 9787
e-post: anneli@synest.ee
võõrkeeled: inglise, saksa, vene, prantsuse, soome, rootsi |

- Urmas KAULER** **Patendibüroo TURVAJA OÜ**
 Liivalaia 22
 10118 Tallinn
 telefon: 640 3109
 telefaks: 640 3105
 e-post: kauler@turvaja.ee
 http://www.turvaja.ee
 võõrkeeled: inglise, vene, soome
- Urmas KERNU** **AAA Patendibüroo OÜ**
 Tartu mnt 16
 10117 Tallinn
 pk 3926, 10509 Tallinn
 telefon: 660 5910, 660 5911
 telefaks: 660 5912
 e-post: aaa@aaa.ee
 http://www.aaa.ee
 võõrkeeled: inglise, saksa, soome, vene
- Ljubov KESSELMAN** **OÜ Kesna**
 Tedre 77-52
 10616 Tallinn
 telefon: 660 8068
 telefaks: 660 8069
 e-post: kesna@online.ee
 võõrkeeled: inglise, vene
- Marina KESSELMAN** **OÜ Kesna**
 Tedre 77-52
 10616 Tallinn
 telefon: 660 8068
 telefaks: 660 8069
 e-post: kesna@online.ee
 võõrkeeled: inglise, saksa, vene
- Heinu KOITEL** **Patendi- & Kaubamärgibüroo Koitel OÜ**
 Tartu mnt 65
 10115 Tallinn
 pk 1759, 10902 Tallinn
 telefon: 603 3260
 telefaks: 603 3261
 e-post: koitel@koitel.ee
 http://www.koitel.ee
 võõrkeeled: inglise, soome, vene
- Raivo KOITEL** **Patendi- & Kaubamärgibüroo Koitel OÜ**
 Tartu mnt 65
 10115 Tallinn
 pk 1759, 10902 Tallinn
 telefon: 603 3260
 telefaks: 603 3261
 e-post: koitel@koitel.ee
 http://www.koitel.ee
 võõrkeeled: inglise, soome, vene
- Mart Enn KOPPEL** **Patendibüroo Koppel OÜ**
 Kajaka 4-10
 11317 Tallinn
 telefon: 677 4136
 telefaks: 677 4138
 e-post: info@koppelpb.com
 http://www.koppelpb.com
 võõrkeeled: inglise, vene, soome
- Heinrich KRUPP** **Patendibüroo TURVAJA OÜ**
 Liivalaia 22
 10118 Tallinn
 telefon: 640 3109
 telefaks: 640 3105
 e-post: turvaja@turvaja.ee
 http://www.turvaja.ee
 võõrkeeled: saksa, vene
- Jüri KÄOSAAR** **Patendibüroo Käosaar & Co OÜ**
 Tähe 94
 50107 Tartu
 telefon: 738 3051
 telefaks: 738 3055
 e-post: info@kaosaar.ee
 http://www.kaosaar.ee
 võõrkeeled: inglise, vene
- Kalev KÄOSAAR** **Patendibüroo Käosaar & Co OÜ**
 Peterburi tee 46
 11415 Tallinn
 telefon: 637 9484
 telefaks: 637 9485
 e-post: kalev.kaosaar@kaosaar.ee
 http://www.kaosaar.ee
 võõrkeeled: inglise, vene
- Reet MAASIKAMÄE** **OÜ Kaitsepurus**
 Mulla 4-3
 10611 Tallinn
 telefon: 673 9097, 633 2798
 telefaks: 677 4844
 e-post: purus@online.ee
 purus@hot.ee
 http://www.hot.ee/purus/
 võõrkeeled: inglise, vene
- Raivo MATSOO** **RM Hirvela Patendibüroo OÜ**
 Saku 15, 11314 Tallinn
 telefon: 614 0816
 telefaks: 614 0818
 e-post: hirvela@hirvela.ee
 võõrkeeled: inglise, vene

- Elle MELLIK** **AAA Patendibüroo OÜ**
Tartu mnt 16
10117 Tallinn
pk 3926, 10509 Tallinn
telefon: 660 5910, 660 5911
telefaks: 660 5912
e-post: aaa@aaa.ee
http://www.aaa.ee
võõrkeeled: inglise, vene
- Lembit MITT** **AAA Patendibüroo OÜ**
Tartu mnt 16
10117 Tallinn
pk 3926, 10509 Tallinn
telefon: 660 5910, 660 5911
telefaks: 660 5912
e-post: aaa@aaa.ee
http://www.aaa.ee
võõrkeeled: inglise, vene
- Ott MOORLAT** **OÜ Moorlat & Ko
Patendibüroo**
pk 723, 12902 Tallinn
telefon: 655 0450, 654 2844
telefaks: 654 2844
e-post: ott.moorlat@moorlat.ee
http://www.moorlat.ee
võõrkeeled: inglise, vene
- Anfia MORNA** **Patendibüroo TURVAJA OÜ**
Liivalaia 22, 10118 Tallinn
telefon: 640 3109
telefaks: 640 3105
e-post: morna@turvaja.ee
http://www.turvaja.ee
võõrkeeled: inglise, vene
- Tõnu NELNAS** **AAA Patendibüroo OÜ**
Tartu mnt 16
10117 Tallinn
pk 3926, 10509 Tallinn
telefon: 660 5910, 660 5911
telefaks: 660 5912
e-post: aaa@aaa.ee
http://www.aaa.ee
võõrkeeled: inglise, vene, soome
- Jüri OLT** **Patendibüroo Käosaar & Co
OÜ**
Tähe 94, 50107 Tartu
telefon: 738 3051
telefaks: 738 3055
e-post: info@kaosaar.ee
http://www.kaosaar.ee
võõrkeeled: inglise, saksa,
soome, vene
- Jaak OSTRAT**
- Villu PAVELTS**
- Toom PUNGAS**
- Kaie PUUR**
- Riina PÄRN**
- Tarmo ROSMAN**
- Arvo SALUMÄE**
- OÜ LASVET**
Suurtüki 4a, 10133 Tallinn
pk 3136, 10505 Tallinn
telefon: 640 6600
telefaks: 640 6604
e-post: lasvet@lasvet.ee
http://www.lasvet.ee
võõrkeeled: inglise, saksa,
soome, vene
- OÜ LASVET**
Suurtüki 4a, 10133 Tallinn
pk 3136, 10505 Tallinn
telefon: 640 6600
telefaks: 640 6604
e-post: lasvet@lasvet.ee
http://www.lasvet.ee
võõrkeeled: inglise, soome, vene
- OÜ Synest**
pk 977, 13402 Tallinn
telefon: 660 9786
telefaks: 660 9787
e-post: toom@synest.ee
võõrkeeled: inglise, saksa,
soome, vene
- Patendibüroo Käosaar & Co
OÜ**
Tähe 94
50107 Tartu
telefon: 738 3051
telefaks: 738 3055
e-post: info@kaosaar.ee
http://www.kaosaar.ee
võõrkeeled: inglise, vene
- OÜ Intels**
Riia 11-3
51010 Tartu
telefon: 742 0401
telefaks: 742 0326
e-post: intelses@estpak.ee
võõrkeeled: inglise, vene
- Rosman ja Partnerid OÜ**
pk 652, 12602 Tallinn
telefon: 656 1450
telefaks: 656 1450
e-post: tarman@cc.ttu.ee
võõrkeeled: saksa, inglise, ungari,
vene
- OÜ Amende Patendibüroo**
Raua 65
10152 Tallinn
telefon: 648 6125
telefaks: 641 0174
e-post: amende@hot.ee
võõrkeeled: inglise, saksa, soome,
vene

Almar SEHVER**AAA Patendibüroo OÜ**

Tartu mnt 16
10117 Tallinn
pk 3926, 10509 Tallinn
telefon: 660 5910, 660 5911
telefaks: 660 5912
e-post: aaa@aaa.ee
<http://www.aaa.ee>
võõrkeeled: inglise, vene

Olga TREUFELDT**Patendibüroo TURVAJA OÜ**

Liivalaia 22
10118 Tallinn
telefon: 640 3109
telefaks: 640 3105
e-post: olga@turvaja.ee
<http://www.turvaja.ee>
võõrkeeled: inglise, vene

Harald TEHVER**Patendibüroo TURVAJA OÜ**

Liivalaia 22
10118 Tallinn
telefon: 640 3109
telefaks: 640 3105
e-post: tehver@turvaja.ee
<http://www.turvaja.ee>
võõrkeeled: inglise, saksa, vene

Enn URGAS**Patendibüroo TURVAJA OÜ**

Liivalaia 22
10118 Tallinn
telefon: 640 3109
telefaks: 640 3105
e-post: urgas@turvaja.ee
<http://www.turvaja.ee>
võõrkeeled: inglise, vene

Mari TOOMSOO**Patendibüroo Käosaar & Co OÜ**

Peterburi tee 46, 11415 Tallinn
telefon: 637 9484
telefaks: 637 9485
e-post: mari.toomsoo@kaosaar.ee
<http://www.kaosaar.ee>
võõrkeeled: inglise, soome

Juta-Maris UUSTALU**OÜ Amende Patendibüroo**

Raua 65
10152 Tallinn
telefon: 648 6125
telefaks: 641 0174
e-post: amende@hot.ee
võõrkeeled: inglise, vene

**LIST OF PATENT ATTORNEYS, REGISTERED IN
THE ESTONIAN STATE REGISTER OF PATENT ATTORNEYS**
(by 23 December 2005)

Register is established on September 1st 2001

FIELD OF ACTIVITY: TRADEMARKS, INDUSTRIAL DESIGNS AND GEOGRAPHICAL INDICATIONS

Arno ANIJALG	USTERVALL Ltd. Raekoja plats 16 51004 Tartu, Estonia P.O. Box 21 50002 Tartu, Estonia Phone: +372 744 1980 Fax: +372 744 1785 E-mail: anijalg@ustervall.ee Http://www.ustervall.ee German, Russian, Estonian	Juhan HÄMMALOV	Intels Ltd. Riia Str. 11-3 51010 Tartu, Estonia Phone: +372 742 0401 Fax: +372 742 0326 E-mail: intelses@estpak.ee English, German, Russian, Estonian
Aivo ARULA	Patent Agency Käosaar & Co Tähe Str. 94 50107 Tartu, Estonia Phone: +372 738 3051 Fax: +372 738 3055 E-mail: info@kaosaar.ee Http://www.kaosaar.ee English, Russian, Estonian	Uno JÄÄGER	Inseneribüroo Uneko Ltd. Rüütli 51a 80010 Pärnu, Estonia Phone: +372 447 1021 Fax: +372 447 1001 GSM: +372 515 1844 E-mail: uno@estpak.ee English, Finnish, Russian, Estonian
Martina BÖCKLER-LORVI	Lasvet Ltd. P.O. Box 3136 10505 Tallinn, Estonia Phone: +372 640 6600 Fax: +372 640 6604 E-mail: lasvet@lasvet.ee Http://www.lasvet.ee English, Finnish, Estonian	Sirje KAHU	USTERVALL Ltd. Raekoja plats 16 51004 Tartu, Estonia P.O. Box 21 50002 Tartu, Estonia Phone: +372 744 1980 Fax: +372 744 1785 E-mail: skahu@ustervall.ee Http://www.ustervall.ee English, Russian, Estonian
Indrek EELMETS	Lasvet Ltd. P.O. Box 3136 10505 Tallinn, Estonia Phone: +372 640 6600 Fax: +372 640 6604 E-mail: lasvet@lasvet.ee Http://www.lasvet.ee English, Finnish, Russian, Estonian	Lembit KALEV	Patent Bureau ROOSILLA Ltd. Järveotsa Road 39-61 13520 Tallinn, Estonia Phone: +372 657 1722 +372 657 5381 Fax: +372 657 5381 GSM: +372 511 9951 E-mail: roosilla@roosilla.ee Http://www.roosilla.ee English, Russian, Estonian
Alla HÄMMALOV	Intels Ltd. Riia Str. 11-3 51010 Tartu, Estonia Phone: +372 742 0401 Fax: +372 742 0326 E-mail: intelses@estpak.ee English, Polish, Russian, Estonian	Anneli KANG	Synest Ltd. P.O. Box 977 13402 Tallinn, Estonia Phone: +372 660 9786 Fax: +372 660 9787 E-mail: anneli@synest.ee English, German, Russian, French, Finnish, Swedish, Estonian

Urmast KAULER	Patendibüroo TURVAJA OÜ Liivalaia 22 10118 Tallinn, Estonia Phone: +372 640 3109 Fax: +372 640 3105 E-mail: kauler@turvaja.ee Http://www.turvaja.ee English, Russian, Finnish, Estonian	Raivo KOITEL	Patent & Trademark Agency Koitel Tartu Road 65 10115 Tallinn, Estonia P.O. Box 1759 10902 Tallinn, Estonia Phone: +372 603 3260 Fax: +372 603 3261 E-mail: koitel@koitel.ee Http://www.koitel.ee English, Finnish, Russian, Estonian
Urmast KERNU	AAA Legal Services Tartu Road 16 10117 Tallinn, Estonia P.O. Box 3926 10509 Tallinn, Estonia Phone: +372 660 5910 +372 660 5911 Fax: +372 660 5912 E-mail: aaa@aaa.ee Http://www.aaa.ee English, German, Finnish, Russian, Estonian	Mart Enn KOPPEL	Patent Bureau Koppel Kajaka 4-10 11317 Tallinn, Estonia Phone: +372 677 4136 Fax: +372 677 4138 E-mail: info@koppelpb.com Http://www.koppelpb.com English, Russian, Finnish, Estonian
Marina KESSELMAN	Kesna Ltd. Tedre Str. 77-52 10616 Tallinn, Estonia Phone: +372 660 8068 Fax: +372 660 8069 E-mail: kesna@online.ee English, German, Russian, Estonian	Heinrich KRUPP	Patendibüroo TURVAJA OÜ Liivalaia 22 10118 Tallinn, Estonia Phone: +372 640 3109 Fax: +372 640 3105 E-mail: turvaja@turvaja.ee Http://www.turvaja.ee German, Russian, Estonian
Ljubov KESSELMAN	Kesna Ltd. Tedre Str. 77-52 10616 Tallinn, Estonia Phone: +372 660 8068 Fax: +372 660 8069 E-mail: kesna@online.ee English, Russian, Estonian	Jüri KÄOSAAR	Patent Agency Käosaar & Co Tähe Str. 94 50107 Tartu, Estonia Phone: +372 738 3051 Fax: +372 738 3055 E-mail: info@kaosaar.ee Http://www.kaosaar.ee English, Russian, Estonian
Heinu KOITEL	Patent & Trademark Agency Koitel Tartu Road 65 10115 Tallinn, Estonia P.O. Box 1759 10902 Tallinn, Estonia Phone: +372 603 3260 Fax: +372 603 3261 E-mail: koitel@koitel.ee Http://www.koitel.ee English, Finnish, Russian, Estonian	Kalev KÄOSAAR	Patent Agency Käosaar & Co Peterburi Road 46 11415 Tallinn, Estonia Phone: +372 637 9484 Fax: +372 637 9485 E-mail: kalev.kaosaar@kaosaar.ee Http://www.kaosaar.ee English, Russian, Estonian

- Reet MAASIKAMÄE Patent Bureau Kaitsepurus Ltd.**
Mulla Str. 4-3
10611 Tallinn, Estonia
Phone: +372 673 9097
+372 633 2798
Fax: +372 677 4844
E-mail: purus@online.ee
purus@hot.ee
Http://www.hot.ee/purus/
English, Russian, Estonian
- Raivo MATSOO RM Hirvela Patent Bureau Ltd**
Saku 15, 11314 Tallinn, Estonia
Phone: +372 614 0816
Fax: +372 614 0818
E-mail: hirvela@hirvela.ee
English, Russian, Estonian
- Elle MELLIK AAA Legal Services**
Tartu Road 16
10117 Tallinn, Estonia
P.O. Box 3926
10509 Tallinn, Estonia
Phone: +372 660 5910
+372 660 5911
Fax: +372 660 5912
E-mail: aaa@aaa.ee
Http://www.aaa.ee
English, Russian, Estonian
- Lembit MITT AAA Legal Services**
Tartu Road 16
10117 Tallinn, Estonia
P.O. Box 3926
10509 Tallinn, Estonia
Phone: +372 660 5910
+372 660 5911
Fax: +372 660 5912
E-mail: aaa@aaa.ee
Http://www.aaa.ee
English, Russian, Estonian
- Ott MOORLAT Moorlat & Co Ltd. Patent Bureau**
P.O. Box 723
12902 Tallinn, Estonia
Phone: +372 655 0450
+372 654 2844
Fax: +372 654 2844
E-mail: ott.moorlat@moorlat.ee
Http://www.moorlat.ee
English, Russian, Estonian
- Anfia MORNA**
- Tõnu NELSAS**
- Jüri OLT**
- Jaak OSTRAT**
- Villu PAVELTS**
- Toom PUNGAS**
- Patendibüroo TURVAJA OÜ**
Liivalaia 22
10118 Tallinn, Estonia
Phone: +372 640 3109
Fax: +372 640 3105
E-mail: morna@turvaja.ee
Http://www.turvaja.ee
English, Russian, Estonian
- AAA Legal Services**
Tartu Road 16
10117 Tallinn, Estonia
P.O. Box 3926
10509 Tallinn, Estonia
Phone: +372 660 5910
+372 660 5911
Fax: +372 660 5912
E-mail: aaa@aaa.ee
Http://www.aaa.ee
English, Russian, Finnish, Estonian
- Patent Agency Käosaar & Co**
Tähe Str. 94
50107 Tartu, Estonia
Phone: +372 738 3051
Fax: +372 738 3055
E-mail: info@kaosaar.ee
Http://www.kaosaar.ee
English, German, Finnish, Russian, Estonian
- Lasvet Ltd.**
P.O. Box 3136
10505 Tallinn, Estonia
Phone: +372 640 6600
Fax: +372 640 6604
E-mail: lasvet@lasvet.ee
Http://www.lasvet.ee
English, German, Finnish, Russian, Estonian
- Lasvet Ltd.**
P.O. Box 3136
10505 Tallinn, Estonia
Phone: +372 640 6600
Fax: +372 640 6604
E-mail: lasvet@lasvet.ee
Http://www.lasvet.ee
English, Finnish, Russian, Estonian
- Synest Ltd.**
P.O. Box 977
13402 Tallinn, Estonia
Phone: +372 660 9786
Fax: +372 660 9787
E-mail: toom@synest.ee
English, German, Finnish, Russian, Estonian

- Kaie PUUR** **Patent Agency Käosaar & Co**
Tähe Str. 94
50107 Tartu, Estonia
Phone: +372 738 3051
Fax: +372 738 3055
E-mail: info@kaosaar.ee
Http://www.kaosaar.ee
English, Russian, Estonian
- Harald TEHVER** **Patendibüroo TURVAJA OÜ**
Liivalaia 22
10118 Tallinn, Estonia
Phone: +372 640 3109
Fax: +372 640 3105
E-mail: tehver@turvaja.ee
Http://www.turvaja.ee
English, German, Russian,
Estonian
- Riina PÄRN** **Intels Ltd.**
Riia Str. 11-3
51010 Tartu, Estonia
Phone: +372 742 0401
Fax: +372 742 0326
E-mail: intelses@estpak.ee
English, Russian,
Estonian
- Mari TOOMSOO** **Patent Agency Käosaar & Co**
Peterburi Str. 46
11415 Tallinn, Estonia
Phone: +372 637 9484
Fax: +372 637 9485
E-mail: mari.toomsoo@kaosaar.ee
Http://www.kaosaar.ee
English, Finnish, Estonian
- Tarmo ROSMAN** **Rosman and Partners Ltd.**
P.O. Box 652
12602 Tallinn, Estonia
Phone: +372 656 1450
Fax: +372 656 1450
E-mail: tarman@cc.ttu.ee
German, English, Hungarian,
Russian, Estonian
- Olga TREUFELDT** **Patendibüroo TURVAJA OÜ**
Liivalaia 22
10118 Tallinn, Estonia
Phone: +372 640 3109
Fax: +372 640 3105
E-mail: olga@turvaja.ee
Http://www.turvaja.ee
English, Russian, Estonian
- Arvo SALUMÄE** **AMENDE Patent Agency Ltd.**
Raua 65, 10152 Tallinn, Estonia
Phone: +372 648 6125
Fax: +372 641 0174
E-mail: amende@hot.ee
English, German, Finnish,
Russian, Estonian
- Enn URGAS** **Patendibüroo TURVAJA OÜ**
Liivalaia 22
10118 Tallinn, Estonia
Phone: +372 640 3109
Fax: +372 640 3105
E-mail: urgas@turvaja.ee
Http://www.turvaja.ee
English, Russian, Estonian
- Almar SEHVER** **AAA Legal Services**
Tartu Road 16
10117 Tallinn, Estonia
P.O. Box 3926
10509 Tallinn, Estonia
Phone: +372 660 5910
+372 660 5911
Fax: +372 660 5912
E-mail: aaa@aaa.ee
Http://www.aaa.ee
English, Russian, Estonian
- Juta-Maris UUSTALU** **AMENDE Patent Agency Ltd.**
Raua 65, 10152 Tallinn, Estonia
Phone: +372 648 6125
Fax: +372 641 0174
E-mail: amende@hot.ee
English, Russian, Estonian