

EVE VÄRV

MATEMAATIKA

TÖÖRAAMAT

1. KLASSILE

1. OSA

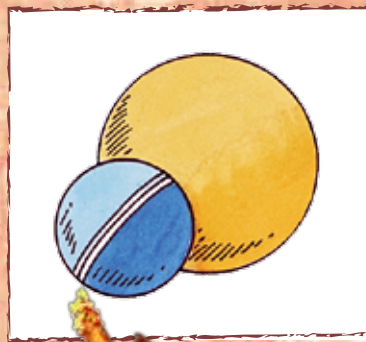

EVE VÄRV

MATEMAATIKA
TÖÖRAAMAT

1. KLASSILE

1. OSA

2014



Euroopa Liit
Euroopa Sotsiaalfond



Eesti tuleviku heaks



Hariduslike erivajadustega
õpilaste õppevara arendamine

Eve Värvi Matemaatika tööraamat 1. klassile. I osa

Tööraamat vastab põhikooli lihtsustatud riikliku õppekava lihtsustatud õppele

Tööraamatu koostamist konsulteeris *Meelika Maila*
Retsenseerinud *Merje Hendrikson, Tiiu Kaljas*

Toimetanud ja küljendanud *Tiina Helekivi*
Illustreerinud *Ülle Meister, Vilve Aavik-Vadi*
Kaane kujundanud *Eve Kurm*
Tehniliselt toimetanud *Andero Kurm*

Raamatu väljaandmist on toetanud Euroopa Sotsiaalfond ja Eesti riik programmi „Hariduslike erivajadustega õpilaste õppevara arendamine“ kaudu.

Programmi viib ellu SA Innove. 

Kõik õigused kaitstud. Igasugune autoriõigusega kaitstud materjali ebaseaduslik paljundamine ja levitamine toob kaasa seaduses ettenähtud vastutuse.

Autoriõigus: SA Innove, Eve Värvi, 2014

ISBN 978-9949-547-55-5 (kogu teos)
ISBN 978-9949-547-56-2 (kogu teos: pdf)
ISBN 978-9949-547-57-9 (I osa)
ISBN 978-9949-547-58-6 (I osa: pdf)
ISBN 978-9949-547-59-3 (II osa)
ISBN 978-9949-547-60-9 (II osa: pdf)
ISBN 978-9949-547-61-6 (III osa)
ISBN 978-9949-547-62-3 (III osa: pdf)

Trükiettevalmistus:
Kirjastus Studium
Riia 15b
Tartu 51010

Trükitud: OÜ Greif trükikojas
Lohkva, Luunja vald
Tartumaa 62207

SUUR – VÄIKE

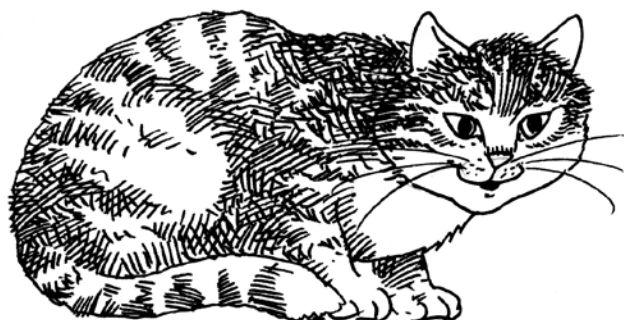
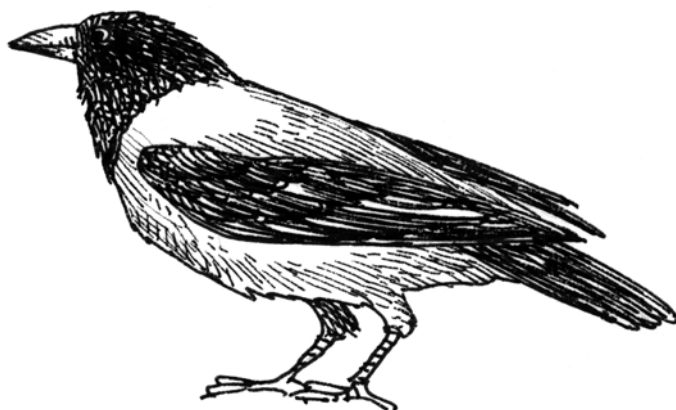
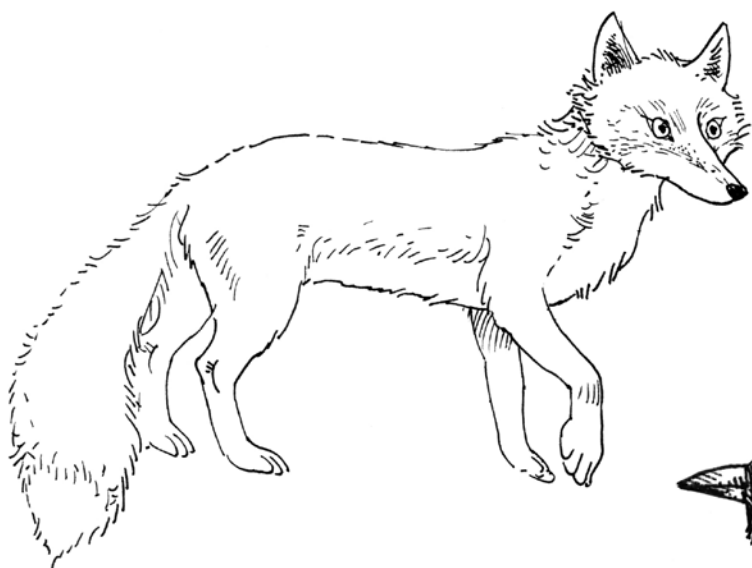

TÕMBA SUURELE PUNANE JA VÄIKSELE SININE JOON ÜMBER.

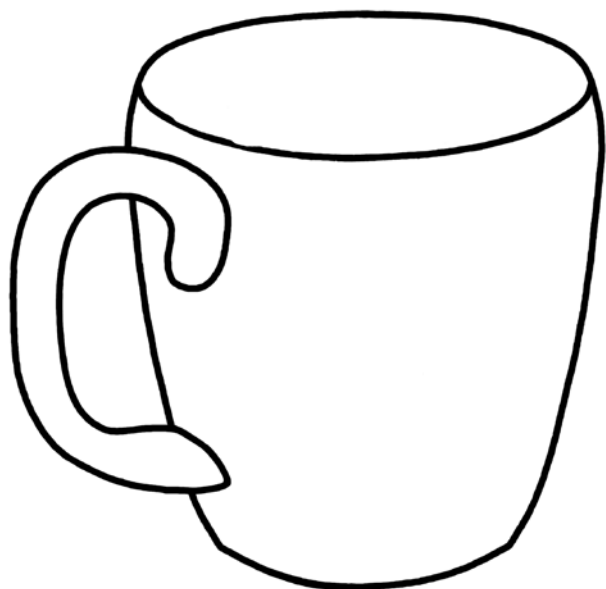

ÜHENDA JOONEGA SARNASED TASSID.
VÄRVI SARNASED TASSID SAMA VÄRVIGA.

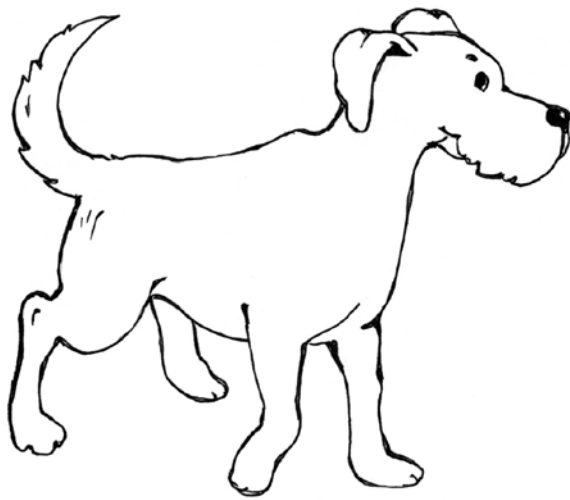

TÕMBA SUURELE KOERALE PUNANE JOON ÜMBER.
VÄRVI VÄIKE KOER.



ÜHENDA SARNASED JÄNESED JOONEGA.

VÄRVI SUURED JÄNESED PRUUNIKS JA VÄIKSED JÄNESED HALLIKS.

SUUREM – VÄIKSEM



VÄIKSEM

SUUREM

VÄRVI.

VÄIKE KOER ON MUST.

SUUR KOER ON PRUUN.

RÄÄGI.

VANAEMA KOER ON

TÜDRUKU KOER ON

VANAEMAL ON KOER.

TÜDRUKUL ON KOER.

SUUR

VÄIKE

VÄIKSEM

SUUREM



VÄRVI.

SUUR VIHMAVARI ON PUNANE.

VÄIKE VIHMAVARI ON KOLLANE.

VÖRDLE.

TÜDRUKUL ON VIHMAVARI KUI POISIL.

POISIL ON VIHMAVARI KUI TÜDRUKUL.

SUUREM

VÄIKSEM



VÄRVI.

SUUR ÕUN ON KOLLANE.

VÄIKE ÕUN ON PUNANE.

VÖRDLE.

KOLLANE ÕUN ON KUI PUNANE ÕUN.

PUNANE ÕUN ON KUI KOLLANE ÕUN.

SUUREM

VÄIKSEM

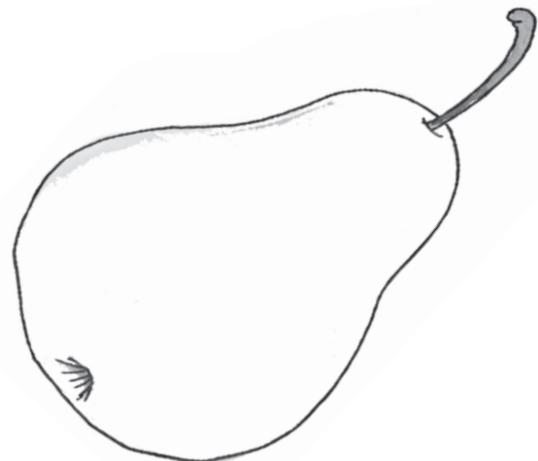

VÄRVI.

VÄIKE PIRN ON ROHELINE.

SUUR PIRN ON KOLLANE.

VÖRDLE.

KOLLANE PIRN ON KUI ROHELINE PIRN.

ROHELINE PIRN ON KUI KOLLANE PIRN.

SUUREM

VÄIKSEM

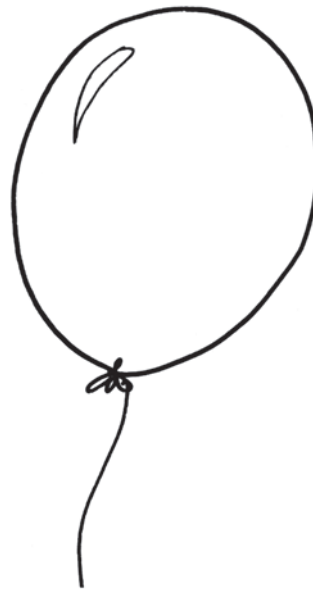
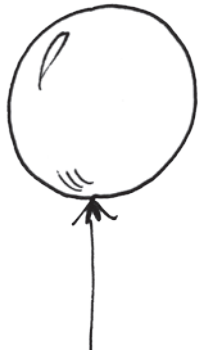

VÄRVI.

SUUR ÕHU+PALL ON SININE.

VÄIKE ÕHU+PALL ON ROHELINE.

VÖRDLE.

ROHELINE ÕHUPALL ON KUI SININE ÕHU+PALL.

SININE ÕHUPALL ON KUI ROHELINE ÕHU+PALL.

SUUREM

VÄIKSEM

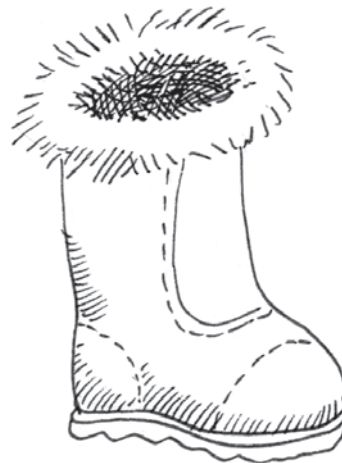

VÄRVI.

SUUR SAABAS ON PRUUN.

VÄIKE SAABAS ON KOLLANE.

VÖRDLE.

KOLLANE SAABAS ON KUI PRUUN SAABAS.

PRUUN SAABAS ON KUI KOLLANE SAABAS.

SUUREM

VÄIKSEM

ÜHESUURUSED



VÄRVI ÜHESUURUSED MAASIKAD PUNASEKS.

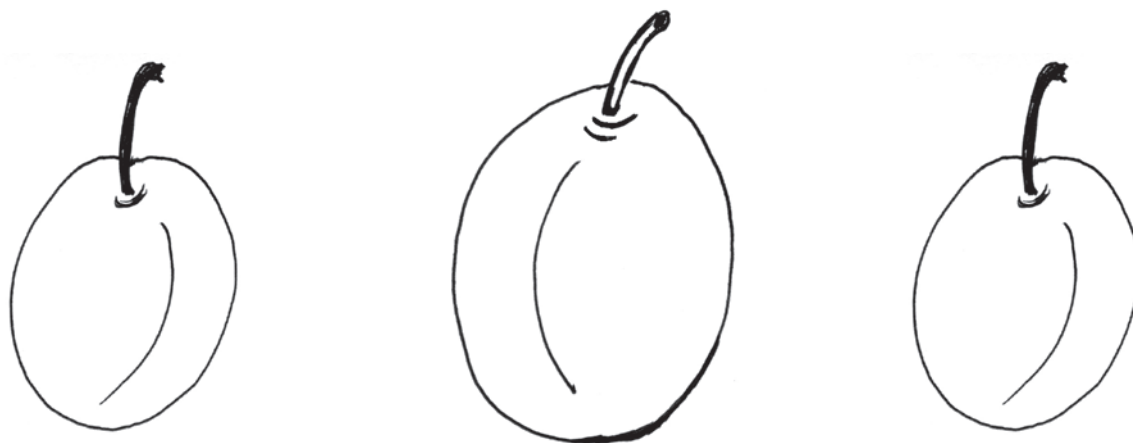

VÄRVI ÜHESUURUSED PLOOMID KOLLASEKS.



VÄRVI ÜHESUURUSED LEHED ROHELISEKS.



VÄRVI ÜHESUURUSED TOMATID KOLLASEKS.

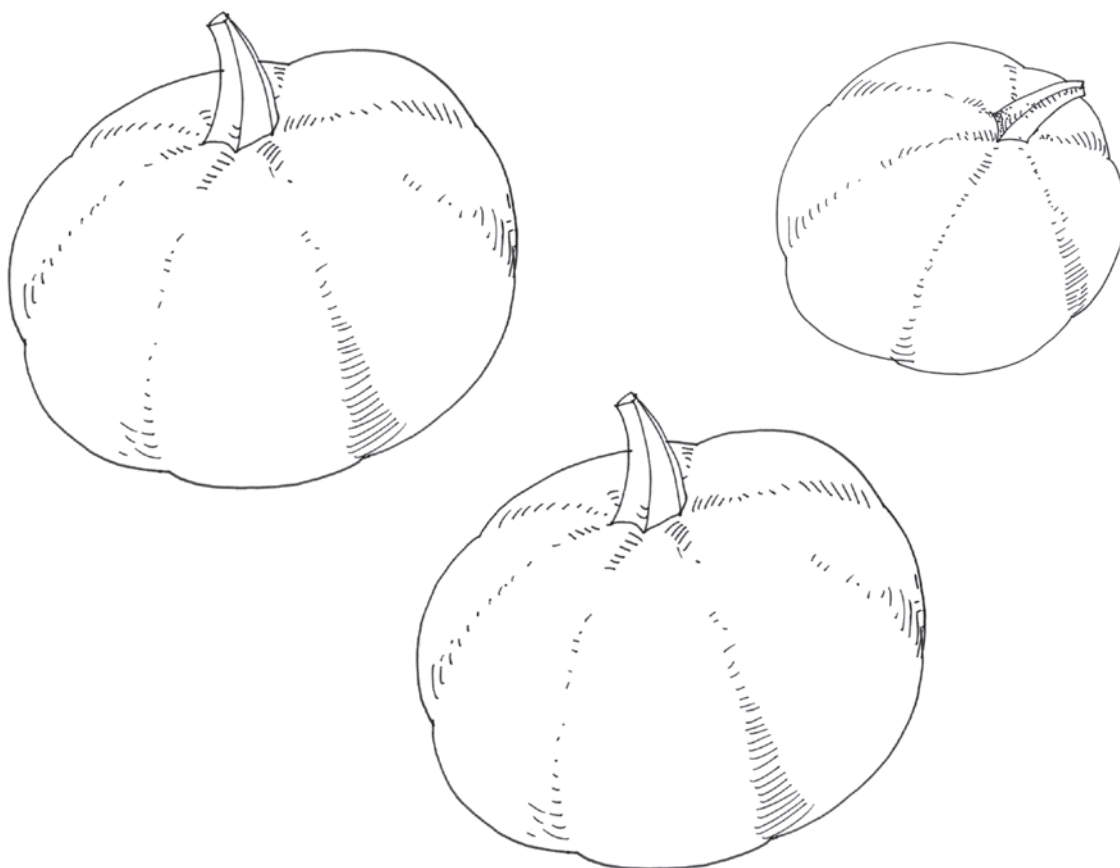

VÄRVI ÜHESUURUSED KÕRVITSAD ROHELISEKS.

PIKK – LÜHIKE

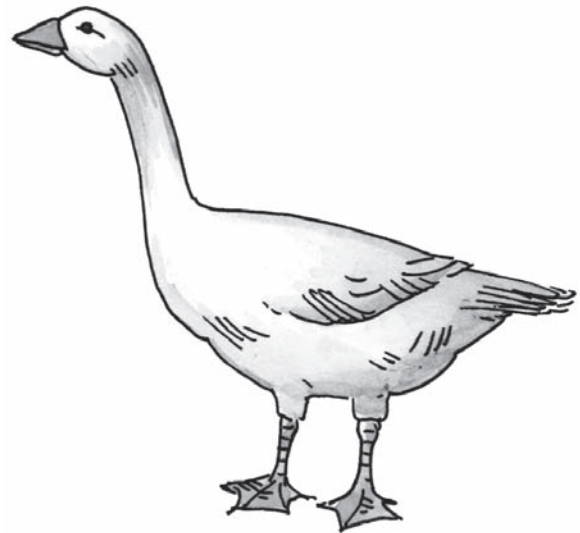
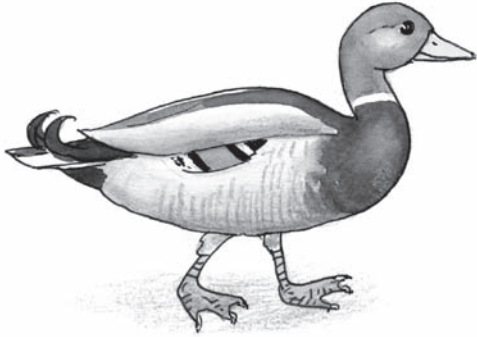

RÄÄGI.

HANEL ON KAEL.

PARDIL ON KAEL.

PIKK

LÜHIKE



VÄRVI.

PIKAD JUUKSED ON PRUUNID.

LÜHIKESED JUUKSED ON MUSTAD.

RÄÄGI.

POISIL ON JUUKSED.

TÜDRUKUL ON JUUKSED.

PIKAD

LÜHIKESED

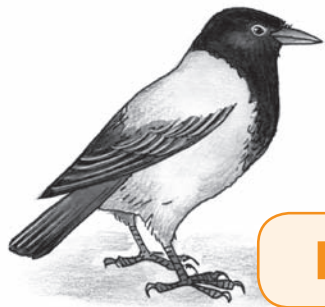

LÜHIKE

LÜHIKESED



PIKK

PIKAD

RÄÄGI.

KUREL ON NOKK.

VARESEL ON NOKK.

KUREL ON JALAD.

VARESEL ON JALAD.

LÜHIKE

PIKK

LÜHIKESED

PIKAD

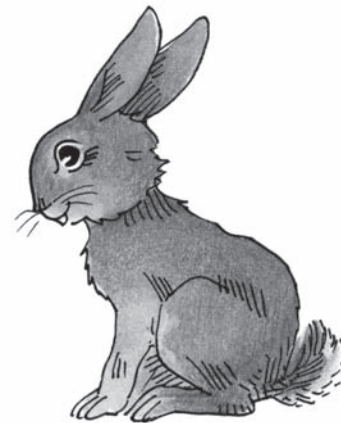
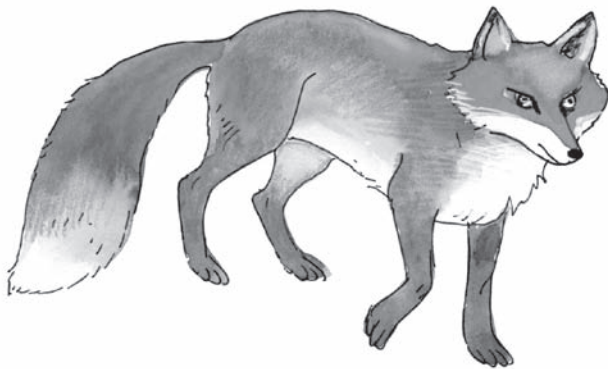

RÄÄGI.

JÄNESEL ON LÜHIKE

JÄNESEL ON PIKAD

REBASEL ON LÜHIKESED

REBASEL ON PIKK

SABA

KÕRVAD

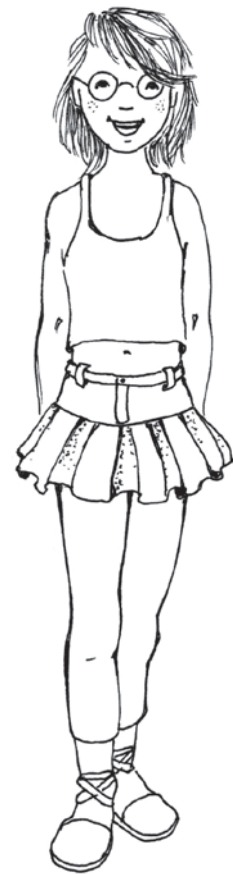

VÄRVI.

LÜHIKE SEELIK ON PUNANE.

PIKK SEELIK ON SININE.

RÄÄGI.

PIKAL TÜDRUKUL ON SEELIK.

LÜHIKESEL TÜDRUKUL ON SEELIK.

PIKK

LÜHIKE



VÄRVI.

PIKAD PÜKSID ON PRUUNID.

LÜHIKESED PÜKSID ON ROHELISED.

RÄÄGI.

LÜHIKESEL POISIL ON PÜKSID.

PIKAL POISIL ON PÜKSID.

PIKAD

LÜHIKESED

PIKEM – LÜHEM

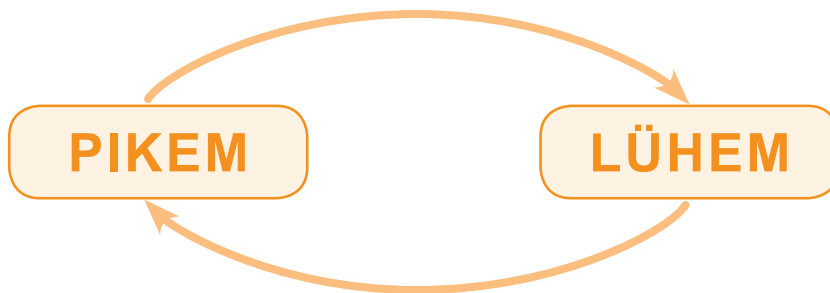
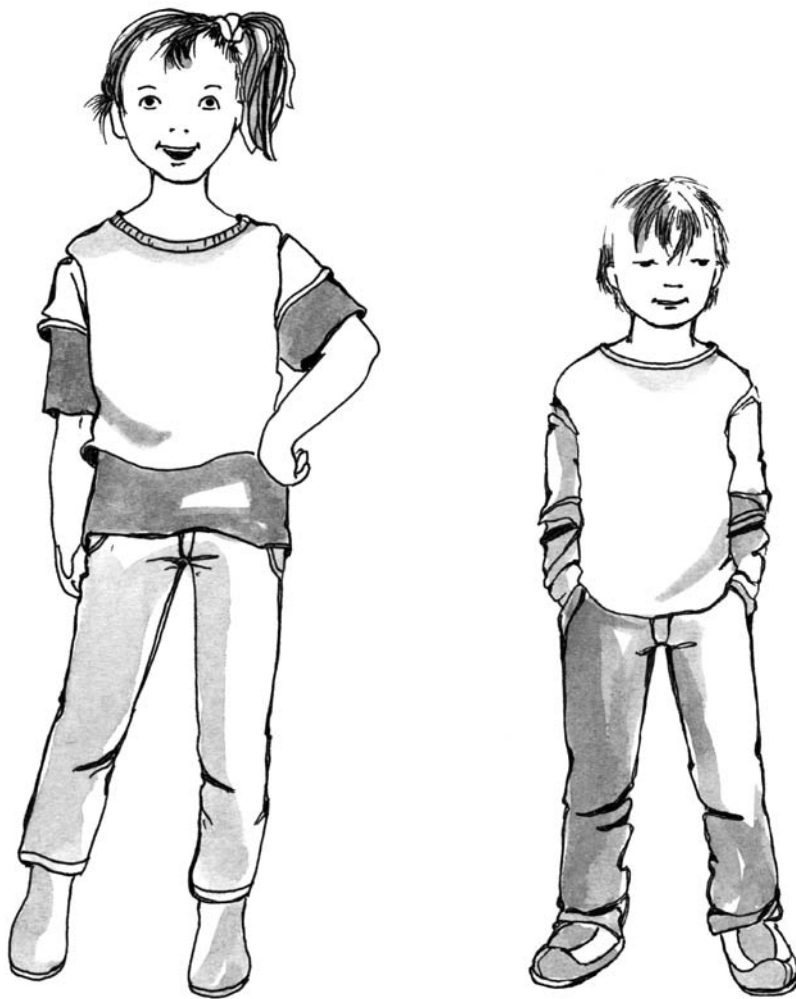

RÄÄGI.

KES ON PIKEM?

..... ON PIKEM.

KES ON LÜHEM?

..... ON LÜHEM.

TÜDRUK

POISS

VÖRDLE.

POISS ON KUI TÜDRUK.

TÜDRUK ON KUI POISS.

LÜHEM

PIKEM



RÄÄGI.

MIS ON PIKEM?

..... ON PIKEM.

MIS ON LÜHEM?

..... ON LÜHEM.

PLUUS

JOPE

VÖRDLE.

PLUUS ON KUI JOPE.

JOPE ON KUI PLUUS.

PIKEM

LÜHEM

RÄÄGI.

MIS ON LÜHEM?

..... ON LÜHEM.

MIS ON PIKEM?

..... ON PIKEM.

VEST

PLUUS

VÖRDLE.

VEST ON KUI PLUUS.

PLUUS ON KUI VEST.

PIKEM

LÜHEM



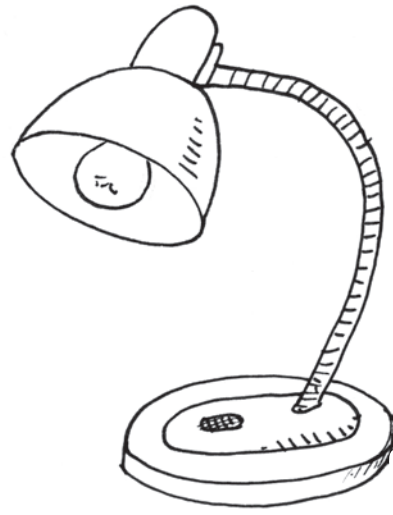
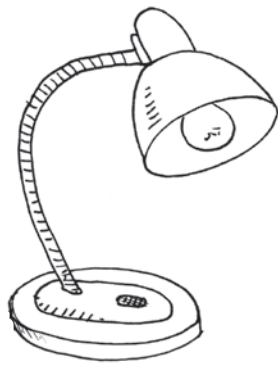

JOONISTA.

VÄIKSEMAL LAMBIL ON PIKEM JUHE.



VÄRVI.

KOLLASEL ROOSIL ON PIKEM VARS.

PUNASEL ROOSIL ON LÜHEM VARS.

JOONISTA PIKEM VARS.

VÄRVI.

PIKEM REHA VARS ON ROHELINE.

LÜHEM REHA VARS ON PRUUN.



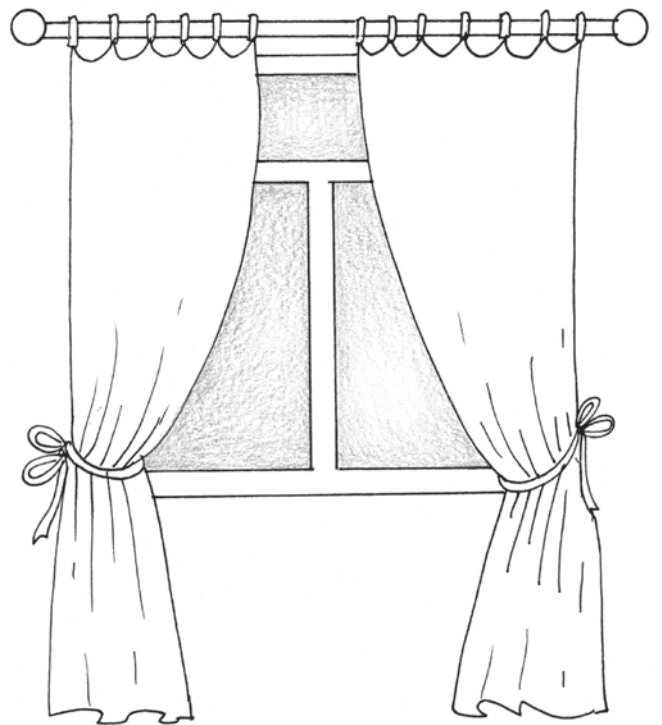
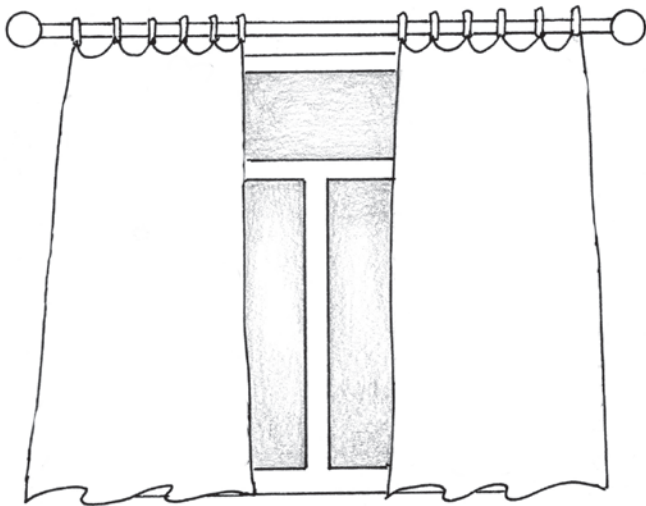

LEIA ERINEVUSED PILTIDEL.

VÄRVI.

PIKAD KARDINAD ON ROHELISED.

LÜHIKESED KARDINAD ON RUUDULISED.

VÖRDLE.

ROHELISED KARDINAD ON KUI

RUUDULISED KARDINAD.

PIKEMAD
LÜHEMAD

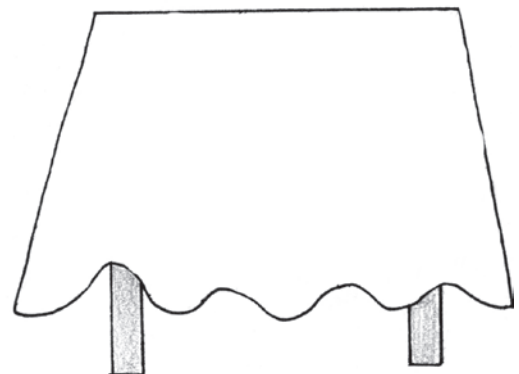
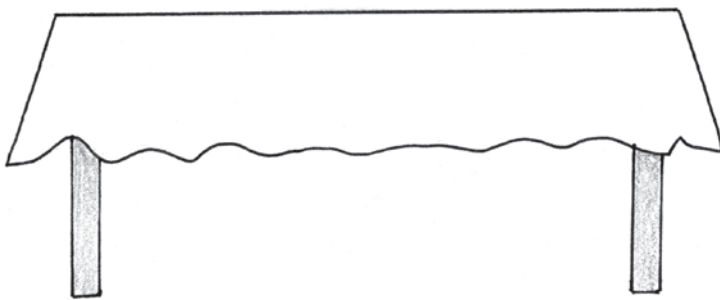

LEIA ERINEVUSED PILTIDEL.

VÄRVI.

LÜHIKE LAUD+LINA ON KOLLANE.

PIKK LAUD+LINA ON TRIIBULINE.

VÖRDLE.

TRIIBULINE LAUD+LINA ON KUI

KOLLANE LAUD+LINA.

PIKEM
LÜHEM

ÜHEPIKKUSED

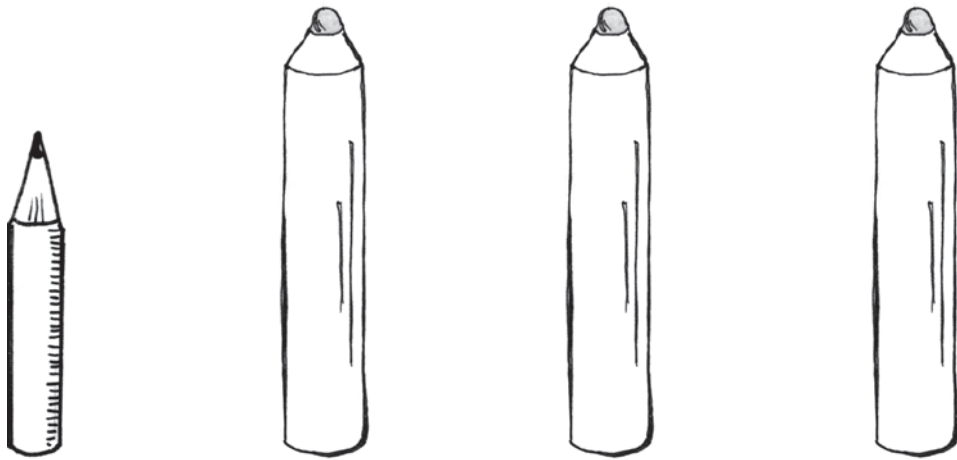

VÄRVI ÜHEPIKKUSED PLIATSID PUNASEKS.



VÄRVI ÜHEPIKKUSED KURGID ROHELISEKS.



VÄRVI ÜHEPIKKUSED PORGANDID KOLLASEKS.

LAI – KITSAS



VÄRVI.

LAI TREPP ON HALL.

KITSAS TREPP ON PRUUN.

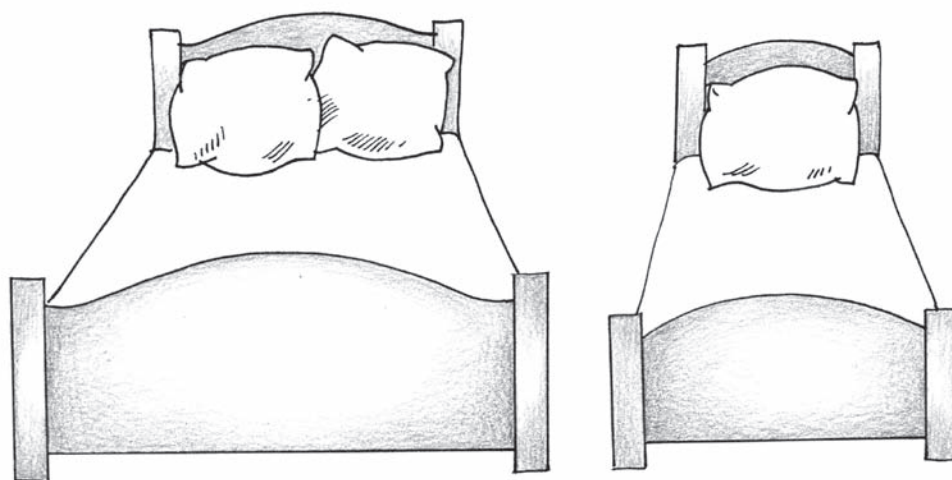

VÄRVI.

LAIAL VOODIL ON KOLLANE TEKK.

KITSAL VOODIL ON ROHELINE TEKK.



VÄRVI.

LAI SEELIK ON SININE.

KITSAS SEELIK ON PUNANE.

RÄÄGI.

SININE SEELIK ON

PUNANE SEELIK ON

KITSAS

LAI



VÄRVI.

LAIAD PÜKSID ON PRUUNID.

KITSAD PÜKSID ON MUSTAD.

RÄÄGI.

MUSTAD PÜKSID ON

PRUUNID PÜKSID ON

LAIAD

KITSAD

LAIEM – KITSAM

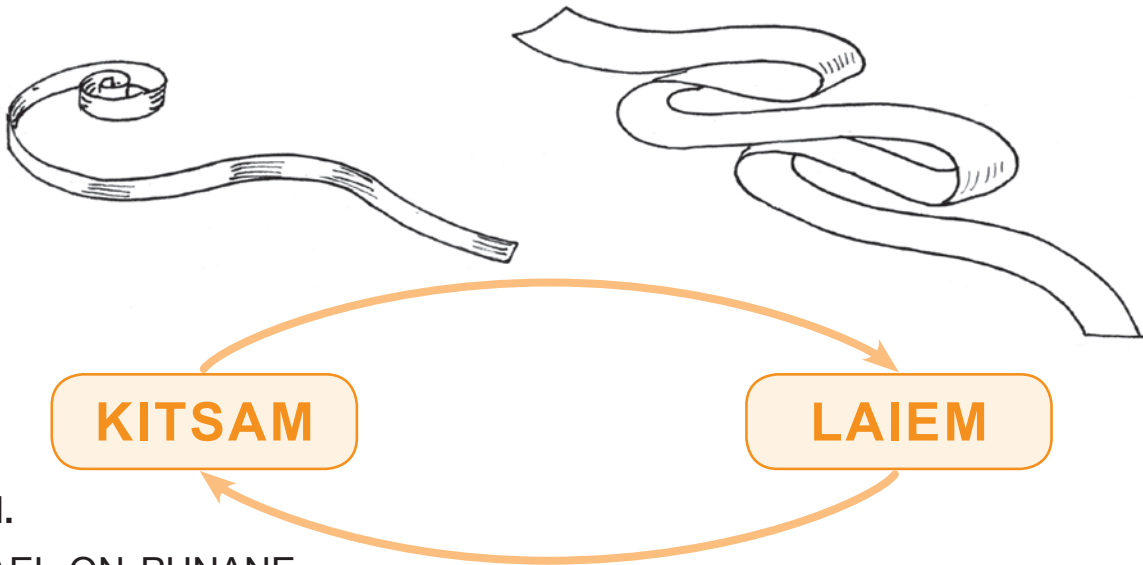

VÄRVI.

LAI PAEL ON PUNANE.

KITSAS PAEL ON SININE.

VÖRDLE.

PUNANE PAEL ON KUI SININE PAEL.

SININE PAEL ON KUI PUNANE PAEL.

LAIEM

KITSAM

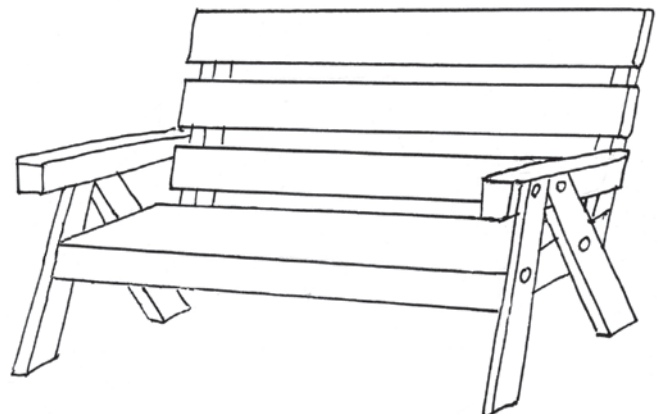
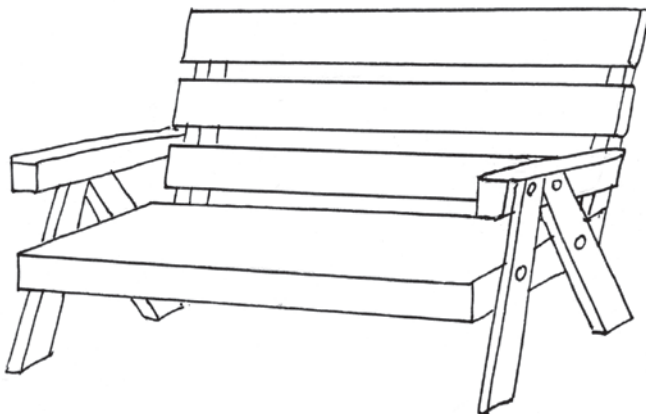

VÄRVI.

LAI PINK ON PRUUN.

KITSAS PINK ON KOLLANE.

VÖRDLE.

PRUUN PINK ON KUI KOLLANE PINK.

KOLLANE PINK ON KUI PRUUN PINK.

LAIEM

KITSAM



VÄRVI.

LAI SALL ON SININE.

KITSAS SALL ON PRUUN.

VÖRDLE.

SININE SALL ON KUI PRUUN SALL.

PRUUN SALL ON KUI SININE SALL.

KITSAM

LAIEM



VÄRVI.

LAI PEA+VÖRU ON PUNANE.

KITSAS PEA+VÖRU ON ROHELINE.

VÖRDLE.

PUNANE VÖRU ON KUI ROHELINE VÖRU.

ROHELINE VÖRU ON KUI PUNANE VÖRU.

LAIEM

KITSAM

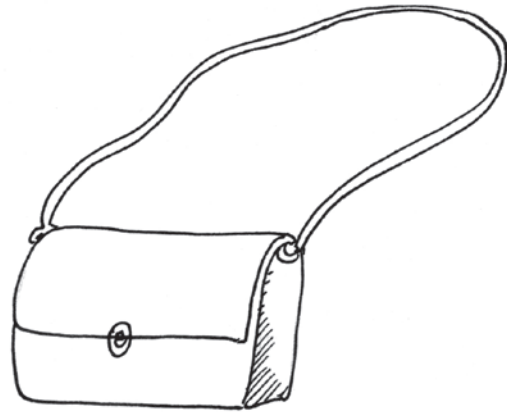
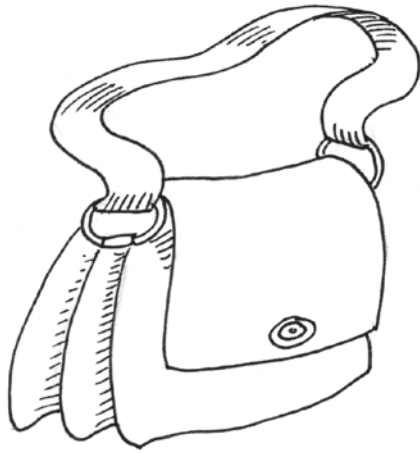

VÄRVI.

PUNASEL KOTIL ON KITSAS RIHM.

SINISEL KOTIL ON LAI RIHM.

VÖRDLE.

PUNASE KOTI RIHM ON KUI SINISE KOTI RIHM.

SINISE KOTI RIHM ON KUI PUNASE KOTI RIHM.

LAIEM

KITSAM

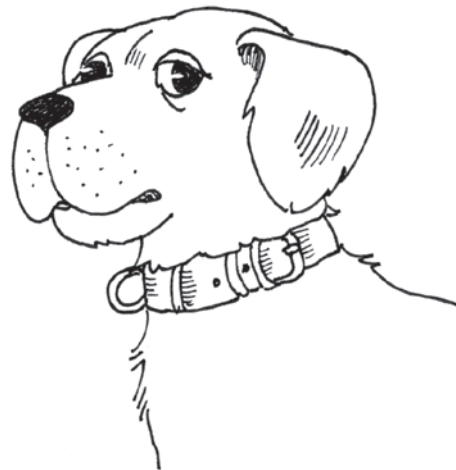

VÄRVI.

PRUUNIL KOERAL ON LAI KAELA+RIHM.

MUSTAL KOERAL ON KITSAS KAELA+RIHM.

LAI KAELA+RIHM ON PUNANE.

KITSAS KAELA+RIHM ON KOLLANE.

VÖRDLE.

PRUUNI KOERA RIHM ON KUI MUSTA KOERA RIHM.

MUSTA KOERA RIHM ON KUI PRUUNI KOERA RIHM.

LAIEM

KITSAM

ÜHELAIUSED

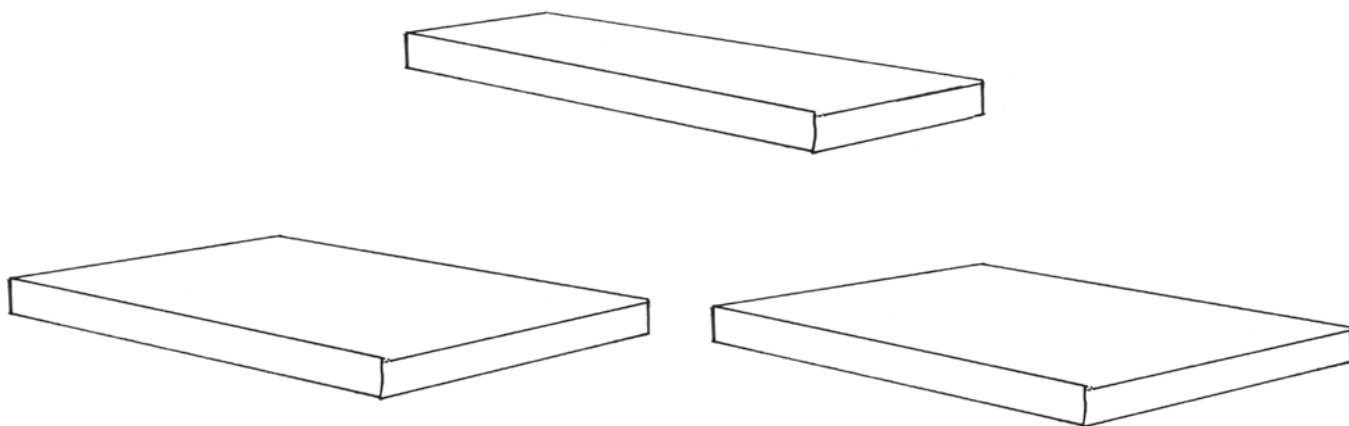

VÄRVI ÜHELAIUSED LAUAD.

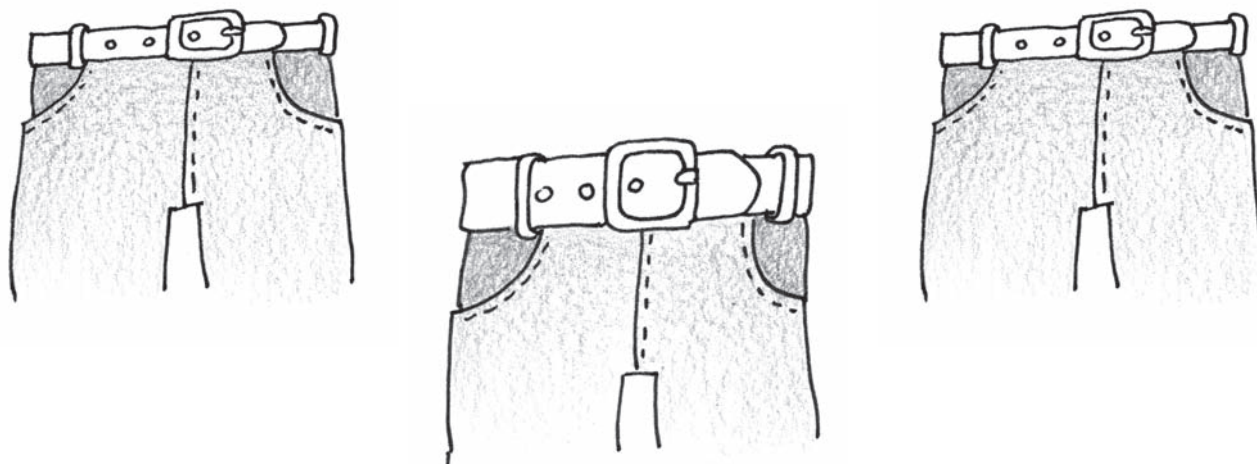

VÄRVI ÜHELAIUSED RIHMAD.



VÄRVI ÜHELAIUSED SÕRMUSED.

KÕRGE – MADAL



KÕRGE



MADAL

RÄÄGI.

KUUSK ON

ÕUNA+PUU ON

KÕRGE

MADAL

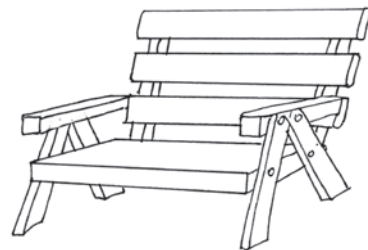
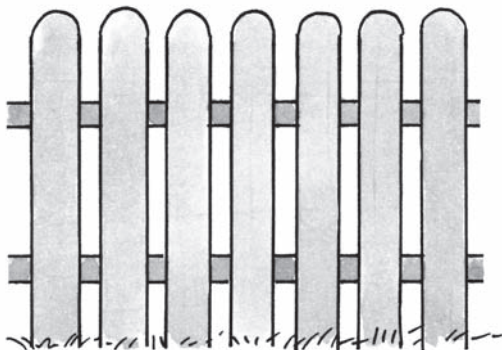

RÄÄGI.

AED ON

PINK ON

KÕRGE

MADAL

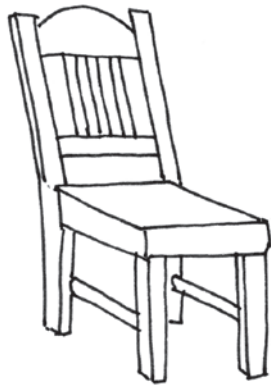

VÄRVI.

KÕRGE TOOL ON PRUUN.

MADAL TOOL ON ROHELINE.

RÄÄGI.

ROHELINE TOOL ON

PRUUN TOOL ON

KÕRGE

MADAL



VÄRVI.

KÕRGED LILLED ON KOLLASED.

MADALAD LILLED ON PUNASED.

RÄÄGI.

PUNASED LILLED ON

KOLLASED LILLED ON

KÕRGED

MADALAD

KÕRGEM – MADALAM

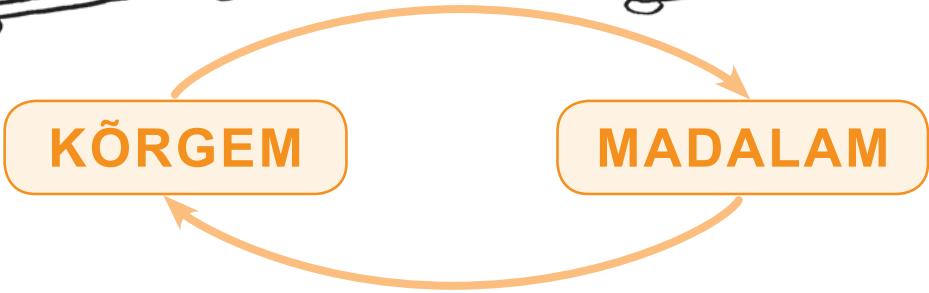

VÄRVI.

KÕRGE KAPP ON PRUUN.

MADAL KAPP ON KOLLANE.

VÖRDLE.

PRUUN KAPP ON KUI KOLLANE KAPP.

KOLLANE KAPP ON KUI PRUUN KAPP.

KÕRGEM

MADALAM

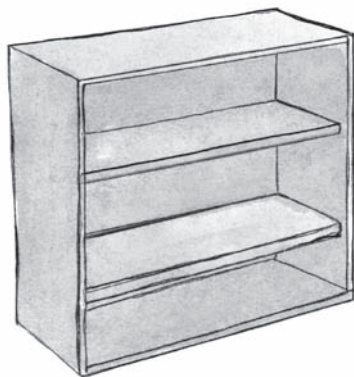

RÄÄGI.

RIIUL ON

TOOL ON

KÕRGE

MADAL

VÖRDLE.

RIIUL ON KUI TOOL.

TOOL ON KUI RIIUL.

KÕRGEM

MADALAM

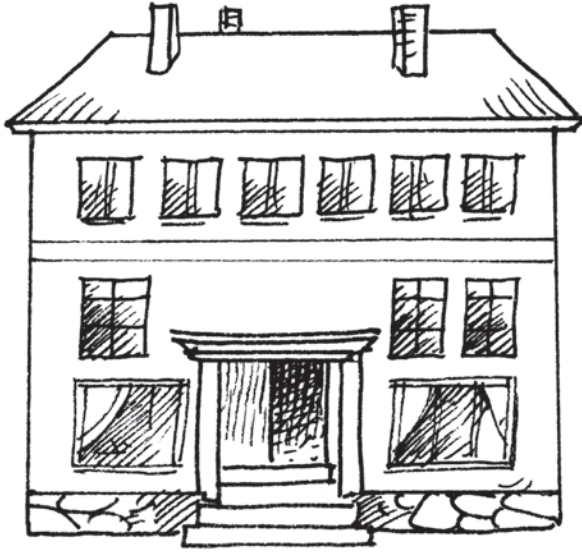

VÖRDLE.

PUU ON KUI MAJA.

MAJA ON KUI PUU.

VÄRVI SEE, MIS ON MADALAM.

KÖRGEM

MADALAM

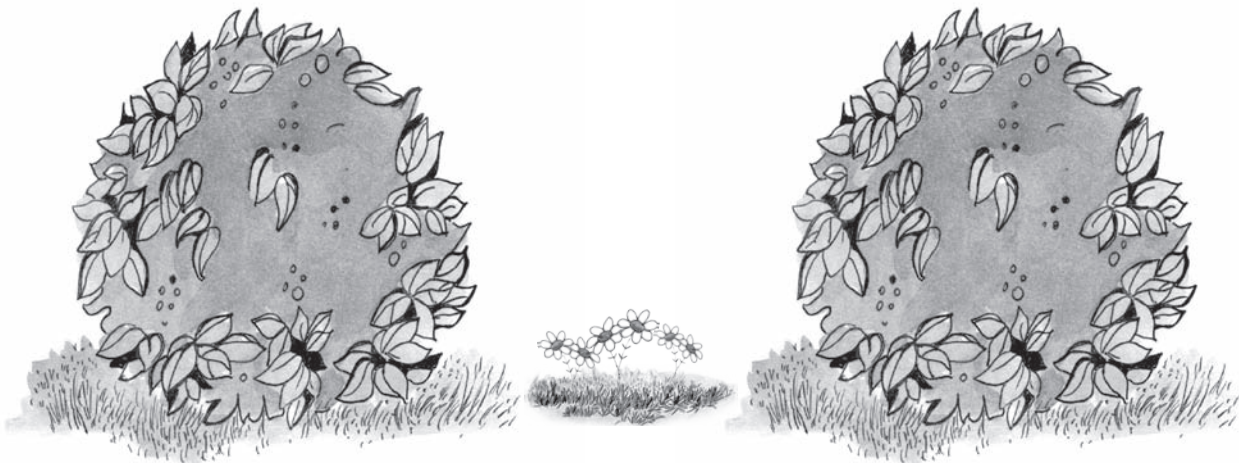

RÄÄGI.

LILLED ON

PÕÕSAD ON

KÖRGED

MADALAD

VÖRDLE.

PÕÕSAD ON KUI LILLED.

LILLED ON KUI PÕÕSAD.

KÖRGEMAD

MADALAMAD

ÜHEKÕRGUSED



VÄRVI ÜHEKÕRGUSED MAJAD.



VÄRVI ÜHEKÕRGUSED PUUD.



VÄRVI ÜHEKÕRGUSED VAASID.

KÕRGEMAL – MADALAMAL

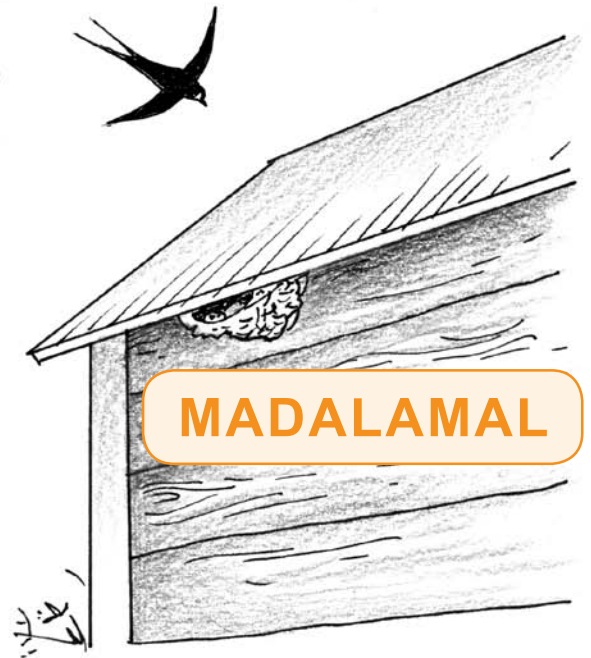
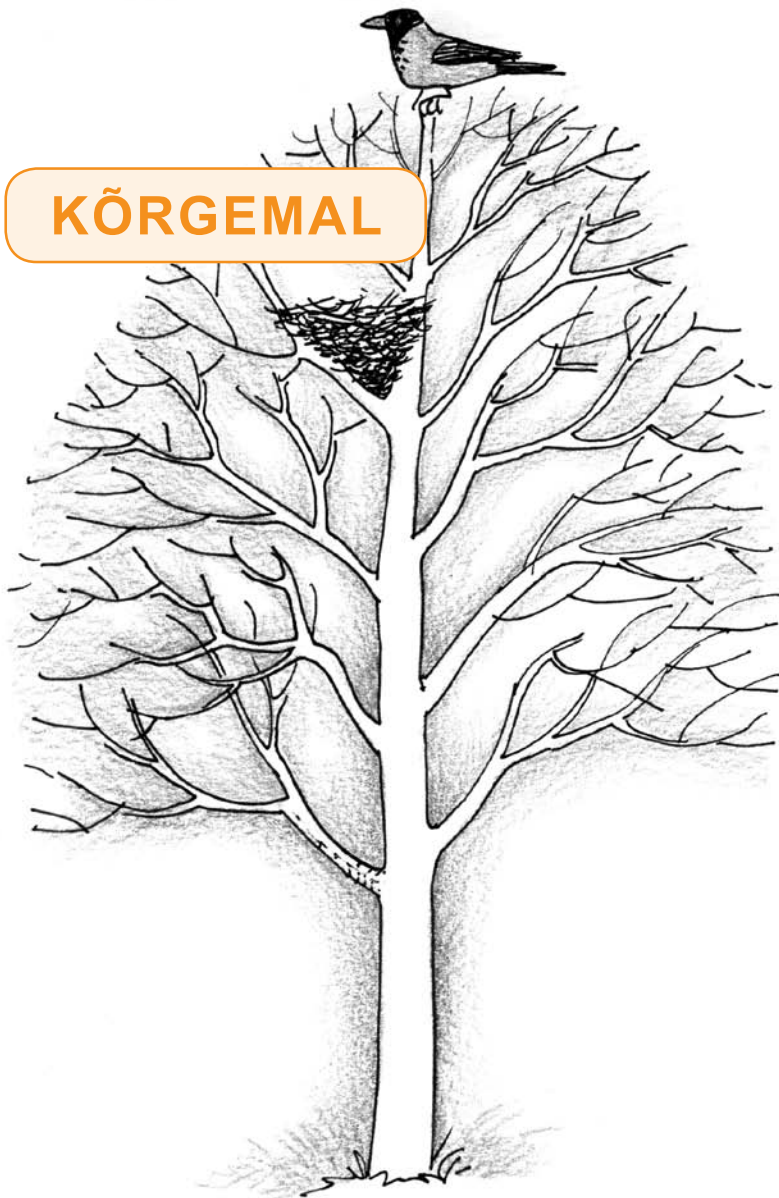

RÄÄGI.

PÄÄSUKESE PESA ON

VARESE PESA ON

KÕRGEL

MADALAL

VÖRDLE.

PÄÄSUKESE PESA ON KUI VARESE PESA.

VARESE PESA ON KUI PÄÄSUKESE PESA.

KÕRGEMAL

MADALAMAL

VÄRVI PESA, MIS ON KÕRGEMAL.

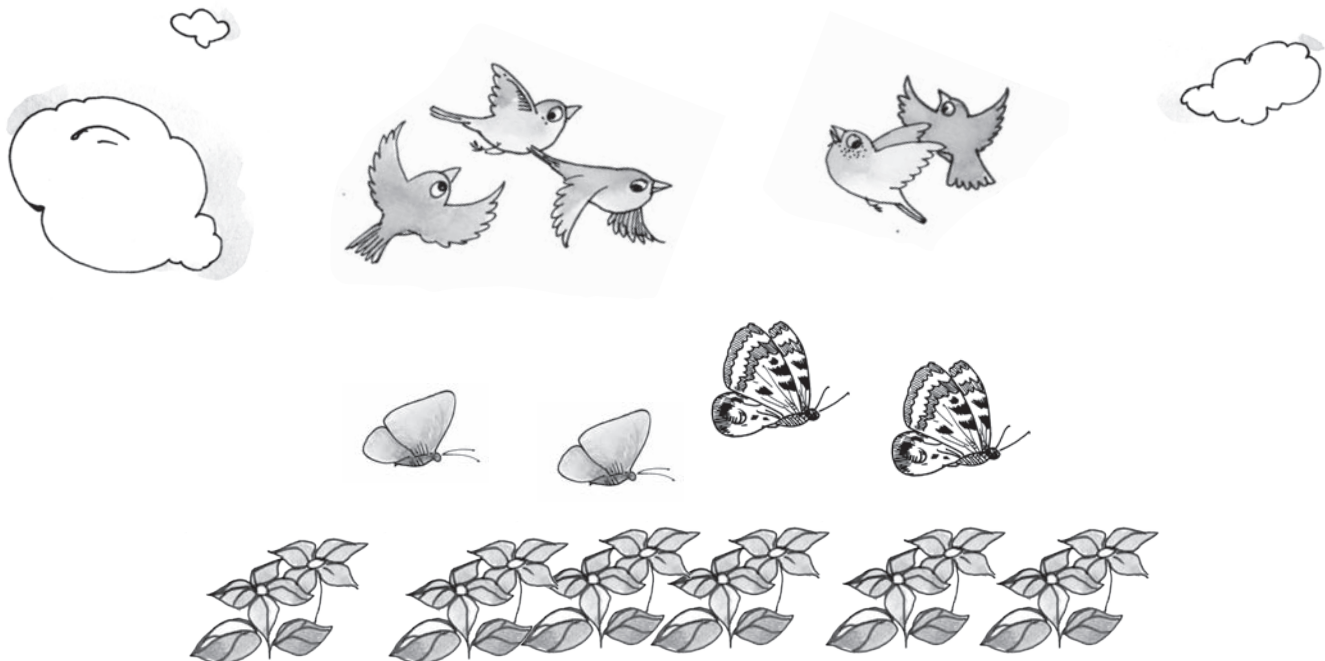

RÄÄGI.

LIBLIKAD LENDAVID

LINNUD LENDAVID

KÕRGEL

MADALAL

VÖRDLE.

LINNUD LENDAVID KUI LIBLIKAD.

LIBLIKAD LENDAVID KUI LINNUD.

KÕRGEMAL

MADALAMAL



RÄÄGI.

KELL RIPUB

PILT RIPUB

KÕRGEL

MADALAL

VÖRDLE.

PILT RIPUB KUI KELL.

KELL RIPUB KUI PILT.

KÕRGEMAL

MADALAMAL

PAKS – ÕHUKE

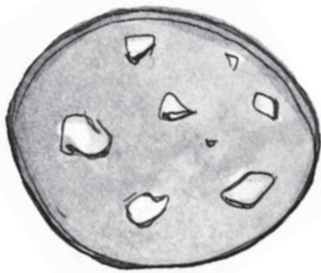

ÕHUKE

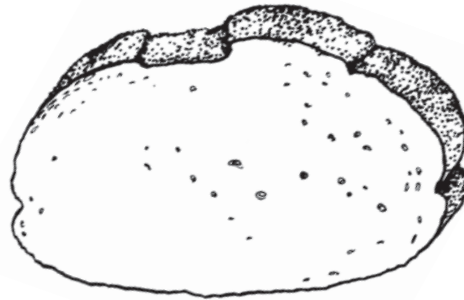

PAKS

RÄÄGI.

VORSTI+VIIL ON

LEIVA+VIIL ON

PAKS

ÕHUKE



VÄRVI.

PAKS ALBUM ON SININE.

ÕHUKE ALBUM ON KOLLANE.



VÄRVI.

PAKS SALL ON HALL.

ÕHUKE SALL ON LILLELINE.



PAKSEM – ÕHEM

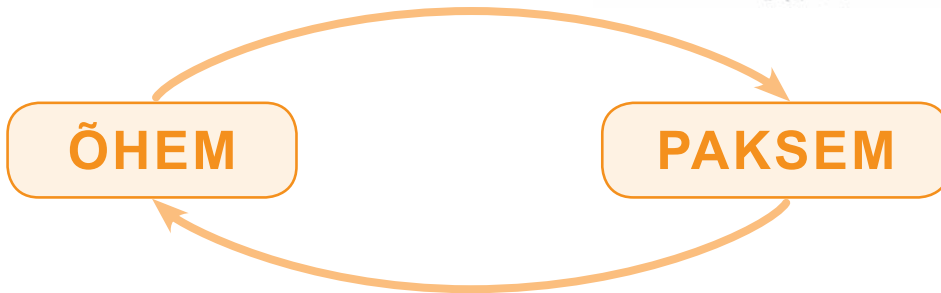

VÄRVI.

ÕHUKE KAMPSUN ON PUNANE.

PAKS KAMPSUN ON SININE.

VÖRDLE.

PUNANE KAMPSUN ON KUI SININE KAMPSUN.

SININE KAMPSUN ON KUI PUNANE KAMPSUN.

PAKSEM

ÕHEM

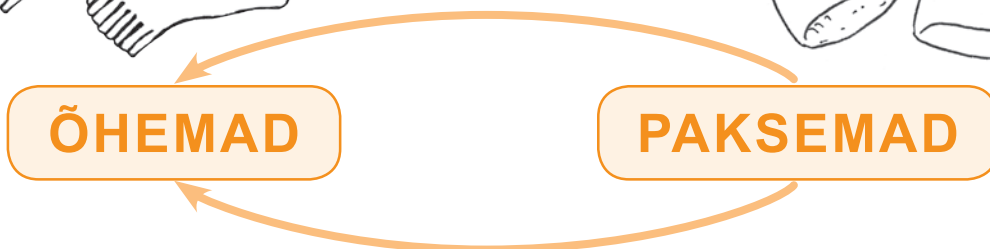

VÄRVI.

PAKSUD KINDAD ON PRUUNID.

ÕHUKESED KINDAD ON HALLID.

VÖRDLE.

PRUUNID KINDAD ON KUI HALLID KINDAD.

HALLID KINDAD ON KUI PRUUNID KINDAD.

PAKSEMAD

ÕHEMAD

JÄME – PEENIKE



JÄME



PEENIKE

VÄRVI.

PEENIKE KETT ON KOLLANE.

JÄME KETT ON HALL.

RÄÄGI.

KOLLANE KETT ON

HALL KETT ON

JÄME

PEENIKE



RÄÄGI.

KASE TÜVI ON

TAMME TÜVI ON

JÄME

PEENIKE

VÄRVI.

JÄMEDAD KRUVID ON MUSTAD.

PEENIKESED KRUVID ON HALLID.

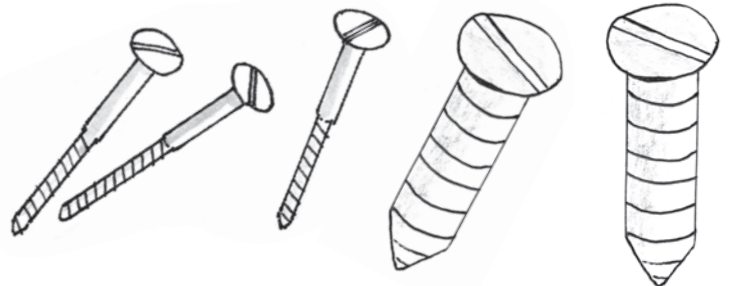

RÄÄGI.

HALLID KRUVID ON

MUSTAD KRUVID ON

JÄMEDAD

PEENIKESED

JÄMEDAM – PEENEM

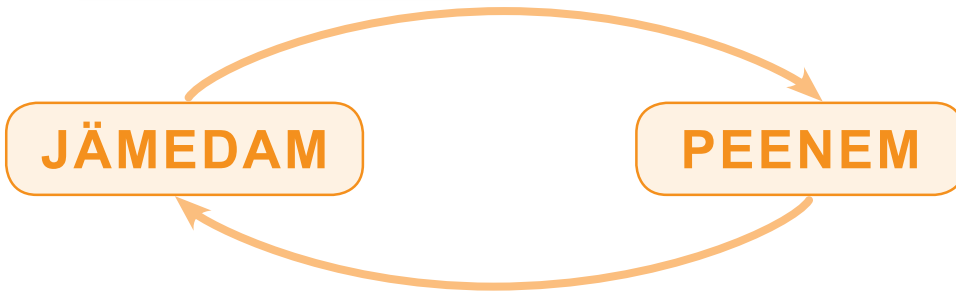
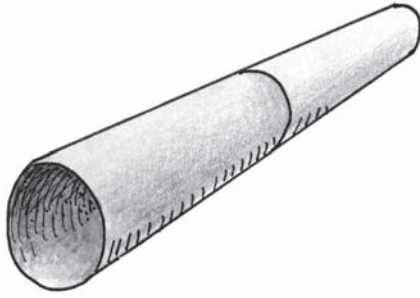

VÄRVI.

PEENIKE TORU ON PRUUN.

JÄME TORU ON HALL.

VÖRDLE.

PRUUN TORU ON KUI HALL TORU.

HALL TORU ON KUI PRUUN TORU.

JÄMEDAM

PEENEM

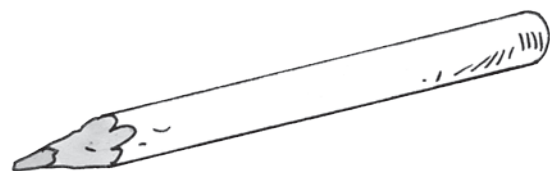
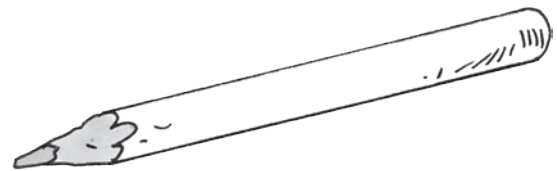
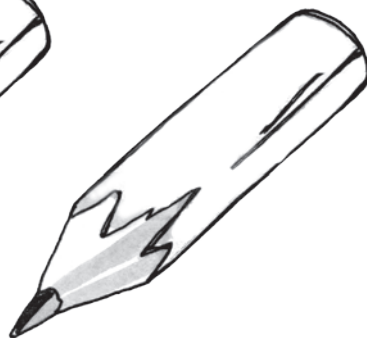
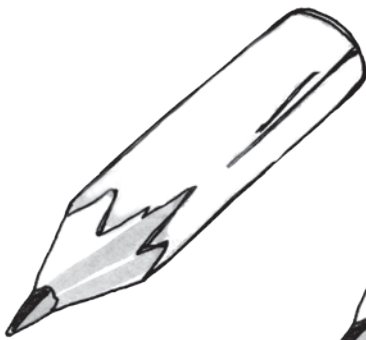

VÄRVI.

JÄMEDAD PLIIATSID ON SINISED.

PEENIKESED PLIIATSID ON PUNASED.

VÖRDLE.

PUNASED PLIIATSID ON KUI SINISED PLIIATSID.

SINISED PLIIATSID ON KUI PUNASED PLIIATSID.

JÄMEDAMAD

PEENEMAD

SÜGAV – MADAL

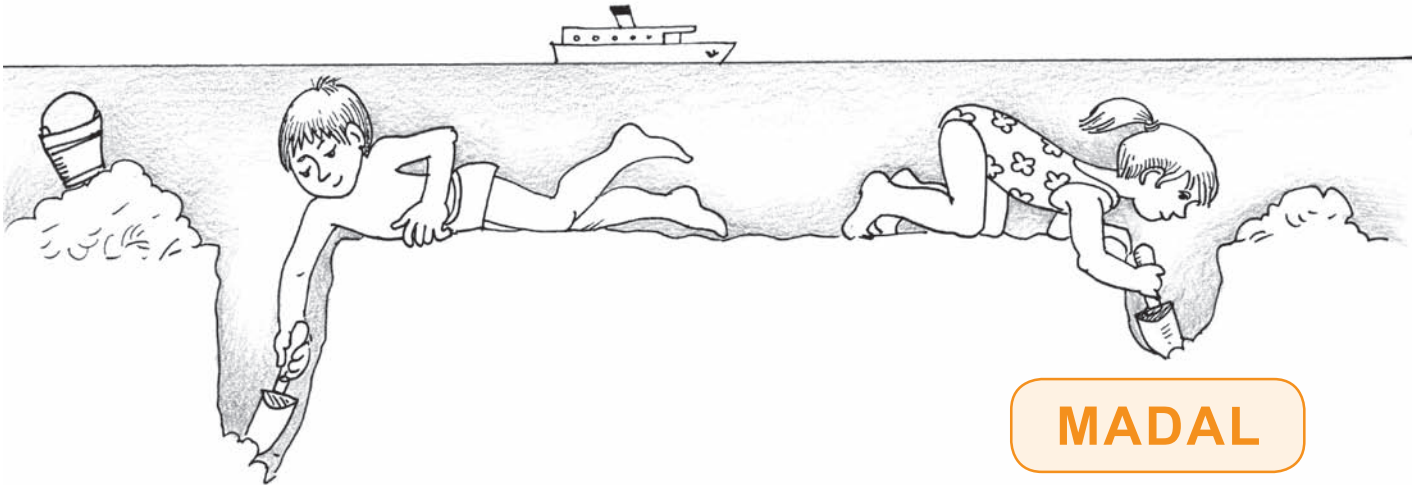

SÜGAV

MADAL

RÄÄGI.

TÜDRUK KAEVAS AUGU.

POISS KAEVAS AUGU.

SÜGAVA

MADALA

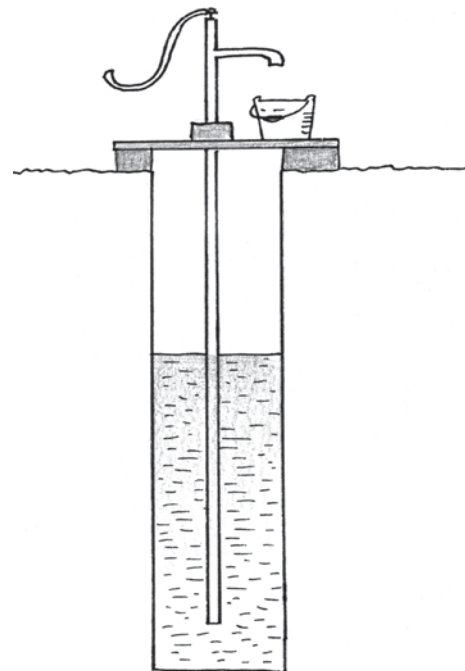
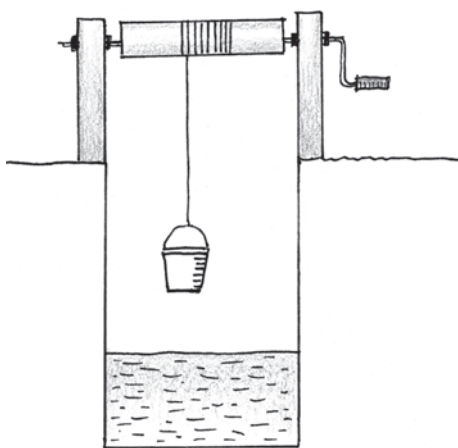

JOONISTA.

SÜGAVAS KAEVUS ON KIVID.

RÄÄGI.

ÄMBER ON KAEVUS.

MADALAS

SÜGAVAS

SÜGAVAMAL – MADALAMAL

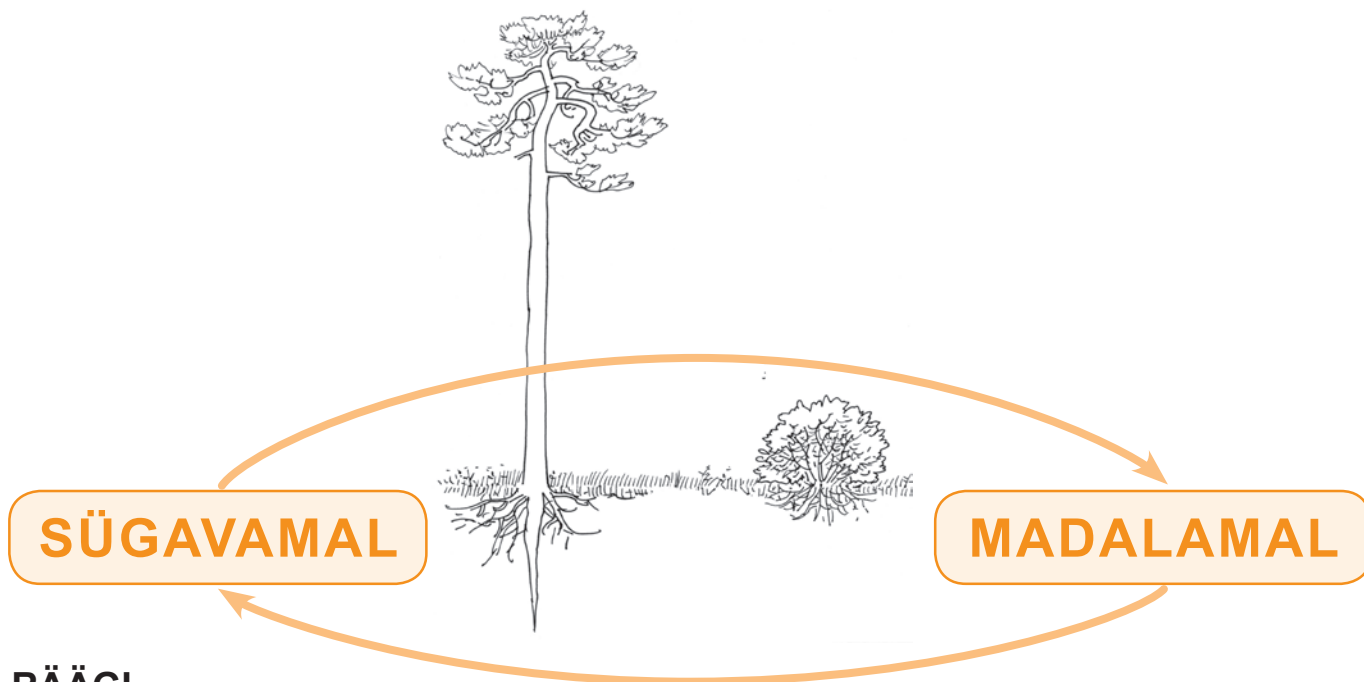

RÄÄGI.

PUU JUURED ON

PÕÕSA JUURED ON

SÜGAVAL

MADALAL

VÖRDLE.

PUU JUURED ON KUI PÕÕSA JUURED.

PÕÕSA JUURED ON KUI PUU JUURED.

SÜGAVAMAL

MADALAMAL

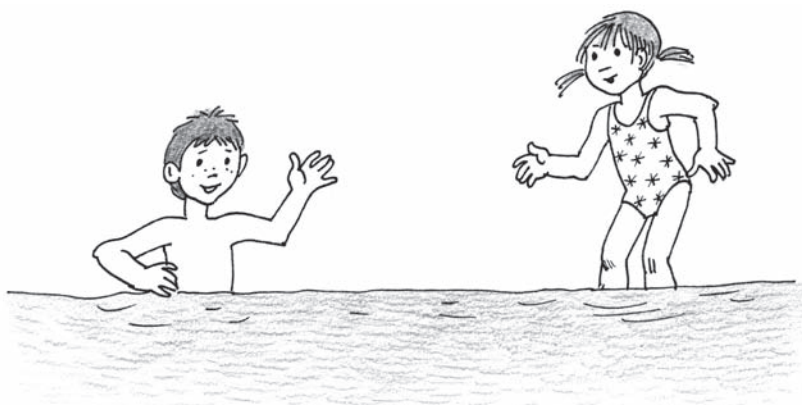

RÄÄGI.

TÜDRUK ON VEES.

POISS ON VEES.

SÜGAVAS

MADALAS

VÖRDLE.

POISS ON VEES KUI TÜDRUK.

TÜDRUK ON VEES KUI POISS.

SÜGAVAMAS

MADALAMAS

ÜLEVAL – ALL ÜLES – ALLA

ÜLEVAL

ALLA

ÜLES

ALL

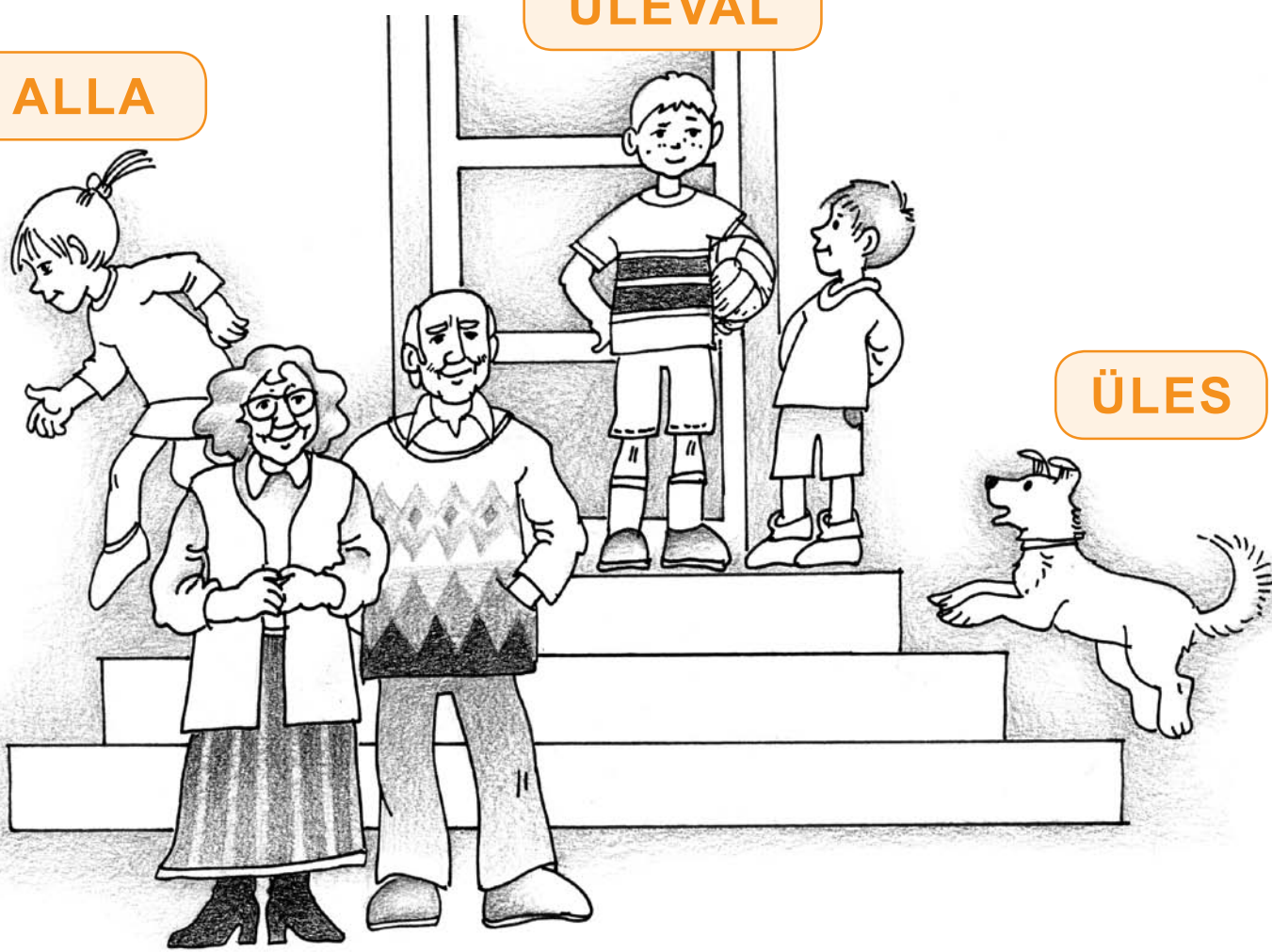

RÄÄGI.

KOER LÄHEB

POISID ON

TÜDRUK LÄHEB

VANA+EMA JA VANA+ISA ON

ÜLEVAL

ALL

ÜLES

ALLA

RÄÄGI.

POISS ON

POISS VAATAB

TÜDRUK ON

TÜDRUK VAATAB

ÜLEVAL

ALL

ÜLES

ALLA

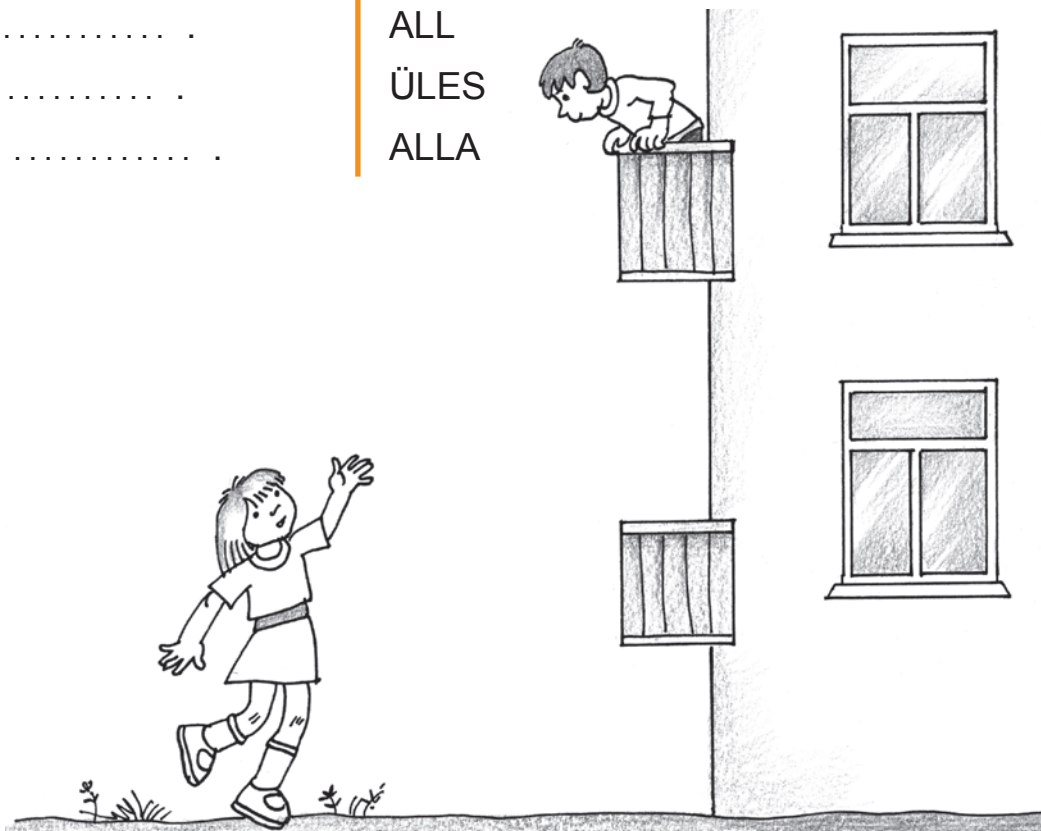

RÄÄGI.

KASS ON

KASS VAATAB

LIND ON

LIND VAATAB

ÜLEVAL

ALL

ÜLES

ALLA

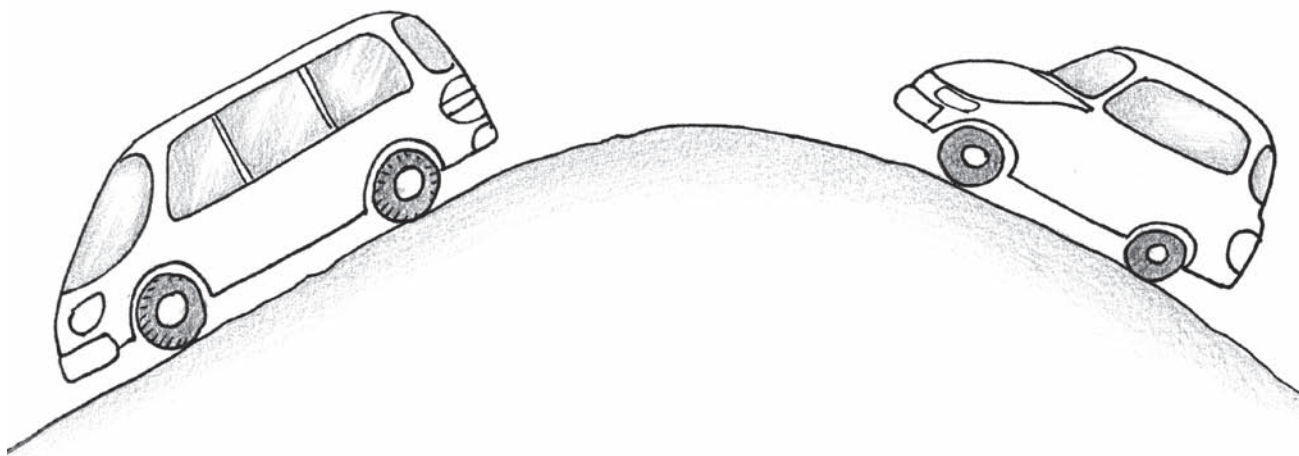

VÄRVI.

AUTO, MIS SÕIDAB MÄEST ÜLES ON SININE.

AUTO, MIS SÕIDAB MÄEST ALLA ON PUNANE.

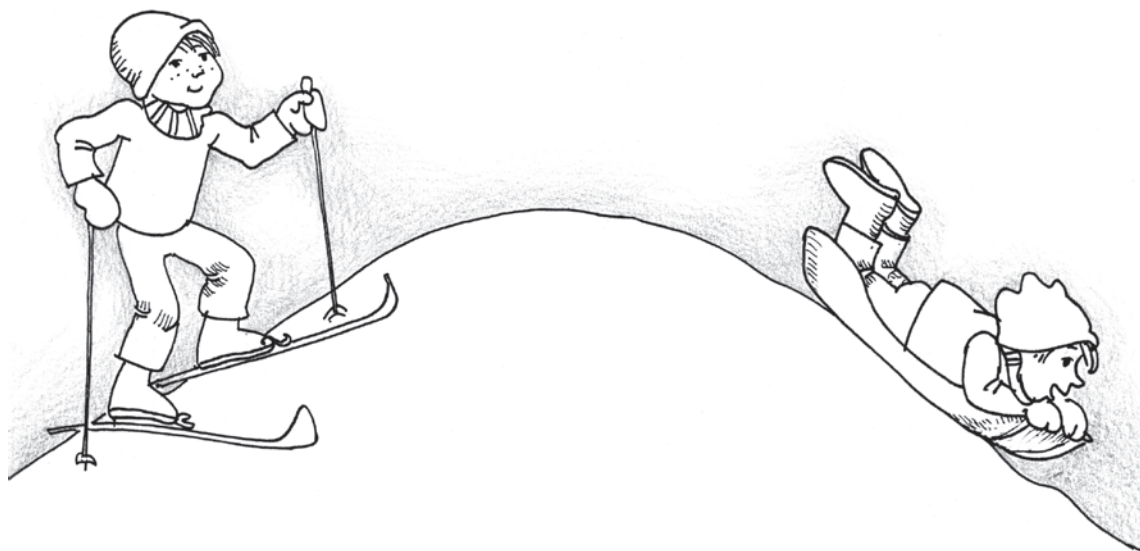

VÄRVI.

LAPSEL, KES SÕIDAB MÄEST ALLA ON ROHELINE MÜTS.

LAPSEL, KES SÕIDAB MÄEST ÜLES ON KOLLANE MÜTS.



MÄRGI NOOLEGA, KUHU LAPS SÕIDAB.

RÄÄGI, MIS JUHTUS MATIGA.



MATI RONIB

MATI KUKUB

ALLA

ÜLES

RÄÄGI, MIS JUHTUS KITIGA.

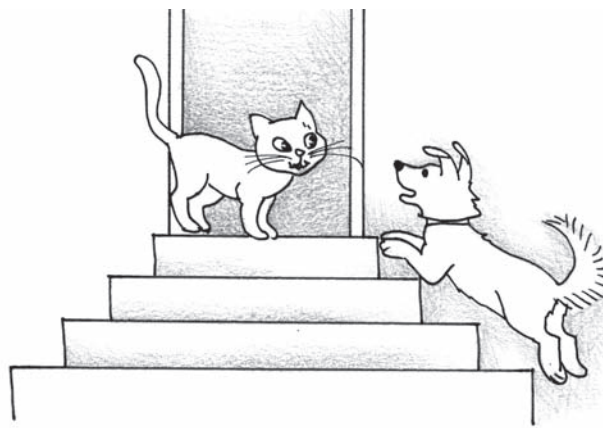
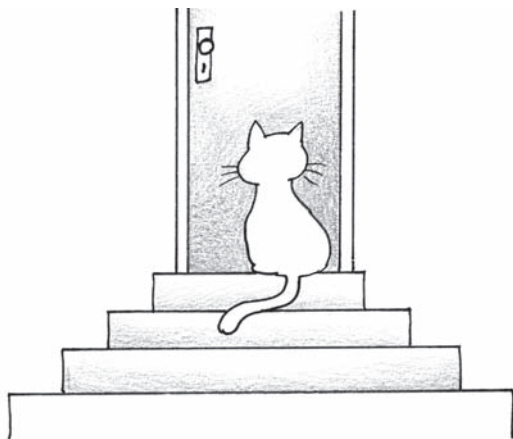

KOER JOOKSEB

KASS HÜPPAB

ALLA

ÜLES

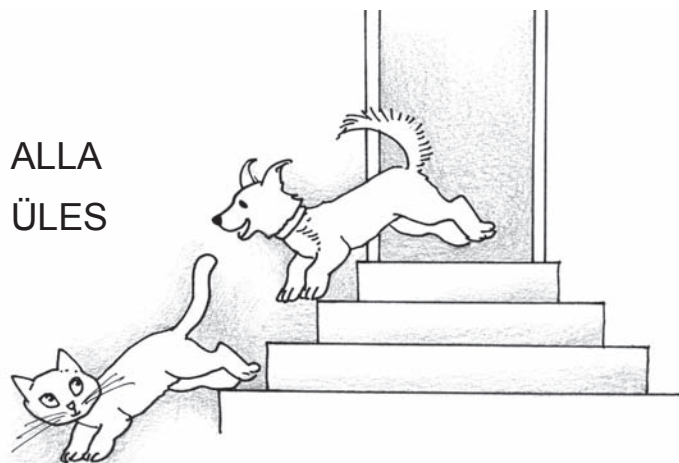

ÜLEMINE – ALUMINE

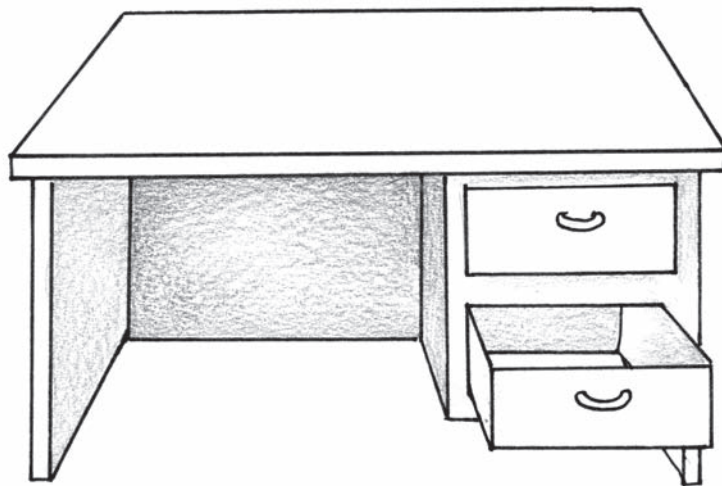

ÜLEMINE

ALUMINE

RÄÄGI.

..... SAHTEL ON LAHTI.

..... SAHTEL ON KINNI.

ÜLEMINE

ALUMINE

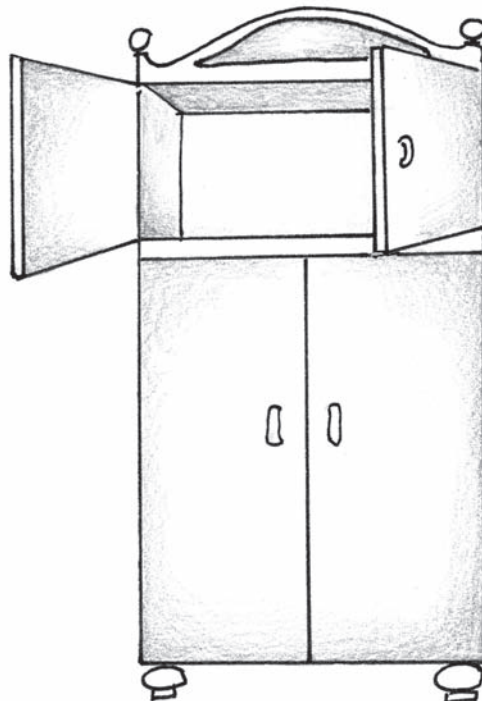

RÄÄGI.

..... KAPI UKSED ON KINNI.

..... KAPI UKSED ON LAHTI.

ÜLEMISE

ALUMISE

MÕTLE, MIS VÕIKS OLLA ÜLEMISES KAPIS. JOONISTA.



VÄRVI.

ÜLEMISEL RIIULIL ON MAASIKA+MOOS.

ALUMISEL RIIULIL ON MUSTIKA+MOOS.



RÄÄGI.

ANU ELAB KORRUSEL.

RAUL ELAB KORRUSEL.

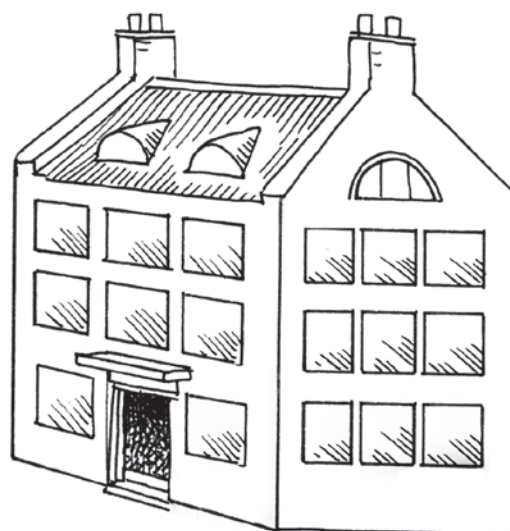

ÜLEMISEL

ALUMISEL

VÄRVI.

RAULI KODU AKNAD ON KOLLASED.

ANU KODU AKNAD ON HALLID.

EES – TAGA

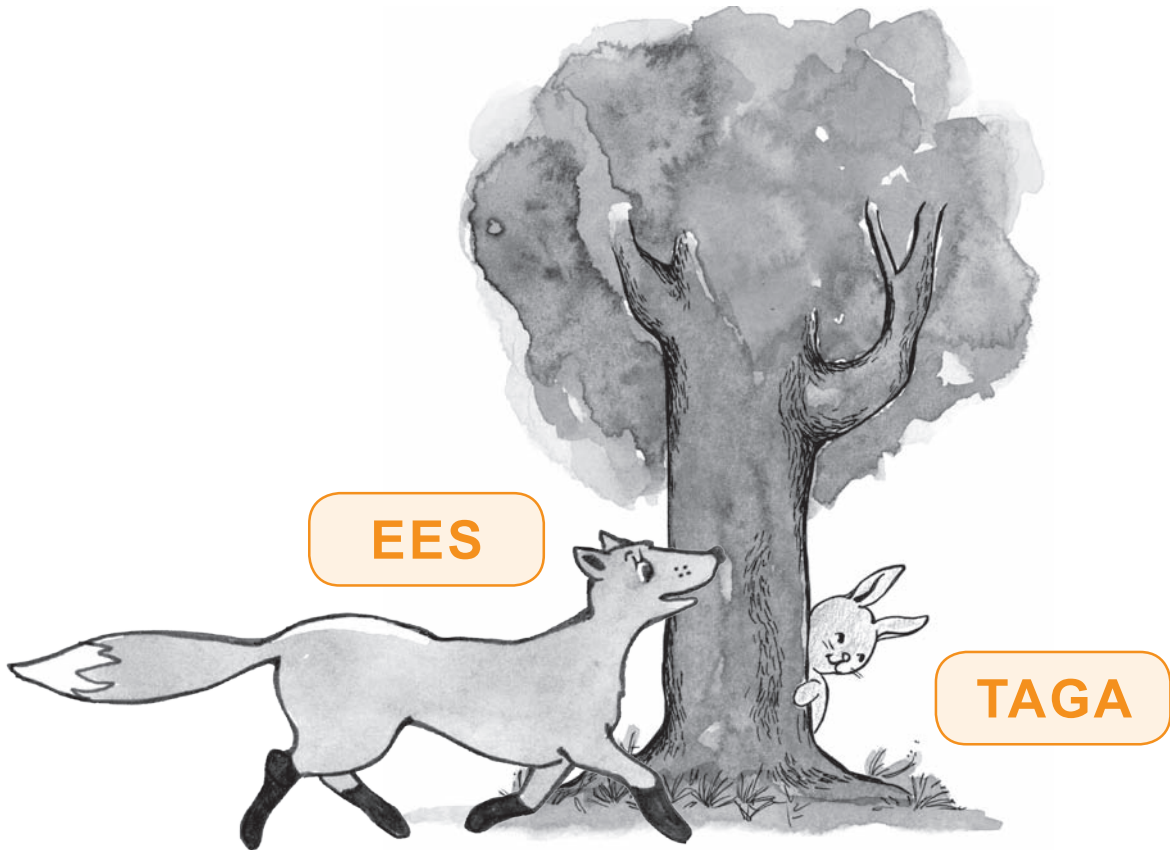

RÄÄGI.

JÄNES ON PUU

REBANE ON PUU

EES

TAGA



RÄÄGI.

MAJA EES ON

MAJA TAGA ON

PUU

AUTO



TAGA



EES

RÄÄGI.

POEG KÄIB ISA

ISA KÄIB POJA

EES

TAGA

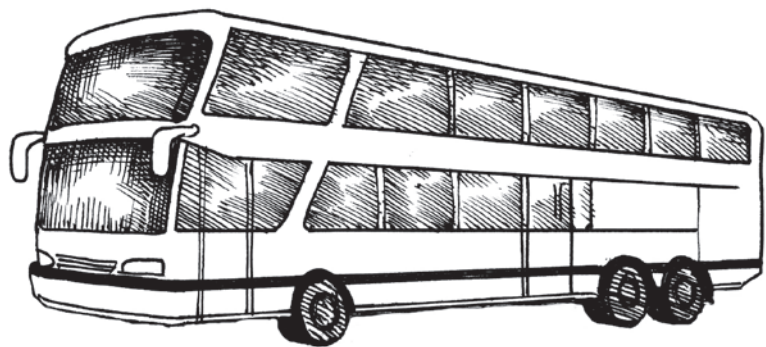
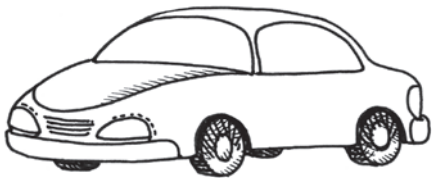

RÄÄGI.

AUTO SÕIDAB BUSSI

BUSS SÕIDAB AUTO

EES

TAGA

VÄRVI SEE, MIS SÕIDAB TAGA.

EES – TAGA ETTE – TAHA



JOOKSEB



TAHA



ON

TAGA

RÄÄGI.

POISS JOOKSEB TÜNNI

POISS ON TÜNNI

TAHA

TAGA

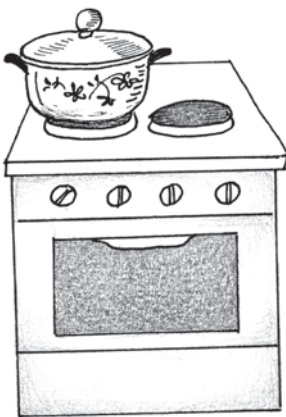

LÄHEB

ETTE



ON

EES

RÄÄGI.

EMA LÄHEB PLIIDI

EMA ON PLIIDI

ETTE

EES



ON

EES

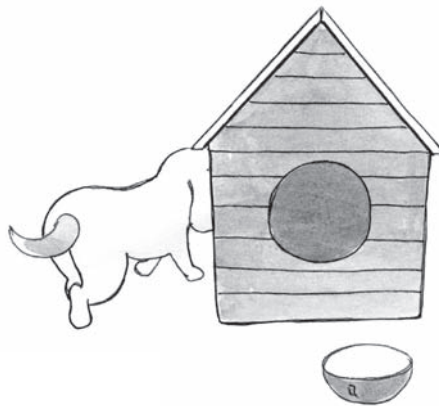

LÄHEB

TAHA



ON

TAGA

RÄÄGI.

KOER ISTUB KUUDI

KOER LÄHEB KUUDI

KOER LAMAB KUUDI

EES

TAGA

ETTE

TAHA

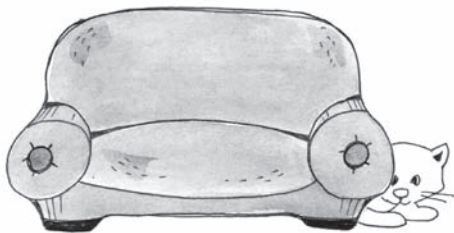

ON

TAGA

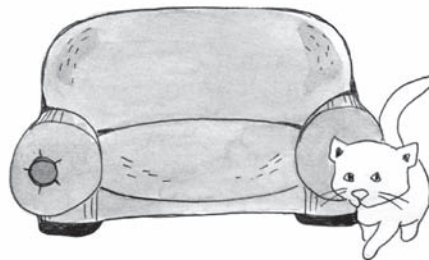

TULEB

ETTE

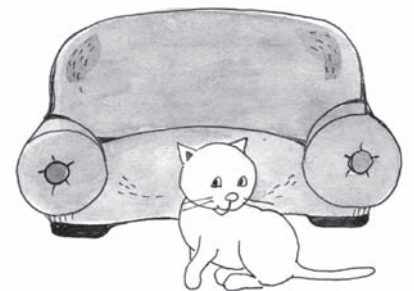

ON

EES

RÄÄGI.

KASS LAMAB TOOLI

KASS TULEB TOOLI

KASS ISTUB TOOLI

EES

TAGA

ETTE

TAHA

LÄHEDAL – KAUGEL



KAUGEL



LÄHEDAL

RÄÄGI.

LEA ON

TIIT ON

KAUGEL

LÄHEDAL



RÄÄGI.

VARSS ON

HOBUNE ON

LÄHEDAL

KAUGEL



RÄÄGI.

AUTO+BUSS ON

BUSSI+PEATUS ON

LÄHEDAL

KAUGEL

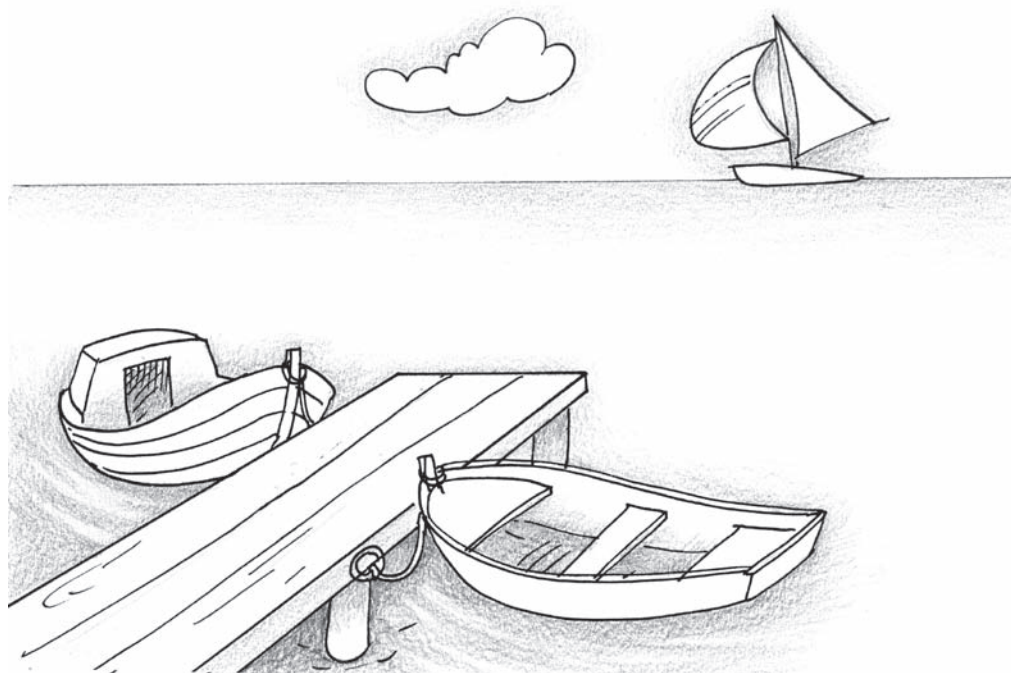

RÄÄGI.

PAADID ON

PURJEKAS ON

LÄHEDAL

KAUGEL

LÄHEMAL – KAUGEMAL

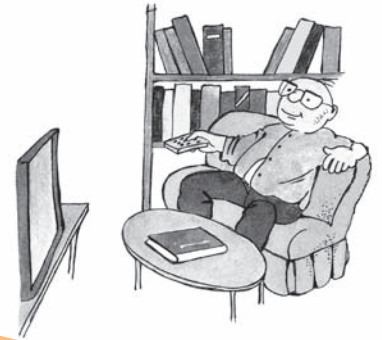

LÄHEMAL

KAUGEMAL

RÄÄGI.

VANA+EMA ISTUB

LÄHEDAL

VANA+ISA ISTUB

KAUGEL

VÖRDLE.

VANA+ISA ISTUB KUI VANA+EMA.

LÄHEMAL

VANA+EMA ISTUB KUI VANA+ISA.

KAUGEMAL



RÄÄGI.

MAJA ON

LÄHEDAL

TRAKTOR ON

KAUGEL

VÖRDLE.

MAJA ON KUI TRAKTOR.

LÄHEMAL

TRAKTOR ON KUI MAJA.

KAUGEMAL

VASAK – PAREM

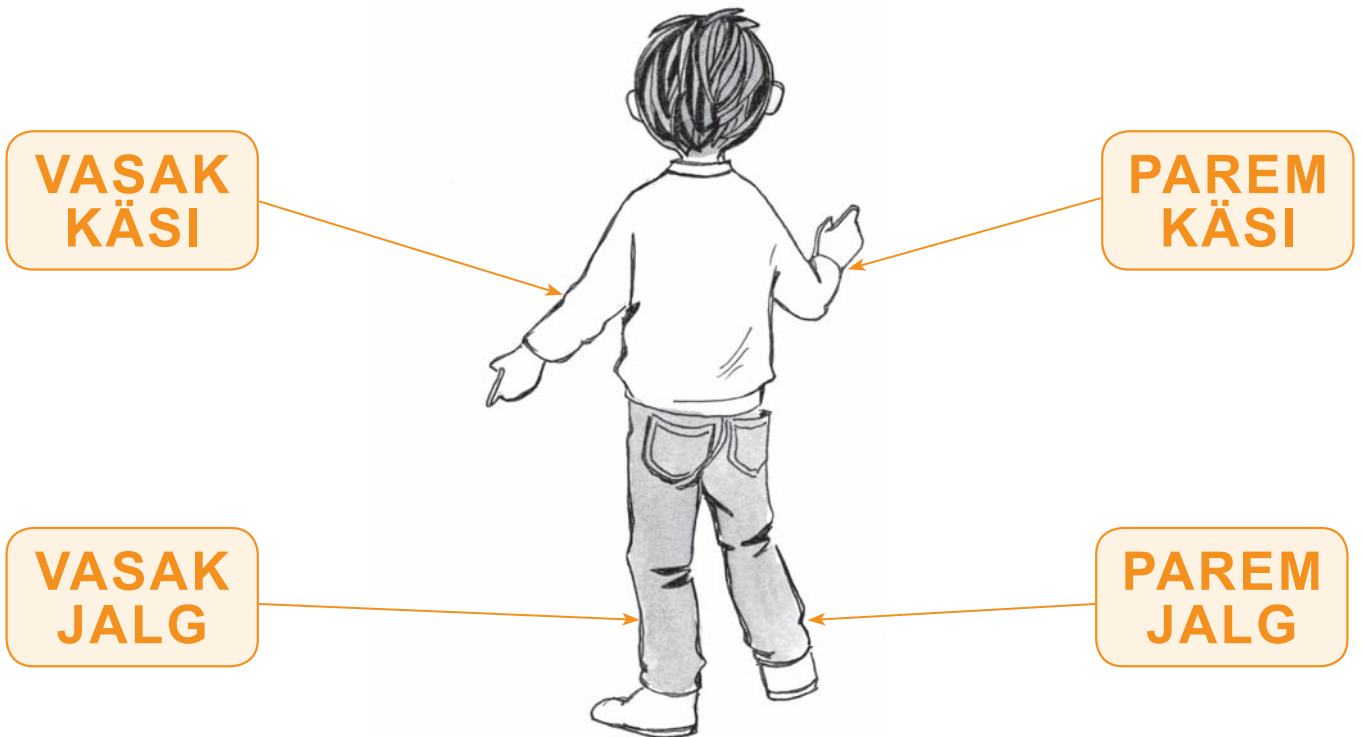

TÕSTA OMA PAREM JALG (VASAK JALG).

JOONISTA.

POISIL ON VASAKUS KÄES RAAMAT JA PAREMAS KÄES PLIATS.



RÄÄGI.

KOTT ON KÄES.

KEPP ON KÄES.

PAREMAS

VASAKUS



RÄÄGI.

PAREMAS KÄES ON

VASAKUS KÄES ON

ÕHU+PALL.

LILL.



RÄÄGI.

SAABAS ON JALAS.

SUSS ON JALAS.

PAREMAS

VASAKUS

PAREMAL (POOL) – VASAKUL (POOL)

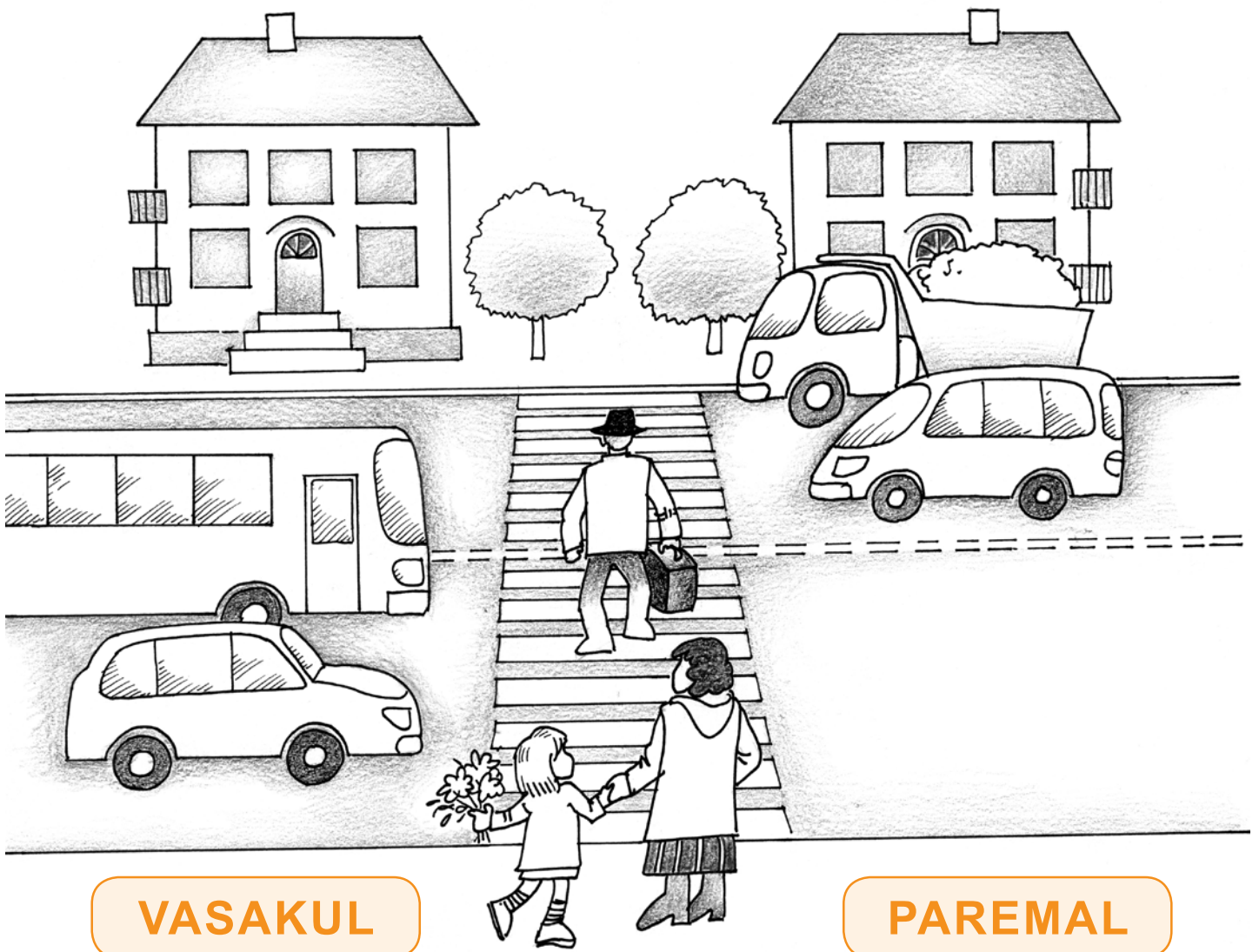

VASAKUL

PAREMAL

RÄÄGI.

SÕIDU+AUTO SEISAB

VEO+AUTO SEISAB

PAKI+AUTO SEISAB

AUTO+BUSS SEISAB

VASAKUL
PAREMAL

ONUL ON KOHVER KÄES.

LEAL ON LILLED KÄES.

PAREMAS
VASAKUS

EMA VAATAB

LEA VAATAB

PAREMALE
VASAKULE



VÄRVI.

PUNANE JALG+RATAS ON VASAKUL.

SININE JALG+RATAS ON PAREMAL.

RÄÄGI.

VASAKUL ON JALG+RATAS.

PAREMAL ON JALG+RATAS.

SUUR

VÄIKE

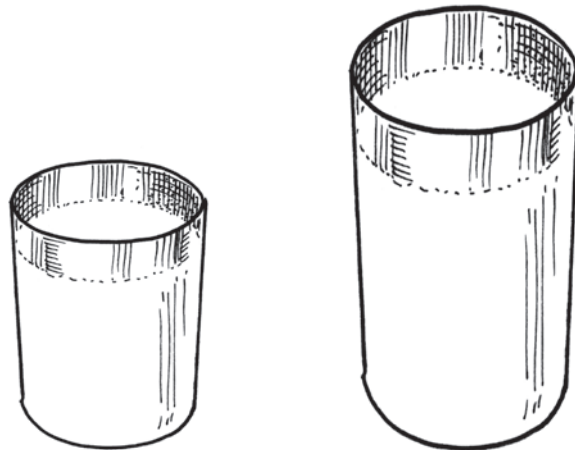

VÄRVI.

PAREMAL KLAASIS ON ÕUNA+MAHL.

VASAKUL KLAASIS ON TOMATI+MAHL.

RÄÄGI.

KÕRGE KLAAS ON

MADAL KLAAS ON

PAREMAL

VASAKUL

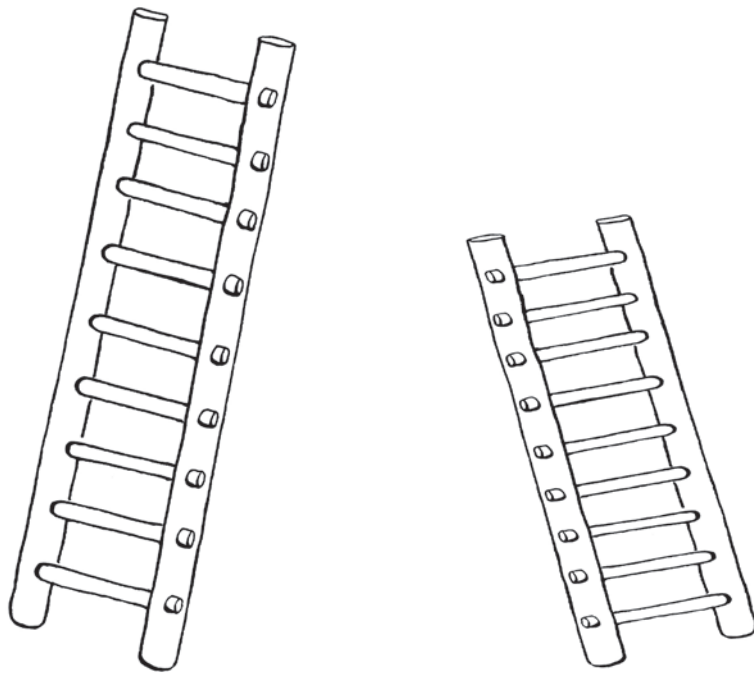

VÄRVI.

KOLLANE REDEL ON VASAKUL.

PRUUN REDEL ON PAREMAL.

RÄÄGI.

LÜHIKE REDEL ON

PIKK REDEL ON

PAREMAL

VASAKUL

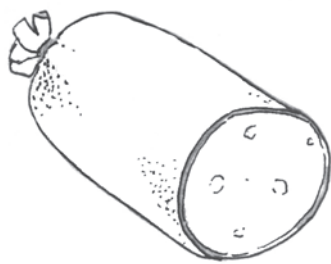

VÄRVI.

SUITSU+VORST ON PAREMAL.

KEEDU+VORST ON VASAKUL.

RÄÄGI.

VASAKUL ON VORST.

PAREMAL ON VORST.

JÄME

PEENIKE

SIIN – SEAL

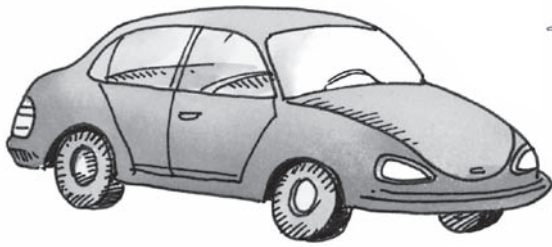

SIIN

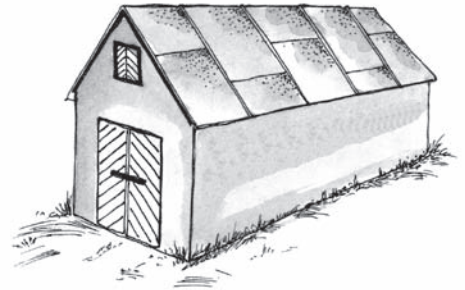

SEAL

RÄÄGI.

SIIN ON

SEAL ON

AUTO

GARAAŽ

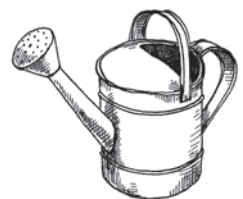
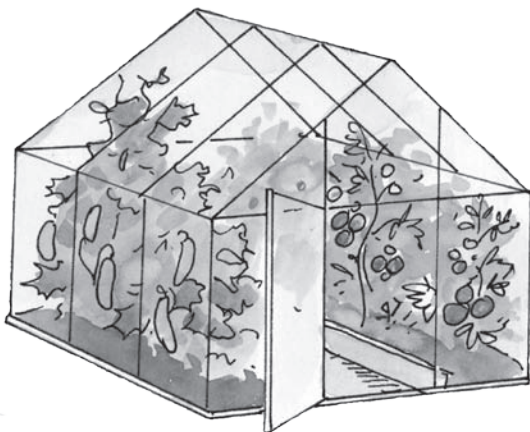

RÄÄGI.

SEAL ON

SIIN ON

KASTE+KANN

KASVU+MAJA



RÄÄGI.

PRILLID ON

AJA+LEHT ON

SIIN

SEAL



RÄÄGI.

RÄTIK ON

SEEP ON

SIIN

SEAL

KESKEL – VAHEL



KESKEL

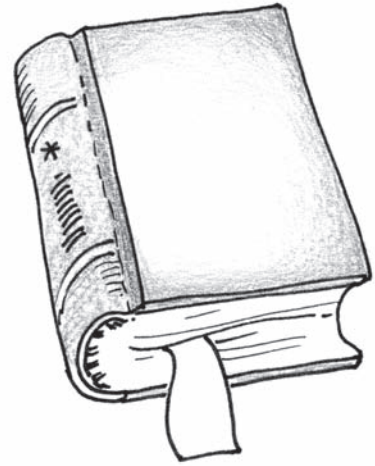

VAHEL

RÄÄGI.

TÜDRUK ON RINGI

JÄRJE+HOIDJA ON RAAMATU

KESKEL

VAHEL



RÄÄGI.

POISS VAATAB UKSE

ROOS ON TORDI

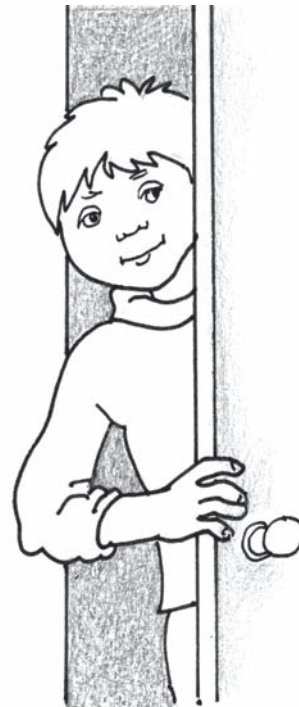

VAHEL

KESKEL

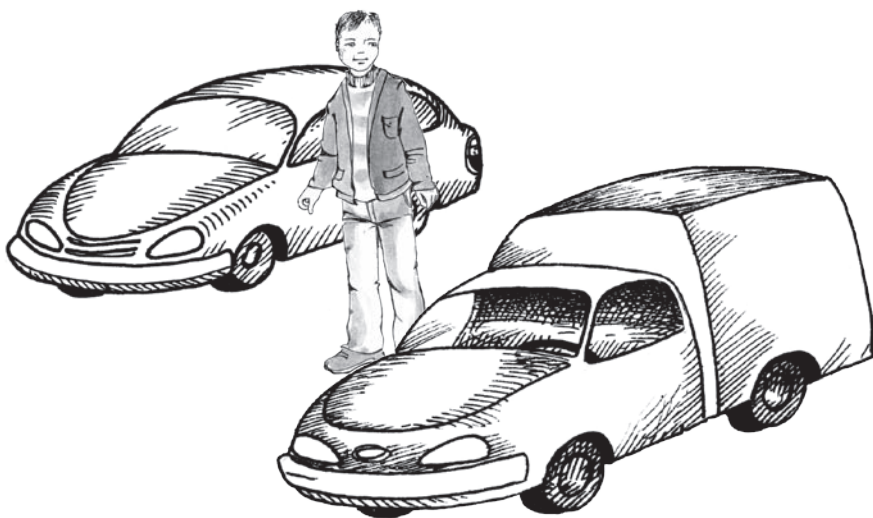

RÄÄGI.

ISA SEISAB AUTODE

VAAS ON LAUA

KESKEL

VAHEL

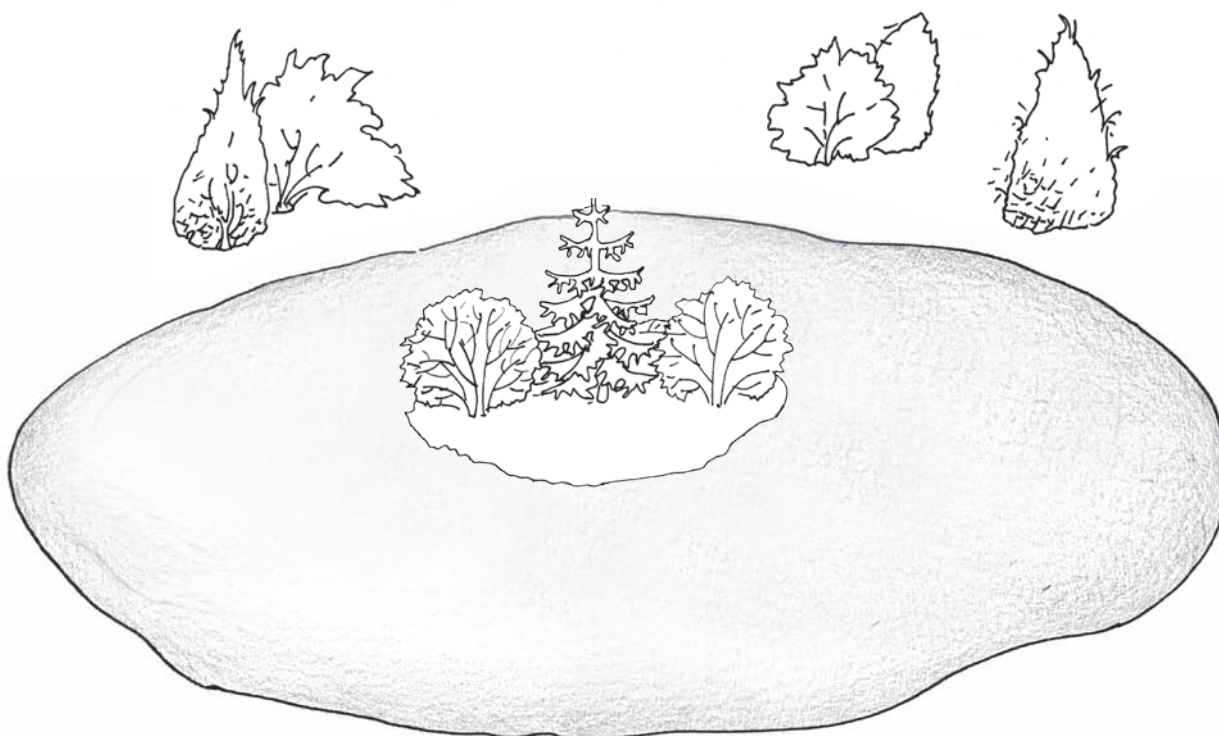

RÄÄGI.

SAAR ON TIIGI

KUUSK KASVAB SAARE

KUUSK KASVAB PÕÕSASTE

VAHEL

KESKEL

KÕRVAL – JUURES



KÕRVAL



JUURES

RÄÄGI.

LIIA ISTUB VANA+EMA

TIIT SEISAB VANA+EMA

KÕRVAL

JUURES

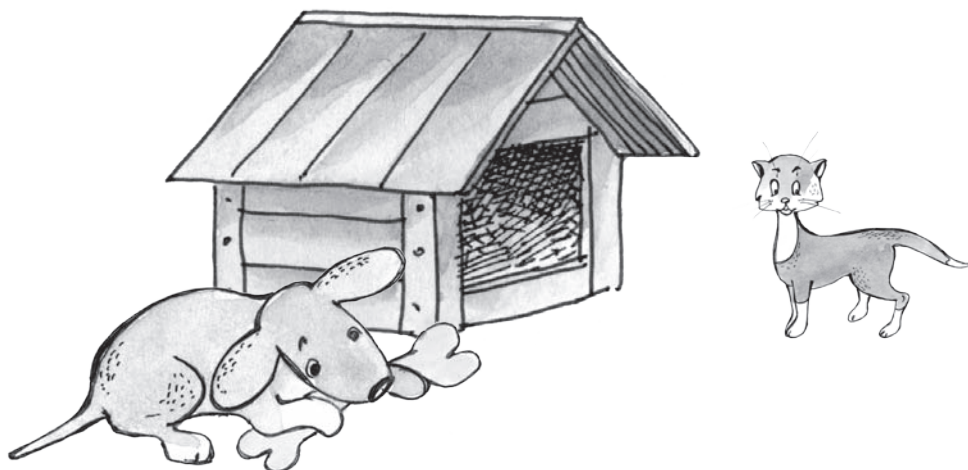

RÄÄGI.

KOER LAMAB KUUDI

KASS SEISAB KUUDI

KÕRVAL

JUURES



RÄÄGI.

UKSE KÕRVAL ON

UKSE JUURES ON

KOTT

SAAPAD

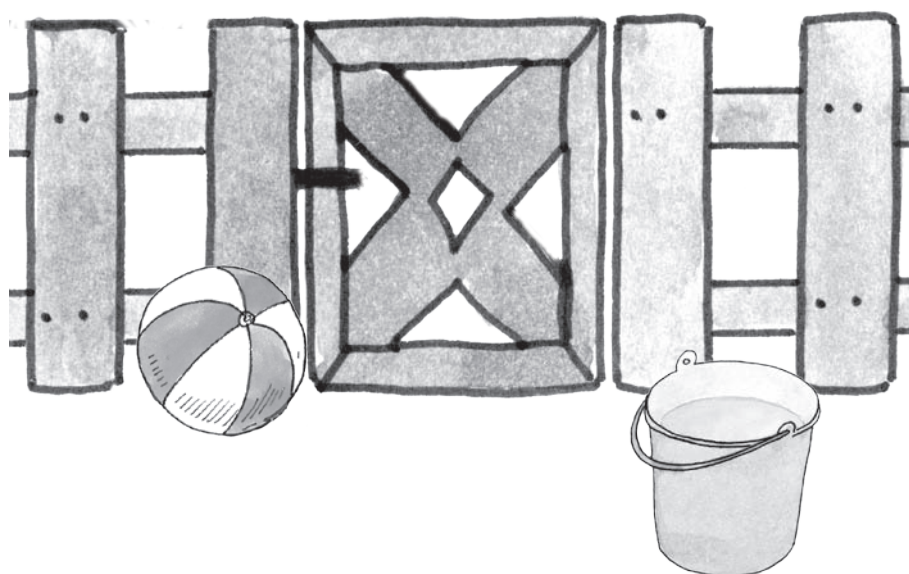

RÄÄGI.

VÄRAVA KÕRVAL ON

VÄRAVA JUURES ON

ÄMBER

PALL

KÕRVAL – KESKEL – VAHEL

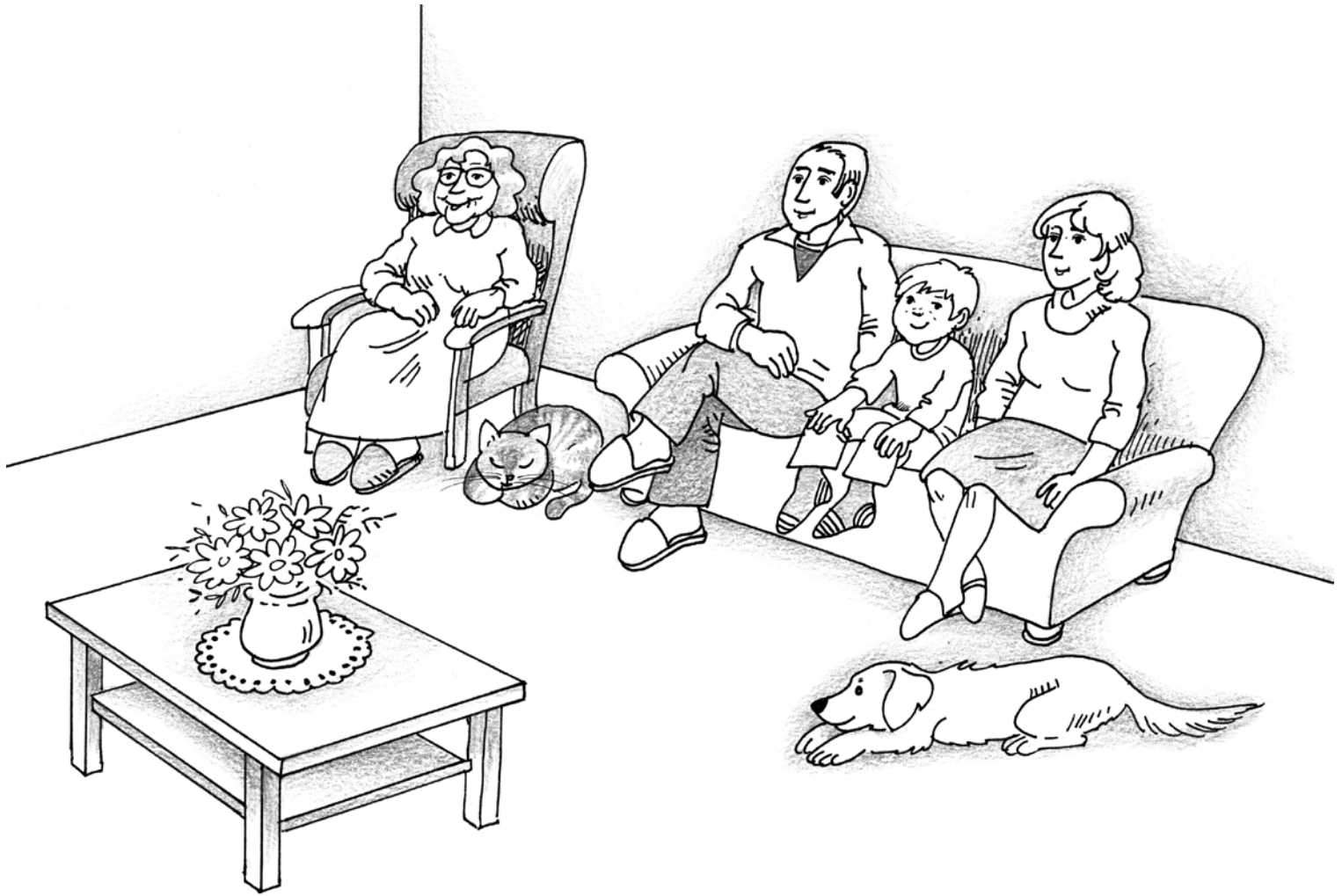

RÄÄGI.

DIIVANI KÕRVAL ON

TUGI+TOOLI KÕRVAL ON

TOA KESKEL ON

LAUA KESKEL ON

DIIVANI JUURES LAMAB

DIIVANI JA TUGITOOLI VAHEL ON

EMA KÕRVAL ISTUB

VENNA KÕRVAL ISTUB

EMA JA ISA VAHEL ISTUB

ISA KÕRVAL ISTUB

PEAL – SEES

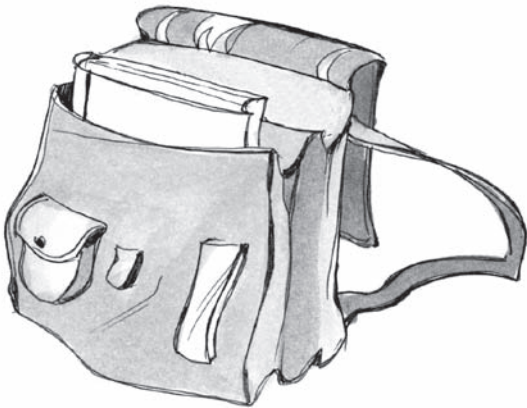

SEES



PEAL

VÄRVI.

KOTI PEAL ON SININE RAAMAT.

KOTI SEES ON KOLLANE RAAMAT.

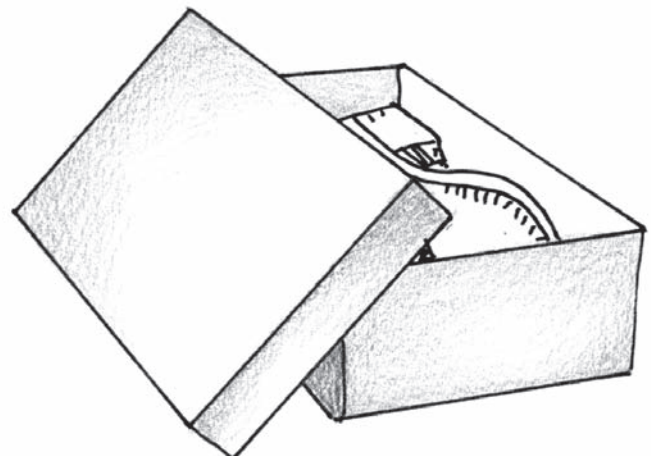
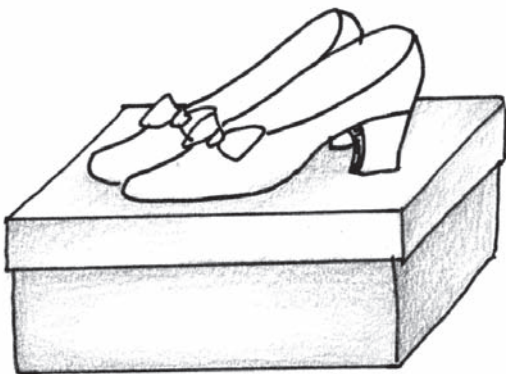

VÄRVI.

KARBI SEES ON PRUUNID KINGAD.

KARBI PEAL ON PUNASED KINGAD.

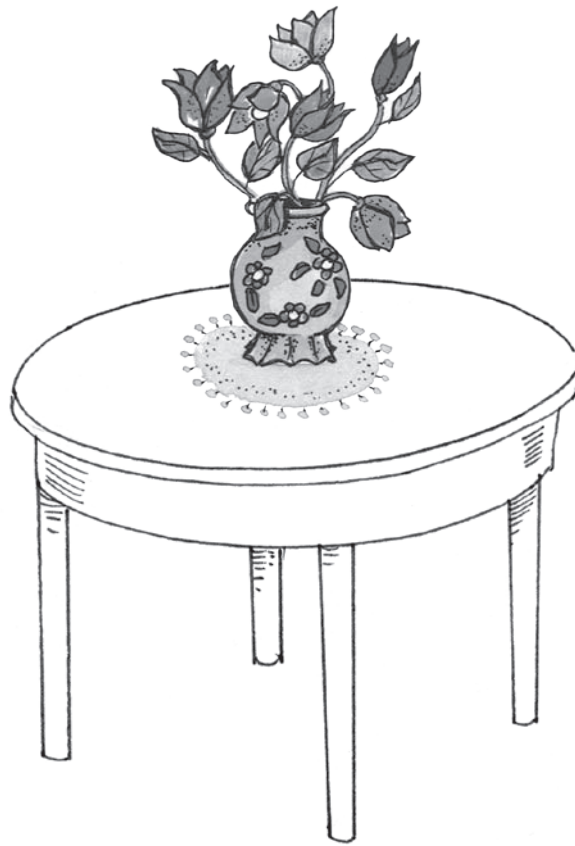

RÄÄGI.

VAAS ON LAUA

LILLED ON VAASI

SEES

PEAL

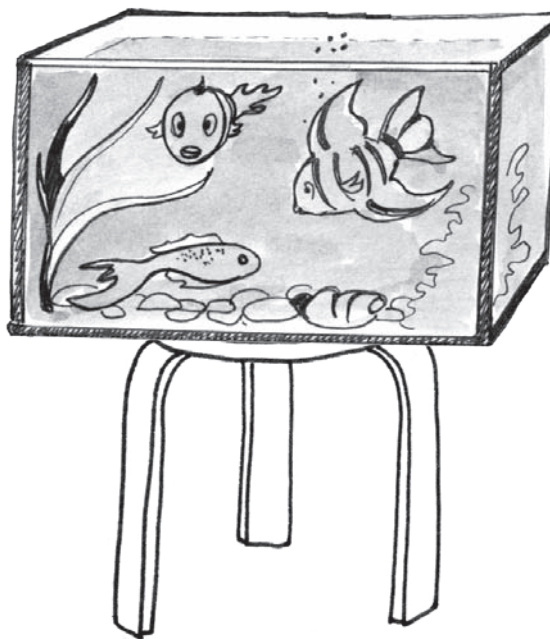

RÄÄGI.

AKVAARIUM ON TOOLI

KALAD ON AKVAARIUMI

SEES

PEAL

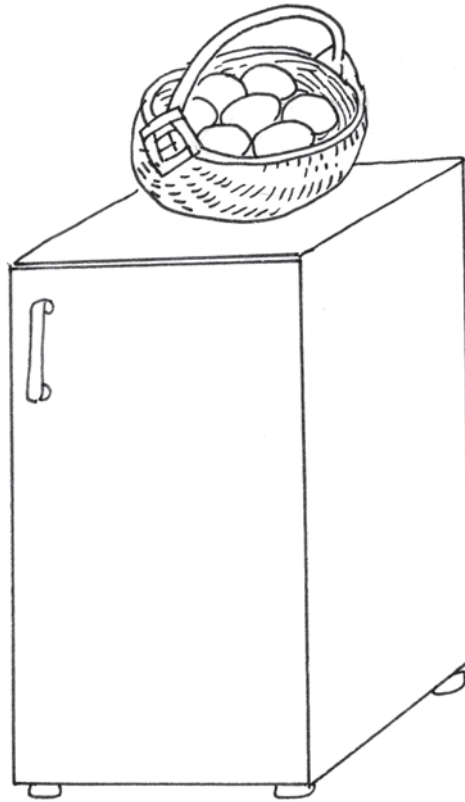

RÄÄGI.

KORV ON KAPI

MUNAD ON KORVI

SEES

PEAL

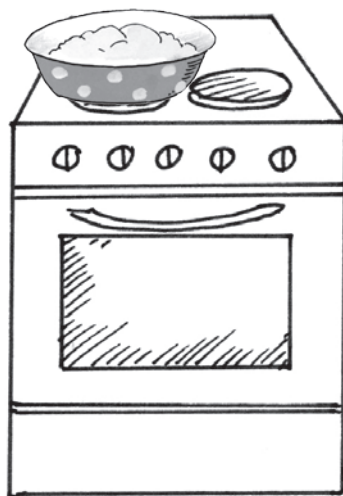

RÄÄGI.

PUDER ON KAUSI

KAUSS ON PLIIDI

SEES

PEAL

NOOR – VANA NOOREM – VANEM



NOOR

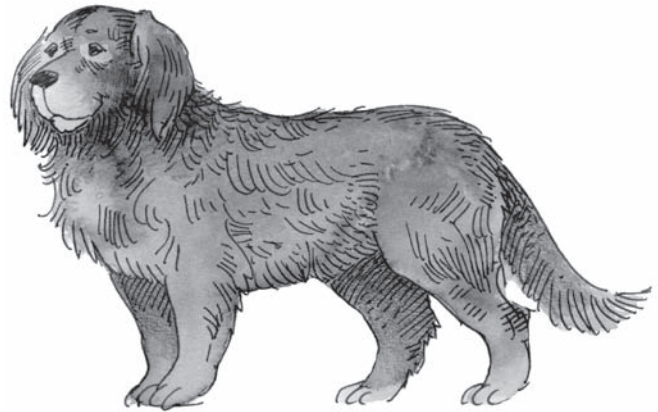

VANA

RÄÄGI.

KUTSIKAS ON

KOER ON

NOOR

VANA

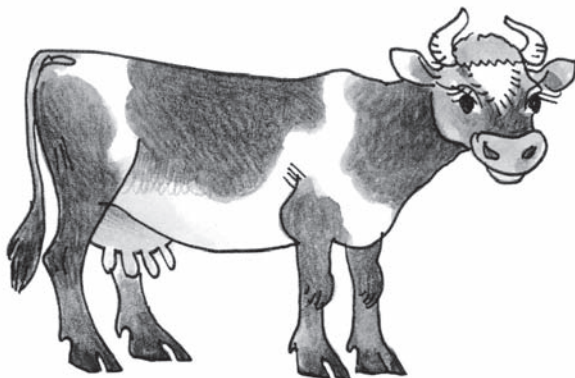

VANEM

NOOREM

RÄÄGI.

LEHM ON

VASIKAS ON

NOOR

VANA

VÖRDLE.

LEHM ON KUI VASIKAS.

VASIKAS ON KUI LEHM.

NOOREM

VANEM



RÄÄGI.

EMA ON

VANA+EMA ON

NOOR

VANA

VÖRDLE.

VANA+EMA ON KUI EMA.

EMA ON KUI VANA+EMA.

NOOREM

VANEM



VÖRDLE.

ISA ON VANEM KUI

ISA ON NOOREM KUI

VANA+ISA ON VANEM KUI

POEG

ISA

VANA+ISA

HOMMIK – LÕUNA – ÕHTU – ÖÖ

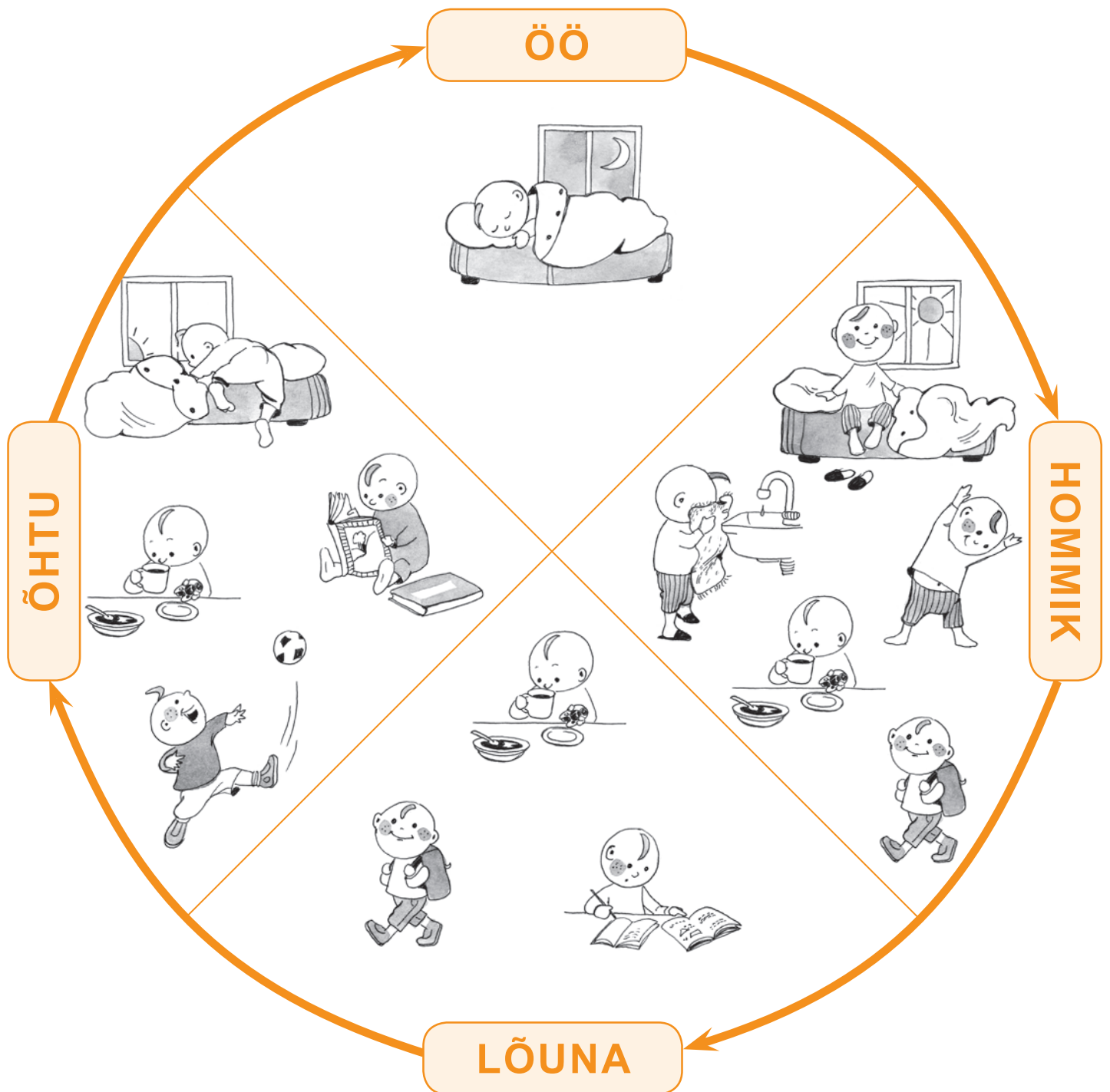

RÄÄGI.

- MA ÄRKAN
- MA LÄHEN MAGAMA
- MA MAGAN
- MA LÄHEN KOOLI
- MA TULEN KOOLIST

- HOMMIKUL
- LÕUNA AJAL
- ÕHTUL
- ÖÖSEL

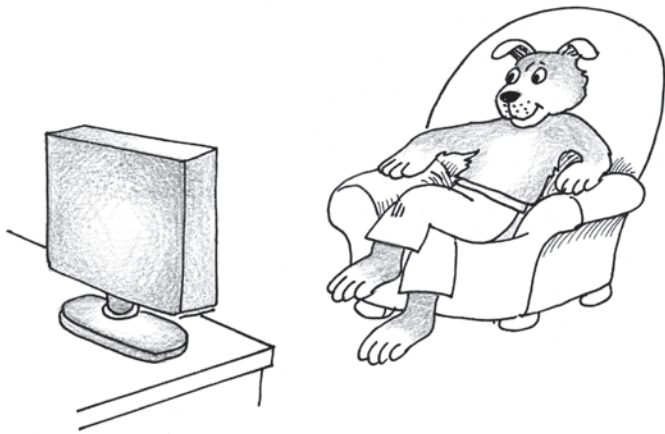

ÕHTUL

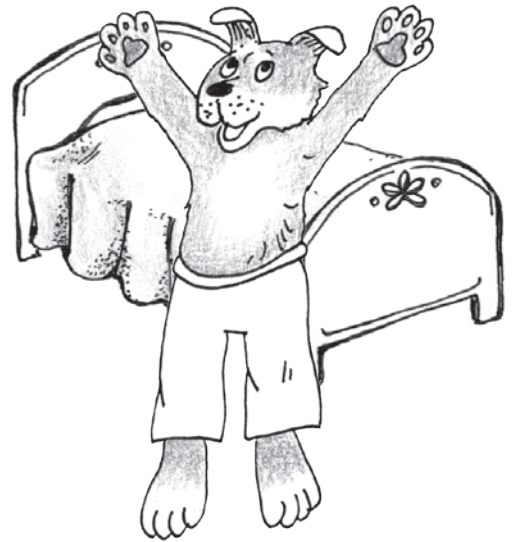

HOMMIKUL

VÄRVI.

ÕHTUL OLID MURIL JALAS PUNASED PÜKSID.

HOMMIKUL OLID MURIL JALAS SINISED PÜKSID.



VÄRVI.

PÄEVAL OLI MIISUL SELJAS ROHELINE PLUUS.

ÖÖSEL OLI MIISUL SELJAS KOLLANE PLUUS.

HULK

LEIA HULGAD. PIIRA HULK JOONEGA.

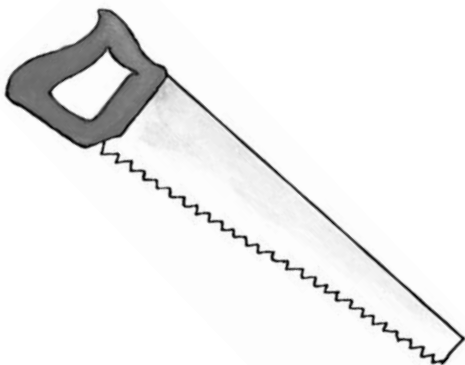

KRIIPSUTA MAHA ESEMED, MIS EI SOBI HULKA.

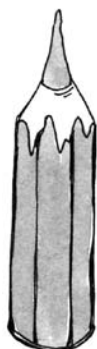
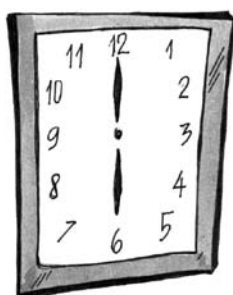

PIIRA JOONEGA ESEMED, MIS SOBIVAD ÜHTE HULKA.

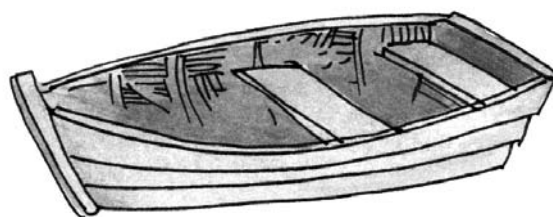
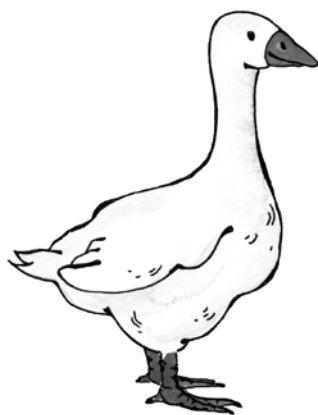
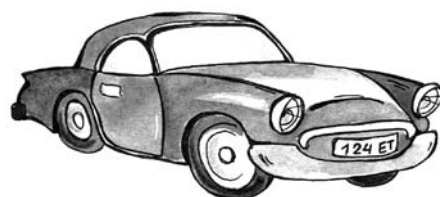
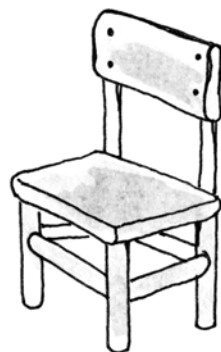
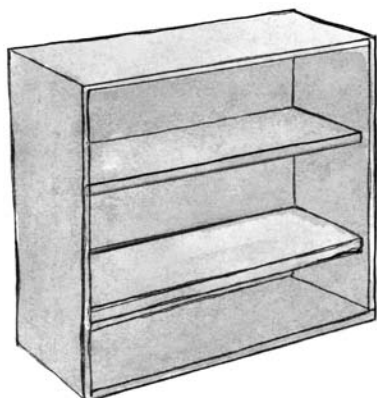

PIIRA JOONEGA TÜDRUKUD.

PIIRA JOONEGA POISID.



PIIRA JOONEGA RAAMATUD.

PIIRA JOONEGA PIIATSID.

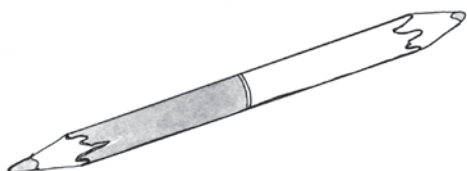

PIIRA JOONEGA BUSSID.

PIIRA JOONEGA AUTOD.

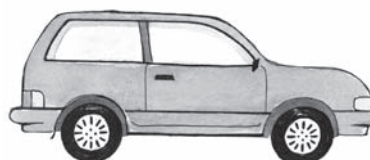
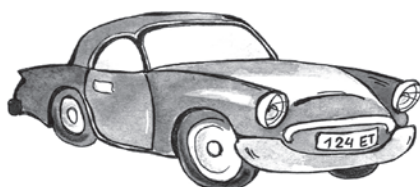

PIIRA JOONEGA SUURED MAASIKAD.
VÄRVI VÄIKESED MAASIKAD.



PIIRA JOONEGA KÕRGED PUUD.
VÄRVI MADALAD PUUD.

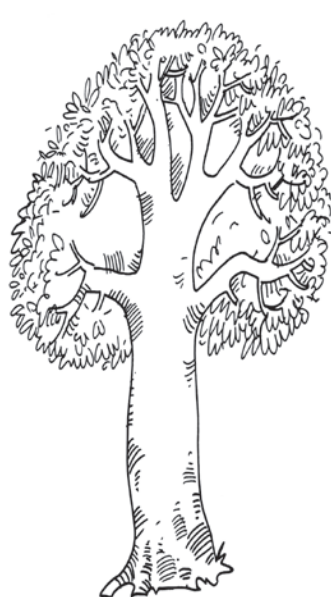

PIIRA JOONEGA LÜHIKESED PÜKSID.
VÄRVI PIKAD PÜKSID.



PIIRA JOONEGA SIILID. **VÄRVI** JÄNESED.

PIIRA JOONEGA METS+LOOMAD.

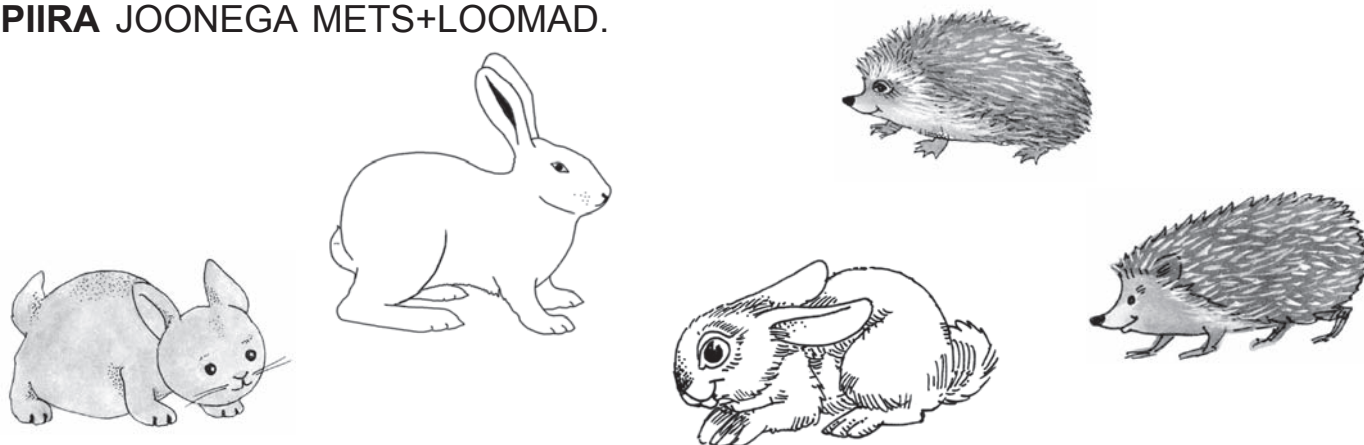

PIIRA JOONEGA KAPSAD. **VÄRVI** TOMATID.

PIIRA JOONEGA AED+VILJAD.

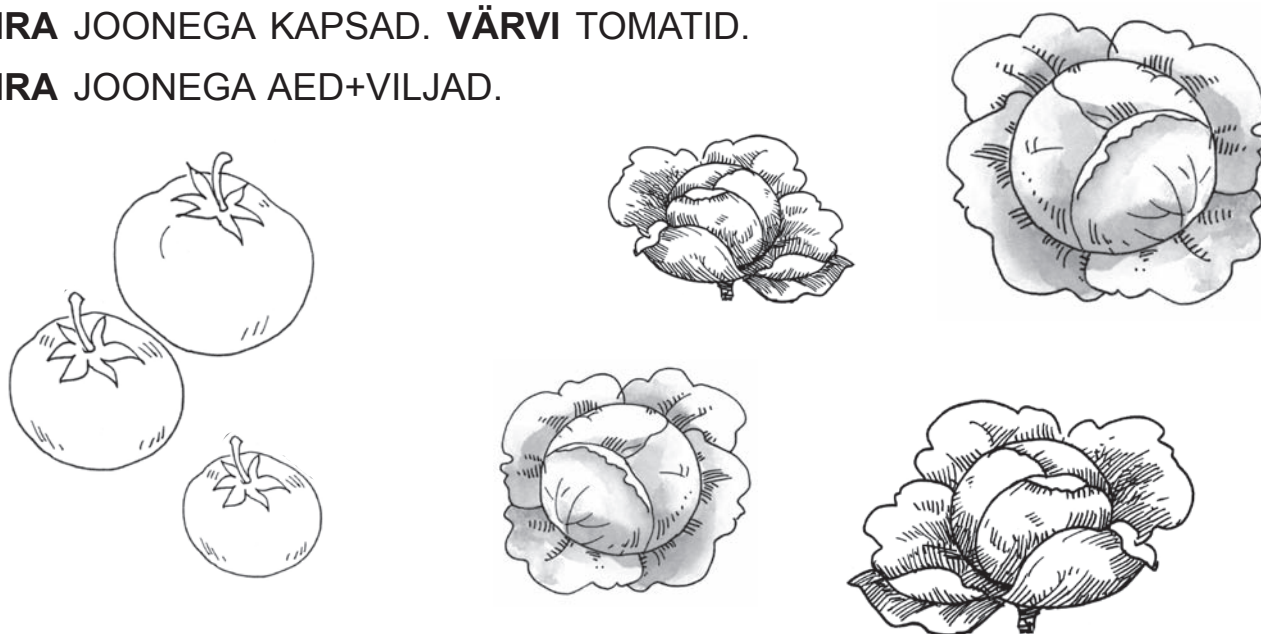

PIIRA JOONEGA KINGAD. **VÄRVI** SAAPAD.

PIIRA JOONEGA JALATSID.



ÜHENDA JOONEGA NEED, MIS KUULUVAD KOKKU.

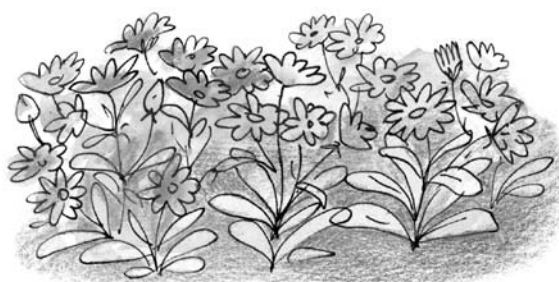
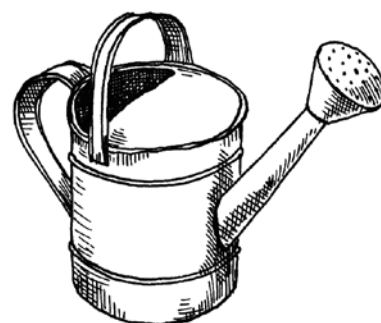
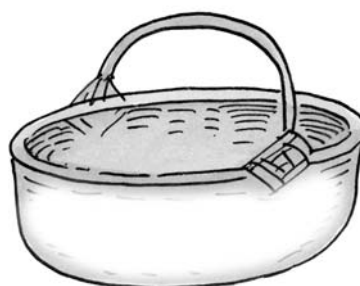
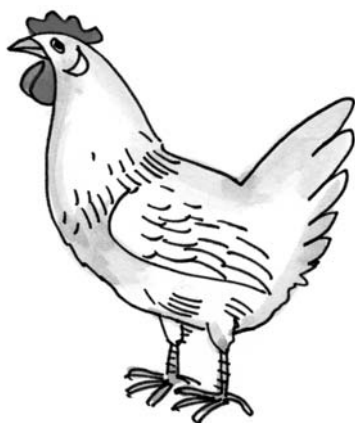
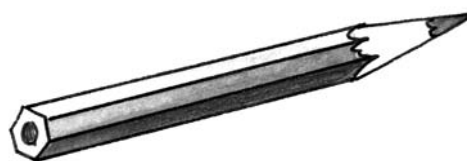
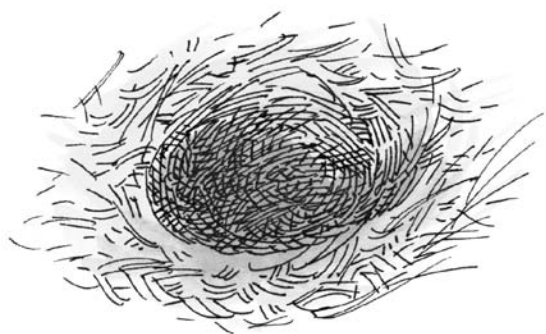

ÜHENDA JOONEGA SOBIV SÕIDUK JA SÕIDUKI JUHT.

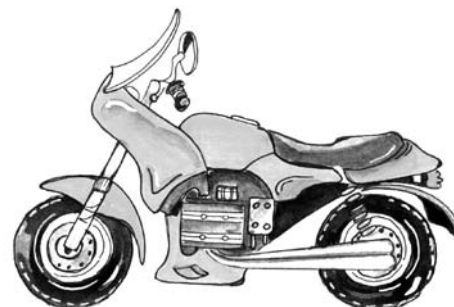
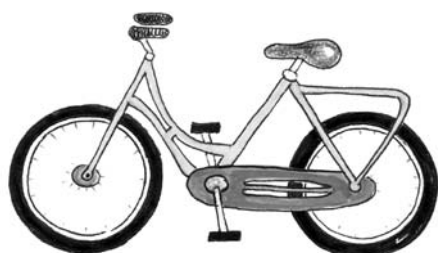

LEIA SOBIV PEA+KATE. ÜHENDA JOONEGA.



LEIA AMETILE SOBIV TÖÖ+VAHEND. ÜHENDA JOONEGA.

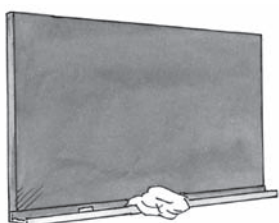

ÜHENDA JOONEGA KANN JA KLAAS.



KANNE ON **NII+SAMA PALJU** KUI KLAASE.

KANNUDES ON PLOOMI+MAHL, TOMATI+MAHL JA APELSINI+MAHL.
VÄRVI MAHL KANNUS JA KLAASIS.

ÜHENDA JOONEGA TASS JA TALDRIK.



TASSE ON KUI TALDRIKUID.

VÄRVI TASS JA TALDRIK SAMA VÄRVI.

ÜHENDA JOONEGA KALA+MEES JA KALA.



RÄÄGI. KALU ON **ROHKEM**.
KALA+MEHI ON **VÄHEM**.

ÜHENDA JOONEGA KOOLI+KOTT JA KOOLI+LAPS.

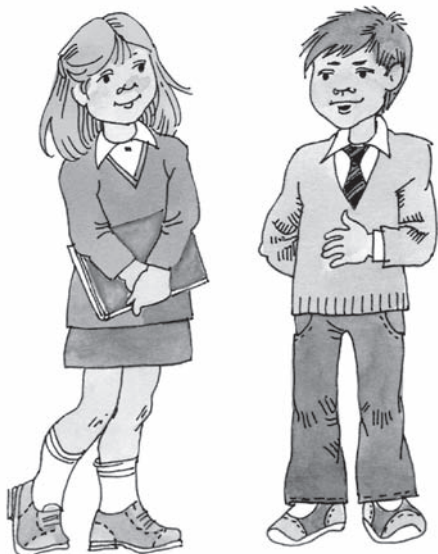

RÄÄGI. KOTTE ON
LAPSI ON

ROHKEM
VÄHEM

ÜHENDA JOONEGA TELEFON JA POISS.



RÄÄGI. TELEFONE ON
POISSE ON

ROHKEM
VÄHEM

ÜHENDA JOONEGA KASS JA HIIR.



RÄÄGI. HIIRI ON
KASSE ON

ROHKEM
VÄHEM

ÜHENDA JOONEGA PUDEL JA KLAAS.

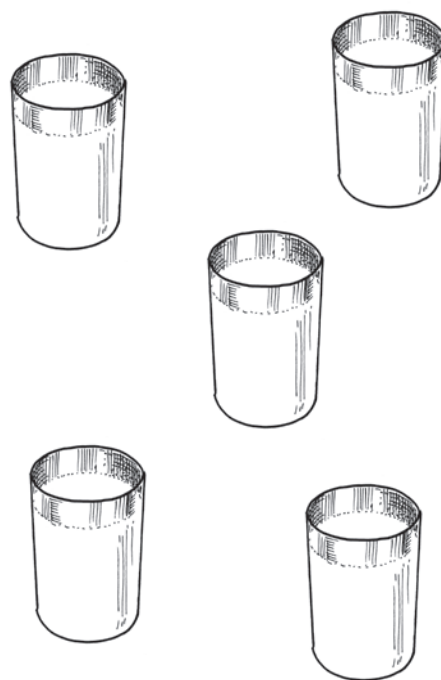
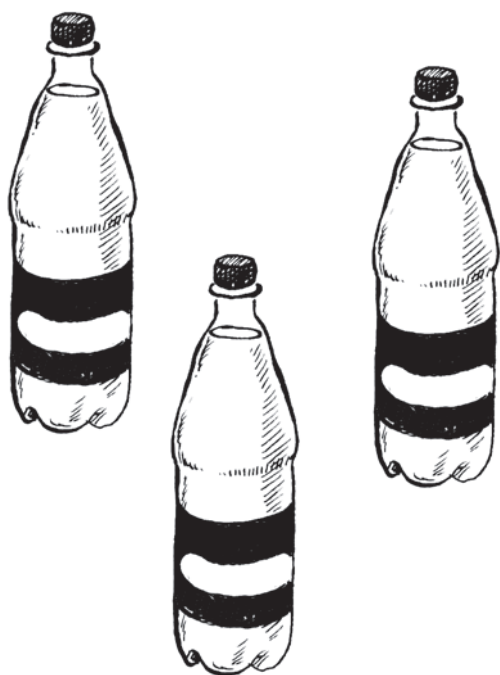

VÖRDLE.

PUDELEID ON KUI KLAASE.

ROHKEM

VÄHEM

ÜHENDA JOONEGA TÜDRUK JA JÄÄTIS.

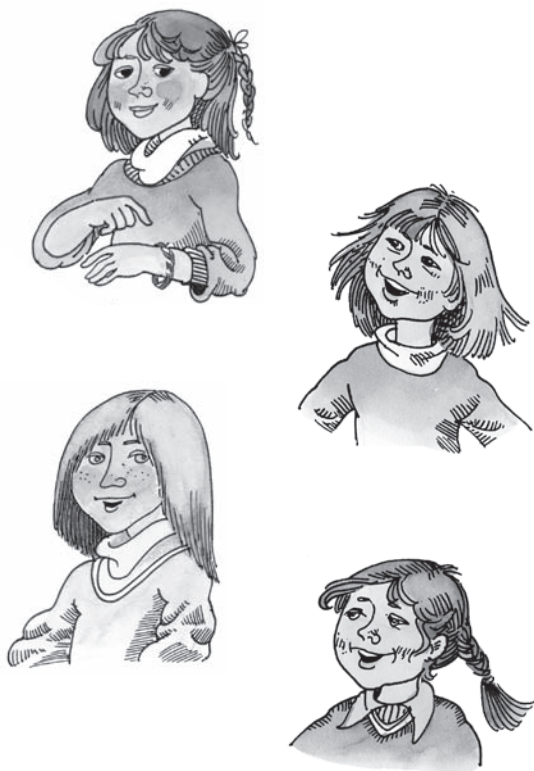
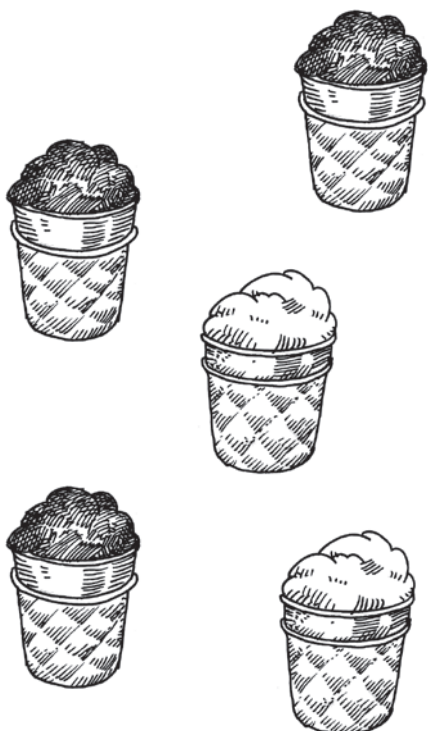

VÖRDLE.

TÜDRUKUID ON KUI JÄÄTISEID.

ROHKEM

VÄHEM

ÜHENDA JOONEGA LIBLIKAS JA LILL.



VÖRDLE.

LIBLIKAID ON KUI LILLI.

ROHKEM

VÄHEM

ÜHENDA JOONEGA MESI+TARU JA KARU.

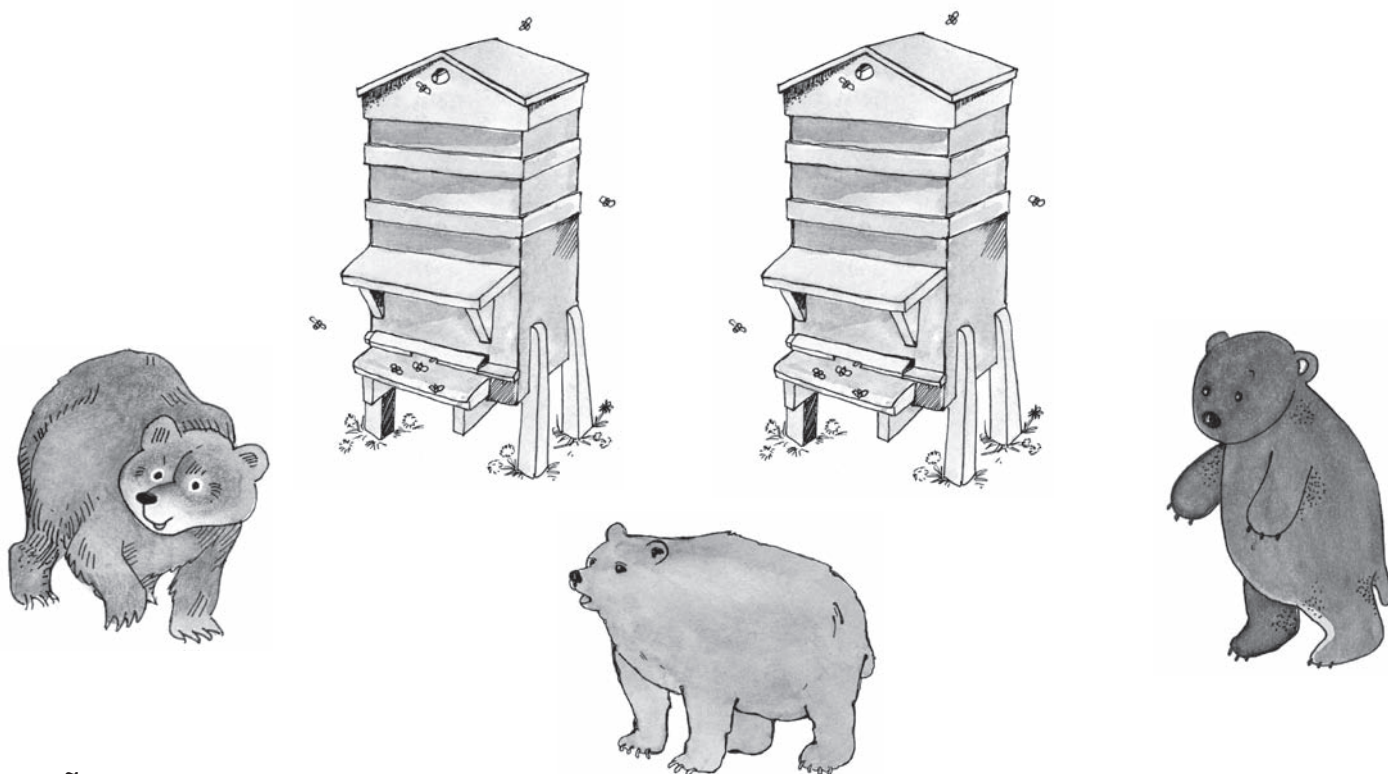

VÖRDLE.

MESI+TARUSID ON KUI KARUSID.

ROHKEM

VÄHEM

ÜHENDA JOONEGA PALL JA POISS.



RÄÄGI. PALLE ON
POISSE ON

ROHKEM
VÄHEM

JOONISTA IGALE LAPSELE PALL.

VÖRDLE.
NÜÜD ON PALLE KUI POISSE.

ROHKEM
VÄHEM
NII+SAMA PALJU

ÜHENDA JOONEGA ÕUN JA ÕUNA+USS.

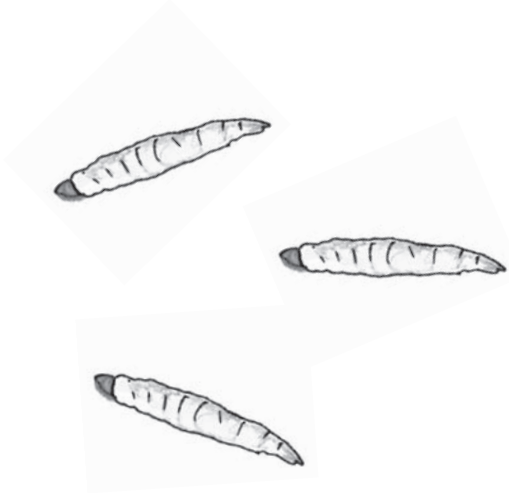

RÄÄGI. ÕUNU ON
USSE ON

ROHKEM
VÄHEM

JOONISTA IGALE USSILE ÕUN.

VÖRDLE.
NÜÜD ON ÕUNU KUI USSE.

ROHKEM
VÄHEM
NII+SAMA PALJU

ÜHENDA JOONEGA SUUR JA VÄIKE NÖÖP.



VÖRDLE.

SUURI NÖÖPE ON KUI VÄIKSEID NÖÖPE.

VÄIKSEID NÖÖPE ON KUI SUURI NÖÖPE.

ROHKEM

VÄHEM

JOONISTA JUURDE NII PALJU NÖÖPE, ET SUURI JA VÄIKSEID NÖÖPE OLEKS SAMA PALJU.

ÜHENDA JOONEGA PIKK JA LÜHIKE NAEL.



VÖRDLE.

PIKKI NAELU ON KUI LÜHIKESI NAELU.

LÜHIKESI NAELU ON KUI PIKKI NAELU.

ROHKEM

VÄHEM

JOONISTA JUURDE NIIPALJU NAELU, ET PIKKI JA LÜHIKESI NAELU OLEKS SAMA PALJU.

VÄRVI NAELAD, MIS SA JUURDE JOONISTASID.

SEE ON **RING**.

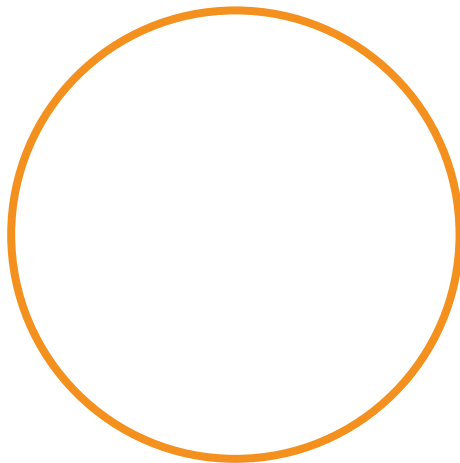

ÜHENDA JOONEGA SUUR JA VÄIKE RING.

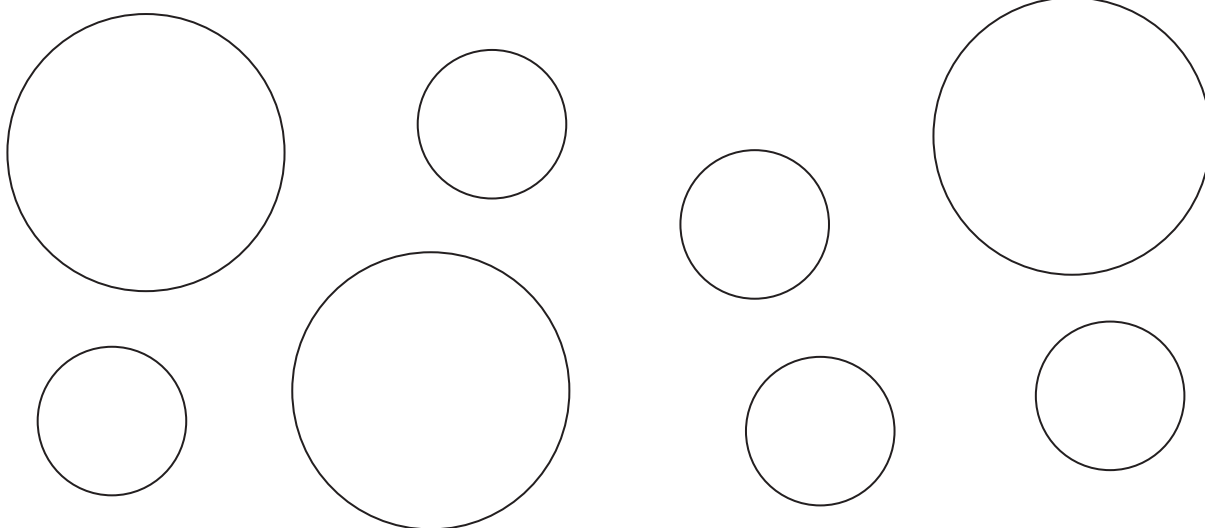

RÄÄGI. SUURI RINGE ON
VÄIKSEID RINGE ON

ROHKEM
VÄHEM

VÄRVI. SUURED RINGID ON PUNASED.
VÄIKSED RINGID ON SINISED.

RÄÄGI. SINISEID RINGE ON
PUNASEID RINGE ON

ROHKEM
VÄHEM

VÖRDLE.

SINISEID RINGE ON KUI PUNASEID RINGE.
PUNASEID RINGE ON KUI SINISEID RINGE.

ROHKEM
VÄHEM

VÄRVI RINGID SINISEKS.

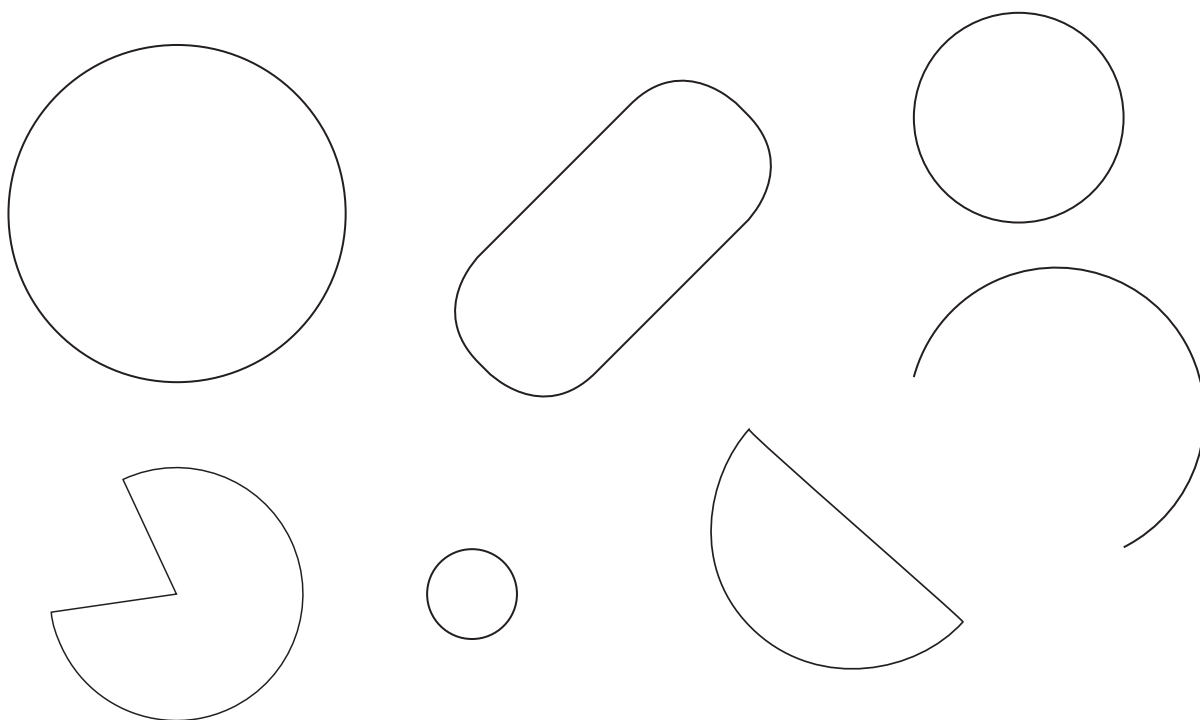

NIMETA RINGI+KUJULISED ESEMED.

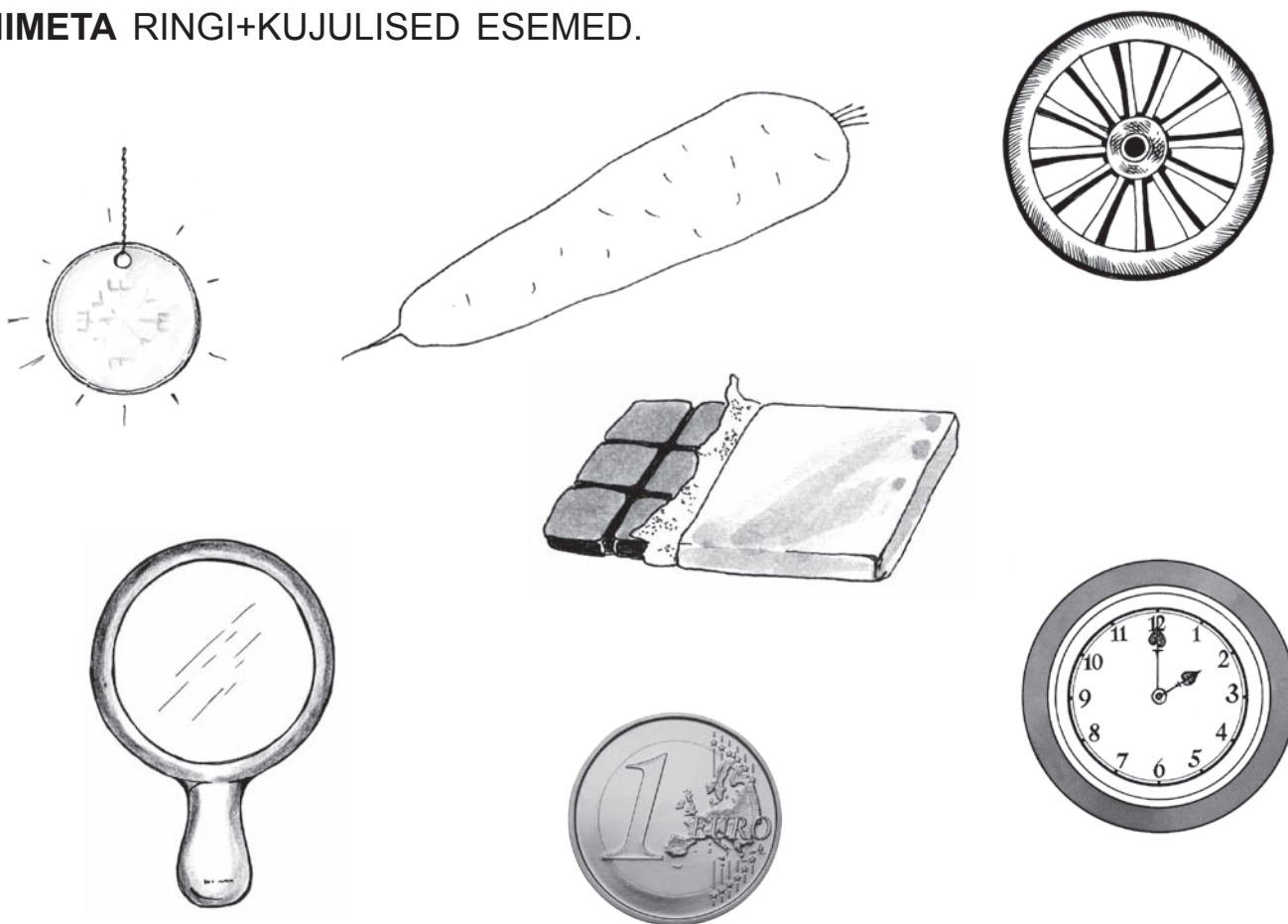

VÄRVI ESEMED, MIS EI OLE RINGI+KUJULISED.

VÄRVI KÕIGE SUUREM RING ROHELISEKS.

VÄRVI KÕIGE VÄIKSEM RING SINISEKS.

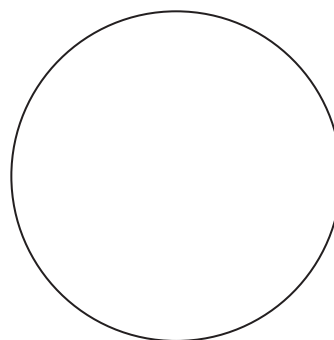
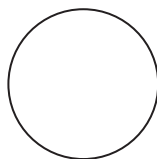
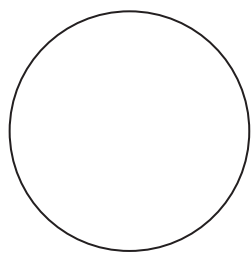

JOONISTA RINGIDELE MIDAGI JUURDE, NII ET SAAKSID PILDI.

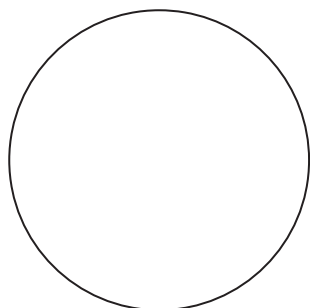

PÄIKE

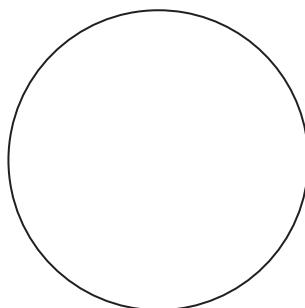

NÖÖP

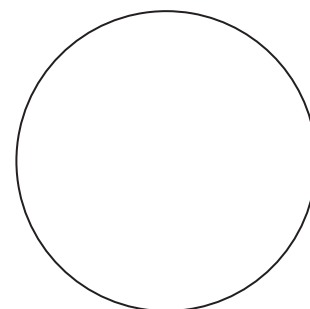

MULLI+POISS

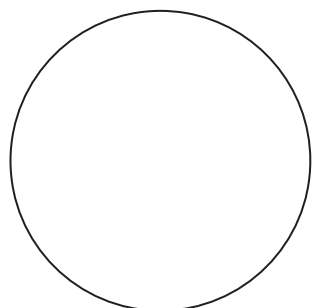

ÕUN

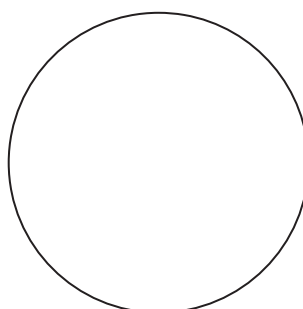

PALL

LÕPETA RIDA.

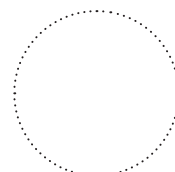
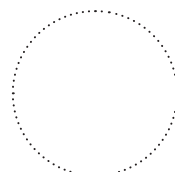
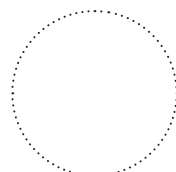
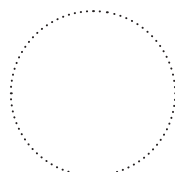
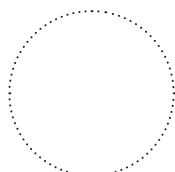
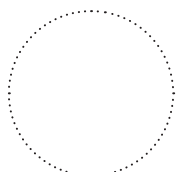
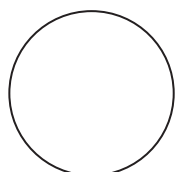

ÜHENDA RING JA ESE JOONEGA.

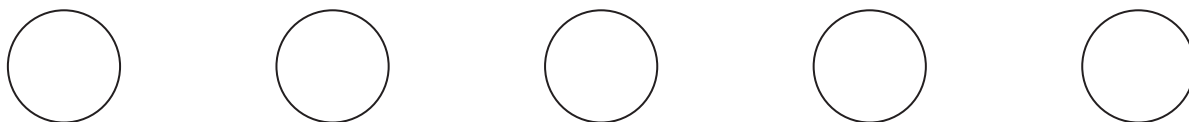
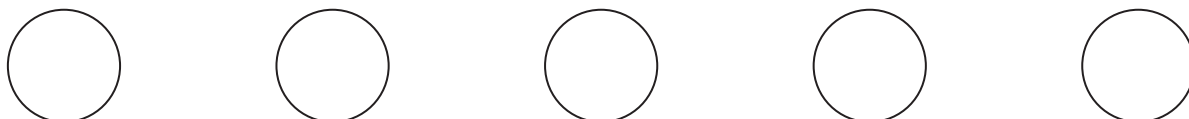
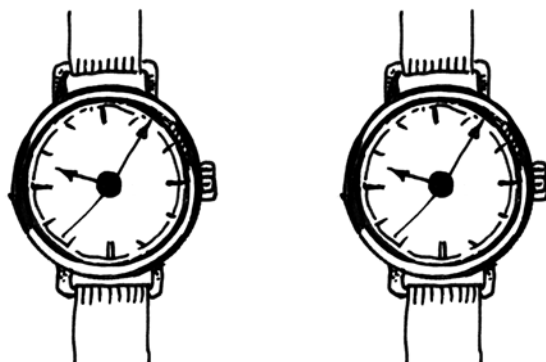
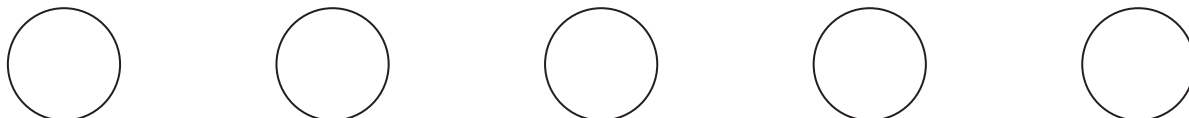

VÄRVI NII+SAMA PALJU RINGE, KUI ON ESEMEID.

LEIA JA VÄRVI KUJUNDID, MIS EI SOBI RINGIDE HULKA.

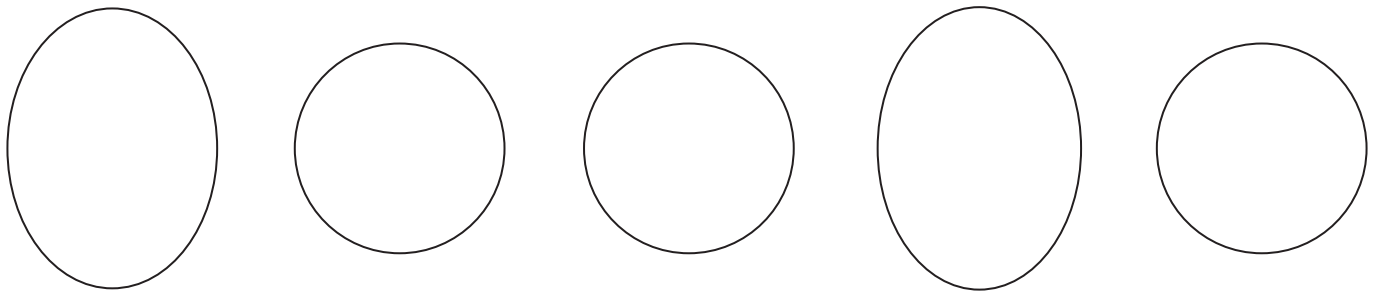
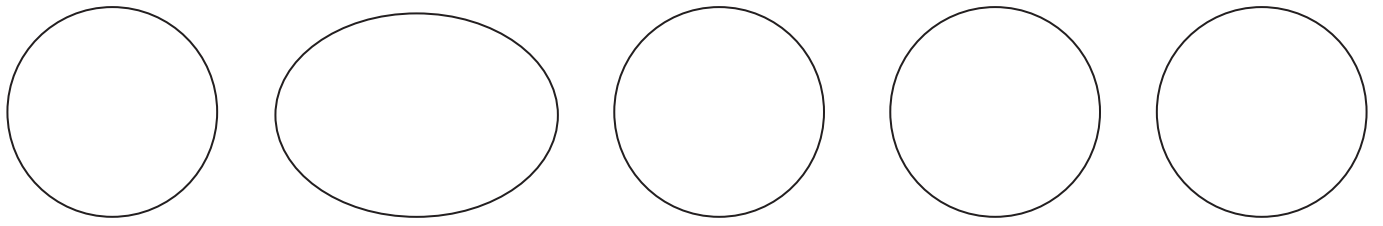

VÄRVI NII+SAMA PALJU RINGE, KUI ON PILDIL.

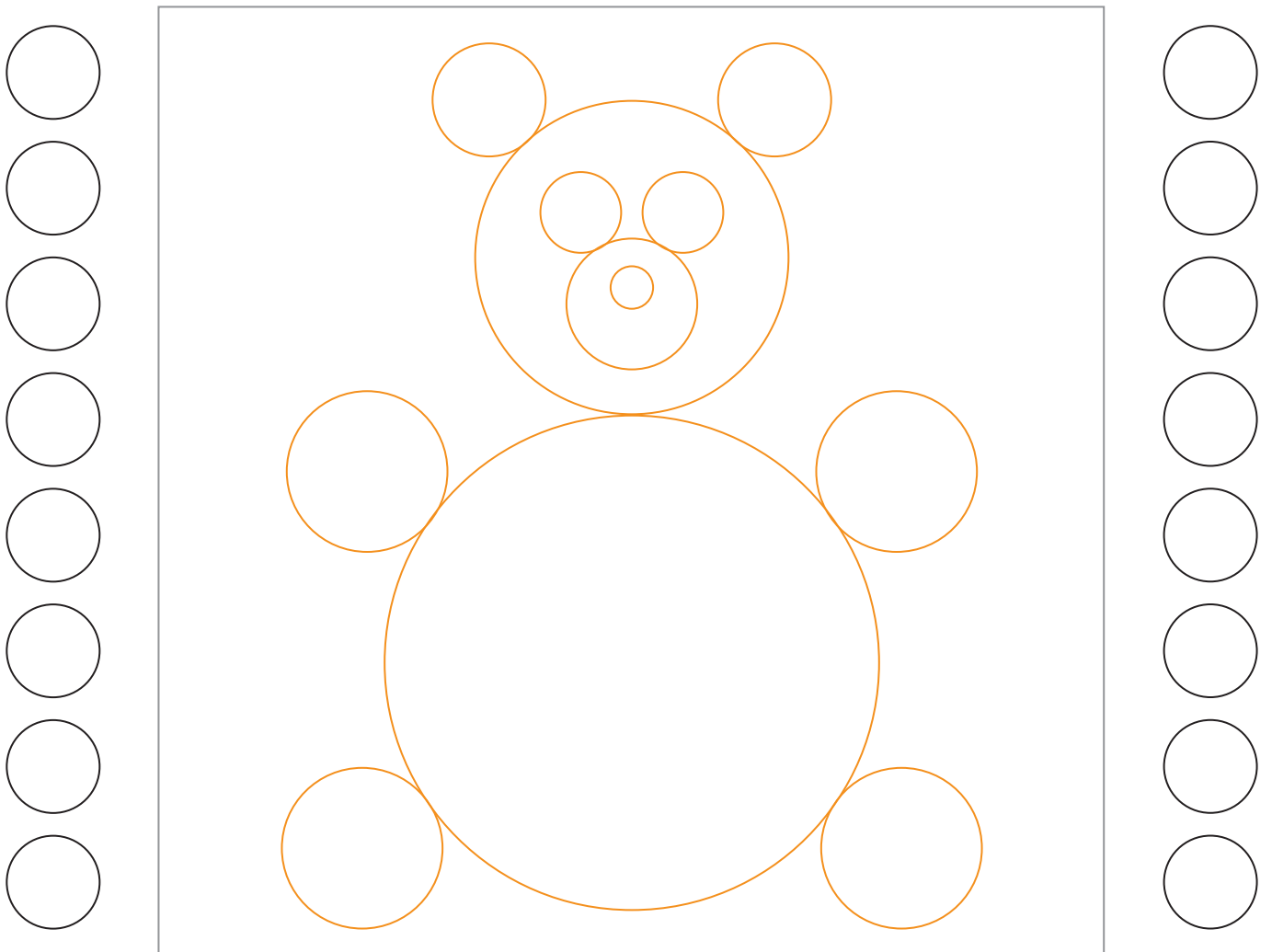

SEE ON **RUUT**.



ÜHENDA JOONEGA SUUR JA VÄIKE RUUT.

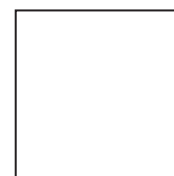
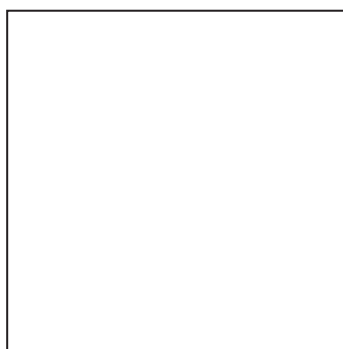
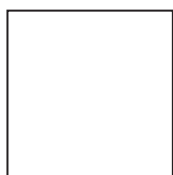
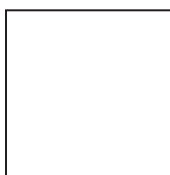
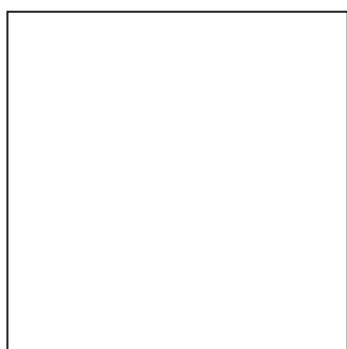

RÄÄGI. SUURI RUUTE ON
VÄIKSEID RUUTE ON

ROHKEM
VÄHEM

VÄRVI. SUURED RUUDUD ON ROHELISED.
VÄIKSED RUUDUD ON KOLLASED.

RÄÄGI. KOLLASEID RUUTE ON
ROHELISI RUUTE ON

ROHKEM
VÄHEM

VÄRVI RUUDUD ROHELISEKS.

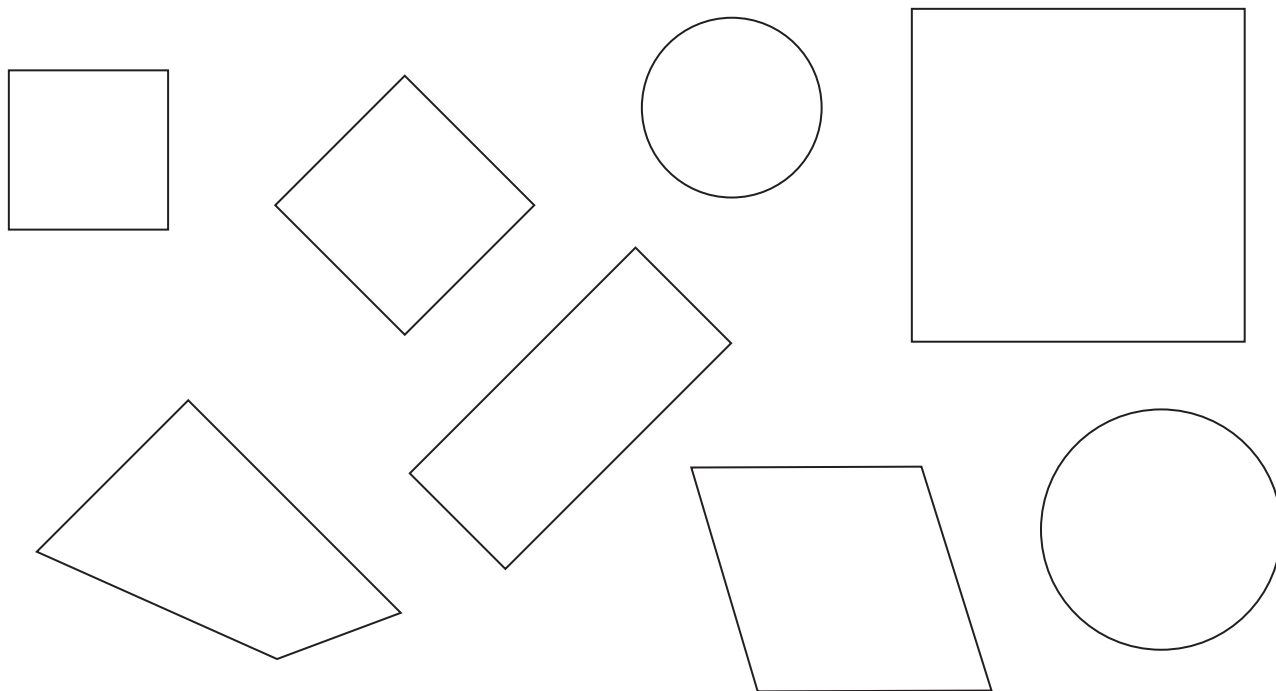

NIMETA RUUDU+KUJULISED ESEMED.



VÄRVI NEED ESEMED, MIS ON RUUDU+KUJULISED.

VÄRVI KÕIGE SUUREM RUUT PUNASEKS.

VÄRVI KÕIGE VÄIKSEM RUUT SINISEKS.

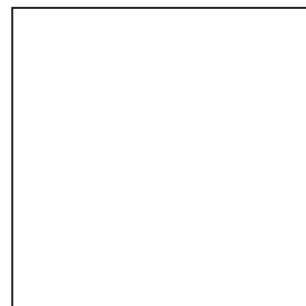
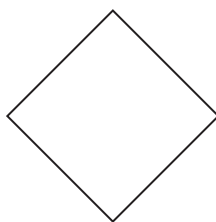
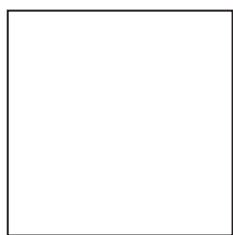

JOONISTA RUUTUDELE MIDAGI JUURDE, NII ET SAAKSID PILDI.

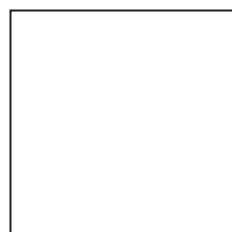
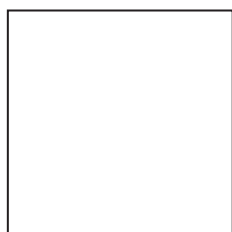
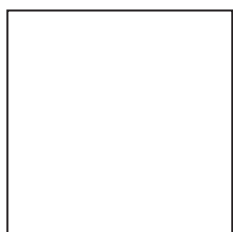

MAJA

MASK

AKEN

KAPP

VÄRVI KUJUNDID, MIS EI SOBI HULKA.

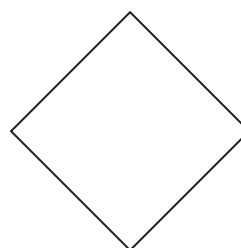
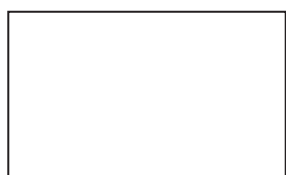
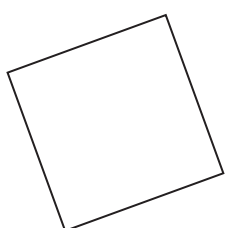
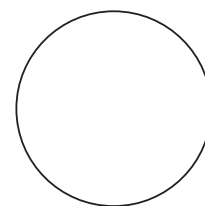
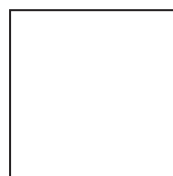
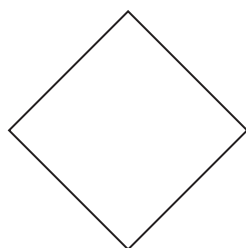
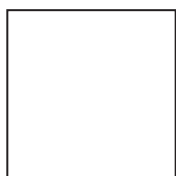

ÜHENDA RUUT JA ESE JOONEGA.

VÄRVI NII+SAMA PALJU RUUTE.

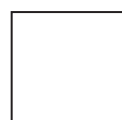
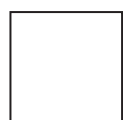
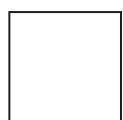
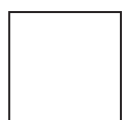
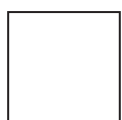
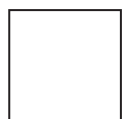
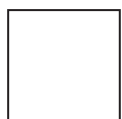
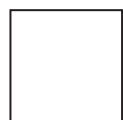
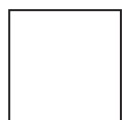
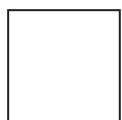

VÄRVI NII+PALJU KUJUNDEID, KUI ON PILDIL.

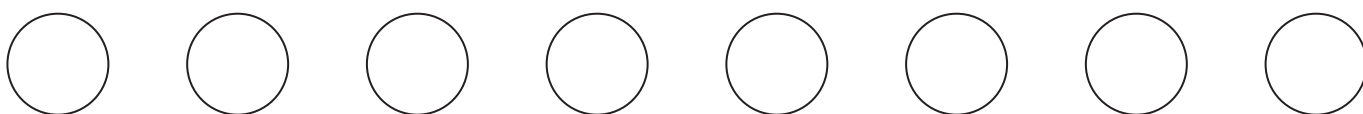
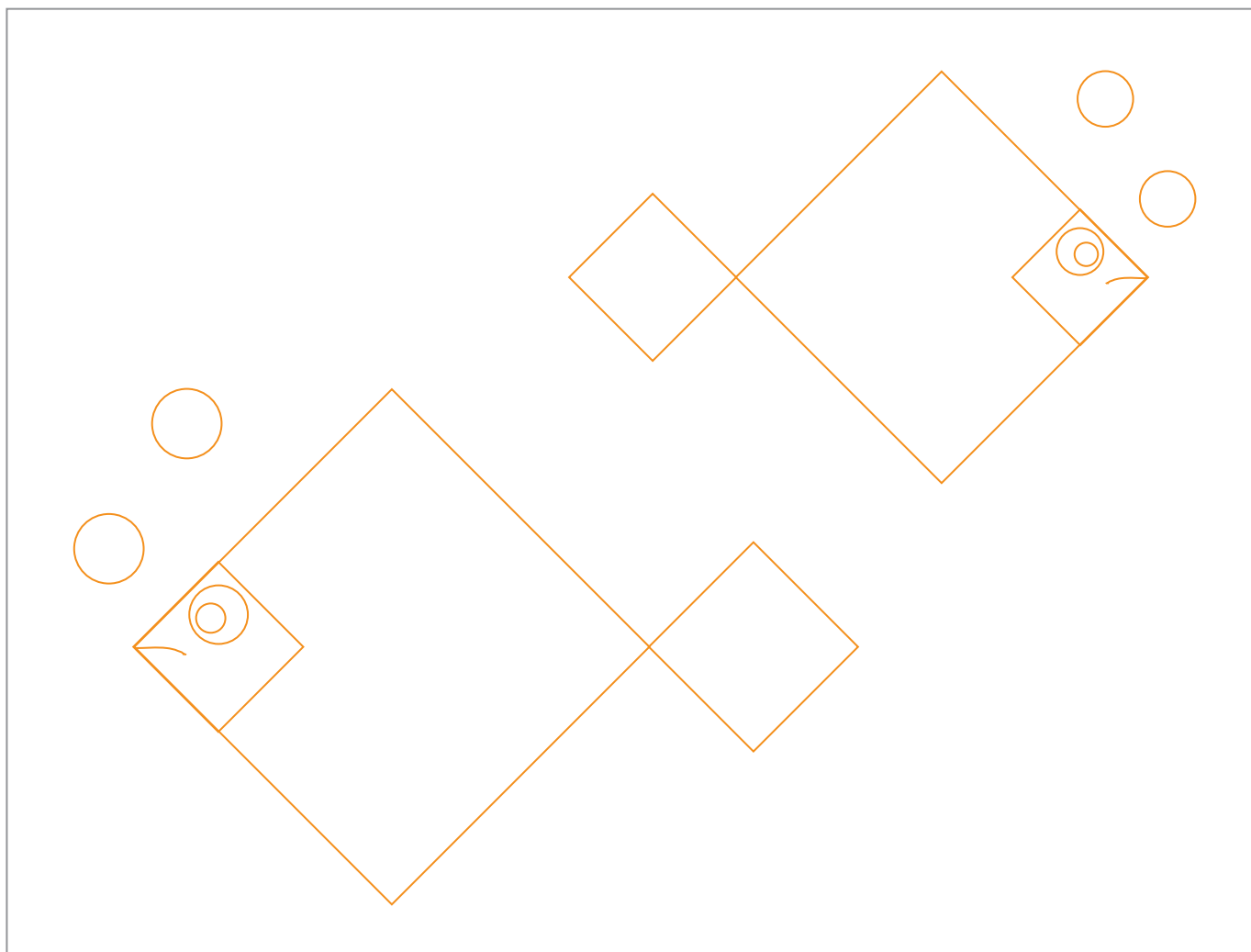
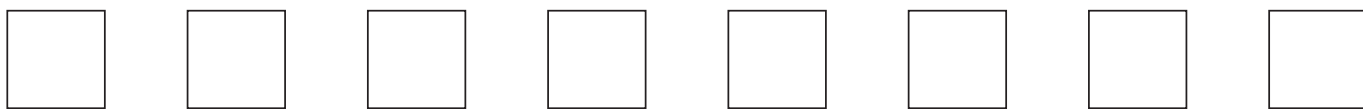

JOONISTA RUUDUD.



SEE ON **KOLM+NURK**.



ÜHENDA JOONEGA SUUR JA VÄIKE KOLM+NURK.

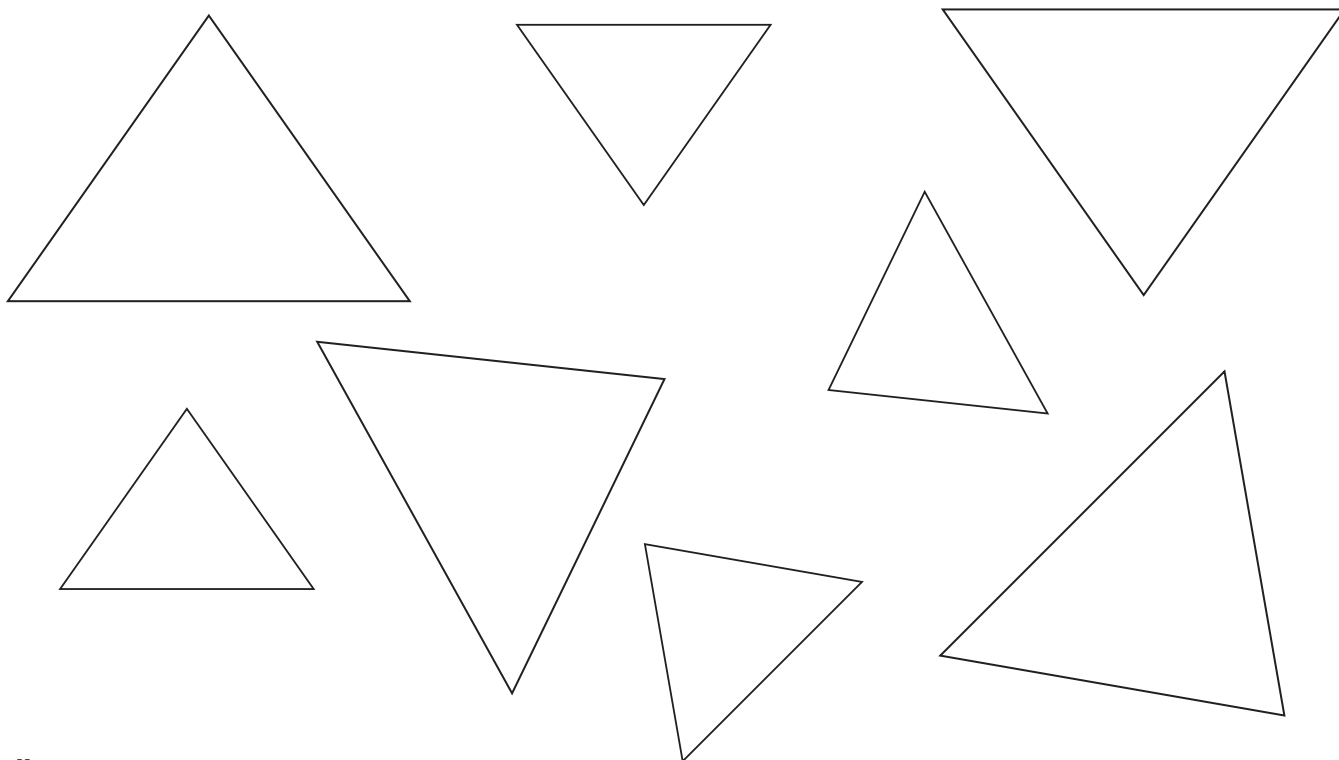

VÄRVI.

SUURED KOLM+NURGAD ON ROHELISED.

VÄIKSED KOLM+NURGAD ON PUNASED.

VÖRDLE.

SUURI KOLM+NURKI ON KUI

VÄIKSEID KOLM+NURKI.

ROHELISI KOLM+NURKI ON KUI

PUNASEID KOLM+NURKI.

ROHKEM

NII+SAMA PALJU

VÄHEM

VÄRVI KOLM+NURGAD KOLLASEKS.

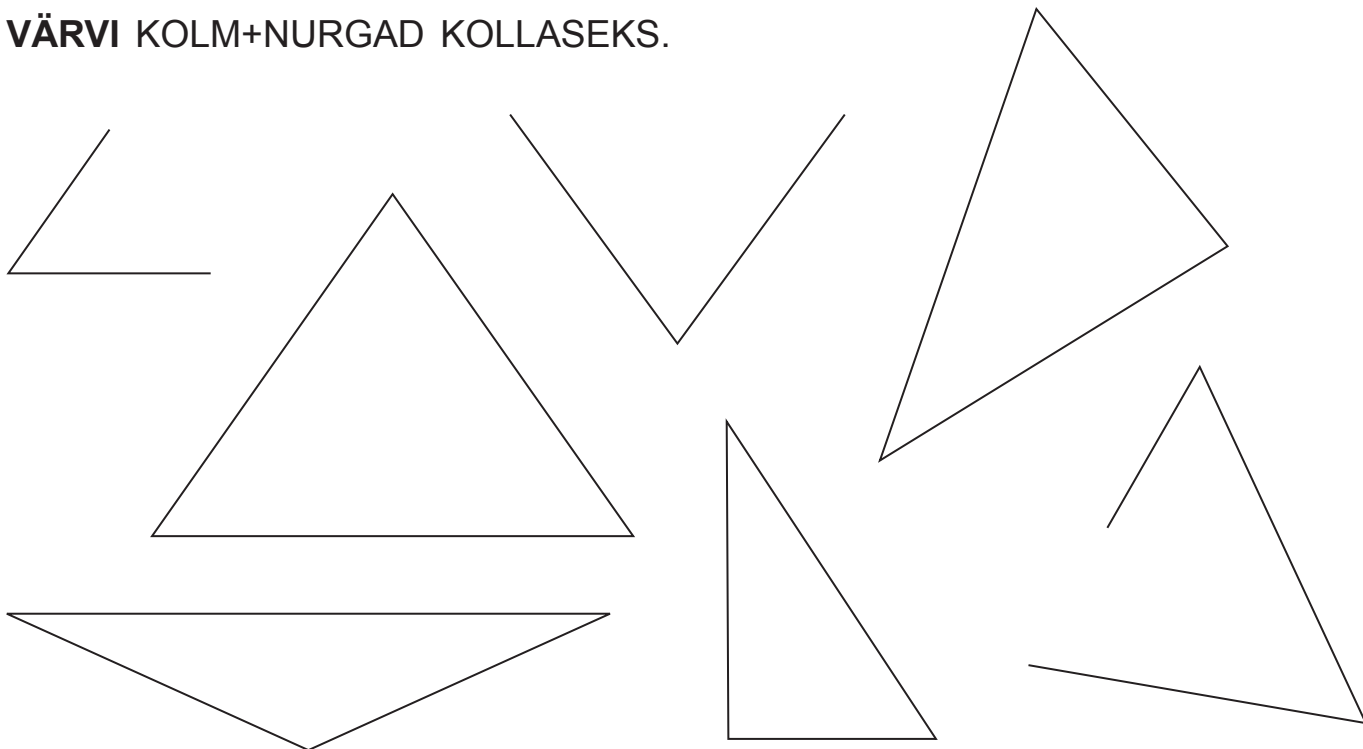

NIMETA KOLM+NURGA+KUJULISED ESEMED. VÄRVI.

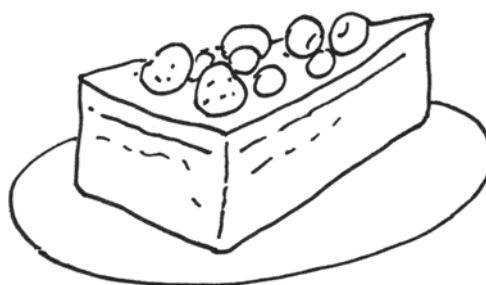
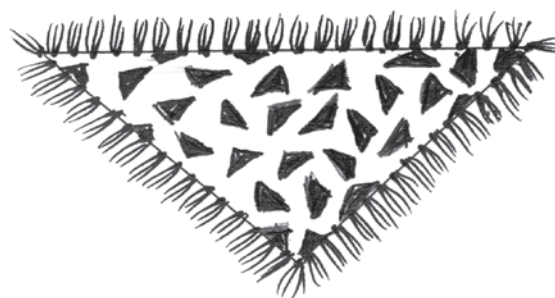
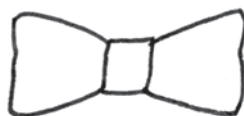
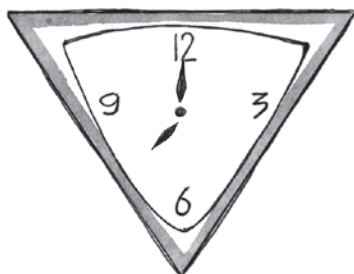

VÄRVI KÕIGE SUUREM KOLM+NURK KOLLASEKS.

VÄRVI KÕIGE VÄIKSEM KOLM+NURK SINISEKS.



JOONISTA KOLM+NURKADELE MIDAGI JUURDE, NII ET SAAKSID PILDID.

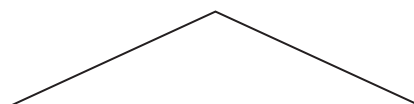
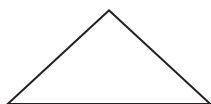
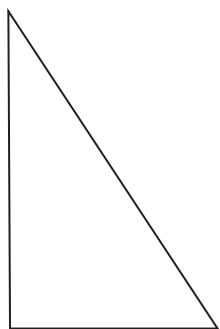

PURJEKAS

KUUSK

MAJA

VÄRVI KUJUNDID, MIS EI SOBI HULKA.

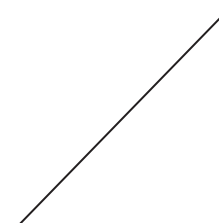
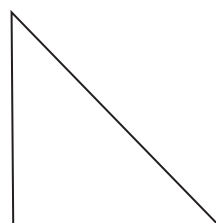
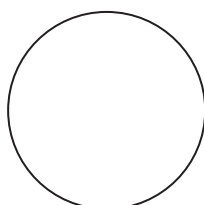
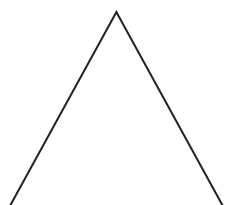
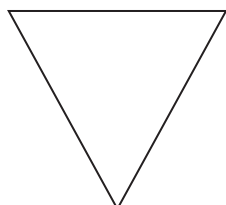
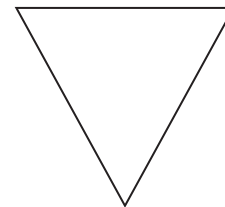
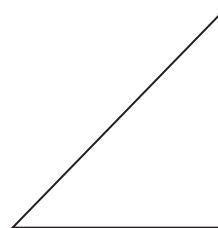
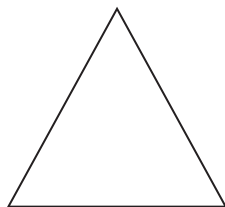
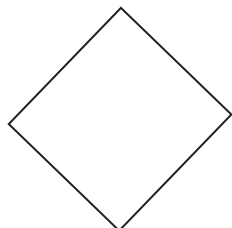
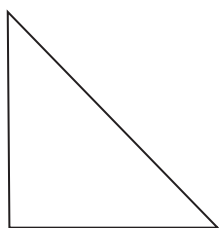

ÜHENDA ESE JA KOLM+NURK JOONEGA.

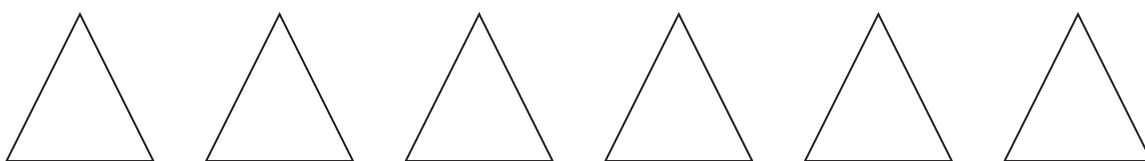
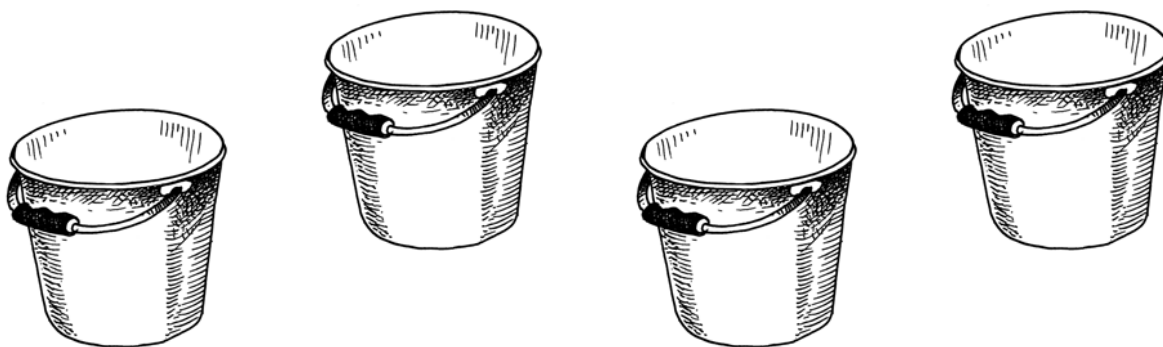
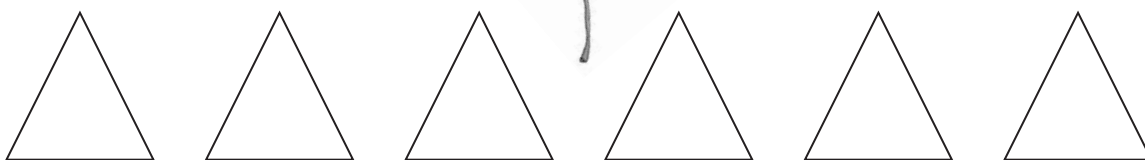
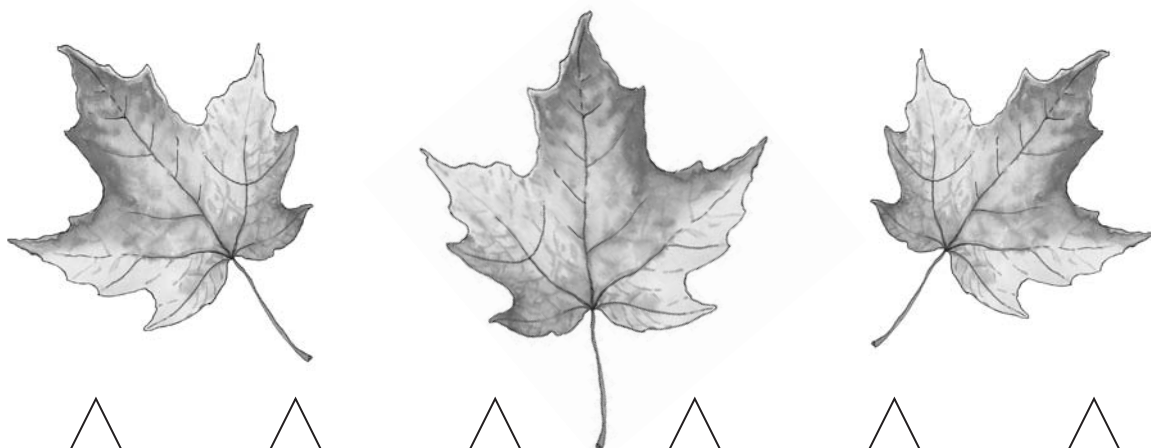
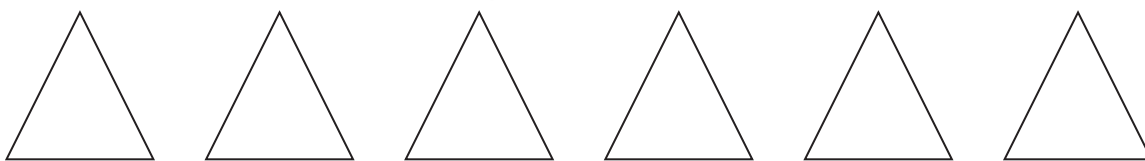
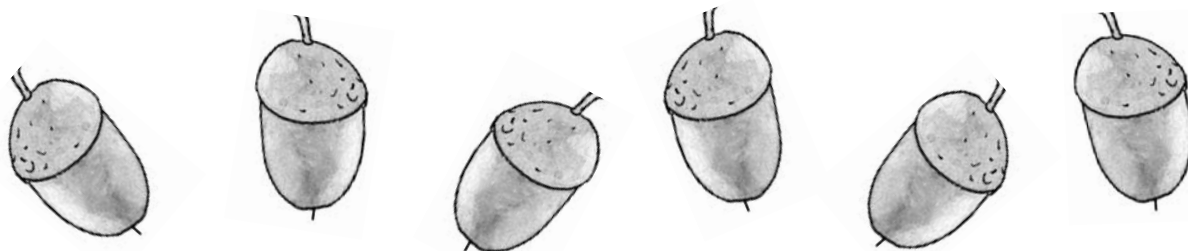

VÄRVI NII+SAMA PALJU KOLM+NURKI, KUI ON ESEMEID.

VÄRVI NII+SAMA PALJU KUJUNDEID, KUI ON PILDIL.

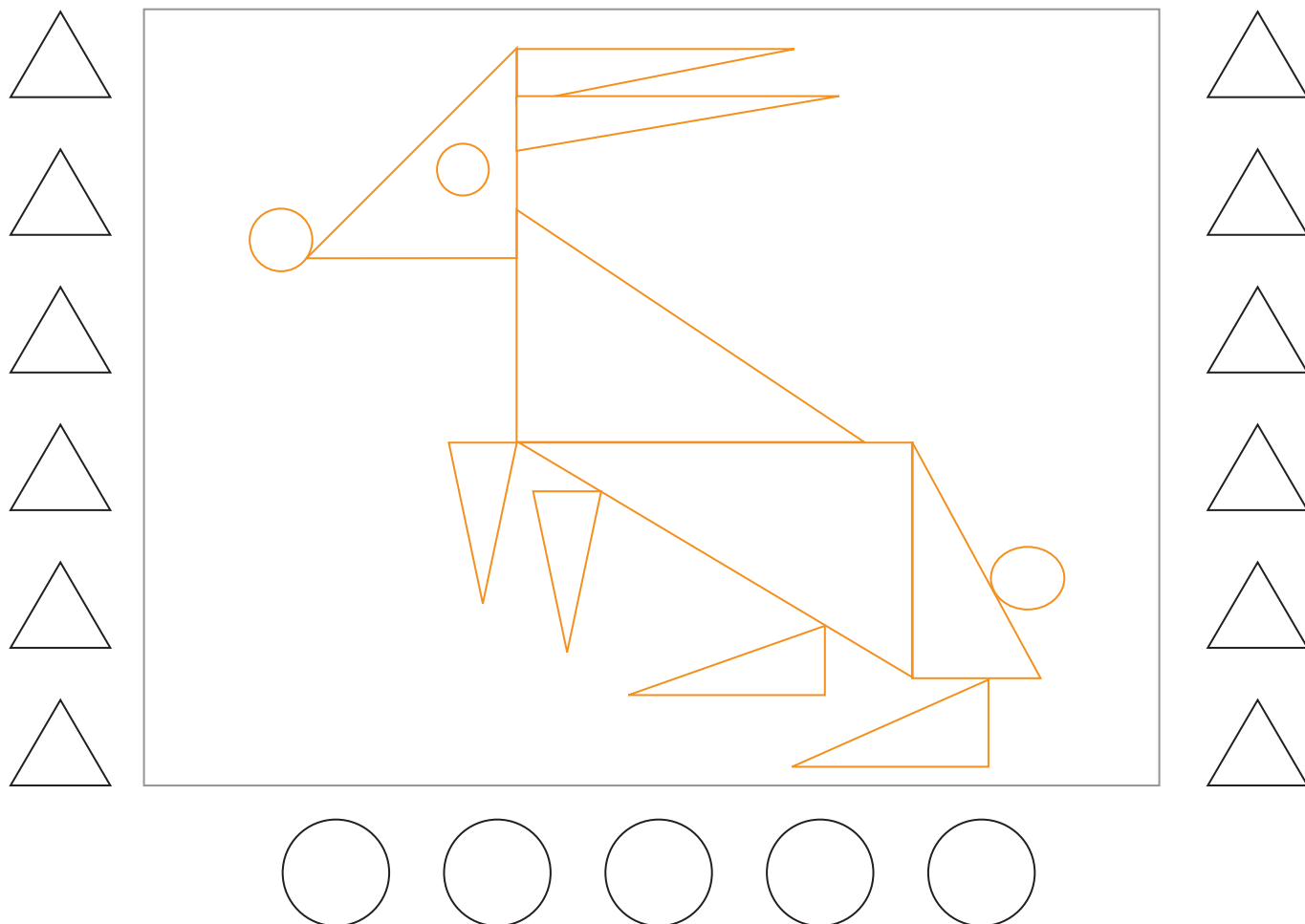

PIIRA JOONEGA SARNASED KUJUNDID. **VÄRVI.**

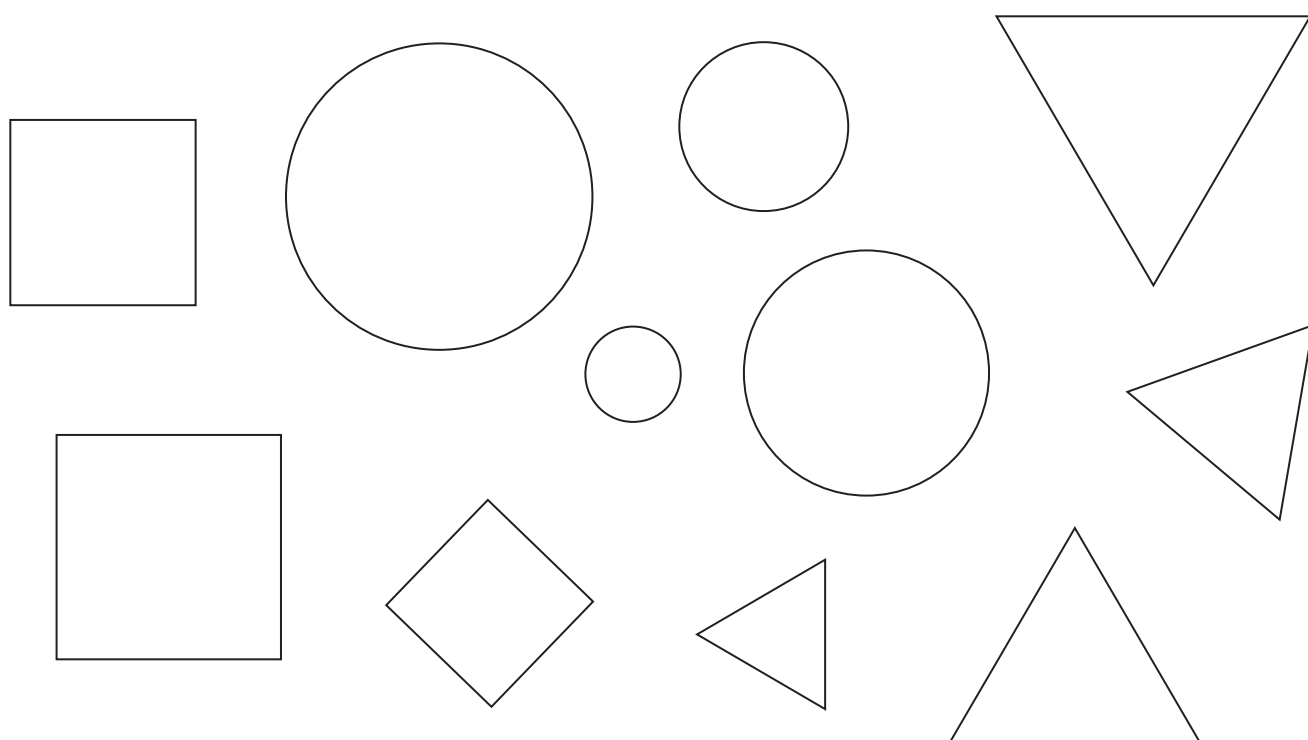

ÜHENDA JOONEGA RINGI+KUJULINE JA RUUDU+KUJULINE KELL.



VÖRDLE.

RINGI+KUJULISI KELLI ON KUI
RUUDU+KUJULISI KELLI.

ROHKEM
VÄHEM

VÄRVI.

RINGI+KUJULINE KELL ON PUNANE.
RUUDU+KUJULINE KELL ON KOLLANE.

VÖRDLE.

KOLLASEID KELLI ON KUI
PUNASEID KELLI.

ROHKEM
VÄHEM

ÜHENDA JOONEGA RING JA KOLM+NURK.

VÄRVI NEED, MIDA ON ROHKEM.

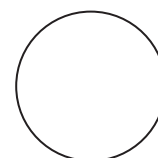
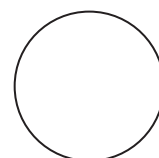
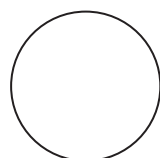
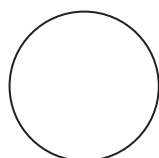
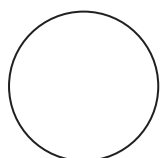

JOONISTA JUURDE NII+PALJU KOLM+NURKI, ET KUJUNDEID OLEKS
VÖRDSELT.

ÜHENDA JOONEGA RINGI+KUJULINE JA KOLM+NURGA+KUJULINE MÄRK.



VÖRDLE.

RINGI+KUJULISI MÄRKE ON KUI
KOLM+NURGA+KUJULISI MÄRKE.

NII+SAMA PALJU
ROHKEM
VÄHEM

ÜHENDA JOONEGA RINGI+KUJULINE JA RUUDU+KUJULINE KÜPSIS.



VÄRVI.

RINGI+KUJULISED KÜPSISED ON PRUUNID.
RUUDU+KUJULISED KÜPSISED ON KOLLASED.

VÖRDLE.

KOLLASEID KÜPSISEID ON KUI
PRUUNE KÜPSISEID.

NII+SAMA PALJU
ROHKEM
VÄHEM

VÄRVI NII+PALJU KUJUNDEID, KUI ON PILDIL.

○ ○ ○ ○ ○ ○

□ □ □ □ □ □ □

△ △ △ △ △ △ △

VÖRDLE.

RINGE ON KUI RUUTE.

RINGE ON KUI KOLM+NURKI.

KOLM+NURKI ON KUI RUUTE.

NII+SAMA PALJU

ROHKEM

VÄHEM

JOONISTA MASKIDELE NÄOD.

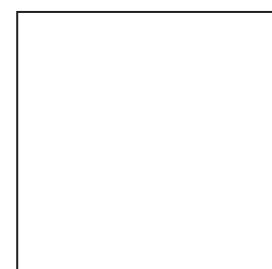
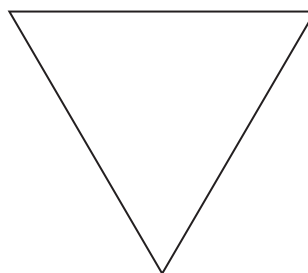
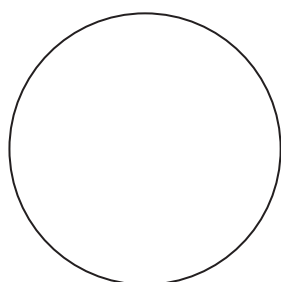
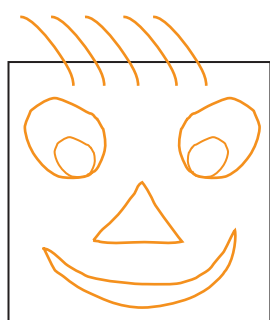

VÄRVI NII+PALJU KUJUNDEID, KUI ON PILDIL.

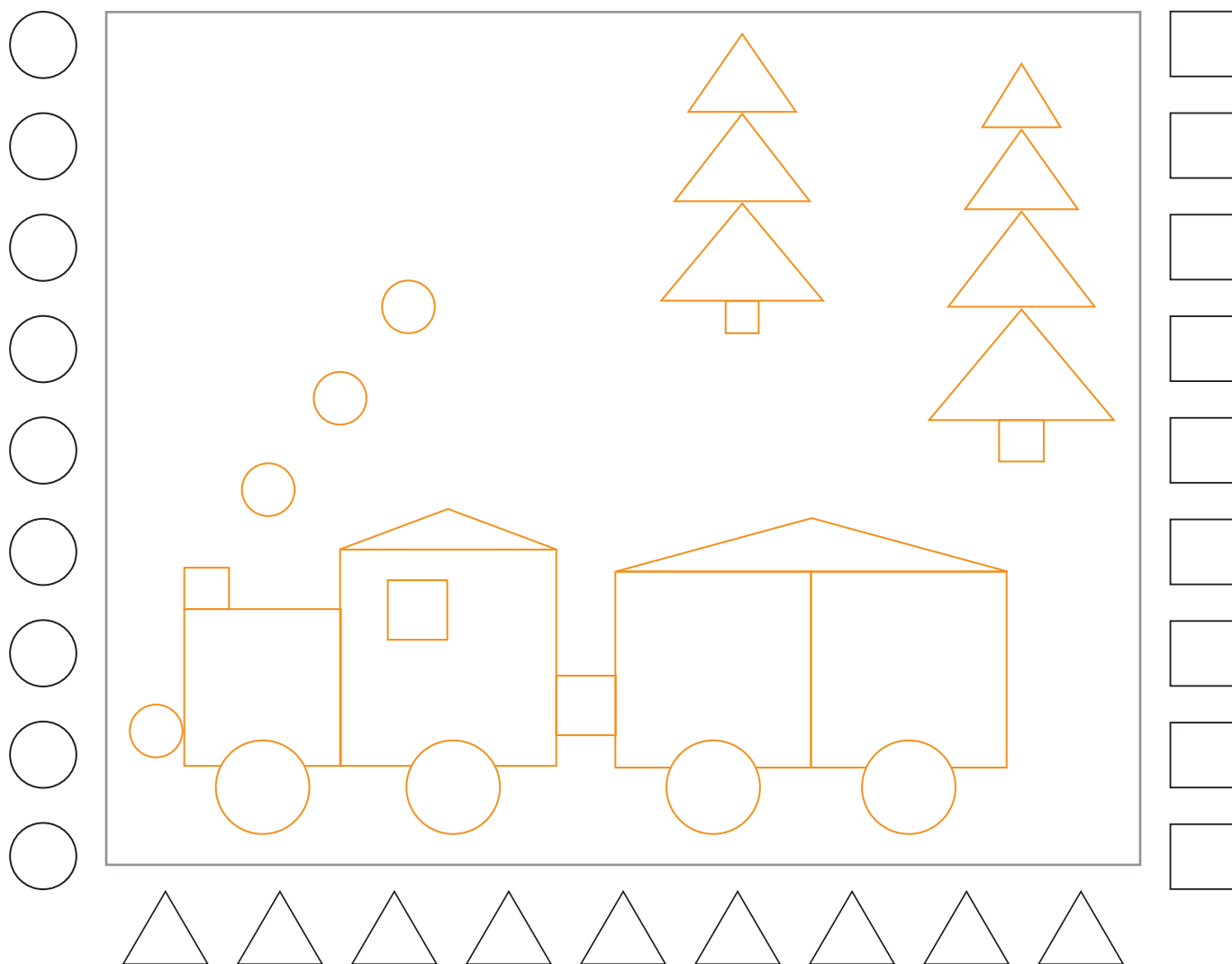

VÖRDLE.

RINGE ON KUI RUUTE.

RINGE ON KUI KOLM+NURKI.

KOLM+NURKI ON KUI RUUTE.

VÄHEM

ROHKEM

NII+SAMA PALJU

JOONISTA MÕNED KOLM+NURGAD JUURDE.

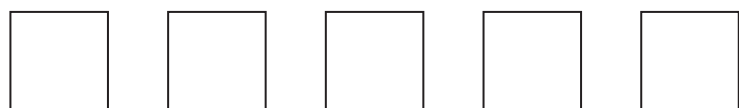

VÄRVI NEED, MIDA ON ROHKEM.

JÄTKA RIDA.

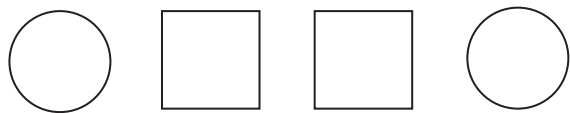

VÄRVI.



KOLLANE



PUNANE



SININE



PRUUN

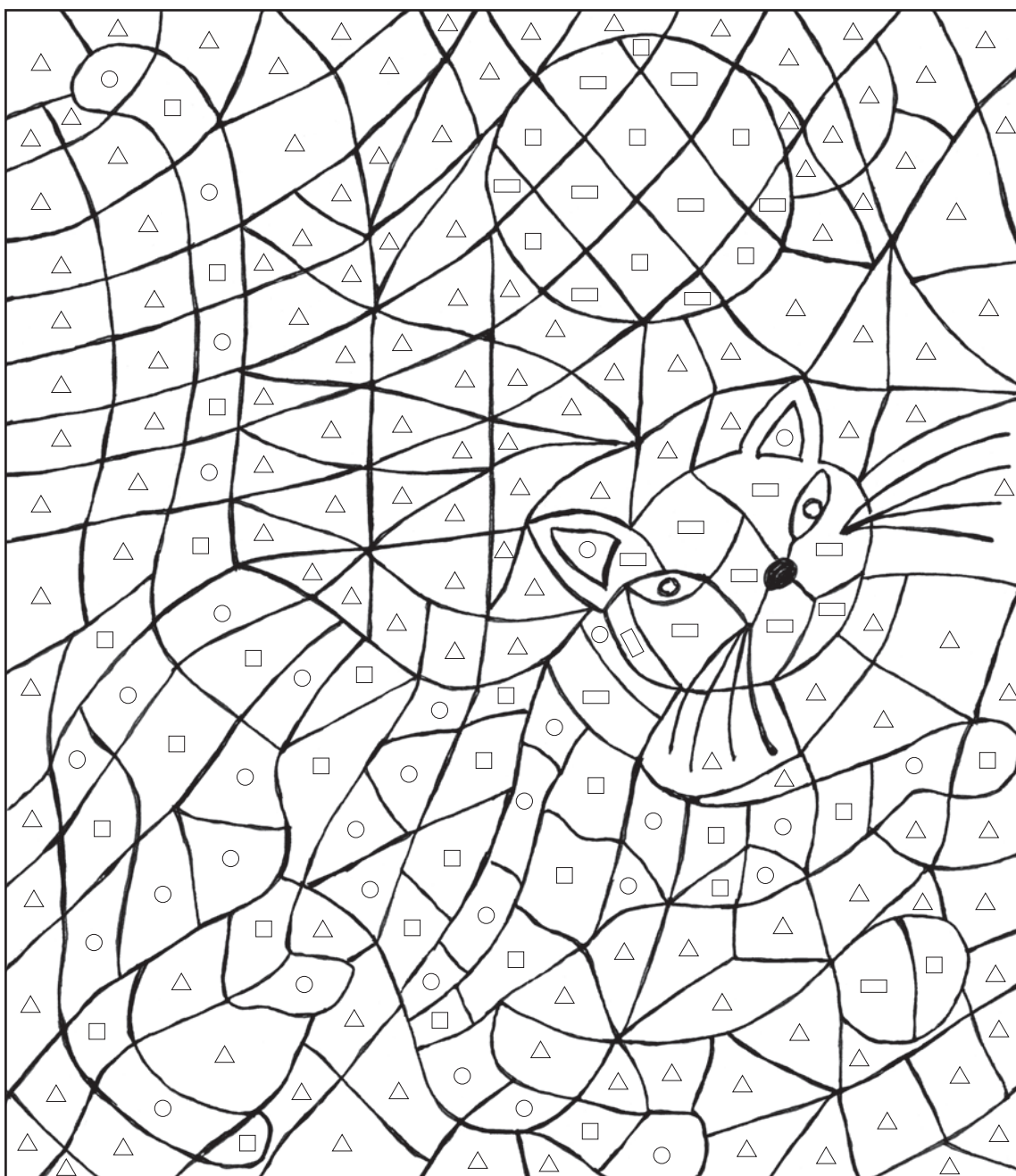

ÜKS – PALJU



ÜKS

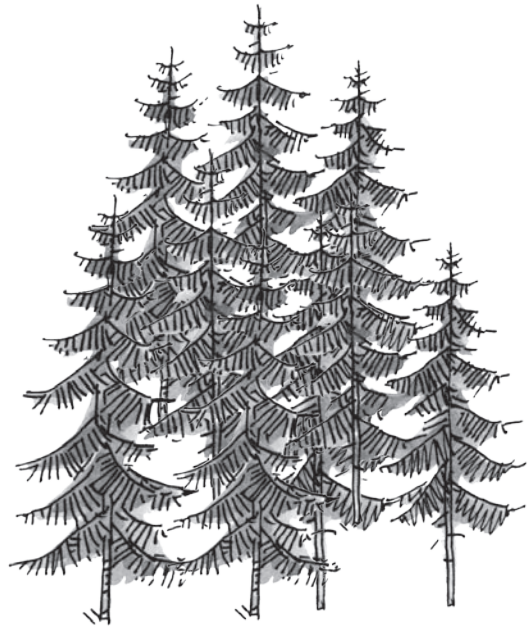

PALJU

VÄRVI NEED, MIDA ON PALJU.

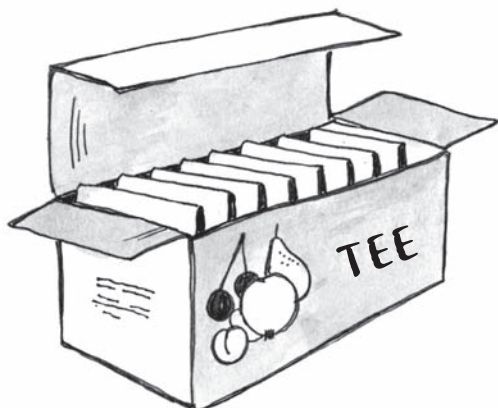

VÄRVI SEE, MIDA ON ÜKS.

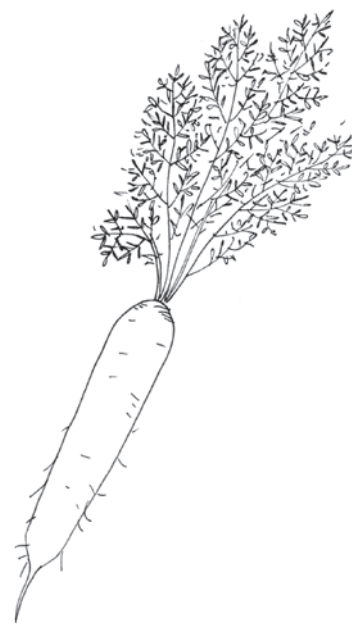
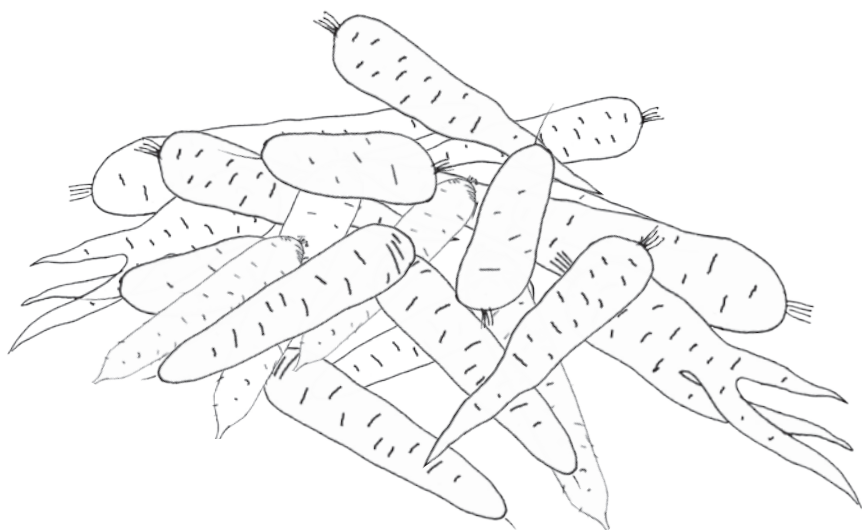

RÄÄGI.

VASAKUL ON PORGANDEID.

PAREMAL ON PORGAND.

ÜKS

PALJU

VÄRVI.

SININE VAAS ON PAREMAL.

ROHELINE VAAS ON VASAKUL.



RÄÄGI.

SINISES VAASIS ON LILL.

ROHELISES VAASIS ON LILLI.

ÜKS

PALJU

VÄRVI SEE, MIDA ON ÜKS.

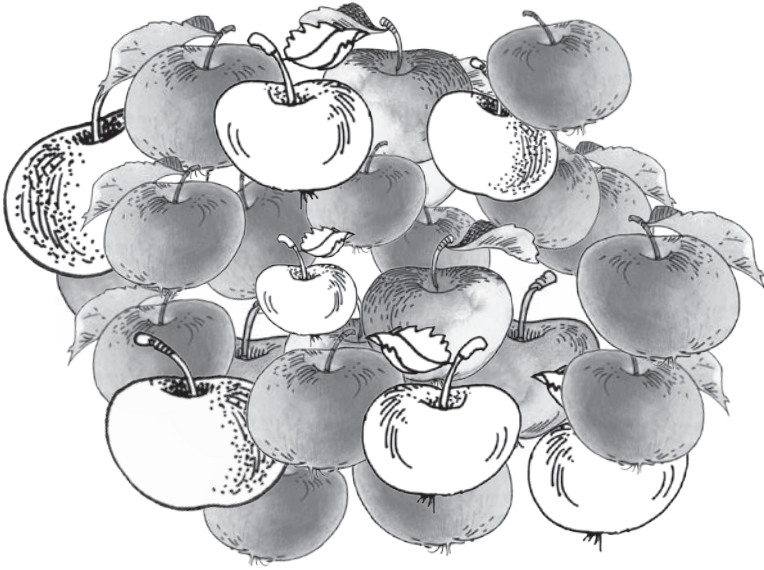

RÄÄGI.

..... ÕUNU.
..... KORV.

ÜKS
PALJU

VÄRVI NEED, MIDA ON PALJU.

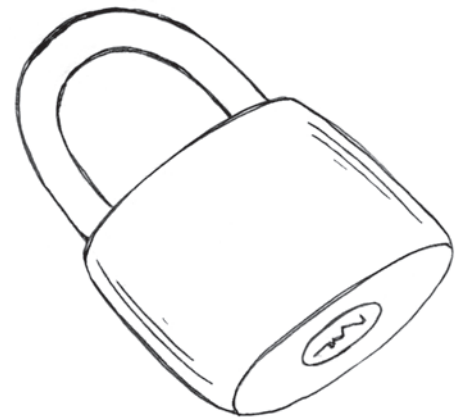
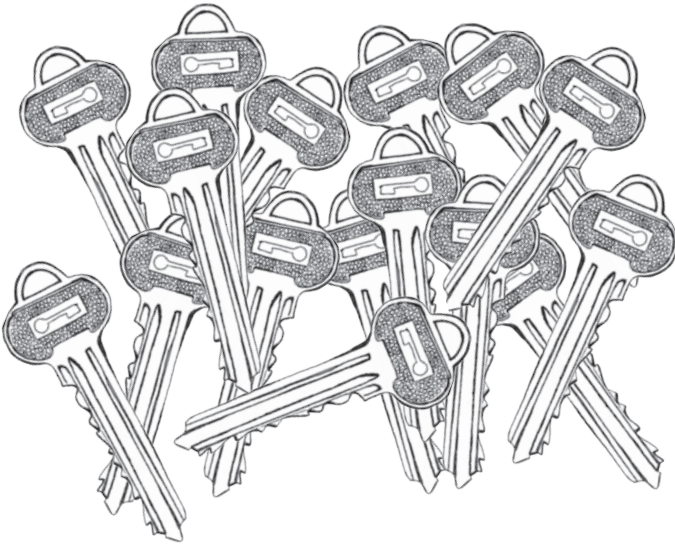

RÄÄGI.

PALJU
ÜKS

LUKK
VÕTMEID

VÄRVI SEE, MIDA ON ÜKS.

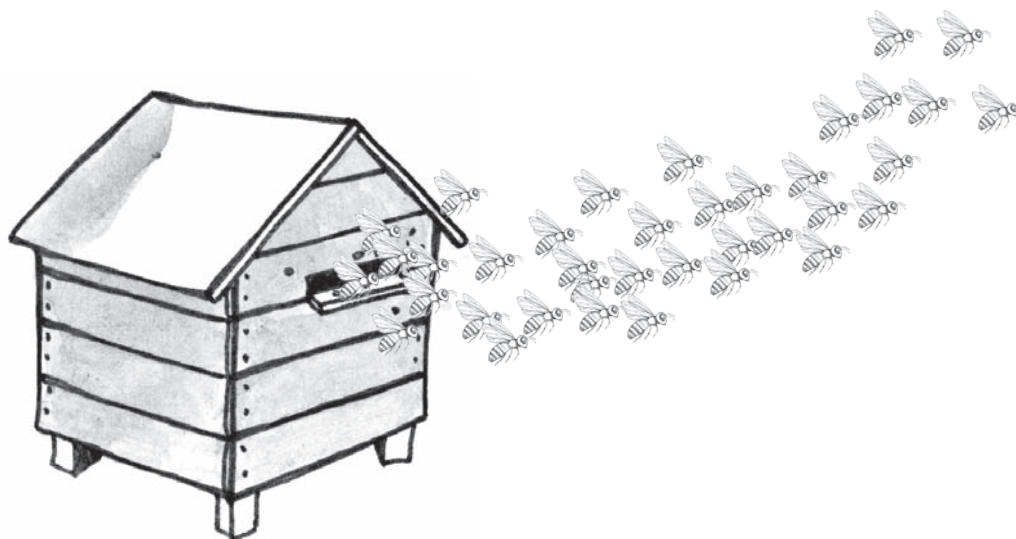

RÄÄGI.

..... MESILASI.

..... TARU.

ÜKS

PALJU

VÄRVI NEED, MIDA ON PALJU.



RÄÄGI.

ÜKS

PALJU

RAAMATUID

RIIUL

SISUKORD

SUUR – VÄIKE	3	ÜLEVAL – ALL, ÜLES – ALLA	40
SUUREM – VÄIKSEM	7	ÜLEMINE – ALUMINE	44
ÜHESUURUSED	11	EES – TAGA	46
PIKK – LÜHIKE	13	EES – TAGA, ETTE – TAHA	48
PIKEM – LÜHEM	16	LÄHEDAL – KAUGEL	50
ÜHEPIKKUSED	20	LÄHEMAL – KAUGEMAL	52
LAI – KITSAS	21	VASAK – PAREM	53
LAIEM – KITSAM	23	PAREMAL – VASAKUL	55
ÜHELAIUSED	26	SIIN – SEAL	58
KÕRGE – MADAL	27	KESKEL – VAHEL	60
KÕRGEM – MADALAM	29	KÕRVAL – JUURES	62
ÜHEKÕRGUSED	31	KÕRVAL – KESKEL – VAHEL	64
KÕRGEMAL – MADALAMAL	32	PEAL – SEES	65
PAKS – ÕHUKE	34	NOOR – VANA, NOOREM – VANEM	68
PAKSEM – ÕHEM	35	HOMMIK – LÕUNA – ÕHTU – ÖÖ	70
JÄME – PEENIKE	36	HULK	72
JÄMEDAM – PEENEM	37	RING	88
SÜGAV – MADAL	38	RUUT	93
SÜGAVAMAL – MADALAMAL	39	KOLMNURK	98
		ÜKS – PALJU	108



Euroopa Liit
Euroopa Sotsiaalfond



Eesti tuleviku heaks



Hariduslike erivajadustega
õpilaste õppevara arendamine

ISBN 978-9949-513-69-7

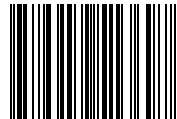

9 789949 513697