

Eleringi toimetised
nr 1/2014 (6)

elering
GENERATING OPPORTUNITIES

TALLINN UNIVERSITY OF
TECHNOLOGY

 Ea Energy Analyses

ESTONIAN LONG-TERM POWER SCENARIOS

Eesti pikaajalised
elektritootmisstsenaariumid

Tallinn 2014

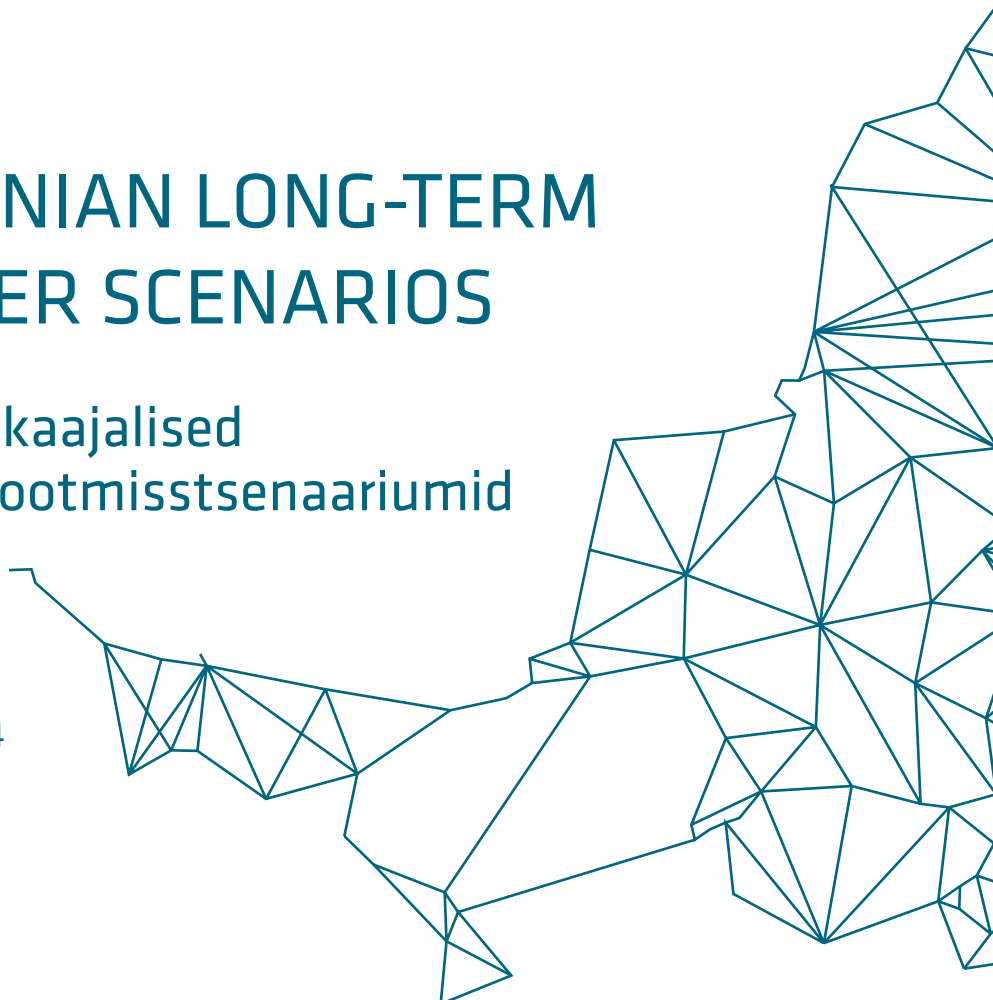

ESTONIAN LONG-TERM POWER SCENARIOS

Eesti pikaajalised
elektritootmisstsenaariumid

Tallinn 2014

Transmission System Operator Elering manages the Estonian electricity system in real time. Elering is responsible for the system's operation and ensures the supply of high-quality electricity to consumers at all times. We create the conditions needed for the electricity market to function and we build cross-border electricity interconnections so that electricity can move freely between neighbouring systems and markets.

Eestikeelne kokkuvõte. Põhijäreldused

- Modelleeritud stsenaariumid kinnitavad, et elektrimajanduses eesmärgiks seatud 17,4% taastuvelektri osakaal kogutarbimisest 2020. aastaks, saavutamaks Eestile Euroopa Liidu energia- ja kliimapolitika raames seatud sihttaseme, on saavutatav turupõhiselt, ilma uute subsidiumideta. 2030. aastaks kujuneb vastavaks tasemeks turupõhiselt ligi 30%.
- Kodumaiste tootmisvõimsuste ja ülekandevõimsuste koosmõjus on Eesti tarbijate varustuskindlus pikaajaliselt tagatud. 110% kodumaise tootmisvõimsuse säilitamine peale 2024. aastat lisab iga tarbitava megavatt-tunni hinnale 6 eurot.
- Tulenevalt naftahindade prognoosidest ning keskkonnapoliitikast, on põlevkivi kasulikum tulevikus kasutada õlitootmises ning vähendada otsepõletust elektritootmises. Põlevkivil on õlitootmises kõrgem väärtus ning elektritootmine ei suuda turu tingimustes põlevkivi ressursi kätte saamisel konkureerida.
- Õlitootmise kõrvalprodukt, uttegaas, on potentsiaalselt hea ressurss konkurentsivõimeliseks elektritootmiseks regionaalsel elektriturul.
- Põlevkivi kasutamise vähenemine elektritootmises tähendab ühtlasi Eesti CO₂ emissioonide olulist alanemist.
- Olemasolevaid keevkihttehnoloogial põlevkivielektrijaamu on võimalik kasutada elektri tootmiseks kivisöest või biomassist.
- Regionaalsel elektriturul on Eesti energiapolitiilistel otsustel elektrihinnale väga väike mõju. Eesti elektrisüsteem on juba praegu tugevalt ühendatud Põhjamaade elektrituruga ja tulevikus integreeritud Euroopa ühtse energiaturuga, kus Eesti osakaal ja sellest tulenev mõju hinnale on väike.
- Eesti 2020. aasta taastuvenergia eesmärgid saab kõige kuluefektiivsemalt täita olemasolevate tuulikutega (umbes 300 MW) ja olemasolevate ning uute biomassi koostootmisjaamadega (kokku umbes 200 MW).
- Analüüsi eelduste tingimustes muutuvad tuuleenergia investeeringud Eestis tasuvaks aastaks 2040 (CO₂ hind 35 eurot tonni kohta). Lähedal tasuvusele on tuuleenergia juba alates 2020. aastatest, kui hind ulatub prognoosi kohaselt 15 euronit tonni kohta. CO₂ kvootide hinnatõus on oluline motiveerimaks investeeringuid taastuvenergiasse.
- Eestis on arvestatav biomassi ressurss, aastaseks metsatööstuse jääkide energeetiliseks ressurssiks on hinnanguliselt 12 TWh primaarenergiat.
- Elektritootmise subsidiumid on vajalikud ainult selliste stsenaariumite korral, kus kogu Eesti elektritarbimine kaetakse omamaise taastuvenergiaga või kus tarbimise katmisel ei arvestata impordi võimalusega.
- Eestis on kasutamata potentsiaal suurendada koostootmisjaamadest toodetud soojuse osakaalu kaugküttes praegusel 40%-lt üle 60%.
- Uute elektrijaamade tootmise omahind on oluliselt kõrgem praegustest elektrituruhindadest. Uue koostootmisjaama elektri omahind jääb vahemikku 50-70 €/MWh ja kondensatsioonielektrijaama puhul vahemikku 70-100 €/MWh.
- Tootmistehnoloogiate omahindadest lähtuvalt kujuneb kogu perioodi keskmiseks elektri hulgihinnaks 65-75 €/MWh kohta. Analüüs viitab tulevikus energiakulude osakaalu vähenemisele Eesti leibkonna eelarves. Energiakulude kasv jääb hinnanguliselt väiksemaks kui Eesti majanduskasvust tingitud elatustaseme tõus.
- Eesti majanduse naaberriikidest oluliselt kõrgem energiamahukus viitab suurele potentsiaalile energiat efektiivsemalt kasutada. Suuremad probleemid on hoonete soojusenergia kasutus ja elektritootmise madal kasutegur.
- Eesti elektriühendused välisriikidega on praeguste plaanide realiseerumisel piisavad kuni 2035. aastani. Edasi muutub sõltuvalt stsenaariumist atraktiivseks lisavõimsuste rajamine Eesti ja Soome vahele.

CONTENTS

	Preface	5
1	Executive summary	6
2	Estonian energy landscape	12
3	The regional perspective	18
4	Methodology and scenarios	22
5	Scenario results	30
5.1	Results – model area.....	30
5.2	Results – Estonia.....	33
5.3	Economic results.....	39
5.4	Sensitivity analysis.....	43
	Glossary	46
	References	48
	Appendix A: Long-term energy scenarios for Estonia – Summary of results	50
	The scenarios.....	50
	The results.....	52

Preface

This study forms a part of the work on the renewal of the Estonian long-term energy strategy (ENMAK). The new energy strategy will focus on the period until 2030, with vision for 2050.

The aim of the study has been to identify the best development path for the Estonian electricity and combined heat and power (CHP) sector. It was also directed to measure the impact of different choices in the energy sector, in Estonia and regionally. The best development path will comply with security of supply, economic as well as environmental goals. Several specific challenges and opportunities for Estonia were analysed, while having the wider EU energy and climate policy in mind.

This study is the second step of the scenario analysis looking into electricity and CHP sector development paths for Estonia and the Baltic Sea region. The first step was executed by Danish consultant company Ea Energy Analyses during the first half of 2013. The first step functioned as the foundation for this study, having larger number and broader scenarios. In the second step, the scenarios are limited and the relevant assumptions are updated according to the latest knowledge. This report gives the results for the national scenarios from the second step. Furthermore, summary of the first step can be found from the Appendix A of this report and the main conclusions are featured in the Executive summary.

The study is a collaboration of Elering, Ea Energy Analyses and Tallinn University of Technology. The steering committee for the study consisted of representatives from Ministry of the Economic Affairs and Communications, Ministry of the Environment, Enterprise Estonia, and Estonian Development Fund.

The scenarios presented in this report focus on the primary result of different development paths for the energy sector towards 2050. This includes operation of the energy system, investments in new generation, price developments, socio-economic welfare changes and CO₂ emissions. The results will be used in a subsequent project where a strategic environmental impact analysis will be performed including assessment of job creation, health issues and other relevant impacts.

1 Executive summary

In the long perspective, i.e. since the first oil crisis in 1973, many European countries have had stable and continuous energy policies. The policies have been guided by goals of security of supply, environment and economy. The last 15 years the EU has supported this development with European-wide initiatives, like minimum fuel taxes, CO₂ emission quotas and minimum energy efficiency requirements. This is expected to continue in the future, e.g. towards 2030 and 2050.

On the way, crises and surprises will occur. The current collapse of the EU ETS CO₂ quota price can be seen as such a surprise. Fuel prices may fluctuate and policy focus may vary. Security of supply, environmental protection or economy may be high or low on the agenda. However, in the long run an active energy policy can be expected to be relevant and important.

The EU has a clear framework to steer its energy and climate policies up to 2020. This framework integrates different policy objectives such as reducing greenhouse gas (GHG) emissions, securing energy supply and supporting growth, competitiveness and jobs through a high technology, cost effective and resource efficient approach. These policy objectives are delivered by three headline targets for GHG emission reductions, renewable energy and energy savings (European Commission, 2013a).

Estonia

Estonia has relatively high primary energy intensity in spite of a moderate industrial sector. A relatively low share of combined heat and power (CHP) in the district heating systems and relatively inefficient oil shale power plants contribute to the high energy intensity. From 2001 to 2011 the intensity measured in final energy has decreased: with an average economic growth above 3%, the growth in final energy consumption has only been 0,5% p.a. The average energy demand for heating is relatively high¹: 280 kWh/m², and the process of realising energy improvements in existing buildings can be slow – but crucial for the long term development of the energy consumption.

Estonia has significant resources of oil shale, biomass and wind. The balanced utilisation of these can – together with increased energy efficiency and use of CHP for district heating – be cornerstones for the Estonian energy strategy.

Scenarios for the future: 2030 and 2050

In this project, a number of different future scenarios are explored. The purpose is not to predict the future, but to focus on a few, selected issues, and understand their consequences. When selecting the setup of the scenarios for this study, mainly the national issues are focused on. As an input to the Estonian Energy Strategy, mainly the levers in disposal of the Estonian decision-makers are analysed. However, some conclusions are given also from the preceding study by Ea Energy Analyses (see Appendix A), where scenarios with international perspective have been studied. The international scenarios essentially analyse the impact of different intensity of climate policy through different CO₂ prices.

General focus areas of the study are:

- Security of supply in Estonia
- National policy on renewable energy in Estonia
- The use of oil shale in Estonia
- Global climate change policy and challenges related to carbon leakage to Russia

¹ Delivered heat demand including electricity for heating purposes. This is without conversion factors

In this study, five scenarios are simulated with the BALMOREL model of the district heating and electricity systems. The electricity system interacts across national borders, and is studied for the entire Baltic Sea region: The Baltic States, the Nordic countries, Germany, Poland and North-West Russia.

The five scenarios are:

- Liberal market scenario: Medium fuel and CO₂ prices, corresponding to the IEA's new policy scenario. Oil shale is priced at the substitution price. Perfect electricity market in the entire model area. Investments in generation from 2020 and in transmission from 2026.
- Liberal+ scenario: As the liberal market scenario, but with a specific requirement (N-1-1) to the electricity capacity in Estonia. Some extra local capacity is built for added security of supply.
- Renewable energy (RE) focus scenario: Has a transition to 100% renewable energy for district heating and electricity in Estonia by 2050 with interim goal of 50% by 2030.
- No fossils scenario: Burning of fossil fuels is not allowed in the electricity and district heating generation in Estonia.
- Oil shale BAU scenario: The scenario has a more gradual phase out of electricity generation from oil shale than other scenarios. The shale oil production by-product retort gas is used in electricity generation.

Modelling results

Reduced use of oil shale

Based on the inputs the model finds optimal investments and optimal dispatch of electricity generation in the entire region. A significant result across scenarios is the reduced use of oil shale for Estonian electricity generation. Electricity based on oil shale is – in general – not competitive and the model rebuilds existing plants from oil shale to coal as soon as possible. The reason for this is that the cost of oil shale has been set to the substitution price. This price corresponds to the value of oil shale for producing shale oil. With the relatively high oil price predicted by IEA, oil production is more attractive than using oil shale for electricity generation.

Regionally, there are different views on the use of coal for power production. Several countries in the region have decided not to invest in new coal power capacity (e.g. the Nordic countries). Others have the policy that the weight given to climate change is expressed in the CO₂ price and that a ban on new coal power plants is not relevant.

Renewable energy

The simulations show that the most cost-effective way for Estonia to realise its 2020 renewable energy goal of 17,4% of electricity demand is through about 200 MW_{el} new and existing biomass CHP plants in combination with the existing and planned wind (330 MW) and biogas plants (6 MW_{el}).

In all scenarios the goal can be realised without subsidies. It should be noted, however, that the current low CO₂ price is not sufficient to facilitate this development. A CO₂ price of 15 €/ton in 2020 is assumed in the scenarios, which is higher than present about 6,5 €/ton. The difference can be seen from the CO₂ collapse scenario analysed in the preceding study (see Appendix A). In the CO₂ collapse scenario, cost similar to a subsidy of 9 €/MWh (to all renewable electricity generation) is needed to realise the renewable energy target.

Additional wind power expansion is close to being cost-effective. With a medium CO₂ price it is economically feasible to invest in wind power at sites with good wind resources. Currently the CO₂ price is low and with this price wind cannot compete with e.g. coal power.

In the model all existing subsidies are excluded, however the 2020 targets are set up as a requirement. The understanding is that the current subsidies are meant as a transition, and will not exist in the long run. Technology costs are decreasing while CO₂ prices are increasing and this could make renewable energy profitable. The EU 2020 requirement will drive regional investments in renewable energy for the following years.

The modelling results show, that wind power is economically profitable in Estonia without any subsidy from 2040 and onwards. This is true with assumed CO₂ prices and technology advancements. Results show up to 2 GW of installed wind power in liberal market scenario and up to 3,7 GW in renewable energy focus scenario by 2050.

Estonia has a significant biomass potential. This resource is very attractive as a CHP fuel with the assumed CO₂ prices and the unrealised CHP potential in Estonia. The local resource can be supplemented by import from neighbouring countries. Up to 5 TWh of biomass primary energy is being used in the CHP-s in Estonia, while the Estonian total forestry biomass resource for energy is estimated at 12 TWh. In the no fossils scenario, biomass is also used in the condensing mode, which creates a need for biomass imports.

A strategy for the use of biomass could be considered. In the simulations, biomass consumption will increase at least by a factor of two in Estonia and by a factor of five in the whole region (2020 compared to 2012). Development of sustainable biomass resources from forest and wetlands could increase the role of Estonia as a supplier of biomass to the growing market.

The renewable energy scenario, with the shift to all renewable energy by 2050, costs 48 M€ in net present value (NPV) more for Estonia than the liberal scenario. This is a social welfare loss on the power market, considering the market price effects to the producers as well as to the consumers of heat and power. The renewable energy goal is to the most part achieved by gradual investments in wind power. It is estimated that the scenario requires a total of 70 M€ subsidy in NPV, which corresponds to 0,2 €/MWh on all demand from 2020 to 2050. The mediocre required subsidy can be seen as a sign of wind power being relatively competitive, even before 2040. It indicates that with assumed CO₂ price and technological development, wind power needs little help.

CO₂ emissions

All scenarios show a major reduction in CO₂ emissions in Estonian heat and power sector in the whole period until 2050. Especially steep reduction can be observed from the present to 2020 in all but oil shale BAU scenario. This is due to reduced electricity generation from fossil fuels and phasing out oil shale from the electricity production. Oil shale is replaced by coal or biomass, however, to a smaller extent. The emission reductions after 2020 are led by reduction in the use of coal.

From the five scenarios in this study, the emissions are smallest in the no fossils scenario, while they are largest in the oil shale BAU scenario. In the oil shale BAU scenario, using oil shale and retort gas as fuels for electricity production is keeping the emissions up. It must be noted that while not using oil shale in heat and power sector reduces the emissions in that particular sector, it increases the emissions from the oil production. Therefore, the total Estonian CO₂ emissions may reduce in a lot slower pace.

The preceding study by Ea Energy Analyses has also analysed the impact of different CO₂ prices. A very high CO₂ price (73€/tonne in 2030 and 100€/tonne in 2050) will accelerate the phase out of fossil fuels and keep the modelled region in line with the ambitious goals of EU Energy Roadmap for 2050. At the same time, a collapse of the CO₂ price system has the effect of considerably slowing down the reductions in emissions, to the level of efficiency improvements in the power plants².

Discussion

EU energy and climate regulation is likely to remain an important driver for the future Estonian energy policy. In January 2014, EU Commission suggested new binding 2030 goals for CO₂ and renewable energy (European Commission, 2014). These goals on EU level are 40% CO₂ emissions reduction and 27% renewable energy target. An important starting point when framing a new Estonian energy strategy should therefore be to position itself in the EU framework for 2030. Although many aspects are the responsibility of market actors, an active energy policy is still relevant to support the desired development path. While the country specific goals are not clear yet, the modelled scenarios suggest that Estonia is able to comply with the EU goals.

Oil Shale for electricity or fuel

Estonia has unusually high primary energy intensity per GDP: 50% higher than Latvia and Lithuania and six times higher than Denmark (see chapter 2). The relatively low efficiency of oil shale power plants is part of the explanation. The study indicates that the traditional way of using oil shale for electricity generation is not competitive. It is more profitable to rebuild the three newest oil shale plants to coal or biomass. In most of the scenarios analysed, very little oil shale is used for electricity production beyond 2022. Instead, shale oil is produced from the resource.

2 For modelling results for CO₂ price scenarios, see Appendix A

CHP

Having access to a district heating network with a heat demand is a strong starting point for producing electricity. The levelised cost of energy (LCOE) produced from new combined heat and power (CHP) plants is in the range of 50-70 €/MWh compared to electricity only generation with typical prices of 70 – 100 €/MWh (see chapter 4 for LCOE estimations).

Around 40% of the current district heating demand in Estonia is supplied by CHP. The European average is 60%, and in Denmark the figure is 71%³. This indicates an unutilised potential for CHP in Estonia. The BALMOREL model analyses show that it is profitable to increase the share of CHP to around 60%. This is a result of building new CHP units as well as the expected reduction in heat demand. Notably, the simulations indicate, that biomass based CHP is economically attractive even in small to medium sized district heating networks. District heating can help make the system more flexible, since a fuel shift is cheaper to implement in a central system. Due to expected reduction in the total heating demand in Estonia, it could be relevant to study in more detail the potentials and barriers for further expanding the district heating supply, and the possibilities for increasing the CHP share in districts heating system.

The use of heat storages can increase value of generated electricity – with increased electricity generation capacity, electricity can be produced during the hours with the highest electricity price. Heat storages can also reduce the need for peak load boiler generation in district heating systems, thereby reducing fuel costs significantly. The simulations show that investments in heat storage are attractive in all scenarios indicating that this choice is robust.

Energy efficiency

Probably the best no regret option for any country is to increase the energy efficiency. It is well-known that a potential for profitable energy efficiency projects exists. Realising this economic potential is attractive in most future development scenarios. In long-term scenarios with high fuel or CO₂ prices, it may even be relevant to go beyond what seems attractive today.

With the new EU energy efficiency directive from 2012, Estonia is obliged to analyse the instruments used to promote energy efficiency. One possible option is to introduce energy efficiency obligations to energy companies – a set-up that has been successful in Denmark⁴.

Buildings in Estonia have a relatively high energy demand for heating, approx. 280 kWh/m²⁵, indicating that there is a significant potential for reducing the demand. At the same time a very large share of the demand for heating in detached house is provided by fire-wood. The scenarios foresee a reduction in the demand for heating as well as a gradual substitution of firewood by modern heating technologies like electric heat pumps and district heating. Though using fire-wood is a renewable energy source, it is rather labour intensive and the efficiency of the stoves is rather low. Moreover, from an energy system perspective it is not suitable to use biomass, which is likely to become a more scarce resource in future, for low temperature heating.

Security of supply

It can be relevant to modernise the 110% rule for Estonian inland generation capacity which is imposed to secure security of supply. An improved rule could focus on reliability. This term includes both adequacy (to have the capacity to cover demand all year round) and security of supply (the ability to withstand sudden disturbances in the system). Studies of reliability can point to the need of more generation capacity as well as other steps, e.g. improved protection equipment, increased transmission capacity or introduction of demand response. Reliability studies typically include all hours of the year and have a probabilistic approach, allowing imports and wind power to contribute to the security of supply.

In the preceding study by Ea Energy Analyses, the impact of the 110% capacity rule was analysed. Comparing the 110% and the liberal scenarios it is possible to assess the consequences of having a 110% rule in Estonia. The 110% rule secures that there will always be local capacity to cover the peak electricity demand in Estonia. Wind, solar and transmission lines are ignored in the calculation of local capacity. The simulations show that there is sufficient capacity (existing and planned) until 2024, but after this year extra investment must take place in Estonia to meet the 110% requirement. For Estonia the total cost of the rule is 227 M€ (NPV). For generators the loss is 566 M€. The Estonian cost of the 110% rule corresponds to 6 €/MWh of all electricity used between 2024 and 2050 in net present value.⁶

3 See: www.cospp.com/articles/print/volume-10/issue-4/features/district-heating-in-germany-a-market-renaissance.html

4 See: European Commission (2012): Energy efficiency directive. For evaluation of the Danish obligation scheme see: Bundgaard et al. (2013 a and b)

5 Delivered heat demand including electricity for heating purposes. This is without conversion factors

6 See Appendix A for results of the 110% security of supply scenario

International competitiveness of generators

The international competitiveness of electricity generators has been analysed looking at the export balance of electricity, net profit and operational hours. The general result is that Estonia tends to have a negative export balance if retort gas is not used for electricity production or if renewable energy does not get additional attention (RE scenario). With regards to the CO₂ prices, lower prices tend to favour Estonian generation more than higher prices. This is caused by the high carbon intensity of the Estonian electricity sector, which presently ranks one of the highest in the EU by CO₂ emissions per unit of electricity. Further, finding a solution for the carbon leakage issue with the third countries is an important point for Estonian, as well as for other Baltic States' generators⁷.

Regarding the profit margins of the generators, it has been observed that there is a positive profit margin for all electricity and CHP generators. The estimated new CHP and wind capacities are performing well economically in the climate of rising CO₂ prices and electricity demand. However, the electricity wholesale prices must rise to the level of 65-70 €/MWh in order to support the new investments. This is readily achievable on the market, as with lower surplus capacities, the market prices will increase. Still, the relative tightness of capacity will also induce short periods of very high prices, which can be inconvenient for the market participants.

Infrastructure upgrades

The development of onshore wind power is generally high in all scenarios, when coming closer to 2050. Especially the very high levels of wind power will lead to an increased need for grid upgrades, which will lead to higher costs to enable the transport of wind power from e.g. the coastal regions with good wind resources to the transmission grid. The deep connection costs are the costs related to upgrades of the existing grid if this is necessary, which are not included in this study. The ENTSO-E EWIS study concludes that the operational costs associated with wind integration are 2,1 €/MWh of wind energy in their best estimate scenario.

Consumer affordability

The typical wholesale costs of electricity are 65-75 €/MWh in the scenarios. The wholesale price is found as the marginal price for generating electricity. For the end-user grid tariffs and taxes should be added to find the total costs. The subsidies needed in some of the scenarios could be collected with a tariff. In this case this value must be added to the wholesale price.

It should be noted that the wholesale electricity prices in the scenarios are significantly higher than the current market price on Nord Pool Spot. Compared to this current average electricity market price of around 45 €/MWh, the price in the scenarios is expected to increase by more than 30%. This is a significant increase, which is needed to support the new investments to generation capacities.

Infrastructure costs are also expected to change and increase for some elements, e.g. wind power grid integration costs. This can result in increased tariffs and, therefore, consumer prices. However, the cost of energy is calculated to increase at a slower pace than the economic growth, during the period. This implies that for Estonia the share of energy cost in the household budget should be decreasing.

⁷ See Appendix A for scenarios of different CO₂ prices and carbon leakage with third countries

2 Estonian energy landscape

The development in the Estonian energy consumption has been modest the last ten years. Consumption has increased by 7% from 2001 to 2011 (see Figure 1). In the same period the GDP has increased by 48% – illustrating the possibilities of decoupling economic growth and energy consumption. Compared to other countries, the energy consumption of the residential sector makes up a relatively high share of the final energy consumption in Estonia.

Figure 1:
Development in final
energy consumption in
Estonia (Eurostat, 2013)

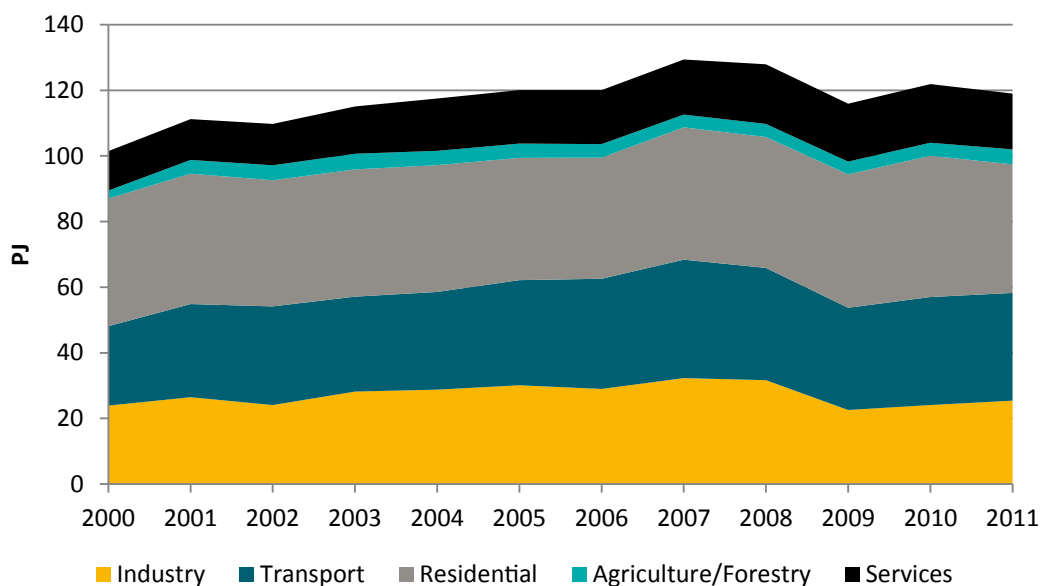

Comparing Estonia to neighbouring countries reveals some important differences (Figure 2 and Figure 3). Figure 2 shows that there appears to be a strong tendency towards a lower energy intensity as the economy grows. Estonia and Denmark both have relatively little industry – but the energy intensity (final energy per € of GDP) of Estonia is many times higher. The difference may be due to an autonomous development together with higher wealth (e.g. better comfort and lower energy consumption due to well-insulated houses) and a policy driven improvement in form of strong policy instruments to promote energy efficiency (e.g. high energy taxes, energy efficiency obligations for energy companies, strong building codes, energy audits in industry, etc.).

Figure 2:
Final energy intensity
and GDP per capita 2010
(Eurostat, 2013)

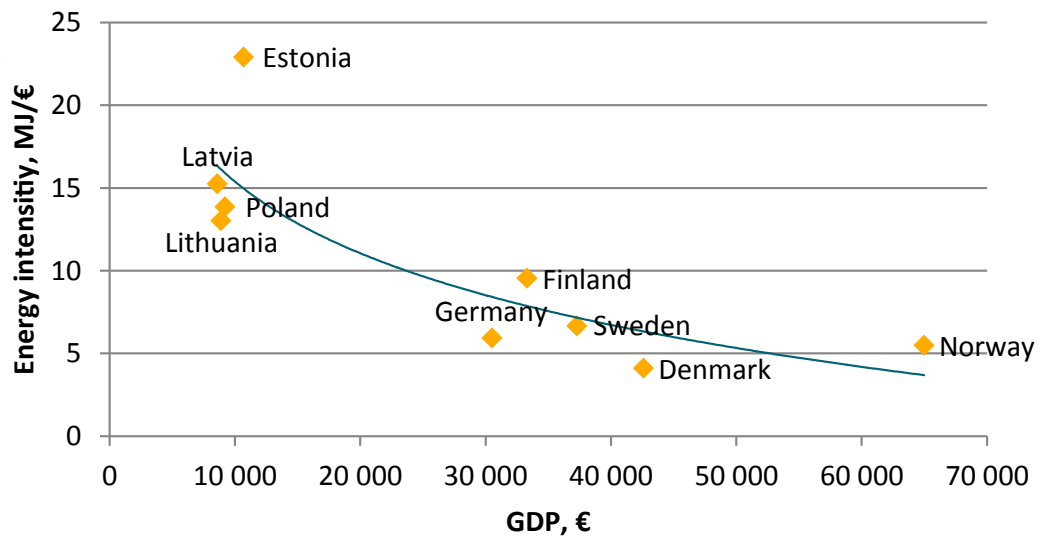

Estonia is a very energy intensive country measured in primary energy per GDP (Figure 3). The relatively high losses in the energy sector can be explained by export of electricity (the fuel is accounted in the primary energy consumption, but exported electricity is only accounted by its energy content), relatively low conversion efficiencies (e.g. 30% on old oil shale plants) and losses in the district heating networks. About 40% of the district heat is generated via combined heat and power (in Denmark this value is 71%).

In 2010 Estonia exported 3,3 TWh of electricity. This export has increased the total primary energy consumption by 10-15%. Export of electricity produced from oil shale supports the current account surplus as well as the GDP, while this outcome could also be achieved by exporting shale oil.

Figure 3:
Energy intensity of
the economy 2010
(Eurostat, 2013a)

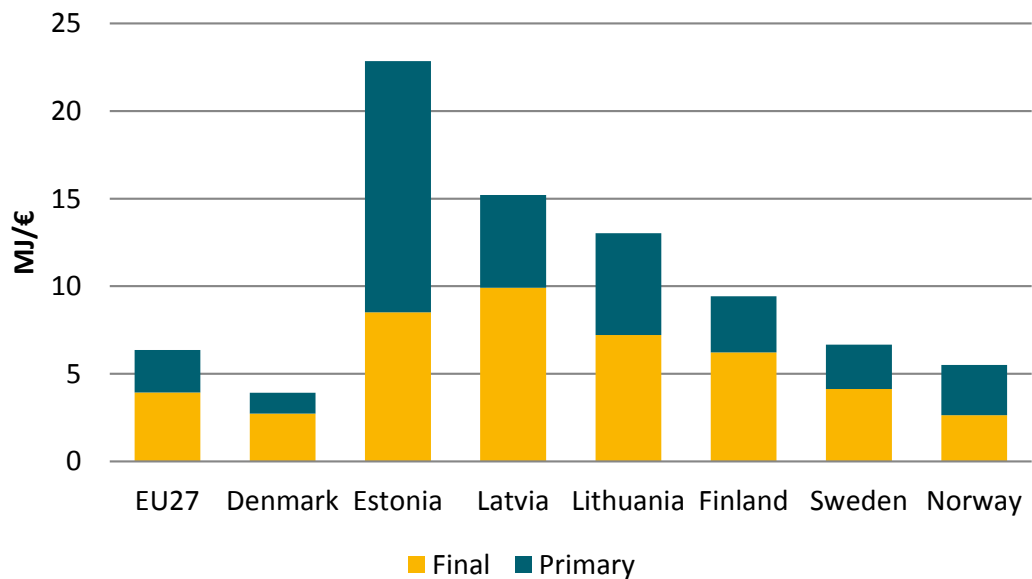

Estonia already has a high share of renewable energy, mainly in the form of wood used for heating. The declared goal is to reach 25% renewable energy in the gross final energy consumption by 2020. Figure 4 illustrates the National Renewable Energy Action Plan for reaching the mentioned goal. The goal is to be reached despite the reduction in heat demand and corresponding reduction in need for biomass for heating. The goal for the share of renewable electricity is set to 17,4% of the electricity demand.

Figure 4:
Expected development in
the share of renewable
energy in Estonia (Ministry
of Economic Affairs and
Communications, 2010)

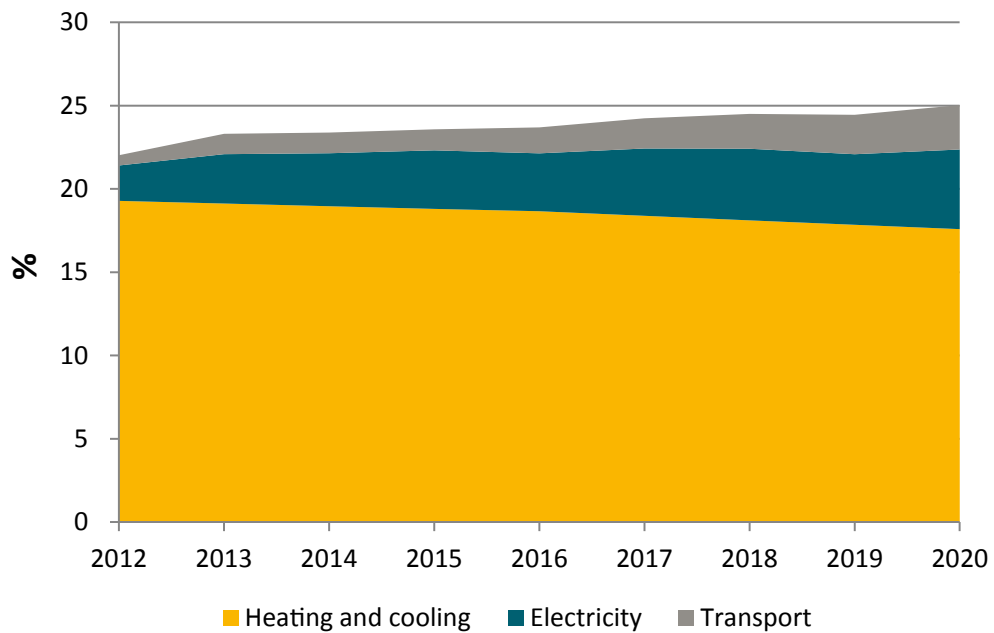

Oil shale

Oil shale is sedimentary rock containing up to 50% organic matter. Once extracted from the ground, the rock can either be used directly as a fuel, for example in a power plant or an industry, or be processed to produce shale oil and other chemicals and materials⁸. Mining started before 1930 and peaked in 1980 at 30 Mton/year.

Estonia has decided that a maximum of 20 Mton (about 24 Mton tradable) oil shale is allowed to be extracted per year (corresponding to approx. 140 PJ after subtraction of mining losses). The resource would at this pace last for about 50 years of mining.

Because of its relatively low energy content, oil shale is typically not transported over long distances, but is instead utilised locally. In Estonia oil shale has been used for electricity generation since 1940. Oil shale based electricity has for many years exceeded local needs and electricity has therefore been exported to neighbouring countries.

Oil shale has also been used to produce shale oil that can be refined to diesel oil. As capacity for producing shale oil becomes available, this use of the oil shale competes with the alternative use in power plants.

Emissions

Oil shale used in a new power plant (circulated fluidized bed boilers) results in CO₂ emissions of 900-1000 g/kWh, which is higher than coal based plants. The relatively low efficiency of the oil shale plants increases the specific emissions.

Older power plants (pulverized combustion boilers) have much higher SO₂, NO_x and fly-ash emissions than newer ones. For example, in new plants SO₂ emissions have been reduced from 2,000 mg/m³ to 0-20 mg/m³.

Biomass resources

	Potential
Wood	49 PJ
Waste	3 PJ
Straw, hay, reed	1 PJ
Biogas	9 PJ
Peat	4 PJ

Estonia has considerable biomass resources and is a net exporter of wood pellets. Table 1 shows the estimated biomass energy potentials for Estonia.

Also neighbouring countries have significant biomass resources. It is therefore possible to import biomass, also in form of wood chips. Import could be used for local consumption or to produce wood pellets for export.

Table 1:
Estonian biomass
potential in 2030
(Estonian Development
Fund, 2013)

Wind resources

Estonia has good potentials for wind power, e.g. offshore and in coastal areas. E.g. BASREC (2012) describes that Estonia has 4 TWh offshore wind power potential in the very high category (indicating the best combination of wind speeds and sea depth). According to (Ea Energy Analyses, 2010), around 900 MW of wind power can be added to the Estonian electricity system in relatively short term and with low levels of curtailment.

Security of supply

It is important for any country to have a high level of security of electricity supply. Many different aspects are covered by the term security of supply, e.g.:

- Having capacity to cover the electricity demand with local generation.
- Low probability of lack of electricity supply (including black-outs and brown-outs). This concerns the overall probability of lacking supply, including the probability of failure in generation and grid, locally and regionally.
- Independence of other countries (e.g. natural gas from Russia or oil from OPEC).

110% rule

In the current Estonian Energy Strategy the 110% rule has been applied to the electricity sector. It has been required that Estonia must always have sufficient inland capacity for electricity generation to cover its yearly peak demand. Intermittent generation like wind and solar are not included in the calculation. With the existing power plants it is expected that the 110% requirement will be fulfilled without any extra investments in new capacity until 2024.

If energy markets were well functioning and energy consumption was truly price sensitive, there would be no need for a requirement for a certain amount of inland electricity generation capacity. Price driven investments, import as well as demand reduction in Estonia and other countries would guarantee that peak demand could always be met (maybe at a high price). However, electricity demand is typically not very flexible, and large parts of the consumption are usually not sensible to high prices (e.g. spot prices above 250 €/MWh). Moreover, Estonia is neighbouring Russia, where market rules are very different from Estonia and the Nordic countries. This makes it relevant to analyse a national scenario with requirements regarding local capacity.⁹

Transmission lines with neighbouring countries are not counted in as security of supply measures under the 110% rule. Today Estonia has transmission lines in the order of 2,500 MW, with Finland, Latvia and Russia. In 2022, the interconnector capacity to all Baltic States together is expected to be 5,250 MW (Elering, 2013b).

With this high degree of interconnections it is clear that the 110% rule is overly simplistic. An improved method of ensuring security of supply should focus on the probability of lack of supply. Such a probabilistic method would cover all year (not only peak hours¹⁰) and would include transmission lines and intermittent generation. The focus of such a method would be the short-term (dynamic) risk of the electricity system.

In general, the interconnected electricity systems have a much higher security of supply than the isolated systems. However, new types of risks exist in an interconnected system – import of blackouts, for example voltage collapse, that occur with only seconds notice and therefore can be difficult to be protected against.

Transmission grid connection

Estonia and the two other Baltic countries are today AC connected to Russia and Belarus. Estonia is furthermore DC connected to Finland with 1,000 MW through EstLink 1 and 2 (see Figure 5).

Baltic States have a strategic goal to switch to synchronous operation with the Central European system, while having DC connections with Russian system (IPS/UPS). In this study connections between the Baltic States and Russia are assumed to be 3 x 500 MW. The interconnector from Lithuania to Kaliningrad is set to 700 MW. In practice the new capacities may be different, but this discussion is not the focus in the present study.

Figure 5:
Estonian transmission
system (www.elering.ee)

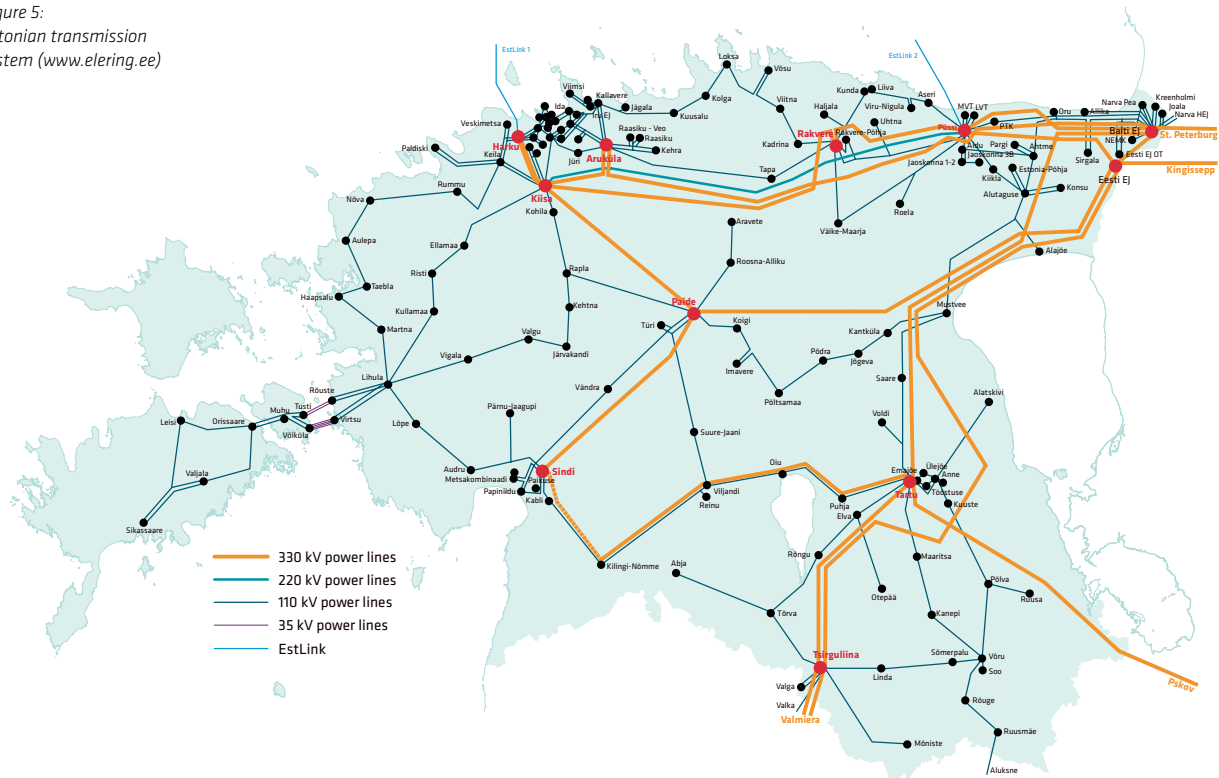

Auctioning of CO₂ quotas

Estonia and the other European countries will receive revenues from auctioning of CO₂ quotas as part of the carbon emissions trading scheme (ETS). It is a new type of revenue for the states, which may be difficult to predict.

In 2020 Estonia is expected to auction quotas corresponding to 9,4 Mt CO₂¹¹. In the scenarios studied here a CO₂ price of 15 €/ton in 2020 is assumed, corresponding to a revenue to the Estonian state of 141 M€. Revenues are not influenced by the national CO₂ emission. The CO₂ revenue is income for the state and can be used to reduce other taxes. The revenue can be considered as a transfer of value and is not included in the economic results in this study.

For the time after 2020 the amount of quotas is expected to decrease – and the CO₂ price is expected to increase.

3 The regional perspective

The Baltic Sea Region (as modelled in this study) holds a total population of around 165 million people with an aggregated gross electricity consumption of approx. 1,300 TWh. The majority of the countries in the Baltic Sea Region have well developed district heating systems but an unexploited potential to expand the district heating in parts of the region, particularly in Germany and to a lesser degree in Poland still remains¹². The gross demand for district heating in region is 2,050 PJ (570 TWh).

The Nordic countries and central Europe are presently well interconnected, but the three Baltic countries are currently only able to exchange energy with the Nordic countries through interconnectors between Estonia and Finland. However, new interconnectors are scheduled, which will connect Lithuania with Sweden (SwedLit/NordBalt, 2015) and Poland with Lithuania (LitPol, 2015).

The Baltic States have a strategic goal to switch to synchronous operation with the Central Europe and leave the IPS/UPS system. Studies of the costs and benefits of changing AC connection to the Central European area are underway.

Power exchanges

The Baltic States and the Nordic countries form a common power exchange, Nord Pool. Since 2010 Estonia has been a part of Nord Pool and as of January 2013 all Estonian electricity consumers are buying electricity from the market. Lithuania joined Nord Pool in 2012 and Latvia in June 2013. The Baltic States and the Nordic countries are thus now fully integrated – with competition of the electricity delivery hour by hour.

In Germany power is exchanged through the European Energy Exchange and in Poland through the Polish Power Exchange. Nord Pool and the European Energy Exchange are linked through so-called market coupling to ensure efficient use of existing cross-border interconnections.

The Russian market consists of eight wholesale generating companies of which six are based on thermal generation, a company with only hydro power plants (RusHydro) and a company with only nuclear power plants (Rosenergoatom). In addition, there are 14 so-called territorial generating companies consisting of the smaller power plants and combined heat and power plants (European Commission and Russian Ministry of Energy, 2011).

The long-term aim is according to the “Roadmap of the EU-Russia Energy Cooperation until 2050” to link the markets of the EU and Russia by 2050.

Decisions on gas interconnections and a regional LNG terminal are still pending. Different locations in the Estonia and in Finland have been studied. Lithuania will open a terminal in 2014.

EU

The Energy Provision¹³ in the EU Treaty stipulates that the EU energy policy shall aim to:

- ensure the functioning of the energy market;
- ensure security of energy supply in the Union;
- promote energy efficiency and energy saving and the development of new and renewable forms of energy; and
- promote the interconnection of energy networks.

The EU has a clear framework to steer its energy and climate policies up to 2020. This framework integrates different policy objectives such as reducing greenhouse gas (GHG) emissions, securing energy supply and supporting growth, competitiveness and jobs through a high technology, cost effective and resource efficient approach. These policy objectives are delivered by three headline targets for GHG emission reductions, renewable energy and energy savings (European Commission, 2013). In March 2013, the Commission issued a green paper on a 2030 framework for climate and energy policies. The green paper highlights energy efficiency improvements and smarter infrastructure as no regret options. In 2014 the EU Commission will propose goals for 2030 – probably with binding 2030 goals for CO₂ emissions and for renewable energy. The EU is likely to continue to be an important driver in energy policy.

The following briefly highlights key elements of the action plan for the EU Strategy for the Baltic Sea region and the EU directives for energy efficiency and renewable energy.

Action plan for the EU Strategy for the Baltic Sea Region

According to the “Commission Communication and Presidency Conclusions on the Energy Roadmap 2050”, the core elements in developing a low-carbon 2050 energy system are energy infrastructure, renewable sources of energy, energy efficiency, and security of supply at affordable prices. These aspects are also the cornerstones of long term-energy policy planning in the Baltic Sea region.

The second action plan for the EU Strategy for the Baltic Sea Region (EUSBSR) (European Commission, 2013b), published February 2013, lists 17 priority areas and 5 horizontal actions, which represent the main areas where the EUSBSR can contribute to improvements, either by tackling the main challenges or by seizing key opportunities.

Energy is one of the priority areas. The work of this priority area is coordinated by Denmark and Latvia and aims to improve the access to, and the efficiency and security of the energy markets. Two action areas specified for the current work period are as follows:

1. Action: Towards a well-functioning energy market:
 - Monitor the implementation of the Baltic Energy Market Interconnection Plan (BEMIP). Lead: Lithuania. Deadline: Progress report July 2013.
 - Sharing best practises of regional cooperation of BEMIP with EU Eastern Partnership countries. Lead: Lithuania. Deadline: Progress review November 2013.
 - Extend the Nordic electricity market model to the three Baltic States. Lead: Latvia. Deadline: 2013.
 - Potentially: Investment in infrastructure in the Baltic Sea Region. Lead: Denmark.
2. Action: Increase the use of renewable energy sources and promote energy efficiency:
 - Enhanced market integration of RES and best practice sharing. Lead: Latvia.
 - Promote measures to develop the usage of sustainable biofuels. Lead: Latvia.
 - Demonstration of coordinated offshore wind farm connection solutions, e.g. at Krieger's Flak (Denmark, Germany). Lead: Denmark. Deadline: 2018.
 - Promoting energy efficiency measures. Lead: Latvia. Deadline: 2015.
 - Potentially: Exploration of cooperation mechanisms. Lead: Sweden.

Energy efficiency

EU's new directive for energy efficiency (2012/27/EU) came into force in December 2012. As a consequence all Member States must implement an energy efficiency obligation or specify alternative instruments that will have same effect as the energy efficiency obligation, namely yielding an annual final energy reduction of 1,5% (article 7). The choice of instrument must be reported to the EU by 31st December 2013. The obliged parties should be energy distributors and/or retail energy sales companies and may offer subsidies or consultancy support to efficiently reduce consumption.

The directive for energy efficiency also requires that Member States by 31st December 2015 carry out a comprehensive assessment of cost-efficient potential for high efficiency cogeneration and efficient district heating/cooling (article 14). Furthermore, priority or guaranteed access plus priority dispatch should be granted for high efficiency cogeneration (article 15).

Renewable energy

The renewable energy directive (2009/28/EC) sets binding targets for the share of renewable energy sources in energy consumption in the EU Member States. The overall EU target is a 20% share of renewable energy sources that is further allocated to the countries with national targets varying from 10% to 49%. For Estonia the goal is 25%. The directive includes mechanisms that enable Member States to cooperate in order to reach their targets cost-efficiently. The European Commission wishes to increase the use of these mechanisms.

BASREC communiqué, May 2012

The Baltic Sea Region is politically and economically integrated and represented in a number of regional organisations and initiatives such as the Baltic Sea Region Energy Cooperation (BASREC)¹⁴.

- BASREC will in the current period 2012-2015 concentrate its cooperation on¹⁵:
- Security of energy supply and predictability of energy demand;
- Analysis of options for the development and integration of energy infrastructure in the region, in particular regional electricity and gas markets, including legal frameworks ;
- Increased energy efficiency and savings;
- Increased use of renewable resources available in the region, including integration of fluctuating wind power into the electricity system;
- Rehabilitation and development of district heating and cooling systems and CHP;
- Demonstration of transportation and storage of CO₂;
- Low-carbon energy policies up to 2050;
- Capacity building in the energy sector of the region.

¹⁴ BASREC – Baltic Sea Region Energy Cooperation Initiative, (initiated in 1999), includes the Governments of Denmark, Estonia, Finland, Germany, Iceland, Latvia, Lithuania, Norway, Poland, Russia and Sweden. The European Commission is represented by DG Transport and Energy. The participation in this work also involves the Council of Baltic Sea States (CBSS) and the Nordic Council of Ministers (NCM)

¹⁵ Communiqué adopted at the BASREC meeting of energy ministers in Berlin, 14-15 May 2012

BASREC studies

BASREC has in the period 2009-2011 instigated a number of studies aimed at enabling a well-functioning energy system within the Baltic Sea Region.

In 2009, the study 'Energy perspectives for the Baltic Sea region – Setting an agenda for the future', conducted by Nordic Council of Ministers, Baltic Development Forum and Ea Energy Analyses, in dialogue with among others BASREC and UBC, showed through small-tech and big-tech scenario analyses that stakeholder and country cooperation will reduce the cost of CO₂ reduction and that energy co-operation can indeed leave each country better off when implementing targets on climate protection, as well as in ensuring greater security of energy supply.

The follow-up study 'Energy perspectives for the Kaliningrad region as an integrated part of the Baltic Sea Region', 2010, concluded that closer cooperation, dialogue and joint energy planning initiatives are necessary elements, if the electricity system in the Baltic Sea Region is to develop in an economically and environmentally sustainable fashion; thus avoiding expensive, isolated solutions that are primarily driven by local demands for improved security of energy supply. This is particularly true when looking at the relationship between the EU countries and their Russian neighbour in the Baltic Sea Region.

Both studies have been discussed with politicians, civil servants, energy companies and other relevant stakeholders in the countries around the Baltic Sea Region including Russia. One outcome of the consultation of stakeholders was that the BASREC and the Nordic Council of Ministers launched a pilot regional training programme BALREPA¹⁶ in energy planning that ties a link between regional visions and scenario analyses, municipal energy planning, and implementation of concrete energy projects.

A third energy scenario study – 'Energy policy strategies of the Baltic sea Region for the post-Kyoto period', 2012 demonstrated that, given the insecurity over a post-Kyoto international climate agreement, the Baltic Sea Region can be a frontrunner in developing energy strategies for the post-Kyoto period.

The resulting strategies shall emphasize the coherence of climate policy and energy security objectives. As part of the study, a number of policy scenarios were evaluated against a reference scenario, with focus on economic impacts, implications for the regional energy system and the security of supply in the region for the year 2020 and beyond. The study focused on the electricity and district heating sectors in the Baltic Sea countries including North-West Russia and explored how the targets can be achieved at the least possible cost. The electricity market model Balmorel was used to simulate optimal dispatch and investments given the provision of framework conditions and technology cost. Data for the technologies that the model can choose between are drawn from a comprehensive technology catalogue.

The quantitative results of the scenario analyses were translated into concrete policy recommendations for designing energy policy of the region. The study results were presented at the COP17 in South Africa and at United Nations Conference on Sustainable Development in Rio, Brazil.

4 Methodology and scenarios

BALMOREL

The electricity system can be seen as a gigantic interconnected machine. The system must be in balance at all times and electricity markets are developing so this balance is achieved across national borders. District heating with combined heat and power (CHP) units are part of this big system. When one generator is increasing the output, another must reduce. E.g. an increase in power generation in Estonia may result in a reduction in Germany. In this study, the BALMOREL model is used to describe these connections and simulate different energy system development scenarios.

BALMOREL is an open source model for analysing the electricity and combined heat and power system in an international perspective. It is highly versatile and may be applied for long-term planning as well as shorter term operational analysis. The model has, for example, been used in relation to the analyses of the Harku-Sindi-Riga 330 kV line and a project on wind power in Estonia.

The BALMOREL model has been used for analyses of for instance security of electricity supply, the role of demand response, hydrogen technologies, wind power development, the role of natural gas, development of international electricity markets, market power, heat transmission and pricing, expansion of electricity transmission, international markets for green certificates and emission trading, electric vehicles in the energy system, and environmental policy evaluation.

BALMOREL is a least cost dispatch power system model. It is a “fundamental model” based on a detailed technical representation of the existing power system; power and heat generation units as well as the most important bottlenecks in the overall transmission grid. The main result is a least cost optimisation of the production pattern of all power units. The model, which was originally developed with a focus on the countries in the Baltic region, is particularly strong in modelling the combined heat and power system.

Figure 6:
Price areas in BALMOREL.
The lines indicate the
transmission lines in 2012.
Yellow lines are
DC connections

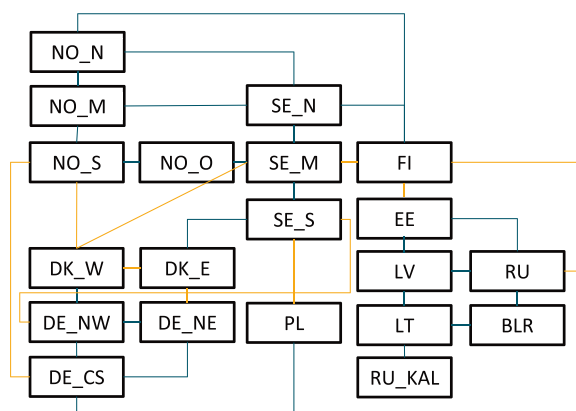

For this project the model area covers the Baltic States, the Nordic countries, Germany, Poland and North-West Russia. Each of these consists of one to four electricity price areas so that in total 23 price areas are included. All demand and generation are allocated to a specific price area. Belarus is included, but only as a transit country. The price areas and the initial connections between them are shown in Figure 6. In this initial set-up the Baltic States are only indirectly connected to Poland and Germany. However, planned transmissions lines between Sweden, Lithuania and Poland will change this in the short term.

Investments

In addition to simulating the dispatch of generation units, the model allows investments to be made in different new generation units (coal, gas, wind, PV, biomass, oil shale, nuclear, CCS) as well as in new interconnectors. However, certain constraints are placed on coal, nuclear and CCS investments as well as grid capacity investments. These constraints are policy driven and illustrate decisions on national level.

It is experienced that constraints on grid connections are necessary to obtain realistic investment suggestions from the model. Therefore, for example, a limit is imposed on the potential to expand grid connections within each five year period. This limit is 1,000 MW on sea cables and 3,000 MW for grid reinforcement on land – except in Germany where the limit is 6,000 MW. These limitations are introduced to ensure a gradual development of the grid in the region. The model only considers transmission capacity investments between the price areas with existing or planned capacities.

The BALMOREL model is myopic in its investment approach, in the sense that it does not explicitly consider revenues beyond the year of installation. This means that investments are undertaken in a given year if the annual revenue requirement (ARR) in that year is satisfied by the market. Since lead times for obtaining e.g. planning permission and environmental approval may be up to 5-10 years the model essentially operates with a foresight of that length.

A balanced risk and reward characteristic of the market is assumed, which means that the same ARR is applied to all technologies, specifically 0,12, which is equivalent to 10% internal rate for 20 years. This rate should reflect an investor's perspective.

In practice, this rate is contingent to the risks and rewards of the market, which may be different from technology to technology. For instance, unless there is a possibility to hedge the risk without too high risk premium, capital intensive investments such as wind or nuclear power investments may be more risk prone. Hedging could be achieved via feed-in tariffs, power purchase agreements or a competitive market for forwards/futures on electricity, etc.

Net present value

To sum up the economic results for the entire simulation period the net present value is presented. A 5% interest rate is used for this purpose. The interest rate is assumed to reflect the societal perspective. For the society there are fewer risks than for the private investor. This calls for a lower interest rate.

Time resolution

The base year is 2012¹⁷. In the period 2020-2030 the analyses are carried out with two year intervals and in the period 2030-2050 in five year intervals (see Figure 7).

The model will be operated at 12x6 time steps per year. This gives 72 steps per year, which is much less than the 8,760 (hourly) steps that are used for operational analyses. However, 72 steps per year are appropriate for a long-term scenario study. The time aggregation of the model ensures that critical hours, e.g. peak demand or hours with high or low wind power generation, are considered by the model.

Figure 7:
Symbolic presentation
of the year used for
BALMOREL modelling.
2012 is the historical year
and this is the same for all
scenarios. Next calculation
is for 2020 and here the
model is allowed to invest
in generation capacity.
From 2026 the model
can also invest in
transmission capacity

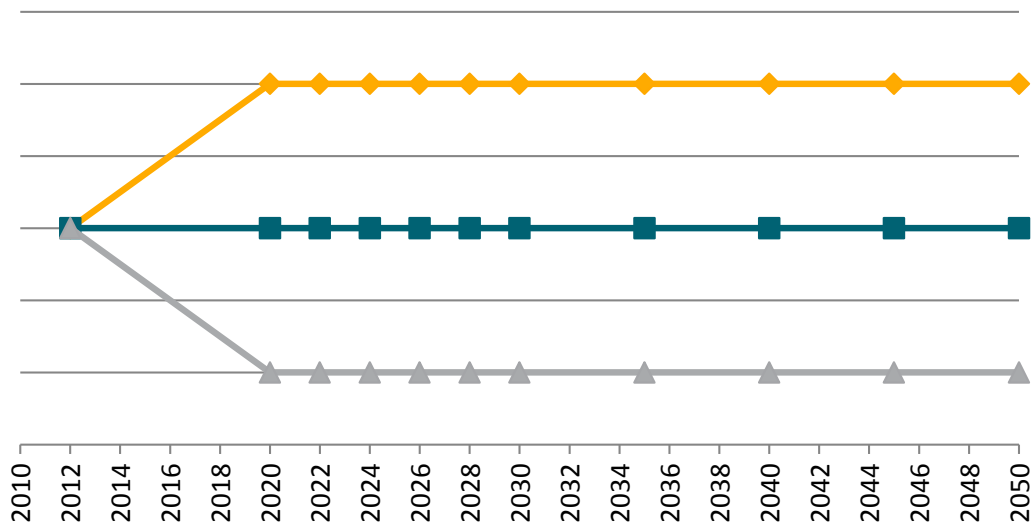

Economic analysis

BALMOREL is also capable of reflecting political framework conditions such as taxes, quotas and subsidies, and to assess the economic consequences for different stakeholder groups such as consumers, producers, grid owners, countries or the region as a whole. In this study taxes and subsidies are not analysed. The result of the CO₂ quota system is described as input in form of CO₂ prices.

Economic consequences are described for consumers, generators and TSO for each country.

Because the focus is the long term, existing tariffs are not included. It is assumed that future tariffs will ideally reflect the marginal cost of supplying electricity and district heating. Today the Estonian regulation requires that no fixed tariff is paid by consumers of district heating and that the tariff should be the same for all end-users. This is far from cost-reflective for the operation of district heating.

Levelised cost of energy

The model computes optimal investments in new generation based on a least cost approach. This optimisation is carried out based on the framework conditions the model has been given. The figures below show the levelised costs of energy applying the framework assumptions used in the model for 2020 (CO₂-price of 15 €/ton). It can be seen that biomass is attractive, especially in CHP plants. After 2020, when the CO₂ price increases, wind power will be the most attractive technology for electricity generation. It should also be noted that the balance of cost between coal, natural gas and biomass based generation is very close. Relatively small changes in the price difference between these fuels can, therefore, make one more attractive than the other.

Figure 8:
Levelised cost of energy for CHP plants in 2020 with a CO₂ price of 15 EUR/tonne. 6000 full load hours and heat price of 29€/MWh assumed. (EXT-extraction turbine; BP-back pressure turbine)

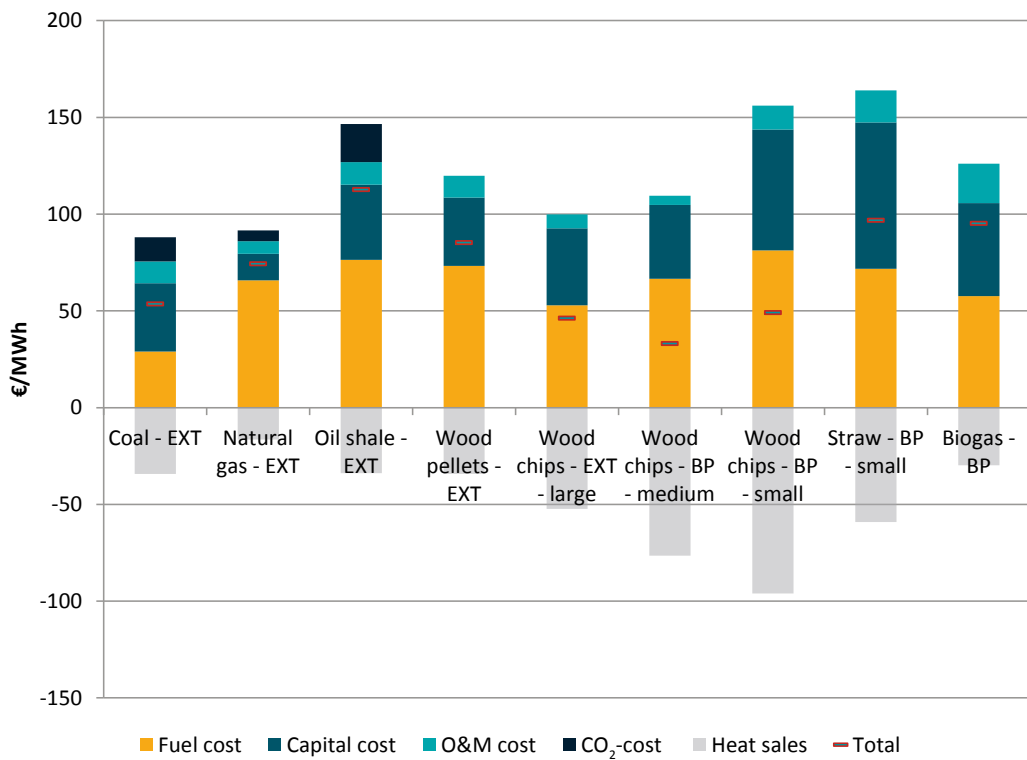
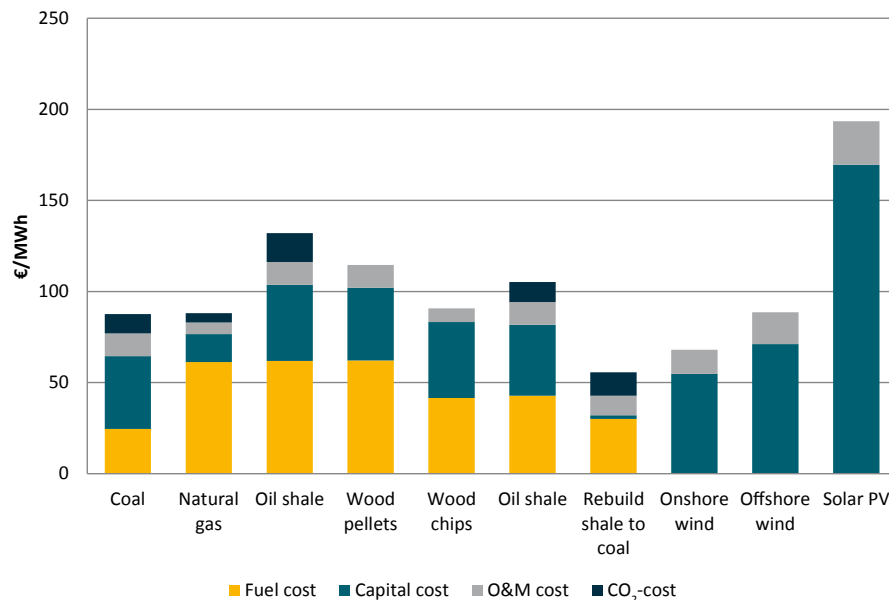

Figure 9:
Levelised cost of energy for
condensing plants, solar
panels and wind turbines
in 2020 with a CO₂
price of 15 EUR/ton. 6000
full load hours assumed



Understanding model results

BALMOREL model represents a simplification of reality. Output is consistent and in most cases easy to understand. A major advantage is that all scenarios are computed with optimal results – so any difference can be attributed to model input, e.g. a price change or a rule included in one calculation.

However, it is important to understand some impacts of the simplifications:

- Results may be too smooth because the model finds optimal solutions. Market power, random variations, different future expectations and strategies may give more complex results.
- Tipping point: When one technology becomes more attractive than competing technologies, the model tends to shift 100% to the winning technology, e.g. when investing in new generation. In real life more friction may exist, due to companies' different strategies, different competences or other differences not included in the model.

The scenarios

Five Estonian Electricity and CHP sector scenarios are analysed in this study. The five scenarios are a selection and modification from the eight scenarios analysed in the preceding study by Ea Energy Analyses¹⁸. Figure 10 illustrates the scenarios in the present study. Each scenario differs from the base scenario by essentially one assumption. This approach facilitates analysis, as differences in the results can be attributed to the one difference. Below the major assumptions and inputs for the different scenarios are presented. All EU countries have goals for renewable energy in 2020. For all other countries, except Estonia, the technology specific 2020 goals are taken from the national renewable energy action plans (NREAP) as reported to the EU¹⁹. For Estonia the model is free to decide how to fulfil the requirement of 25%²⁰ renewable energy in 2020 in the most cost efficient way. This 2020 assumption is applied in all scenarios and is also set as a minimum renewable energy requirement for the period beyond 2020 in the whole region.

Figure 10:
Five studied electricity
sector development
scenarios

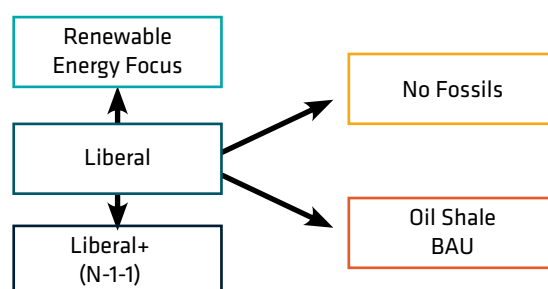

Liberal market scenario

The liberal market scenario represents the base case of market based development of the electricity sector. The scenario is stripped of any subsidies, which could distort the market, besides the already agreed EU 2020 goals. The liberal market scenario acts as a starting point for developing other scenarios.

RE focus scenario

The renewable energy focus scenario is equal to the liberal market scenario, except national targets are set for the renewable energy share of heat and electricity generation in Estonia. The share of renewable energy in Estonia in 2030 is set to 50% and in 2050 to 100% of the electricity and district heating demand. Table 2 illustrates the linear growth in the renewable energy share targets across the modelling years.

Additional constraint is that no new investments in fossil fuelled technologies are allowed in Estonia. An exception to this is the rebuilding of existing CFB oil shale power plants to use coal as a fuel. The exception is granted due to the superior environmental performance of coal compared to oil shale.

Table 2:
Renewable energy share target in Estonia for modelling years

Year	2020	2022	2024	2026	2028	2030	2035	2040	2045	2050
Renewable energy share, %	17,4	24	30	37	43	50	63	75	88	100

Oil Shale BAU scenario

In the oil shale BAU scenario a gradual movement from using oil shale in electricity generation to using it in oil production is assumed. The by-product of shale oil production - retort gas - is assumed to be used in electricity generation. Retort gas is a fuel similar to natural gas and can be burnt in e.g. gas engines to produce electricity. Table 3 illustrates the assumed oil shale resource for electricity generation and the corresponding retort gas resource for electricity generation. The oil shale is assumed to be priced at the mining cost.

It is assumed that three units producing shale oil are commissioned by 2020 and in the period from 2020 to 2030 one unit comes online every second year giving a total of eight units by 2030. The entire oil shale resource of 20 Mt/year is utilised by these refineries in 2030 and all retort gas is used for electricity generation. In other regards, the scenario is the same as the liberal market scenario.

Table 3:
Oil shale and retort gas resource for electricity generation in Estonia for the modelling years

Year	2020	2022	2024	2026	2028	2030	2035	2040	2045	2050
Oil shale resource for electricity generation, TWh	23,6	18,9	14,2	9,5	4,8	0,1	0	0	0	0
Retort gas resource for electricity generation, TWh	7,3	8,3	9,3	10,3	11,2	12,2	12,2	12,2	12,2	12,2

Liberal+ scenario

The liberal+ scenario is a scenario with enhanced security of supply requirements. Compared to the liberal scenario this scenario has an additional constraint to satisfy at all times the N-1-1²¹ security constraint. The N-1-1 situation is chosen, where two largest power system elements in Estonian are unavailable. For this study, these elements are assumed to be EstLink 2 and the Estonia-Latvia third interconnector. In the described stress situation, Estonia would have 1100 MW of import capability²². This translates into a constraint by which Estonia must have inland generation capacity amounting to the peak demand minus 1100 MW.

No Fossils scenario

In the no fossils scenario, all fossil fuels are prohibited in Estonia. This means no burning of fossil fuels in the existing power plants as well as no new investments in fossil fuel power plants. Exceptions to this are municipal waste and peat. The scenario is meant to illustrate a very radical phase out of fossil fuels in Estonia. It is a stronger environmental scenario than the RE focus scenario. Other assumptions are the same as in the liberal scenario.

Constant parameters

In all scenarios the energy prices are expected to develop as forecasted in the IEA's New Policies Scenario (IEA, 2012). This is a simplification, which makes it easier to compare results across scenarios. In practise several mechanisms of feedback may exist, e.g. if the focus on reducing climate change is global, lower fossil fuel prices can be expected because of the massive interest in reducing CO₂ emissions leading to decreased demand for fossil fuels.

Also, technology costs are kept constant in all scenarios. In practise it is easy to understand that e.g. the cost of wind power and CCS would be influenced by the demand for these technologies. Such feedback is ignored in the scenarios.

The two amendments above have small implications for the five scenarios analysed in the present study. Here the regional assumptions are fixed and the scenarios differ in the assumptions for Estonia. Actions in Estonia can have only a minor effect on the fuel prices and technology developments.

Market designs

In selecting the scenarios some discussions have been prioritised, while other important issues have not been included. The use of an electricity market design in Russia with a component of a capacity market can be very important for the flow of electricity between Russia and Baltic States. On the Russian/Finland border electricity flow to Finland has been reduced during peak hours after the introduction of the Russian capacity market. However, it has been decided not to focus on the influence of capacity markets in this study.

It is difficult to predict the future design of both European and Russian electricity markets. In the simulations an electricity market similar to the current Nord Pool market is assumed in all years. This is a market, where the price in each area is defined as the marginal cost of supplying electricity (called energy-only-market with marginal pricing)²³. Investments in new capacity are expected to take place when the prices are sufficient to cover both operating and capital costs. This set-up is assumed to be relevant, also in 2030 and 2050.

Input data

A huge amount of input data is used in computing the scenarios. This includes fuel prices and CO₂ prices, as well as technology data for generation technologies and transmission lines. Fuel and CO₂ prices are generally based on the New Policy scenario in the 2013 World Energy Outlook (IEA, 2013) (see Figure 11 and Figure 12). Technology data (generation) are mainly based on data from a publication by the Danish Energy Agency (Danish Energy Agency and Energinet.dk, 2012) supplemented with Estonian cost assumption on a few technologies (see Figure 8 and Figure 9 for levelised cost of energy). Cost of transmission lines are based on Ea Energy Analyses study on recent interconnection projects (Ea Energy Analyses, 2012).

Figure 11:
Prognosis for CO₂ quota
prices (until 2035 IEA
New policies scenario;
2035-2050 linear
extrapolation of
IEA prognosis)

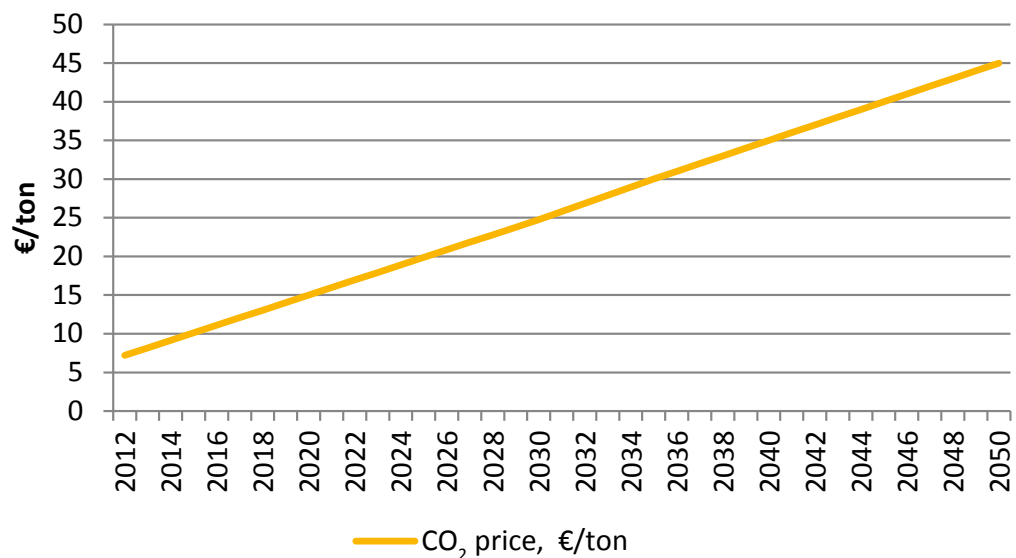
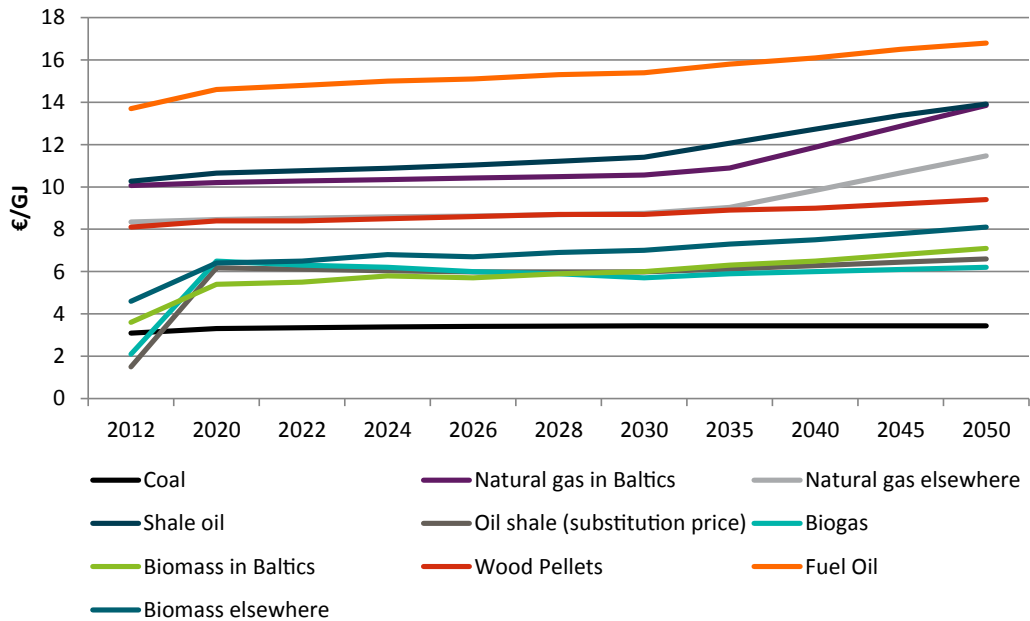

Figure 12:
Fuel cost assumptions
(fossil fuel prices until 2035 IEA New policies scenario; 2035-2050 linear extrapolation of IEA prognosis; biomass prices from Danish Energy Agency; natural gas for Baltics and biogas price according to Estonian expert group assumptions; shale oil price follows oil IEA oil price trends)



Price of oil shale

As presently an important fuel in electricity generation, price assumptions for oil shale have large implications for the scenarios. If oil shale can only be used for power generation, it is natural to set the cost of oil shale to the mining costs. This procedure is part of the background for the historical large Estonian oil shale based electricity generation. However, since oil shale can also be used for producing shale oil, the opportunity cost must be considered. Therefore, a substitution price is calculated to account for the opportunity cost. Only if electricity generation is profitable based on the substitution price, should the oil shale be used for electricity generation. With the current price of oil around 100 \$/barrel, it is more profitable to produce shale oil than electricity.

For this study a simplified substitution price has been calculated. The short run substitution price is defined as:

$$\text{Fuel oil price} \times \text{oil plant efficiency} - \text{oil shale plant OPEX} - \text{plant CO}_2 \text{ costs}$$

Plant efficiency is set to 70% and OPEX to 21 €/ton. With these values the substitution price is a function of oil price (positively related) and CO₂ price (negatively related). Note that the power plant also pays the CO₂ price.

Electricity should be generated by oil shale when the electricity price is higher than:

$$\text{Oil shale substitution price} / \text{plant efficiency} + \text{OPEX} + \text{CO}_2 \text{ costs}$$

Demand

The demand for electricity in the model region countries (excluding Estonia) is estimated to grow steadily and in connection with economic development (Table 4). The economic growth in the less developed countries of the region is assumed higher than for the more developed countries. This represents the assumption of less developed countries catching-up in economic development to the more developed countries.

Table 4:
Assumptions on average annual economic growth between 2010 and 2050

Denmark	Germany	Lithuania	Latvia	Finland	Sweden	Poland	Norway
1,2%	0,8%	2,7%	2,5%	1,3%	1,5%	2,7%	1,2%

For Estonia, the electricity and heat demand growth has been estimated based on studies of energy savings potential. The studies focused on energy use in buildings (Kurnitski, et al., 2013), district heating (Estonian Development Fund, 2013a) and transportation (Jüssi, M., et al., 2013).

For electricity demand, three different scenarios were defined based on the assumed scale of state level

involvement. The underlying principle was that larger involvement by state allows for more energy saving measures and leads to lower electricity demand. However, this is countered by larger electricity consumption in transportation sector, as with state level measures, the share of electric vehicles is increased. The scenario with the largest demand out of the three was chosen for this scenario analysis. Figure 13 illustrates the electricity demand forecast for Estonia with transmission and distribution losses.

Figure 13:
Forecast for Estonian
electricity demand with
the transmission and
distribution losses

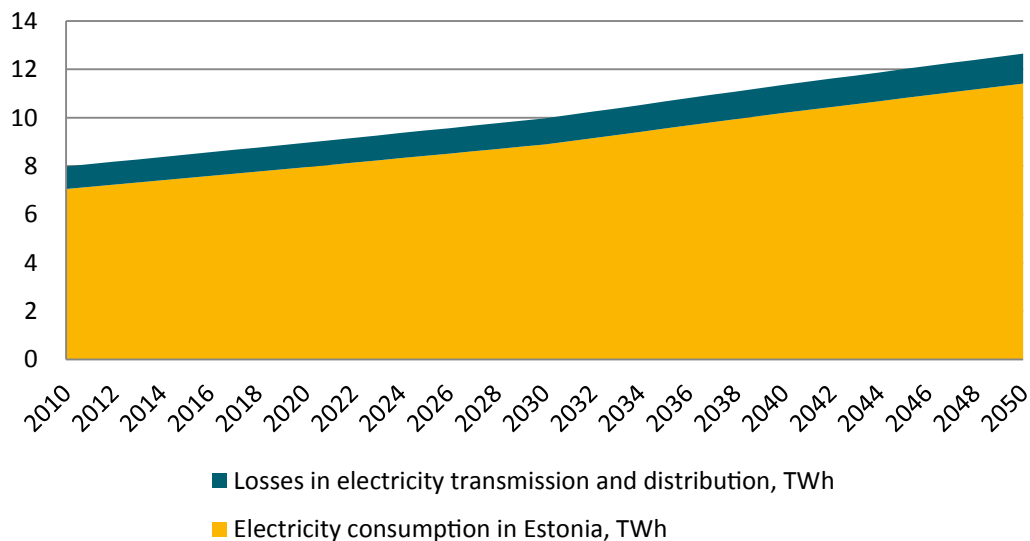

The district heating demand used in the model is based on the district heating (DH) study by Estonian Development Fund (Estonian Development Fund, 2013a). The study identified the present situation in the DH sector, including the heat demand by DH areas. The areas with estimated potential for combined heat and power (CHP) production are included in the Balmorel model. The criteria for CHP potential was chosen to be 20 GWh of heat demand. The heat demand is assumed to decrease by one percent per year from the 2012 real consumption.

In accordance with the EU directive on the energy performance of buildings (Directive 2010/31/EU), some distributed electricity generation is expected from 2020 and onwards. This distributed generation is seen as a part of the nearly zero-energy buildings initiative. For this study, in total of 150 MW of additional distributed generation is assumed for 2030, and 300 MW for 2050. The distributed generation consists of three technologies, one-third each. The technologies are wood gasification cogeneration, wind turbines and photovoltaic panels. The distributed generation is assumed to amount to 5% of net consumption in 2030 and 10% in 2050. The heat generation from wood gasification is assumed to be 460 GWh in 2030 and 920 GWh in 2050, and is expected to be local, therefore not reducing the total district heating demand.

5 Scenario results

5.1 RESULTS - MODEL AREA

The modelling area comprises of the Baltic States, Nordic countries, Germany, Poland and the North-western Russia. This section presents the modelling results and major conclusions for the modelling area.

The electricity production fuel mixes and country balances are presented on Figure 14. The figure represents the liberal market scenario for the year 2030. The graph also illustrates the main drivers for the electricity market: the different resources and generation technologies in the different countries, e.g. hydro in Norway, wind in Denmark, and coal in Poland etc. Without such difference there would be less need for transmission lines and less benefit from interconnected markets.

A major tendency is the energy flow from the Nordic countries to the Central Europe. This is mainly facilitated by the surplus in Sweden, Norway and Denmark, where excess hydro, nuclear and wind power is available. Germany and Poland are the main recipients of this energy. Germany is an importer due to the phase-out of the nuclear power plants and present high share of coal power plants, which competitiveness is reduced by the rising CO₂ costs. Poland is also an importer of low marginal cost energy due to present very high share of coal power.

RE goals beyond 2020

The EU goals for 2020 motivate expansion of renewable energy throughout the model area. The development of PV is the same in all scenarios - 25,706 MW PV are expected in 2020. This investment is motivated by EU 2020 goals. The 2020 requirements are assumed to exist for the entire period 2020-2050, and this motivates the re-investment in PV at the end of the life time of the first round of investment. No commercial investments in PV take place after 2020. This indicates that solar PV has difficulties to be competitive in the modelling region without subsidies, under the assumptions in the present analysis.

Figure 14:
Electricity generation in 2030, liberal scenario. Values indicate national generation (and export) in TWh²⁴

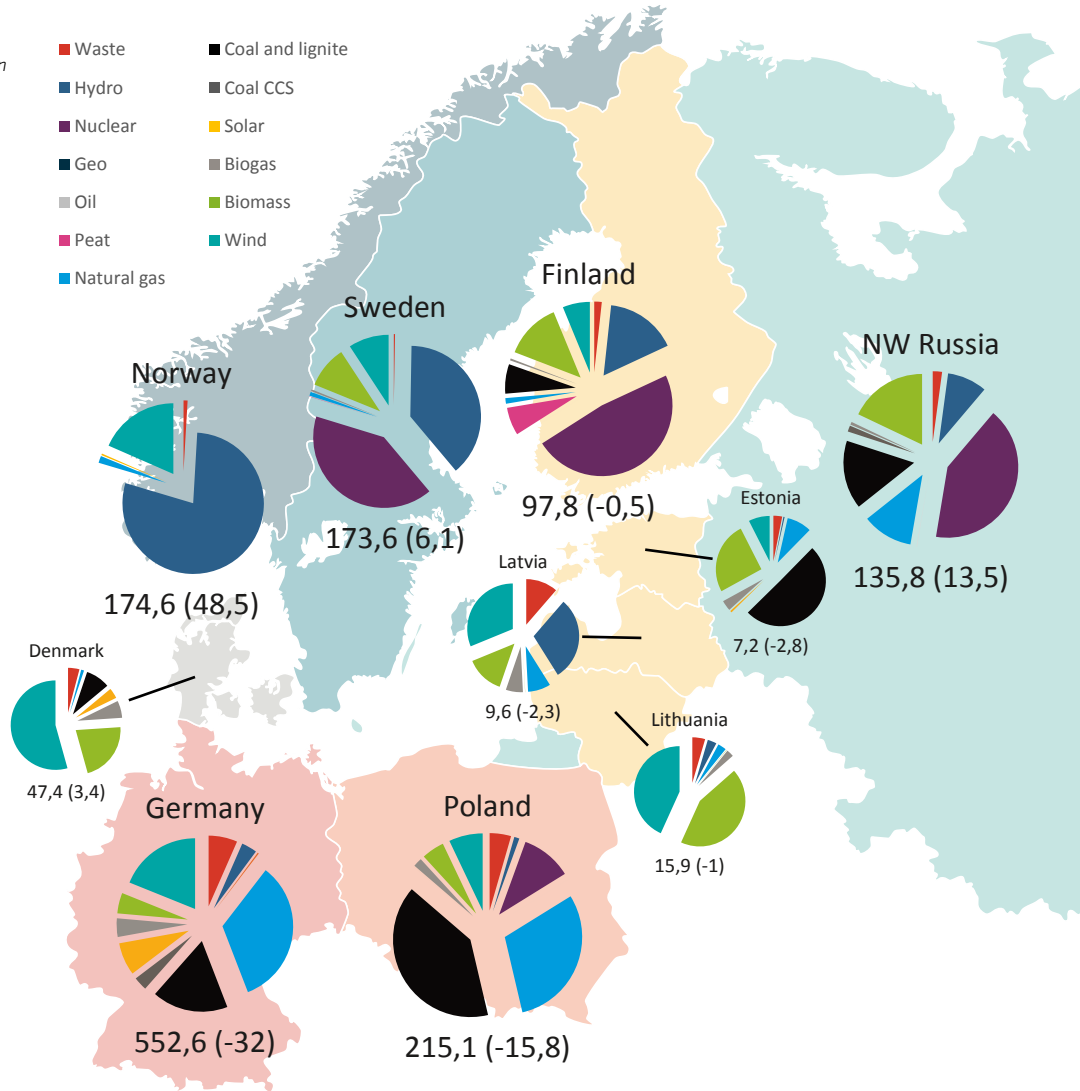

CCS attractiveness

The model is allowed to invest in CCS from 2030. With the assumed costs and efficiencies of CCS the model invests in 20,000 MW CCS from 2030 to 2050 in all scenarios. The CCS technology is used on the coal power plants, while the technology is also considered for gas and biomass power plants.

When CCS becomes attractive it will influence the power flow and motivate new transmission investments between areas with CCS and areas without this possibility (because of lack of adequate storage sites, which is the case for e.g. Estonia). It must be stressed that the assumed costs of CCS are very uncertain. We have used a cost estimate of a new power plant with CCS to be 3 M€/MW_{electricity} and 9 percentage point loss of efficiency. Variable cost for operation and maintenance is expected to be 18€/MWh_{electricity}. The investment is 50% higher than for a plant without CCS and the O&M costs are seven times higher.

Figure 15:
CO₂ emissions in model area in liberal scenario

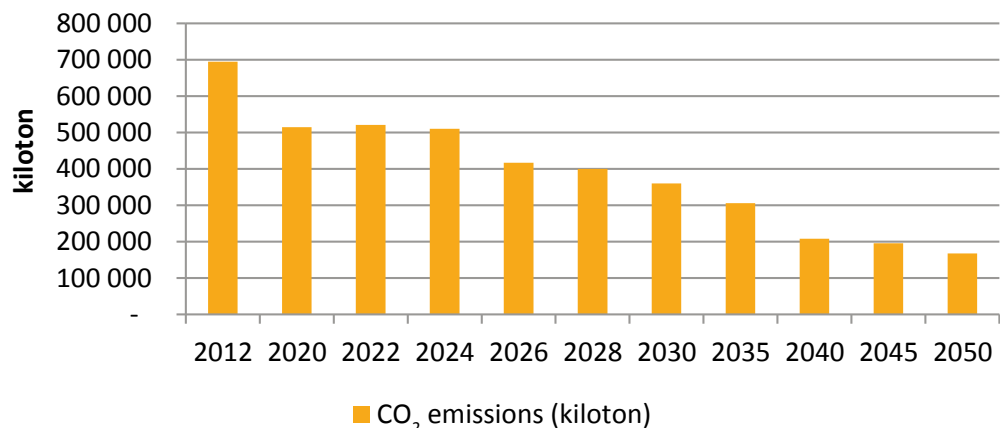

The resulting CO₂ emissions in the model area start at 700 Mt in 2012, and is reduced to 170 Mt in 2050 in the liberal scenario. EU Roadmaps for 2050 take the starting point on limiting the atmospheric warming to 2°C. This translates into 80-95% reduction of greenhouse gases by 2050 compared to 1990 (European Commission, 2013a). The electricity and district heating sectors are expected to be almost CO₂ neutral in this roadmap.

The steep reduction in CO₂ emission from 2012 to 2020 is due to the EU 2020 goals, but also due to the optimal investment in new generation from 2020. A model run with the liberal scenario without the 2020 goals indicates 79% of the reduction from 2012 to 2020 is related to the optimal investments in generation. The rest is due to the 2020 goals for renewable energy²⁵.

Prices

Electricity wholesale prices are defined as the marginal cost of supplying electricity in each price area. This corresponds to the way that the spot price is calculated on Nord Pool Spot. Figure 16 illustrates the yearly average wholesale electricity prices for countries close to Estonia. The prices are given for the liberal market scenario. As the scenarios have differences only regarding Estonia, the prices are very similar across scenarios. It can be noted that the average electricity prices are expected to be very similar across countries, fairly more so than presently. This is a result of well-functioning and strongly connected regional electricity market, where prices are bound to converge. Further, it can be observed that the increase in the electricity price in real terms in the period of 2020-2050 is quite limited. In the light of CO₂ price tripling and fuel price increases, the electricity price increase is relatively small. This is possible due to assumed technological development and movement away from the fossil fuels.

Figure 16:
The yearly average
electricity prices
for countries in
the liberal scenario
(real prices EUR2011)

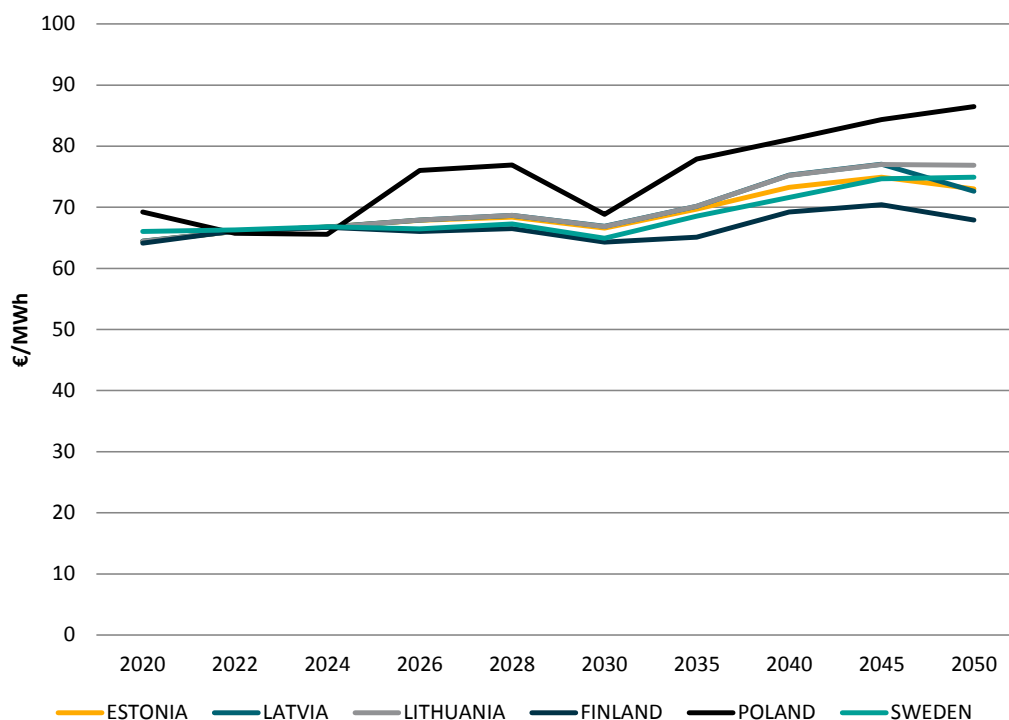

The prices are expected to be considerably higher than in the present. However, it must be noted that the simulations are made subsidy free and the prices reflect the full cost of supplying the demand. This means that the electricity prices are allowed to the economically efficient levels, to support the necessary investments in generation capacity. It is widely acknowledged that the present wholesale prices are not sufficient for new investments. Therefore, if the energy-only markets are to induce new investments, the wholesale prices must increase. As an alternative, capacity markets are discussed for the improvement of the investment environment.

Investments in transmission

Until 2025 the assumed expansion of transmission is based on planned investments. From 2026 the model can invest in new transmission capacity²⁶. As the scenarios are different only in regards to Estonian assumptions, the regional development in the transmission capacity is very similar across all the scenarios. The Estonian transmission investments are largest in the liberal scenario, where the deficit is

25

When the model is allowed to invest it is easy to compare two scenarios. Both scenarios are optimal and any difference is due to the parameter that has been changed. However, comparing 2012 and 2020 can be confusing because the model is not allowed to invest in 2012. Therefore such comparison should be done with caution. Model based investments are a central feature in this study. However, it is clear that real life is less optimal than the model world

the largest, due to no subsidised generation capacity. The new transmission capacity is between Estonia and Finland. It amounts to about 500 MW and is built in the period of 2035-2050. This implies that the assumed transmission capacity by 2025 is sufficient for a period.

On the other extreme, there is no new transmission capacity with Estonia in the oil shale BAU scenario. This is due to the relative balance of the Estonian power system and therefore little need for capacity for imports.

5.2 RESULTS – ESTONIA

Electricity generation in Estonia can be seen in Figure 17. In all scenarios, but the oil shale BAU scenario, the use of oil shale is minimised in 2020 and thereafter. Reduction in use of oil shale for electricity production is caused by high opportunity cost. It is economically better to use the oil shale in oil production. Instead, the electricity is generated from coal, in the CFB units in Narva power plants. It is assumed, that coal can be burnt in unit 8 in Eesti PP, unit 11 in Balti PP and in the new Auvere unit, with relatively small capital investments. In the no fossils scenario, it is assumed that biomass can be burnt in the same three units.

Figure 17:
Electricity generation
in Estonia in the
five scenarios

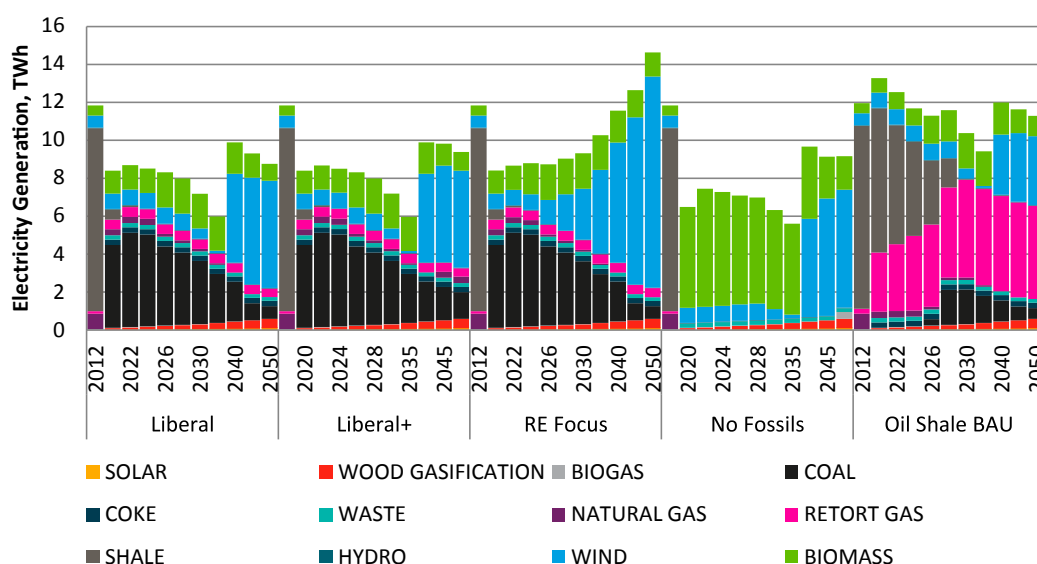

Generation in liberal+ scenario differs relatively little from the liberal market scenario. As the N-1-1 activates only in 2045 and 2050, there is some additional generation during that period. The RE focus scenario has earlier and more gradual wind power development than the liberal scenario. The wind generation also peaks at the high level of 11 TWh by 2050. Rest of the electricity generation is relatively unchanged. In the oil shale scenario, there is a significant amount of electricity produced from oil shale and retort gas. The generation from retort gas peaks at 6,4 TWh by 2030. Due to smaller deficit in the oil shale scenario, the wind development is slower in the end of the period, compared to the liberal scenario.

In the no fossils scenario the three Narva CFB units are rebuilt to use biomass. This results in significant electricity production from biomass. The amount of biomass used in the electricity production exceeds the estimated Estonian energy biomass resource and implies some need for biomass imports.

Electricity export

The Estonian electricity demand is assumed to be 9,0 TWh in 2020 and increasing to 12,7 TWh in 2050 (including transmission and distribution losses). The local generation of electricity is sold on the (international) market. Figure 18 shows the net exchange of electricity in Estonia. Looking at the liberal and liberal+ scenarios, Estonia is in clear deficit. It can be observed, that for 2050, the deficit is smaller in liberal+ scenario due to some forced investments to satisfy the N-1-1 criterion. In the RE focus scenario, Estonia is close to balance. This is due to investments in wind power capacities (Figure 21).

In the oil shale BAU scenario significant exports take place in the beginning of the period. This is due to continued use of oil shale in electricity production and using retort gas for electricity production. As seen from Figure 17, the retort gas based generation reaches up to 5,2 TWh. The reduction in generation from coal and increase in demand cause the export to turn into import by 2050. Imports in 2050 are also affected by CCS and nuclear power development in the surrounding systems. It is unclear how these technologies will develop, which means there is uncertainty in relation to this result.

The no fossils scenario shows significant imports throughout the period. This is expected, as removing fossil fuels from the picture makes it difficult to produce electricity in Estonia.

Figure 18:
Estonian electricity
export balance in all five
scenarios for 2020, 2030
and 2050 (TWh/year).
Positive numbers are
export of electricity

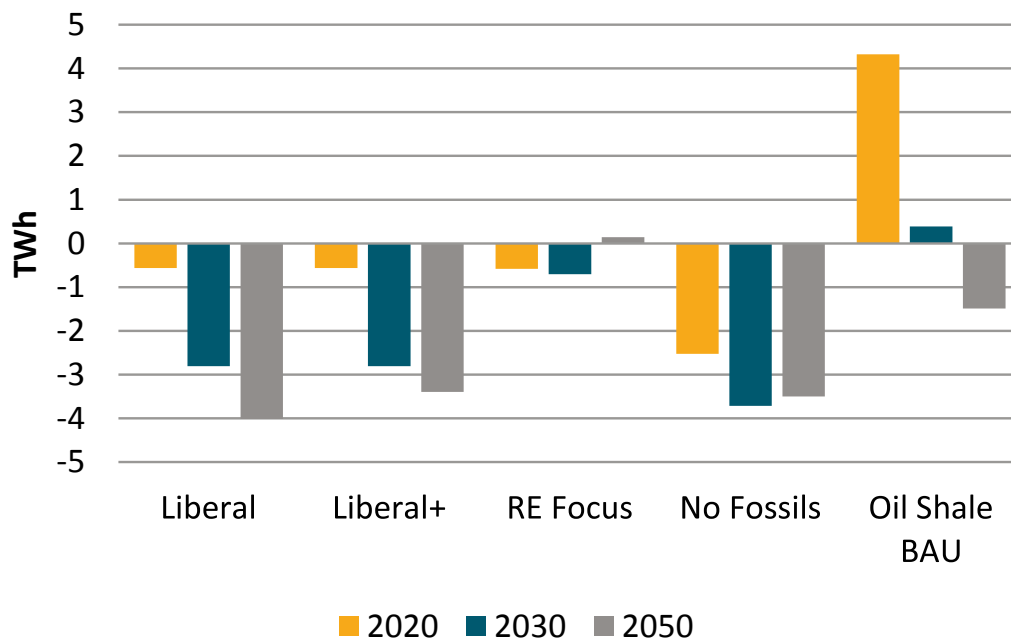

The country specific yearly electricity export balance in Figure 19 shows the Estonian exchange with the neighbouring countries. In all scenarios Estonia is importing power from Finland, which is transit power from Norway and Sweden. Norway and Sweden both have large exports due to expansion of renewables, hydro power and Swedish nuclear power. This is low marginal cost electricity and therefore very competitive on the regional power market.

The connection to Latvia is in most cases used for export, however, some imports can be foreseen towards 2050. With Russia there are imports as well as exports, depending on the scenario and specific year.

Figure 19:
Estonian country specific
electricity export balance
in all eight scenarios for
2020, 2030 and 2050
(TWh/year). Positive
numbers are export
of electricity

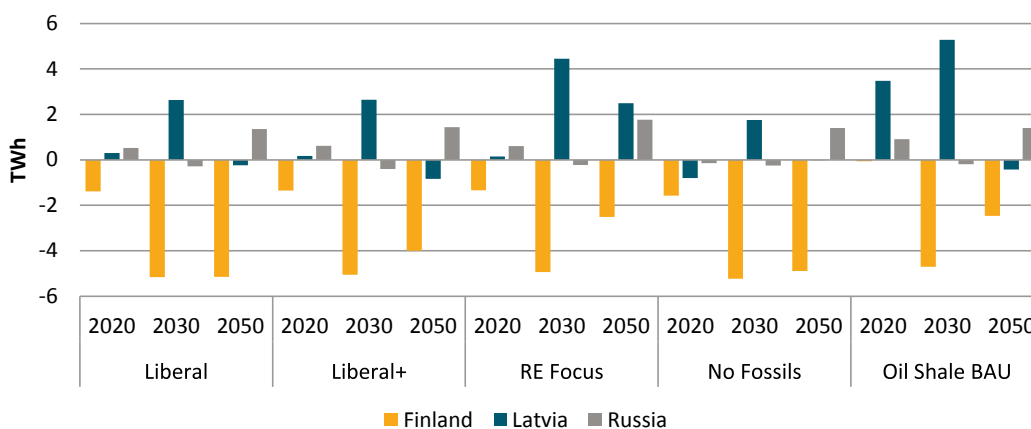

CO₂ emissions

Pricing oil shale according to its substitution price results in reduction of CO₂ emissions from the power and district heating sector in most of the scenarios (see Figure 20). At the same time, as seen from Figure 17, the electricity production is also reduced. It should be noted that while the use of oil shale is reduced in the electricity and district heating sector, the total oil shale mined may be unchanged (20 Mt/year) because of the increased use of oil shale for the production of shale oil.

From Figure 20 it can be observed that the CO₂ emissions are the largest in the oil shale BAU scenario. This is due to the continued electricity production from oil shale and additional generation from retort gas. Retort gas is similar to natural gas in the CO₂ emission intensity. The higher emissions translate also to significantly higher electricity production and exports of electricity.

Figure 20:
CO₂ emissions from
electricity generation and
CHP-s in Estonia by fuel in
the five scenarios

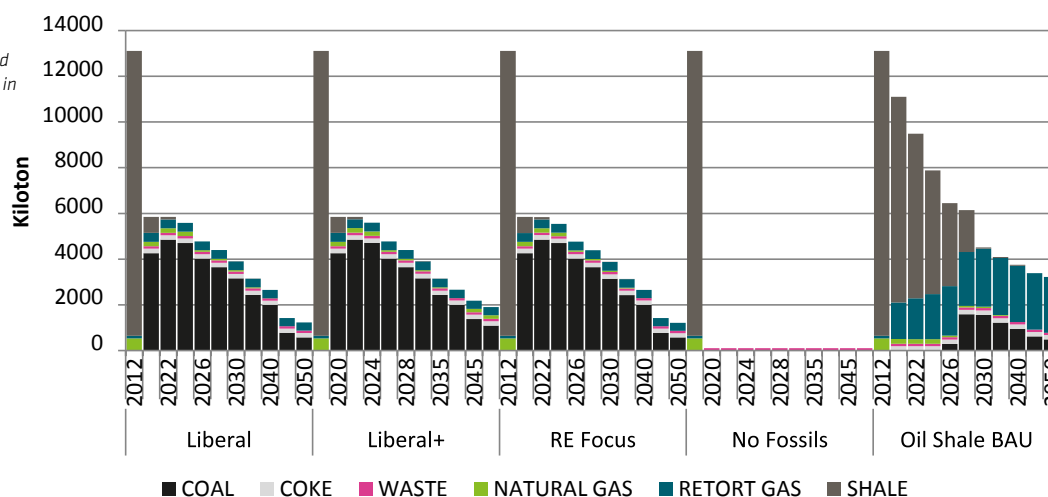

With significant imports in the liberal and liberal+ scenarios, it is relevant to examine the CO₂ intensity of the imported electricity. As seen from Figure 19, most of the imports come from Finland. Finnish average emissions from electricity production vary between 320 kgCO₂/MWh in 2020 and 24 kgCO₂/MWh in 2050. However, as Finland is a relatively balanced system throughout the period, the imports may be attributed to Sweden and Norway, where large surpluses exist (refer to Figure 14). Sweden and Norway have very low CO₂ intensity in electricity production, staying below 20 kgCO₂/MWh for the period.

Investments in new generation capacity

The Estonian 2020 renewable energy goals are reached without subsidies in all scenarios. The goals are reached by commercial investments and operation. Note that this result is simulated under optimal electricity market conditions. This means an efficient and subsidy free energy-only market throughout the whole modelling region. It also means that the power price includes all costs, which in the longer term are the long run marginal costs. Estonian renewable electricity goal of 17,4%²⁷ can be achieved by existing and decided wind power investments and about 125 MW of additional biomass CHP capacity.

Investments in significant amounts of wind power in Estonia take place during 2040-2045 in scenarios other than renewable energy focus. In the renewable energy focus scenario the wind investments are spread out through the whole period, starting from 2026.

The N-1-1 constraint in the liberal+ scenario becomes active in 2045 and 2050, where mainly natural gas based capacity is built to fulfil the requirement. Gas based capacity is a natural choice due to low capital cost, as security of supply capacities get few operating hours. Some coal based CHP capacity is built in Narva to replace the decommissioned cogeneration (Balti PP unit 11).

Estonia has historically been exporting electricity produced from the local oil shale resources. In most of the modelled scenarios oil shale is priced according to its substitution price. The substitution price is much higher than the mining costs, indicating that the resource should be used for producing shale oil and not electricity. Existing oil shale based power plants are not used intensively after 2020 in other scenarios but oil shale BAU. Also, no re-investments in new oil shale based power plants take place. Investment in rebuilding 660 MW existing oil shale plants²⁸ to coal takes place in 2020 in three scenarios and to biomass in one scenario.

27 National Renewable Energy Action Plan (Ministry of Economic Affairs and Communications, 2010)
28 The model is allowed to rebuild the Narva 8, 11 and Auvere units. These are the three newest oil shale plants with CFB boilers. The rebuilding costs to coal are assumed to be 5% of the investment costs of a new oil shale power plant and to biomass 0,4 MEUR/MW

In the oil shale BAU scenario it is assumed that three units producing shale oil are commissioned by 2020 and in the period from 2020 to 2030 one unit comes online every second year giving a total of eight units by 2030. These units are estimated to have a total electricity capacity of 625 MW and will run continually towards 2050.

Figure 21: Investment in electricity generation capacity in Estonia. A missing year refers to no investments in that particular year

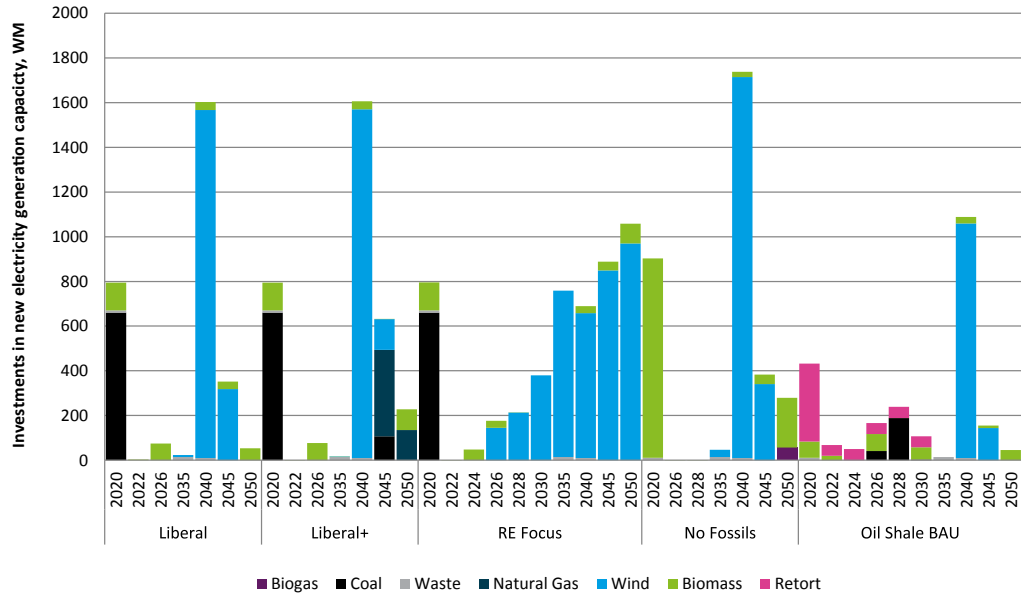
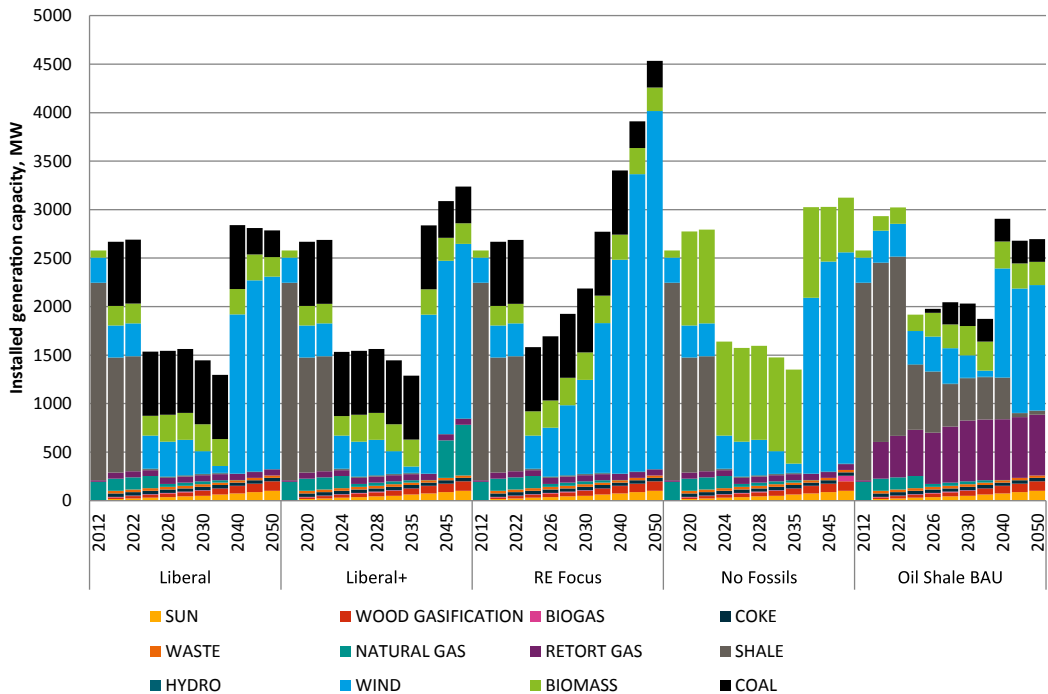

Figure 22 shows the installed electricity generation capacity in Estonia. This includes the presently existing and planned capacities with assumed decommissioning schedules, as well as the new investments introduced by the model. The model investments are decommissioned according to the technical life time in the technology catalogue²⁹. A sharp decrease in generation capacity can be observed in 2024, when old oil shale units are expected to be decommissioned. In most scenarios a sharp increase in installed capacity in 2040 is caused by wind power investments.

Figure 22: Total installed capacities in Estonia for all five scenarios



District heating

Figure 23 shows the heat generation from CHP-s for the district heating areas. The share of district heating from CHP-s is estimated to grow from the present around 40% to around 60% in the future. This change is facilitated by additional biomass CHP-s as well as decreasing heating demand.

Figure 23:
District heating
generation from CHP
in Estonia in the five
scenarios

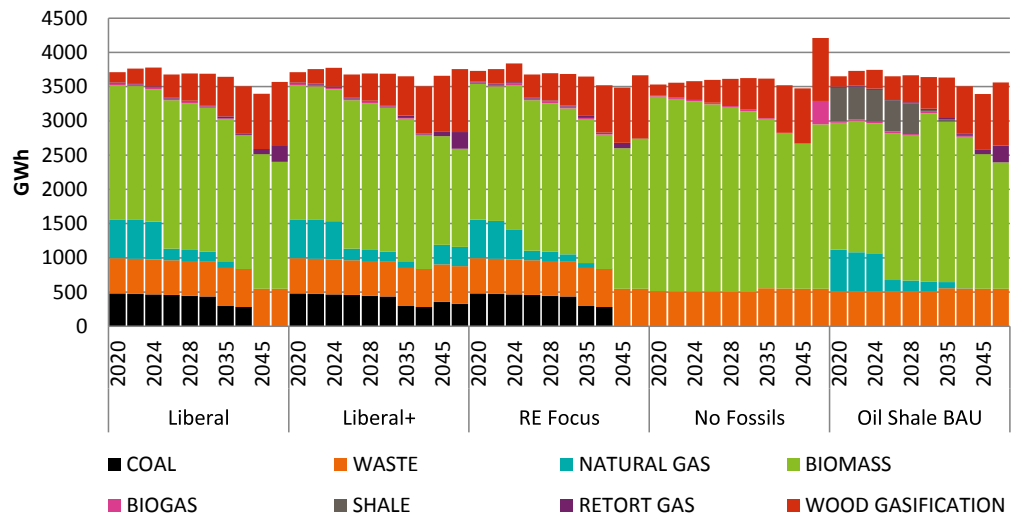

District heating generation from CHP-s is very similar across all studied scenarios. The majority is generated from biomass CHP-s, as biomass is seen to be relatively abundant and cheap local fuel, also immune to CO₂ price changes. The coal based heat generation is specific for Narva, where existing oil shale cogeneration unit is refurbished to burn coal. District heating from burning municipal waste is seen to increase somewhat from present level, due to unused fuel potential. The wood gasification heat generation is seen as a part of nearly zero-energy buildings.

The prognosis for district heating indicates a reduction in total demand. However, the prognosis is uncertain. District heating is the basis for the CHP generation and the possibilities for increasing the demand (e.g. by connecting more buildings) should be studied.

Heat storage

Heat storage is a simple technology that basically is a large hot water steel tank. If it is used efficiently, it can allow the CHP plants to operate when the electricity price is high, even without a heat demand. The storages also allow the CHP plants to reduce the peak demand generation on boilers, since storages can be filled before the demand peaks. The use of heat storage, e.g. in the form of steel tanks is not common in Estonia today. However, the model makes significant investments in heat storages, especially in the RE focus and no fossils scenarios, where there are no cheap options to supply peak load in the long term and the value of moving heat production increases. In the liberal market scenario a total of 20 GWh of heat storage is included during the simulation period, with close to 7 GWh in 2020.

The investment in heat storage seems to be a very robust solution. The investments are very similar in the different scenarios. See Figure 24. The costs of heat storages applied in this study is 210 € per m³ and their efficiency is 95%.

Figure 24:
Cumulative investments
in heat storages in
Estonia (MWh/year)

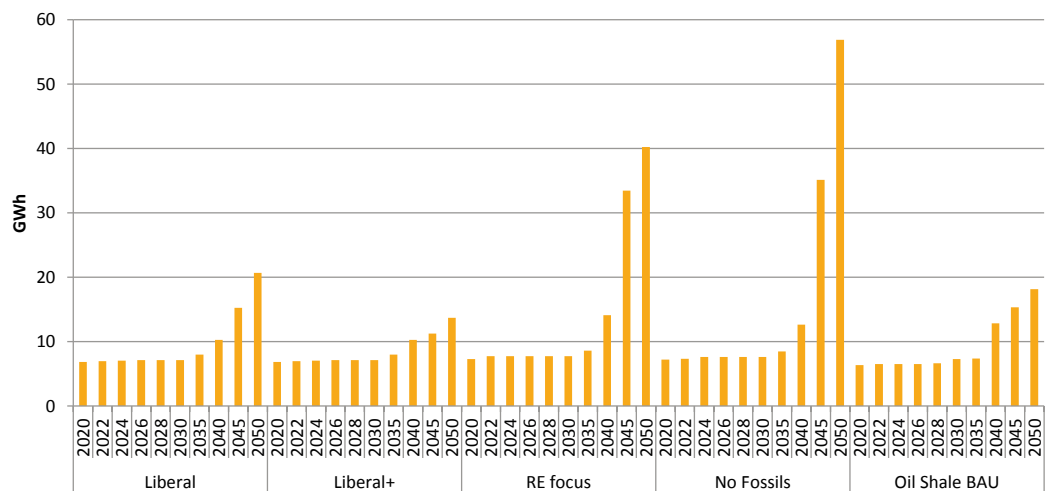

N-1-1 criterion

Figure 25 and Table 5 show how the N-1-1 electricity capacity requirement is met in the liberal+ scenario. It can be seen that the criterion is active only during 2045-2050. The main conclusion is that natural gas generation and some coal capacity will be deployed to meet this requirement in the most cost efficient way. The N-1-1 requirement decreases the development of wind power, since intermittent technologies, e.g. wind, do not count towards meeting this requirement.

Figure 25:
Illustration of how the N-1-1 requirement is met in the liberal+ scenario

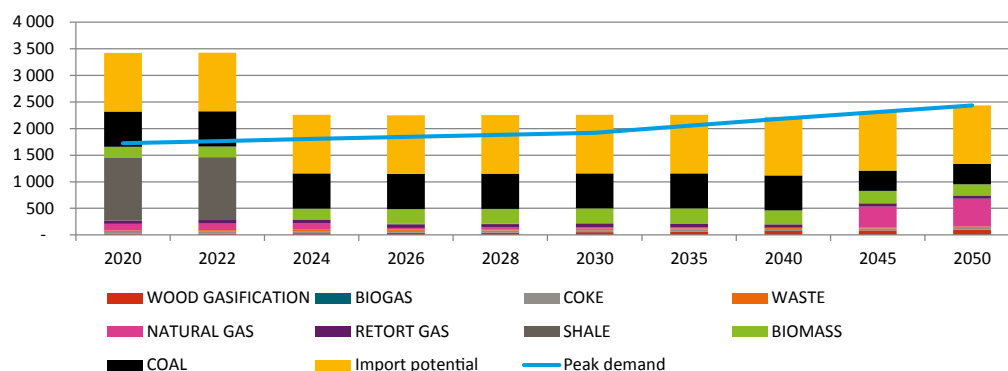

Table 5:
Extra investments due to the N-1-1 requirement. The table shows the difference in investment between the liberal+ and the liberal market scenarios in MW

Year	Goal	Natural Gas	Wind	Biomass
2045	106,5	387,3	-181,7	-31,5
2050	0	135,1	0	39,6
Total	106,5	522,4	-181,7	8,1

Coal attractive in Estonia

Coal prices and relatively low rebuilding cost³⁰ make coal based power generation attractive in many of the scenarios in Estonia. In three scenarios, coal is replacing oil shale. This is done by rebuilding the three newest oil shale units (Eesti PP block 8, Balti PP block 11 and Auvere PP) to coal. This takes place in 2020 – the first year where investments are possible. Only the three newest and most efficient oil shale units can be rebuilt to coal. Rebuilding a power plant is less costly than building a new power plant. Since the plants retain their relatively low efficiency, new coal power plants would be more competitive than these units³¹.

The use of coal continues until 2030. From 2030 to 2050 the increasing CO₂ prices are reducing the use of coal. In general the result is increased import of electricity to Estonia.

Electricity price

Figure 26 shows the Estonian yearly average wholesale electricity prices for all scenarios. There is little variation in the prices across the scenarios for Estonia. Typical values throughout the simulation period are 65-75 €/MWh. The hourly wholesale prices throughout the year are expected to be quite volatile.

Even presently, electricity prices are arguably the most volatile commodity prices. This is seen to be further amplified by intermittent energy sources and reaching lower surplus capacity levels. With less surplus capacity, the prices at demand peaks must support the investments of peaking units, which operate only few hours every year. These, economically efficient peak prices, can be an order of magnitude, or two, higher than the yearly average prices. A highly fluctuating price can be an inconvenience for the market participants as well as unacceptable politically.

30
31

Capital costs of rebuilding existing oil shale plants to coal is set to 5% of a new power plant or approximately 100 000 EUR/MW_e. The rebuilt oil shale power plants have a condensing efficiency of maximum 39% while new coal power plants have an efficiency of up to 46%

Figure 26:
Estonian yearly average
wholesale electricity
prices in all scenarios
(real prices EUR2011)

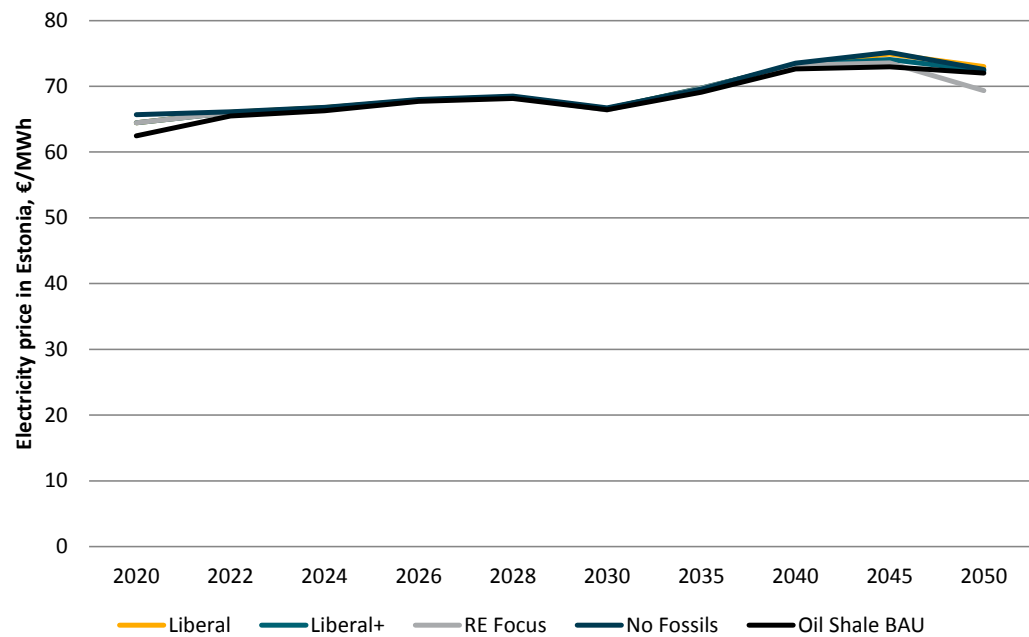

It is also apparent, that the electricity prices increase relatively little between 2020 and 2050. This is despite the increase in CO₂ and fuel prices. It indicates a movement towards renewable energy sources, with low marginal costs. The price is kept at the shown level by the need for new investments and high peak prices in the end of the period.

5.3 ECONOMIC RESULTS

In this section the socio-economic welfare for the stakeholders is shown as the net present value (NPV) over the entire simulation period. Discount rate is 5% and the base year is 2012.

Guide to the economic tables

- *The tables compare the scenarios against the liberal market scenario. Therefore, the value of the difference is given in each category. The values are in millions of euro of net present value with discount rate of 5%.*
- *The consumer surplus is easy to interpret when the energy demand is kept constant. In this case the value is simply a result of a change in the energy price.*
- *Generator profit illustrates the operating profit of the power plants in a specific country. This includes the revenue from electricity and heat sales, variable costs (fuel, CO₂, etc.) and fixed costs (fixed operating costs and capital costs).*
- *When the values for generators and consumers are practically equal, but with different signs, it is typically due to the impact of a changed electricity price. E.g. see the values for the Nordic area and for Germany/Poland in the top part of Table 7. If there are differences between the two values it is because of an altered generation.*
- *The TSO profit is the change in congestion rents (when price difference exists between price areas). The TSO profit includes two components: Congestion rents are included as an income. The congestion rents are the price difference in price times the flow over congested lines. Investments in new transmission lines are included as costs.*

Liberal+ scenario

Table 6 shows the economy of the liberal+ scenario, which means having an Estonian N-1-1 requirement. Only the difference relative to the liberal market scenario is shown. For the entire model area the N-1-1 requirement costs 6 M€ in NPV. For Estonia the total cost is 52 M€. The extra local capacity tends to result in lower prices, which is a benefit for consumers.

As described in previous chapters, the N-1-1 criterion is active only in 2045 and 2050. Therefore, the change in the socio-economic welfare illustrated in the table below, is accumulated during that period. This has an impact on the relative size of the net present value. For example, 5 euro investment in 2045 is discounted to 1 euro in the net present value due to the discount rate of 5% used in the NPV calculations.

For the generators the total loss of 52 M€ (net present value) consist of extra investments and fixed costs of 31 M€, and 21 M€ in reduced operating profit (extra fuel and CO₂ costs minus extra revenues). If assumed that the generators would require a subsidy of 52 M€, this would correspond to 0,7 €/MWh collected from all Estonian electricity demand in the period of 2045 to 2050³² in NPV.

Table 6:
Economic consequences
of the liberal+ scenario
compared to the liberal
market scenario
(NPV 2012)

(Mio. euro)	ESTONIA	LATVIA	LITHUANIA	RUSSIA	NORDIC	GERMANY & POLAND	TOTAL
Generator profits	-52	2	2	4	6	-28	-67
Consumer surplus	10	-2	-2	-6	22	76	97
TSO profit	-9	9	13	-3	-50	4	-36
Socio economic benefit	-52	9	13	-5	-22	51	-6

The total undiscounted costs of the N-1-1 requirement have been calculated to approximately 280 M€ for Estonia and approximately 200 M€ for the whole model area.

RE focus scenario

Table 7 presents the social welfare results for the RE focus scenario compared to the liberal market scenario. As illustrated on the Figure 21, the renewable energy constraint in this scenario results in more wind power development as well as more evenly distributed investments across the years. The added row of Public profit illustrates the required subsidy for the generators in order to fulfil the RE constraint. The subsidy is calculated from the marginal cost of the last required MWh of renewable energy. Then, all renewable energy is assigned this marginal cost as a subsidy.

Table 7:
Economic consequences
of the RE focus scenario
compared to the liberal
market scenario
(NPV 2012)

(Mio. euro)	ESTONIA	LATVIA	LITHUANIA	RUSSIA	NORDIC	GERMANY & POLAND	TOTAL
Generator profits	-26	-30	3	-29	-90	-71	-243
Consumer surplus	50	43	-1	31	90	76	289
TSO profit	-1	3	-1	4	-30	10	-15
Public profit	-70	0	0	0	0	0	-70
Socio economic benefit	-48	16	2	5	-30	15	-39

When the renewable energy target in Estonia is applied, there will be an extra cost for the entire system. The RE requirement in Estonia will also change the investment pattern in the other countries in the system. Additional RE investments will normally increase the capital costs and decrease consumer prices, while the balance between these is decided by the interest rate.

The renewable energy constraint amounts to Estonian costs of 48 M€ and the whole modelling area costs of 39 M€. It is apparent, that the constraint brings additional costs (or loss of revenue) for the generators and benefits to the consumers via lower electricity prices. This, however, is not true for Lithuania, which sees little change in distribution of welfare. The RE constraint has the effect of bringing some of the wind investments from Lithuania to Estonia.

The total wind power investments in Baltic States increase less than the investments in Estonia. Therefore, some intended investments in Latvia and Lithuania are lured to Estonia, due to the RE requirement. This also explains the relatively small required subsidy to achieve the RE scenario. The subsidy is 70 M€ in NPV or 0,2 €/MWh on demand in the period of 2020-2050. Majority of this subsidy is required in the end of the period and is therefore heavily discounted in the NPV calculations. The undiscounted subsidy would be 373 M€.

32

The subsidy level of 0,7 €/MWh is calculated dividing the NPV value of 52 M€ for generators with all Estonian electricity demand in the period from 2045 to 2050

Oil shale BAU scenario

Table 8 shows the socioeconomic results for oil shale BAU scenario compared to the liberal market scenario. For the oil shale BAU scenario the cost of the retort gas is anticipated to be zero, as it is an oil production by-product with no added costs³³. Also, cheap oil shale is available for electricity production for a longer period. As expected the scenario results in significant profit for the Estonian generators. Since the use of retort gas has major economic implications, the utilisation of retort gas in heat and power sector, or other sectors, should be further analysed.

The oil shale BAU scenario assumes an increasing use of retort gas from 2 PJ in 2012 to 26 PJ in 2020 and 44 PJ in 2030. As the fuel is assumed to be free of cost, the marginal cost of the electricity from retort gas is expected to comprise mostly of CO₂ quota price. With emissions similar to natural gas, this means low cost electricity compared to the market price and leads to high profits for Estonian generators. For all other countries, the scenario means some reduction in electricity prices and therefore lower profits for the generators and higher surpluses for the consumers.

Table 8:
Economic consequences of the oil shale BAU scenario compared to the liberal market scenario (NPV 2012)

(Mio. euro)	ESTONIA	LATVIA	LITHUANIA	RUSSIA	NORDIC	GERMANY & POLAND	TOTAL
Generator profits	3425	-80	-99	-289	-1957	-182	817
Consumer surplus	155	109	126	242	2080	201	2913
TSO profit	0	40	9	28	-70	46	53
Socio economic benefit	3581	68	36	-19	53	65	3783

No fossils scenario

Table 9 shows the socioeconomic results for the no fossils scenario compared to the liberal scenario. In the no fossils scenario all fossil fuels are prohibited in Estonia. This means that existing fossil fuel based production units must now either rebuild to a renewable fuel or decommission. Renewable fuels tend to be more expensive than the fossil fuels. This leads to a significant loss for the power producers in Estonia, compared to the liberal scenario (see Table 9). It also leads to a little higher electricity prices for the consumers.

Table 9:
Economic consequences of the no fossils scenario compared to the liberal market scenario (NPV 2012)

(Mio. euro)	ESTONIA	LATVIA	LITHUANIA	RUSSIA	NORDIC	GERMANY & POLAND	TOTAL
Generator profits	-1060	82	144	-170	1356	45	396
Consumer surplus	-75	-76	-104	217	-1342	69	-1310
TSO profit	-8	-18	-59	-35	-41	-29	-191
Socio economic benefit	-1143	-12	-19	12	-27	84	-1105

Profitability of investments

BALMOREL is myopic in its investment approach, which means that it does not consider revenues beyond the year of installation. Investments are undertaken in a given year if the annual revenue requirement³⁴ in that year is satisfied by the market. This also means that the investments are not necessarily profitable beyond the year of installation. To check the investments carried out in Estonia it has been analysed if the investments are also profitable in the long term with an interest rate of 5%. Included in this analysis are fixed and variable O&M, fuel, CO₂ and capital costs as well as district heating and electricity sales.

The analysis indicated that all investments in biomass CHPs are profitable in all years of operation. Wind power is also profitable. The rebuilding of the Narva oil shale plants to coal is generally profitable. However, especially the Auvere unit generates this profit, while Narva 8 and 11 are only profitable in the first 5-10 years of operation. Figure 27 illustrates the profitability of Estonian generators, divided by fuel type.

33 Investment costs for the retort gas power plants is set to 0,6 M€/MW. About 600 MW of new retort gas units are built, which corresponds to investment cost of 360 M€
34 See Chapter 4 for further description of the investment approach

Figure 27:
Costs and profits for
Estonian electricity
and district heating
generators in 2020,
2030 and 2050 in the
liberal market scenario
(M€/year). Capital costs
are calculated with an
interested rate of 5 % and
20 years payback time

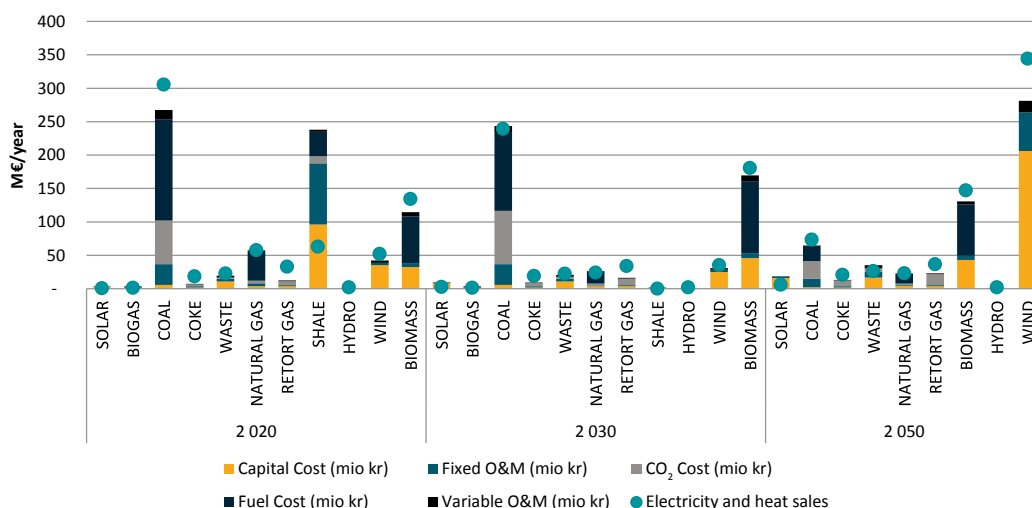

As stated under the methodology, the model invests under the assumptions of 10% internal return for 20 years, or 11,7% annual return on the capital investment. This is a higher investor return rate compared to the social interest rate used in the NPV calculations. The Balmorel model is an economic equilibrium model. This means it invests in a technology until it is profitable, unless some barrier for entry exists. Consequently, the generator profits in every year converge to zero, if investments are profitable, or are negative, if conditions for certain previously made investment have worsened.

From the perspective of international competitiveness, it can be observed that Estonia is in deficit in most of the scenarios. Despite the deficit, some competitive advantages for Estonian electricity generation can be identified. First, there is significant local biomass resource in addition to district heating demand, which allows for biomass CHP-s.

Secondly, Estonia has good wind conditions. Although no wind investments are present in the liberal scenario for 2020-2030, there are significant investments in Lithuania and Latvia. As indicated by RE focus scenario, very small subsidy is required to have wind investments in Estonia instead of Latvia and Lithuania.

Thirdly, the existing oil shale fuelled units can be refurbished to burn coal with small capital costs. This allows flexibility in fuel choice and potentially significantly enhanced working hours for the existing infrastructure.

Fourth, in case of the planned development in the shale oil production, there is significant retort gas resource which could be used for electricity production. This retort gas electricity is estimated to be with low marginal cost and could significantly improve the Estonian electricity balance and lead to electricity exports.

5.4 SENSITIVITY ANALYSIS

The figures below illustrate the results of a set of simple sensitivity analyses. The simulations have been fixed in 2030 and for this year a number of parameter variations are made. No new investments are allowed in these simulations. The parameters are changed for the entire model area except for consumption, which is changed for Estonia. The investments until 2030 are fixed. The impact of these variations on CO₂ emissions and electricity generation in Estonia is analysed. The results are given for the liberal scenario.

The table below shows the steps of the parameter variations while Figure 28 and Figure 29 show the results of the analyses.

Table 10:
The different steps in the parameter variations.
"+25%" does for example indicate the parameter is increased by 25%

	Biomass/natural gas/coal/CO₂	Demand
Step 1	-50%	-25%
Step 2	-37,5%	-18,75%
Step 3	-25%	-12,5%
Step 4	-12,5%	-6,25%
Base	0%	0%
Step 5	+12,5%	+6,25%
Step 6	+25%	+12,5%
Step 7	+37,5%	+18,75%
Step 8	+50%	+25%

The CO₂ emissions (Figure 28) as well as electricity production (Figure 29) are most sensitive to gas and coal price changes. Regarding the gas price, the electricity system is most sensitive to the price reductions. The gas price reduction reduces emissions and generation in Estonia, as there is little gas powered capacity in Estonia. Gas capacities in other countries make Estonian coal power less competitive. Gas price increase improves coal competitiveness and hence generation, but the influence is limited to the installed coal capacity in Estonia.

Coal price changes have the opposite effect to the gas price changes. Increase in coal price reduces the generation, while decrease in prices improves the generation. It is important to note that the sensitivity often is not proportional to the price changes. For example, the generation, and emissions, from coal decrease more than 50% from a coal price increase of 50%. These nonlinear responses to changes are important for policy-making. Another example of this can be observed from the sensitivity for CO₂ price. At a certain CO₂ price, there is a sudden jump (step 3) in coal power production. This implies that there is a price for CO₂, where coal power becomes suddenly more competitive than a significant portion of some other generation source. For the case in hand, Estonian coal power plants become cheaper than a share of gas combined cycle power plants in other countries.

The sensitivity analysis for biomass reveals that increase in biomass prices decreases the generation from biomass, however, it increases the total electricity production in Estonia. This is possible due to interconnected regional market, where reduced competitiveness of biomass improves the economics for coal power.

The sensitivity for demand illustrates, that the local generation reacts linearly to the change in consumption. However, the change in generation is nowhere close to the change in demand. It is clear from this that on a regional power market, the change in demand and production can be geographically separated.

Figure 28:
Estonian CO₂ emission
in 2030 when fuel and
CO₂ prices are de- and
increased. Liberal
scenario. "Base" indicates
no change in parameter
variation and is therefore
the same in all variations

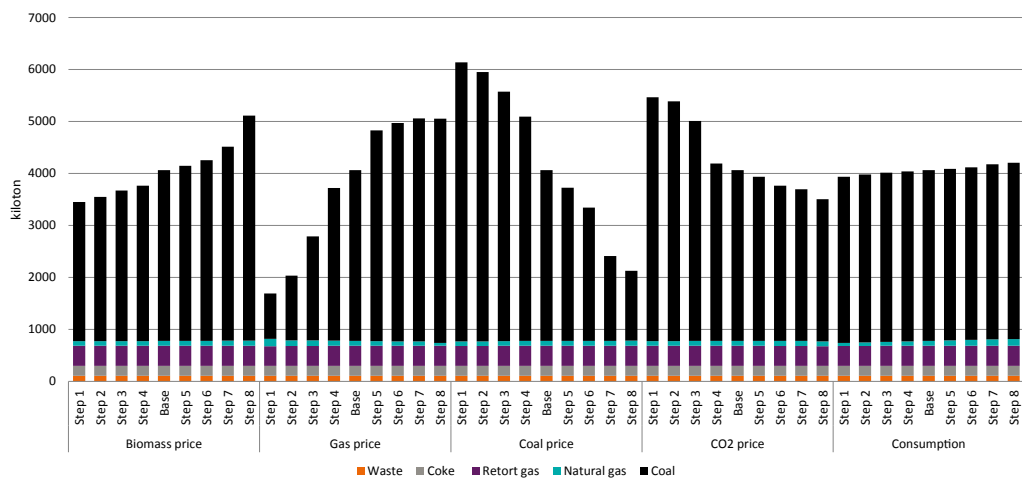
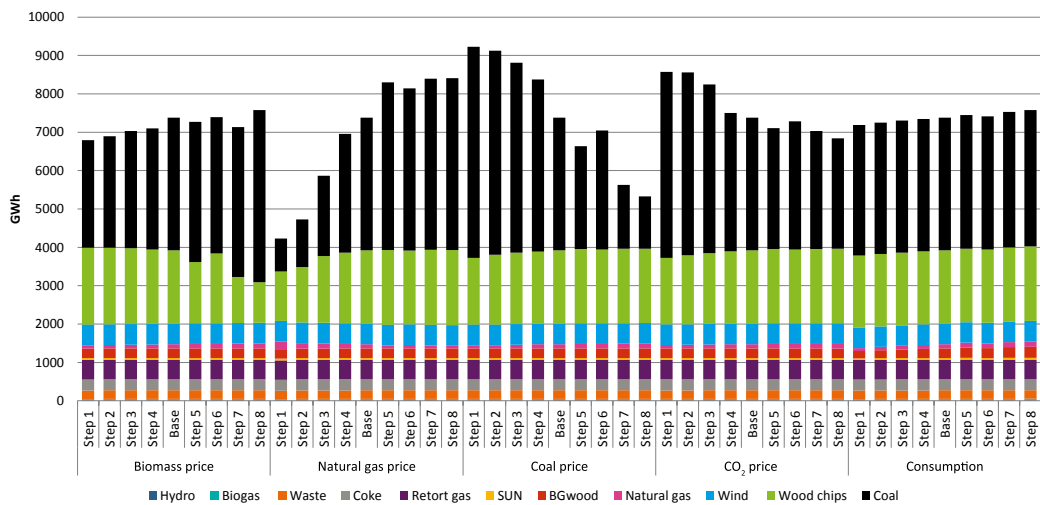

Figure 29:
Estonian electricity
generation in 2030 when
fuel and CO₂ prices as well
as demand are changed.
Liberal scenario.
"Base" indicates no
change in parameter
variation and is therefore
the same in all variations



Infrastructure

The different scenarios presented in this study require different levels of energy infrastructure upgrades. This is related to several aspects of infrastructure, e.g. electricity grid and transport.

Regarding the upgrade of electricity transmission interconnectors, these are described in the five scenarios of the electricity and district heating system. From this analysis it can be seen that very limited upgrades are needed towards 2030 and 2050. Only the interconnector capacity with Finland is increased in the scenarios.

The development of onshore wind power is generally high in all scenarios. In the liberal market scenario the wind power generation reaches 5,6 TWh and in the RE scenario it is above 11 TWh in 2050. The lowest levels of wind power generation are found in the oil shale BAU scenario with a generation of around 3,6 TWh in 2050. Especially the very high levels of wind power will lead to an increased need for grid upgrades, which will lead to higher costs to enable the transport of wind power from e.g. the coastal regions with good wind resources to the transmission grid. These costs can be divided into shallow and deep connection costs. The shallow costs are solely the connection of the wind turbines to the grid, while the deep connection costs are the costs related to upgrades of the existing grid if this is necessary. The shallow connection costs are included in this study, as these are included in the investment costs of the wind turbines where they make out around 5% of the total capital costs.

The requirement for deep connection costs are not included, and these can be significant, especially if the turbines are located in sparsely populated coastal areas with less developed existing grid. The ENTSO-E EWIS (ENTSO-E, 2007) study concludes that the operational costs associated with wind integration are 2,1 EUR/MWh in their best estimate scenario and 2,6 EUR/MWh in a scenario with high wind penetration.

Consumer affordability

An important aspect for assessing the development scenarios is the end-user affordability. The energy cost for end-users is important, both for households and for companies.

Five scenarios are studied with the Balmorel model, and the price for electricity is computed. The model assumes perfect competition and rational investment behaviour. As a consequence of this the model based investments will counteract high prices by investing in new generation capacity. Therefore, the wholesale price for electricity is not that different in the different scenarios (see Figure 26). Typical values are 65-75 €/MWh. It should be noted that the wholesale electricity prices in the scenarios are significantly higher than the current market prices on Nord Pool Spot. Compared to the current electricity market price of around 45 €/MWh, the price in the scenarios is expected to increase by more than 40 %, which is a significant increase.

The wholesale price is found as the marginal price for generating electricity. For the end-user, grid tariffs and taxes should be added to find the total costs. The subsidies needed in some of the scenarios (e.g. the liberal+ and the RE focus scenarios) could be collected with a tariff. In this case the subsidy value must be added to the end-user price.

Electricity and heating costs are two important elements in the energy bill of a household. It has been analysed how electricity and heating costs will develop over time compared to the household income. It should be noted that this analysis is carried out without taxes. The analysis shows that the electricity and heating costs are growing at a slower pace than the household income. In this analysis, the household income is assumed to follow the GDP growth prognosis by Estonian Ministry of Finance and EU Economic Policy Committee³⁵. The electricity cost prognosis is based on the present study (see Figure 26) and the heat cost on the district heating study (Estonian Development Fund, 2013). The infrastructure costs are assumed to grow at the same pace as the energy costs. Both, the GDP growth and the energy costs growth are expressed in real terms. Based on the analysis, the energy costs' share in a household budget should be decreasing, assuming the same level of demand per household. In reality, an increase in electricity demand and decrease in heat demand is predicted. The result is illustrated in the Figure 30 below, which shows that the electricity and heat costs growth should be slower from the GDP growth.

Figure 30:
Average GDP growth
compared to the
electricity and heat costs'
growth (2012 = 100)

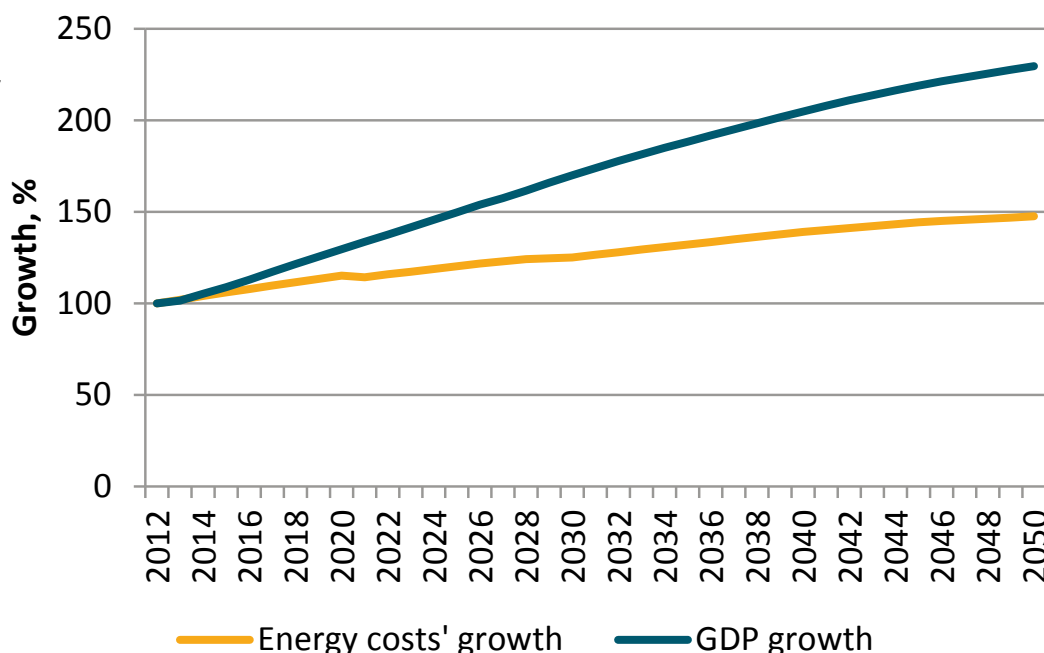

Glossary

AC	Alternating Current
BASREC	Baltic Sea Region Energy Cooperation
BEMIP	Baltic Energy Market Interconnection Plan
CCS	Carbon Capture and Storage
CFB	Circulating fluidized bed
CHP	Combined heat and power
DC	Direct Current
ENMAK	Estonian Energy Strategy (Eesti energiamajanduse arengukava)
ENTSO-E	European Network of Transmission System Operators for Electricity
ETS	Emissions Trading Scheme
EU	European Union
EUSBSR	European Union Strategy for the Baltic Sea Region
EWIS	European Wind Integration Study
GDP	Gross Domestic Product
GHG	Greenhouse Gas
IEA	International Energy Agency
IPS/UPS	Russian Unified Power System
LCOE	Levelised Cost of Energy
LNG	Liquefied Natural Gas
NPV	Net Present Value
NREAP	National Renewable Energy Action Plan
O&M	Operation and Maintenance
OPEC	Organization of the Petroleum Exporting Countries
OPEX	Operational Expenditure
PV	Photovoltaic
RE	Renewable Energy
UBC	Union of the Baltic Cities
WEO	World Energy Outlook

References

BASREC (2012): Conditions for deployment of wind power in the Baltic Sea Region. Analysis part I. Enabling studies.

Brückmann, R., R. Piria, J. Herling, D. Bauknecht (2011): Integration of electricity from renewables to the electricity grid and to the electricity market – RES integration. National report: Estonia. Client: DG Energy.

Bundgaard, S. S., M. Togeby, K. Dyhr-Mikkelsen, T. Sommer, V. H. Kjærbye, A. E. Larsen (2013, a): Spending to save: Evaluation of the energy efficiency obligation in Denmark. ECEEE 2013.

Bundgaard, S. S., K. Dyhr-Mikkelsen, A. E. Larsen, M. Togeby (2013, b): Energy efficiency obligation schemes in the EU – lessons learned from Denmark.

CDC Climate research (2013): Auction revenues in EU ETS Phase 3: A new public resource.

Danish Energy Agency and Energinet.dk (2012): Volume 1: Individual heating plants and energy transport. Volume 2: Generation of electricity and district heating, energy storage and energy carrier generation and conversion. Technology data for energy plants, May 2012.

Ea Energy Analyses (2010): Wind Power in Estonia. An analysis of the possibilities and limitations for wind power capacity in Estonia within the next 10 years.

Ea Energy Analyses (2012): Energy policy strategies of the Baltic Sea Region for the post-Kyoto period. Main report, data and cost of interconnectors in the BSR report.

Ea Energy Analyses (2013): Long-term energy scenarios for Estonia.

Elering (2013a): Annual report 2012.

Elering (2013b): Eesti Elektrisüsteemi Varustuskindluse Aruanne 2013.

ENTSO-E (2007): European Wind Integration Study (EWIS)

ENTSO-E (2012): Scenario Outlook and Adequacy Forecast 2012-2030.

Estonian Development Fund (2013a): Kaugkütte energiasääst.
http://www.energiatalgud.ee/img_auth.php/4/46/Eesti_Arengufond._Kaugk%C3%BCtte_energias%C3%A4%C3%A4st.pdf

Estonian Development Fund (2013b): Energy resources of Estonia.

EU Energy Roadmap 2050: COM(2011) 885 final of 15 December 2011. ISBN 978-92-79-21798-2.

Eurostat (2013a): Eurostat database: 'Energy statistics'.
epp.eurostat.ec.europa.eu/portal/page/portal/statistics/search_database

Eurostat (2013b): Eurostat database: 'Concepts and definitions'.
epp.eurostat.ec.europa.eu/portal/page/portal/statistics/search_database

European Academies (2007): A study on the EU oil shale industry – viewed in the light of the Estonian experience. A report by EASAC to the Committee on Industry, Research and Energy of the European Parliament. Science Advisory Council.

European Commission (2010): Analysis of options to move beyond 20% greenhouse gas emission reductions and assessing the risk of carbon leakage. Commission staff working document accompanying the Communication from the commission to the European Parliament, the Council, the European Economic and Social Committee and the committee of the regions. Background information and analysis. Part II. COM (2010) 265 final.

European Commission (2011): Energy Roadmap 2050. COM(2011) 885 final.

European Commission (2012): Directive 2012/27/EU of the European Parliament and of the Council of 25 October 2012 on energy efficiency, amending Directives 2009/125/EC and 2010/30/EU and repealing Directives 2004/8/EC and 2006/32/EC. Official Journal of the European Union, L315.

European Commission (2013a): Green paper: A 2030 framework for climate and energy policy. 27.3.2013. COM (2013), 169 Final.

European Commission (2013b): Action plan for the European Union Strategy for the Baltic Sea Region.

European Commission (2014): A policy framework for climate and energy in the period from 2020 to 2030. COM(2014) 15.

European Commission and Russian Ministry of Energy (2011): Roadmap of the EU-Russia Energy Cooperation until 2050 - Progress report. *http://ec.europa.eu/energy/international/russia/press_en.htm*

IEA (2013): World Energy Outlook 2013.

Jüssi, M., et al. (2013): Energiasäästupotentsiaal Eesti transpordis ja liikuvuses.

Kisel, E. (2011): Carbon leakage in electricity market– how to ensure fair competition? Deputy Secretary General for Energy Ministry of Economic Affairs and Communications of Estonia.

Korppoo, A., G. Sakonov, O. Lugowoy (2010): Russia and the post 2012 climate regime. Emission trends, commitments and bargains. Nordic Council of Ministers.

Kuhi-Thalfeldt, R, A. Kuhi-Thalfeldt, and J. Valtin (2010): Estonia electricity production scenarios and their CO₂ and SO₂ emissions until 2030.

Kurnitski, et al. (2013): Eesti energiamajanduse arengukava ENMAKi uuendamise hoonete energiasäästupotentsiaali uuring. *http://www.energiatalgud.ee/img_auth.php/c/c1/ENMAK-Hoonete-uuring-20.09.2013.pdf*

Ministry of Economic Affairs and Communications (2010): National Renewable Energy Action Plan (NREAP). *http://ec.europa.eu/energy/renewables/action_plan_en.htm*

Appendix A: Long-term energy scenarios for Estonia – Summary of results

Below a short summary is given of the results from the study “Long-term energy scenarios for Estonia” by Ea Energy Analyses. The study by Ea Energy Analyses preceded the study presented in this report and was the basis for choosing the scenarios. Please note that several input assumptions have changed from the first study to the second one, which has caused some changes in the results.

THE SCENARIOS

In dialogue with the steering group and expert groups a number of topics have been identified that are of importance to the formulation of an Estonian long-term vision and strategy for the energy sector development. These are:

- The weight given to combat climate change,
- A rule to secure local electricity generation capacity in Estonia,
- National policy on the share of renewable energy in Estonia,
- The continued use of shale oil for electricity generation and
- The threat of carbon leakage to Russia.

Eight scenarios have been set up to analyse these topics. None of these individual scenarios is meant to predict the future. The scenarios are only intended to show the consequences of different potential developments. The energy demand is assumed to develop in the same manner for all supply scenarios except the renewable energy focus scenario and the CO₂ concern scenario, where higher energy efficiency improvements are assumed.

Figure 31:
The eight modelled single track scenarios

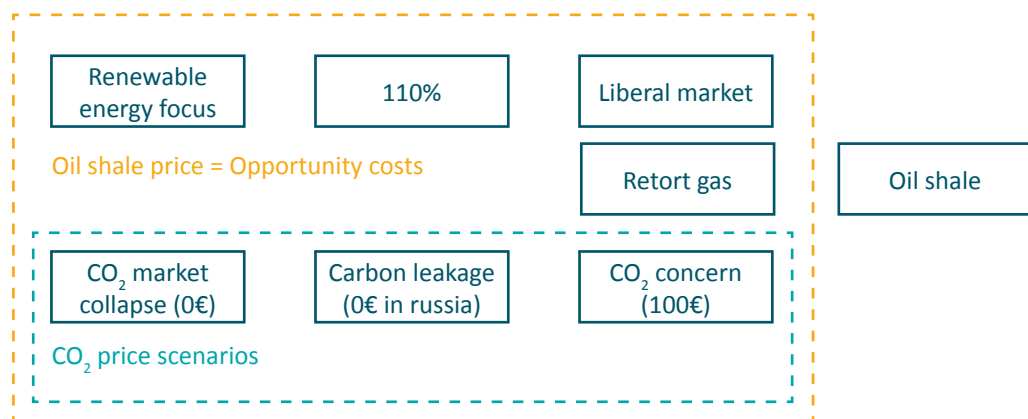

Security of supply (110%)

In the 110% scenario the electricity generation capacity in Estonia is required to be 110% of the maximum hourly peak electricity demand in any given year. Intermittent generation, such as wind and solar, are not counted towards the 110% requirement. Also, reserves and transmission lines are not counted. No similar requirements are made for the other countries in the model area.

Liberal market

The liberal market scenario is similar to the 110% scenario except that the 110% requirement for Estonia is not activated.

National RE focus

The renewable energy scenario is equal to the liberal market scenario, except national targets are set for the generation of heat and electricity based on renewable energy in Estonia in 2030 (50% RE of electricity and district heating demand) and 2050 (100% RE of electricity and district heating demand). In this scenario a lower energy demand is assumed resulting from energy efficiency improvements.

No new investments in fossil fuelled technologies are allowed in Estonia in this scenario, except existing oil shale power plants can be rebuilt to use coal.

Oil shale

The oil shale scenario is similar to the liberal market scenario, except that 7 Mt of oil shale (approx. 41 PJ fuel) is available at mining costs. This scenario can be understood as the case where the capacity of producing shale oil is limited to the currently decided refining capacity, which means the substitution price is not relevant.

Retort gas

In the retort gas scenario shale oil is produced instead of diesel on the refineries. In this process retort gas is a by-product and this gas can be utilised for e.g. electricity generation.

It is assumed that three units producing shale oil are commissioned by 2020 and in the period from 2020 to 2030 one unit comes online every second year giving a total of eight units by 2030. The entire oil shale resource of 20 Mt/year is utilised by these refineries in 2030 and each unit will be equipped with a gas motor utilising the retort gas with an electricity capacity of 90 MW. In 2030 the total electricity capacity of these eight units combined will be 720 MW. These units are assumed to run continually and the retort gas resource is assumed to have a cost of zero. In addition the assumptions from the liberal market scenario are used in this scenario.

CO₂ price scenarios

Two scenarios are used to describe variation in the CO₂ price. In the CO₂ market collapse scenario the CO₂ price is set to zero, while in the CO₂ concern scenario the CO₂ price is set to a value corresponding to the IEA's 450 scenario (from WEO 2012), reaching 34, 73 and 92 €/ton CO₂ in 2020, 2030 and 2035, respectively. The price in 2050 is set to 100 €/ton CO₂. Furthermore, in the CO₂ concern scenario a lower energy demand is assumed resulting from energy efficiency improvements.

Carbon leakage

In all scenarios except the carbon leakage scenario it is assumed that measures are in place, so that no CO₂ leakage takes place in relation to cross border electricity trade with Russia. This is modelled by assuming the same CO₂ price in Russia as in the EU. In the carbon leakage scenario a zero CO₂ price is used for Russia³⁶.

It should be noted that the current CO₂ price (7th June 2013) is 4 €/ton. This is much closer to the CO₂ price collapse scenario than to IEA's New Policy scenario (used in six of the eight scenarios).

An overview of the central parameters for each scenario can be found in the table below.

Table 11:
Central parameters for the scenarios. The two scenarios with reduced energy demand will be computed in two steps: with and without the reduced energy demand. In this way the impact of each step can be found
* Zero in Russia.
** Of electricity and heat demand

Name of scenario	Estonian energy demand	Estonian capacity constraint	Estonian RE generation 2030 / 2050	CO ₂ price EUR/ton 2020 / 2030 / 2050	Oil shale price after 2020
110%	BAU	110%	-	23 / 30 / 47	Substitution
Liberal market	BAU	-	-	23 / 30 / 47	Substitution
Oil shale	BAU	-	-	23 / 30 / 47	Mining costs for max 7Mt
Retort gas	BAU	-	-	23 / 30 / 47	Substitution. Retort gas is used for electricity generation
National renewable energy focus	EE	-	50% / 100% **	23 / 30 / 47	Substitution
CO ₂ market collapse	BAU	110%	-	0 / 0 / 0	Substitution
Carbon leakage	BAU	110%	-	23 (0*) / 30(0*) / 47(0*)	Substitution
CO ₂ concern	EE	110%	-	34 / 73 / 100	Substitution

THE RESULTS

Figure 32 illustrates the fuel-mix in electricity generation in 2030 in the liberal scenario. The volume of coal is decreasing and wind power is increasing as the CO₂ price is increasing in the three scenarios with zero, medium and high CO₂ price (see Figure 33). In the CO₂ concern scenario, natural gas acts as an important bridging technology from coal to renewable and CCS.

Figure 32:
Electricity generation in the model area in three scenarios with low, medium and high CO₂ price. Please note for this and the following figures: The time scale starts with 2012 and then 2020. After 2020 it shows two years steps until 2030 and 5 years steps thereafter

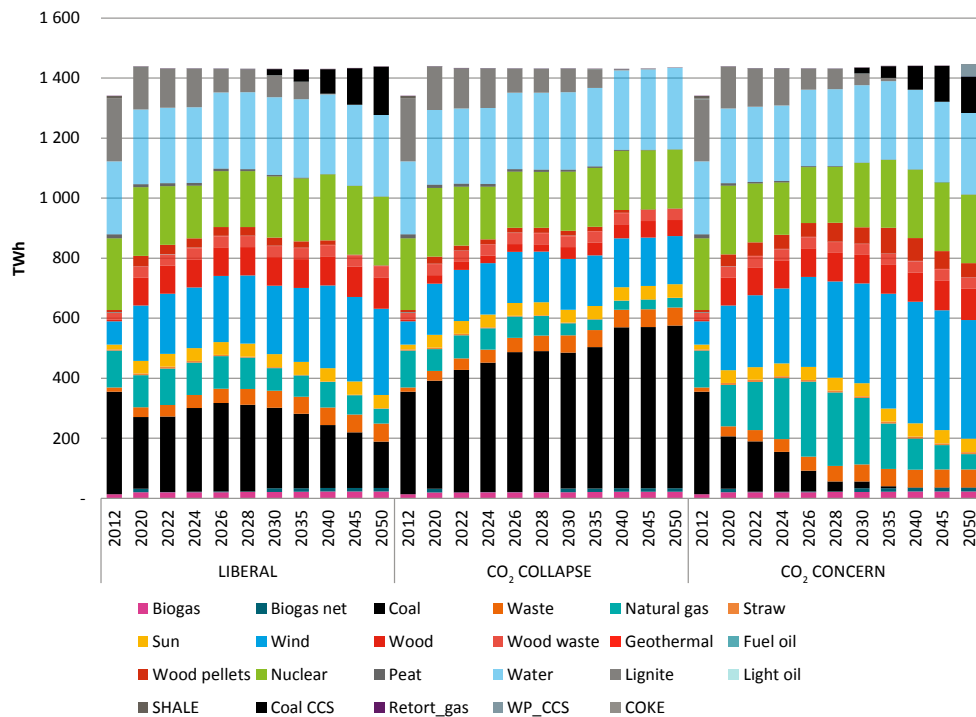
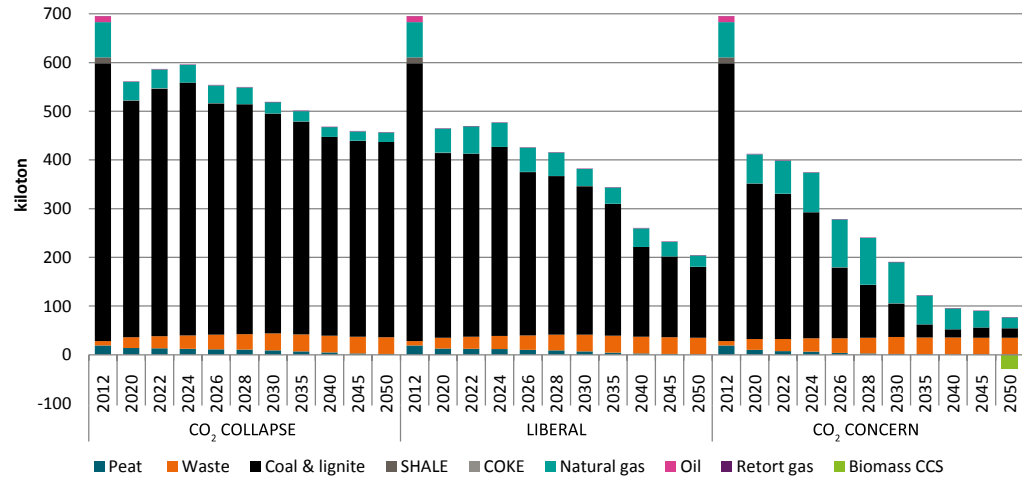

Table 12:
MW investment in wind power in three scenarios with low, medium and high CO₂ price

MW	2020	2022-2030
CO ₂ collapse	24,100	2,600
Liberal	27,700	16,500
CO ₂ concern	37,800	36,400

The expansion of wind power is dependent on the CO₂ price (see Table 12). In the period 2022- 2030 the investments in wind power are increased by a factor 14, when comparing the CO₂ collapse and the CO₂ concern scenarios. In the CO₂ concern scenario the investments in wind take a step up in 2026 – the year where the model is allowed to invest in new transmission lines.

Figure 33:
CO₂ emissions in model area in three scenarios with low, medium and high CO₂ price



The resulting CO₂ emissions in the model area start at 700 Mt in 2012, and is reduced to 200 Mt in 2050 in the liberal scenario. In the CO₂ collapse scenario the emission is also reduced, but only to 450 Mt. In the CO₂ concern scenario the emission is reduced to 50 Mt in 2050.

EU Road maps for 2050 take the starting point on limiting the atmospheric warming to 2°C. This translates into 80-95% reduction of greenhouse gasses by 2050 compared to 1990³⁷. The electricity and district heating sectors are expected to be almost CO₂ neutral in this road map. It is only the CO₂ concern scenario (with a 100 €/t CO₂ price in 2050) that follows such a development.

Results - Estonia

Electricity generation in Estonia can be seen in Figure 34. In all scenarios (except the oil shale scenario) the use of oil shale is minimised in 2020 and thereafter. Coal and wood chips are introduced to replace the oil shale.

In the liberal scenario wind power increases from 10% of local generation in 2020 to 32% in 2030 and 61% in 2050. The model is only investing in onshore wind power. The wind power capacities are 313 MW, 987 MW and 1,710 MW in 2020, 2030 and 2050, respectively. In a previous wind power study (Ea Energy Analyses, 2010) similar amounts of wind power have been studied and the results indicate that some curtailment must take place, e.g. 1% with 1,000 MW. However, this result is for 2020. The additional interconnectors in 2050 will help integrate the large amount of wind power. Please see Figure 34.

Figure 34:
Electricity generation
in Estonia in the eight
scenarios

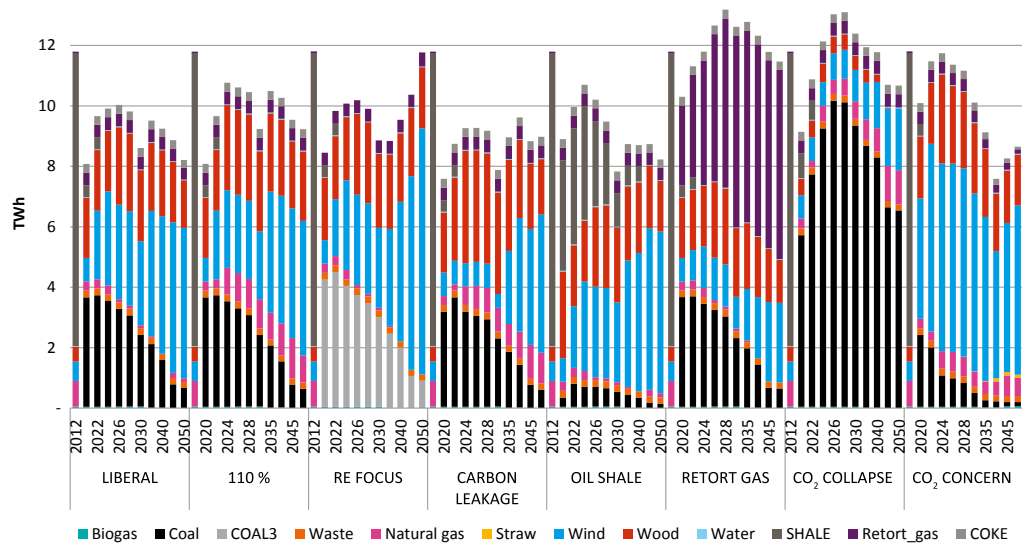

CO₂ emissions

The pricing for oil shale in accordance to its substitution price results in reduction of CO₂ emission from the district heating and power sector. See Figure 35. It should be noted that while the use of oil shale is reduced in the electricity and district heating sector, the total oil shale mined may be unchanged (20 Mt/year) because of the increased use of oil shale for producing shale oil. The CO₂ emissions from the shale oil refineries are 3.9 Mt per year in the period from 2020 to 2050.

Figure 35:
Total CO₂ emission
in Estonia in the
eight scenarios

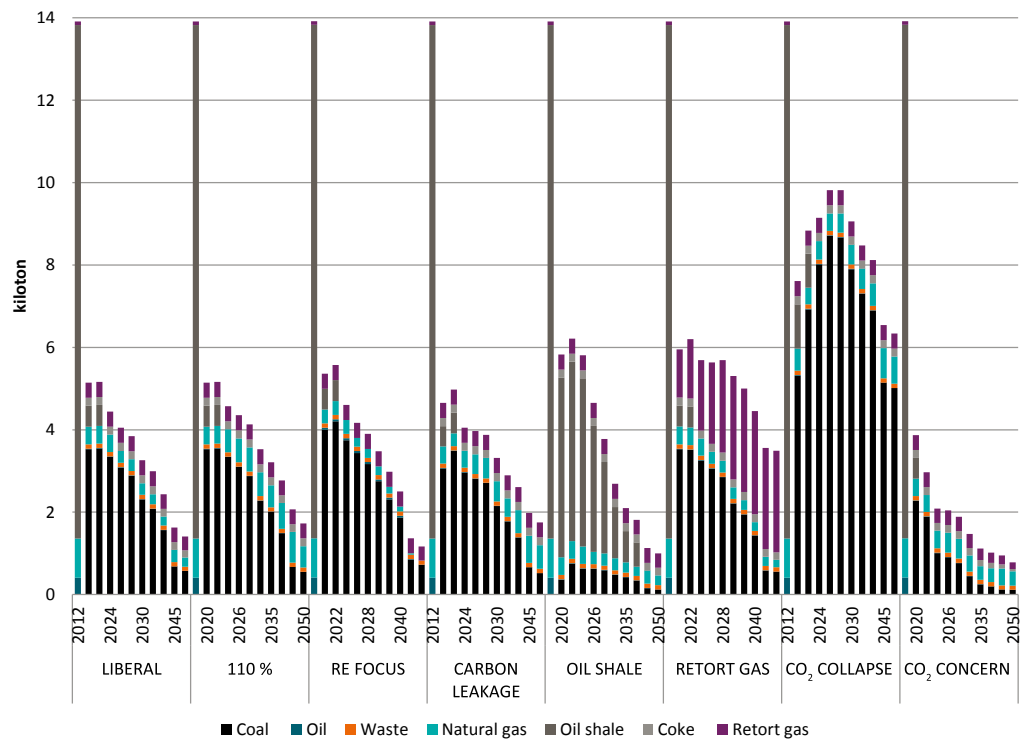

Investments in new generation capacity

The Estonian 2020 renewable energy goals are reached without subsidies in all scenarios except the CO₂ collapse scenario. The goals are reached by commercial investments and operation. Note that this result is simulated under optimal electricity market condition. This also means the power price includes all costs, which in the longer term is long run marginal costs. In the CO₂ collapse scenario a shadow price of 6 €/MWh is needed to reach the renewable energy goal in 2020. The 2020 goal is maintained for the rest of the simulation period at a shadow price of 12,5 €/MWh in 2030 and 10 €/MWh in 2050.

Investment in significant amounts of wind power in Estonia takes place during 2022-2024 (800 MW) and 2035-2045 (1,710 MW).

The 110% rule that secures local capacity to cover Estonian peak electricity consumption has impact from 2024 and forward. Mainly natural gas based turbines are introduced to fulfil the capacity requirement (e.g. 600 MW in 2030). The extra investment in Estonia is reducing investment in other countries. In 2020 and 2022 commercial investment takes place in Estonia - independent of the 110% rule. See Figure 36.

Figure 36: Investment in electricity generation capacity in Estonia. In the Liberal and Retort gas scenarios there are no model investments in 2028 and 2030

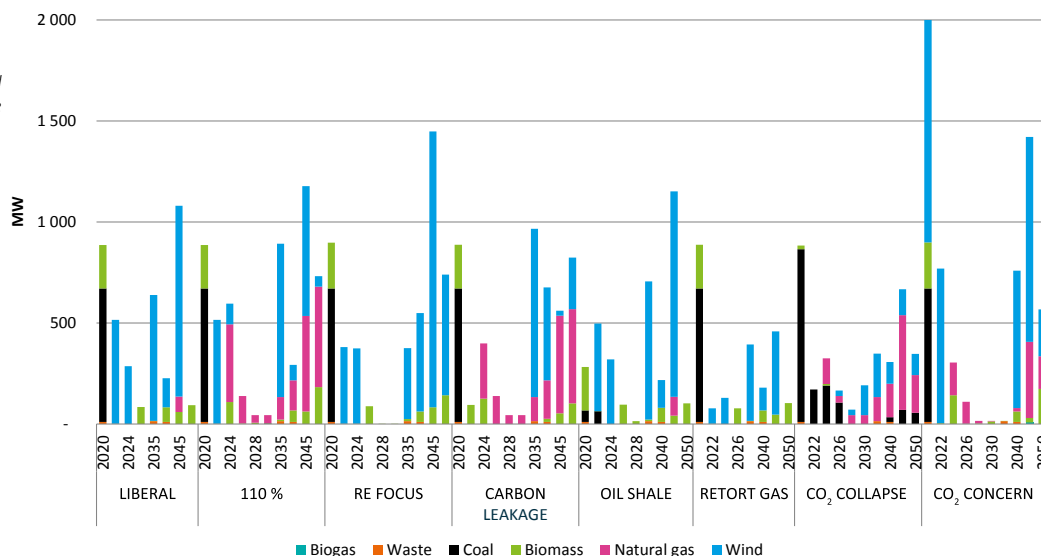

Figure 37 and Table 13 show how the 110% electricity capacity requirement is met in the 110% scenario. The main conclusion is that natural gas generation will be deployed to meet this requirement in the most cost efficient way. The 110% requirement decreases the development of wind power, since intermittent technologies, e.g. wind, do not count towards meeting this requirement.

Figure 37: Illustration of how the 110% capacity requirement is met in the 110% scenario

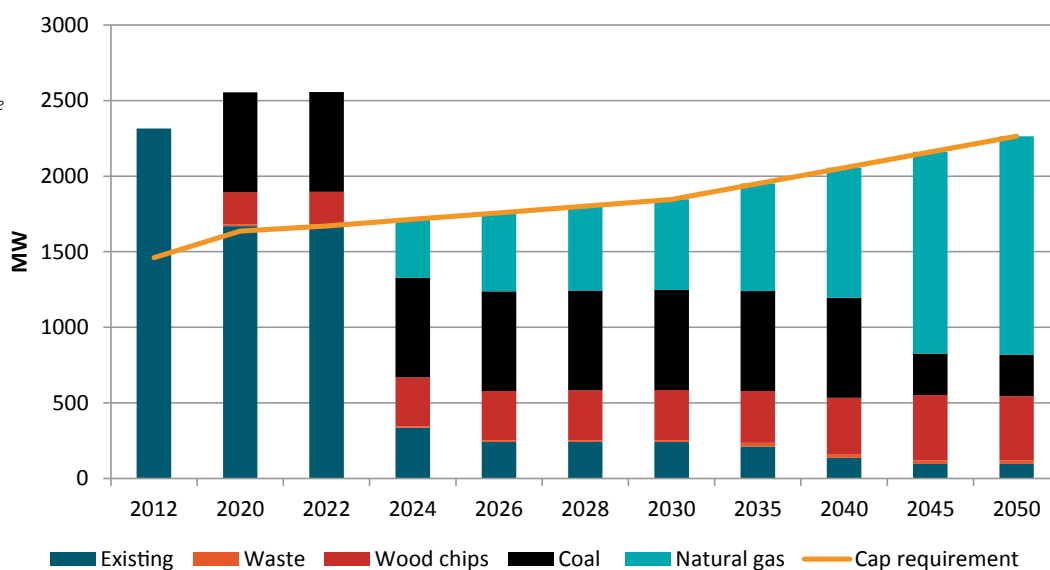

Table 13: Extra investments due to the 110% requirement. The table shows the difference in investment between the 110% and the liberal market scenario

MW	Biomass	Natural gas	Wind	Total	Total
	Estonia	Estonia	Estonia	Estonia	Other countries
2024-2030	+48	+497	-288	+257	+30
2035-2050	+79	+1,278	-179	+1,179	-38
Total	+127	+1,776	-467	+1,436	-8

Results - Economy

In this section the economy for the stakeholders is shown as the net present value (5%) over the entire simulation period until 2050. As can be seen from Table 11 the oil shale, the retort gas and the renewable energy scenarios can be directly compared with the liberal scenario, while CO₂ collapse, Carbon leakage and CO₂ concern can be directly compared with the 110% scenario.

Figure 38:
The overall economic impact of four scenarios compared to the liberal scenario

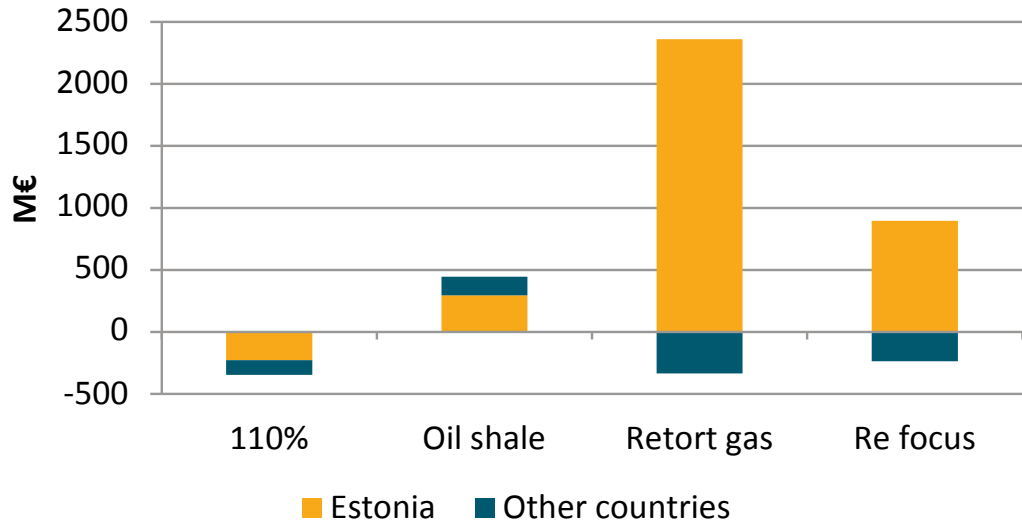

Figure 39:
The overall economic impact of three scenarios compared with the 110% scenario

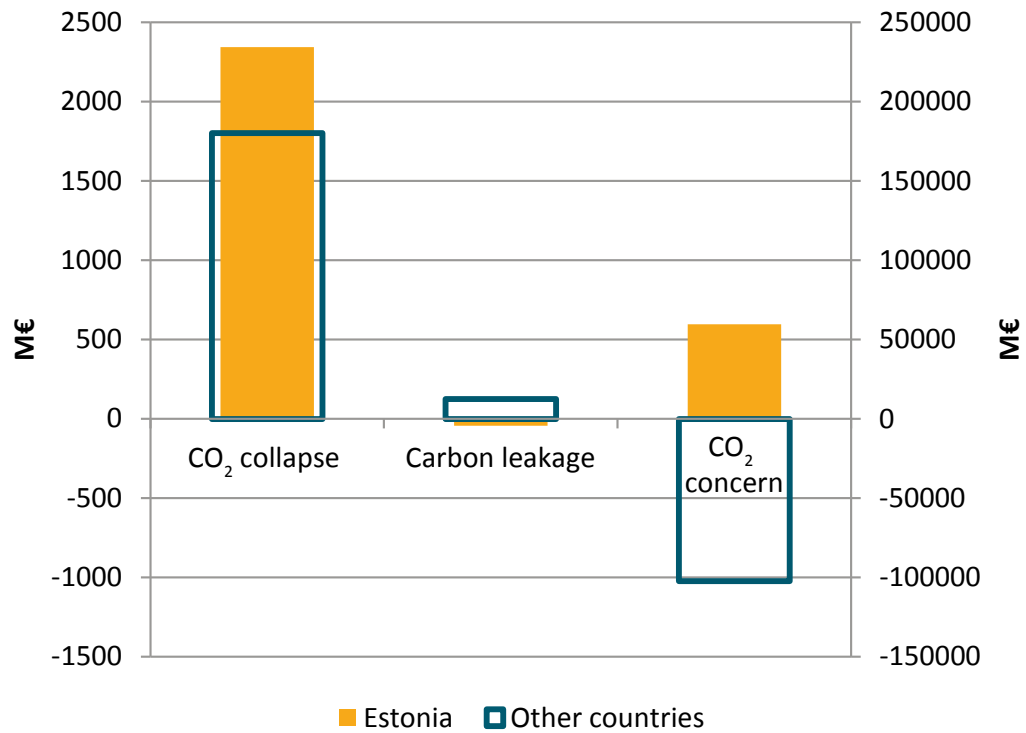

Table 14 shows the economy of having an Estonian 110% requirement. Only the difference relative to the liberal market is shown. For the entire model area the 110% requirement costs 346 M€. For Estonia the total cost is 227 M€³⁸. The extra local capacity results in lower prices, which is a benefit for consumers.

For the generators the total loss of 566 M€ (net present value) consist of extra investments and fixed costs of 236 M€, and 330 M€ in reduced income (extra fuel and CO₂ cost minus extra revenues). If it is assumed that the generators would need a subsidy of 566 M€, this would correspond to 6 €/MWh collected from all Estonian electricity demand in the period 2024 to 2050³⁹ in net present value.

Table 14:
Economic consequences of the 110% scenario compared to the liberal market

(M€ euro)	ESTONIA	LATVIA	LITHUANIA	RUSSIA	NORDIC	GERMANY & POLAND	TOTAL
			110%				
Generator profits	-556	-96	-111	49	-600	-192	-1,516
Consumer surplus	351	32	16	-18	639	333	1,352
TSO profit	-12	7	-2	12	-117	-69	-181
Socio economic benefit	-227	-57	-98	43	-78	72	-346

39

This subsidy level of 6 €/MWh is calculated dividing the NPV value of 566 M€ for generators with the NPV of all Estonian electricity demand in the period from 2024 to 2050

The total undiscounted costs of the 110% requirement has been calculated to a cost of approximate 1000 M€ for the entire model area. This is the costs for all years in the period 2012-2050.

Table 15 shows the economic results for the CO₂ concern scenario compared to the 110% scenario. The results are shown in two steps. In the first step the CO₂ price is increased and this results in extra costs in Estonia of 437 M€. Reducing the energy consumption as described in the energy efficiency scenario is such a benefit that it outweighs the initial costs (benefit of 596 M€ with high CO₂ price and low energy consumption in Estonia). However, it should be remembered that the cost of achieving the lower energy consumption (investments and the cost of the political instruments) is not included in figures presented in the table.

Table 15:
The CO₂ concern scenario compared to the 110% scenario. First step (top) is the scenario with the high CO₂ price, but with BAU development in the energy consumption. The lowest part shows the same simulation, but with reduced energy demand in Estonia. The difference between these two simulations is shown in the middle of the table

(M€ euro)	ESTONIA	LATVIA	LITHUANIA	RUSSIA	NORDIC	GERMANY & POLAND	TOTAL
CO₂ concern							
Generator profits	587	1,052	3,204	12,945	21,695	24,723	64,207
Consumer surplus	-1,148	-1,366	-2,272	-16,934	-24,581	-123,118	-174,420
TSO profit	124	117	-345	195	6,526	833	7,449
Socio economic benefit	-437	-197	587	-3,794	-1,360	-97,562	-102,764
Impact of EE							
Generator profits	121	-33	40	-274	358	-242	-28
Consumer surplus	911	22	29	237	-387	253	1,066
TSO profit	0	-6	9	16	4	-27	-4
Socio economic benefit	1,033	-16	78	-21	-25	-15	1,033
CO₂ concern (EE)							
Generator profits	709	1,020	3,244	12,671	22,054	24,482	64,179
Consumer surplus	-237	-1,344	-2,243	-16,697	-29,968	-122,865	-173,354
TSO profit	124	111	-336	210	6,529	806	7,445
Socio economic benefit	596	-214	665	-3,815	-1,385	-97,577	-101,731

Table 16 shows the CO₂ collapse and the carbon leakage scenarios compared to the 110% scenario. The Carbon leakage scenario (where the CO₂ price in Russia is set to 0 €/ton) create – as expected – a huge benefit for Russia. The impact on Estonia (as a whole) is limited to a 44 M€ loss. However, significant losses are placed on Estonian generators.

The CO₂ collapse scenario – where the CO₂ price is set to zero – is a benefit for all countries. First of all the electricity price is reduced with positive benefits to consumers. Estonia is the only country where the generators benefit from the change. This is due to the CO₂ intensity of the Estonian electricity generating sector due to the oil shale based plants.

In the CO₂ collapse scenario it requires extra focus to fulfil the renewable energy targets for 2020-2050. The shadow price⁴⁰ is 9 €/MWh on average (2020-2050). This can be understood as the subsidies needed for renewable electricity generation to reach the target. In all other scenarios the CO₂ price is sufficient to fulfil the renewable energy target by commercial investments.

Table 16:
The CO₂ collapse and the carbon leakage scenarios compared to the 110% scenario

(M€ euro)	ESTONIA	LATVIA	LITHUANIA	RUSSIA	NORDIC	GERMANY & POLAND	TOTAL
CO₂ concern							
Generator profits	113	-1,705	-2,752	-21,737	-87,066	-50,741	-163,888
Consumer surplus	2,199	2,768	4,172	30,722	95,026	210,702	345,589
TSO profit	32	-59	50	4	1,264	-503	788
Socio economic benefit	2,344	1,004	1,470	8,989	9,224	159,458	182,489
Carbon leakage							
Generator profits	-411	-476	-421	-18,864	-3,962	-1,509	-25,643
Consumer surplus	279	234	153	29,696	3,633	2,895	36,890
TSO profit	89	144	-219	961	266	-37	1,204
Socio economic benefit	-44	-98	-486	11,793	-64	1,349	12,450

Table 17 shows the oil shale and the retort gas scenarios compared to the liberal scenario. Both scenarios describe the impact of supplying cheap fuel to the electricity sector. For the retort gas scenario the cost of the gas is not included. As expected both scenarios result in significant profit for the Estonian generators⁴¹.

In the oil shale scenario oil shale will be used for a longer period than in the liberal scenario. However, even in the oil shale scenario the use of oil shale is reduced to 41 PJ in 2020 and 12 PJ in 2030 (compared with 118 PJ in 2012).

Table 17:
The oil shale and the retort gas scenarios compared to the liberal scenario

(M€ euro)	ESTONIA	LATVIA	LITHUANIA	RUSSIA	NORDIC	GERMANY & POLAND	TOTAL
Oil shale							
Generator profits	359	-42	67	-258	-1,321	144	-1,080
Consumer surplus	-69	-53	-39	263	1,459	78	1,637
TSO profit	5	-6	9	0	-87	-33	-112
Socio economic benefit	295	-101	37	6	51	159	446
Retort gas							
Generator profits	2,285	-202	-139	-177	-1,529	-609	-371
Consumer surplus	84	70	35	150	1,524	743	2,606
TSO profit	-10	22	-26	-9	-123	-62	-209
Socio economic benefit	2,360	-111	-130	-36	-128	72	2,026

Table 18 shows the result for the renewable energy scenario. This is done in two steps so that the impact for the lower energy consumption can be seen clearly.

Note that the requirements for renewable energy are strongest at the end of the simulation period (2050) and the impact is significantly reduced in the computation of the net present value. 1 € in 2012 is equal to 6.4 € in 2050 when using 5% real p.a. as interest rate.

Already from 2020 the requirements of not investing in fossil fuel based generation change the scenario – compared to the liberal market.

The requirement has a total costs of 135 M€ for the model area. However, for Estonia there is a net benefit of 62 M€.

When the renewable energy target in Estonia is applied there will be an extra cost for the entire system. This cost will not necessarily be located in Estonia, but somewhere in the system. The RE requirement in Estonia will also change the investment pattern in the other countries in the system. Additional RE investments will normally increase the capital costs and decrease consumer prices and the balance between these are decided by the interest rate. When we run the model we use a 10% interest rate and 20 years payback time. When we evaluate the stakeholder economy we use 5 % and 20 years - these 5 % results in a positive economic result for Estonia. If we apply a 10 % interest rate in the stakeholder economy the positive economy for Estonia will be changed to a cost of 45 M€. This is due to the investments in the RE scenario has higher capital costs, which will take place in the last part of the period, with a 10 % interest rate, will have less importance for the net present value. A general result from the study, when you look at the other scenarios, is that the majority of the RE investments are competitive even without a RE target as they are facilitated by the CO₂ price. Therefore the difference in costs between the liberal market scenario and the RE scenario will be at the end of the period towards 2050 when the model takes the final steps to reach the 100 % target. The costs at this point in time will have less importance in a net present value calculation.

In the RE focus scenario most of the investments in renewable energy is made without the need for subsidies. However, towards the end of the period after 2040 all cheap options are used and a subsidy of 5 EUR per MWh electricity is needed⁴². It should be noted that the relatively low subsidy level needed in this scenario is due the application of a CO₂ price which is significantly higher than the current level of the CO₂ price. If the CO₂ price development is e.g. lower than estimated, it will require an increased RE subsidy to meet this target throughout the period and vice versa. In addition to this, as mentioned above, the RE target leads to economic losses for the generators and lower whole sale energy prices for the consumers. As it can be seen in the table below, the generators have a total loss of 779 M€ in this scenario when excluding the EE effects. This is a method of calculating how the generators should be compensated in order to achieve the RE scenario.

⁴¹ Investments costs for the retort gas turbines is set to the costs of a combined cycle gas turbine. This is set to 0.8 mEUR/MW_{el}, which is a total investment cost of 576 mEUR for the retort gas capacity of 720 MW_{el}.
⁴² The subsidy level is calculated as a shadow price

Table 18:
The renewable energy scenario compared to the liberal scenario. First step (top) shows the impact of the renewable energy requirement in Estonia. The second step shows the impact of lower energy demand. Finally, step three shows the impact of renewable energy requirement and lower energy demand combined

(M€ euro)	ESTONIA	LATVIA	LITHUANIA	RUSSIA	NORDIC	GERMANY & POLAND	TOTAL
RE focus							
Generator profits	-779	-152	29	-9	77	-32	-866
Consumer surplus	840	2	-3	0	-71	-38	730
TSO profit	1	3	1	3	-9	2	1
Socio economic benefit	62	-147	27	-6	-3	-68	-135
+EE							
Generator profits	3	-25	-86	-160	-574	-221	-1,063
Consumer surplus	836	26	19	187	586	337	1,991
TSO profit	-5	-12	-10	24	-52	-78	-133
Socio economic benefit	834	-11	-78	52	-40	38	795
RE focus (EE)							
Generator profits	-776	-177	-58	-169	-497	-253	-1,929
Consumer surplus	1,676	28	16	187	515	298	1,721
TSO profit	-4	-10	-9	27	-61	-76	-132
Socio economic benefit	896	-158	-51	45	-43	-30	660

elering
ÜHENDAME ENERGIAD

Kadaka tee 42, 12915 Tallinn
telefon: 715 1222
faks: 715 1200
e-post: info@elering.ee

www.elering.ee

