

**Mootoriteaduse
käsiraamat**

II

E 43778

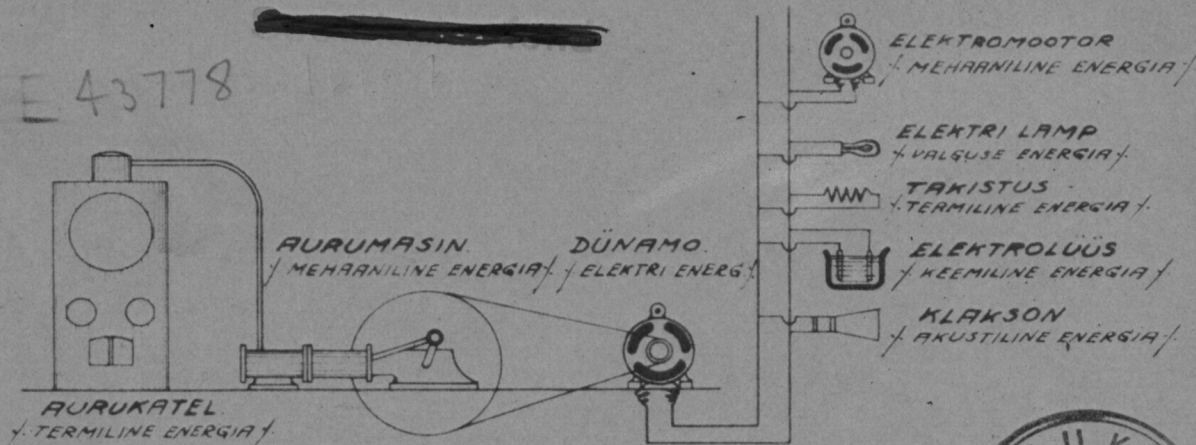

Joon. №1

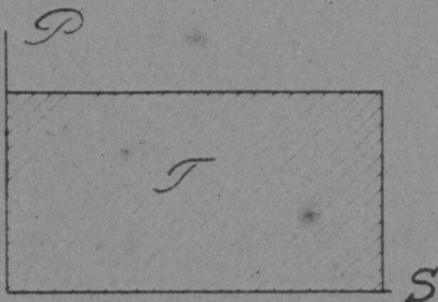

Joon. №2



Joon. №3

ESTONIA
Riiklik Avalik
Raamatukogu

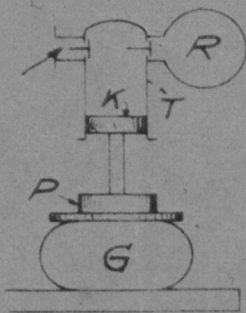

SOEND. AP.

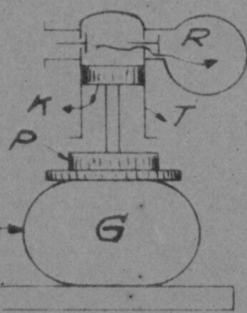

VALIS-
OHK.

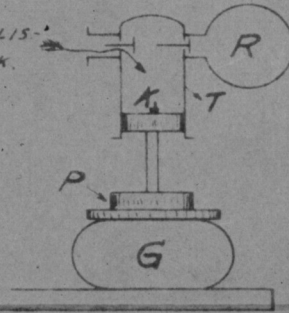

Joon. №4

Lennukooli
Raamatukogu
№ 4-2566

621.4



Ar 935
Mootoriteaduse
2-
teaduse

AR Fr. R. Kreutzwald
nim. ENSV Riiklik
Raamatukogu

42916

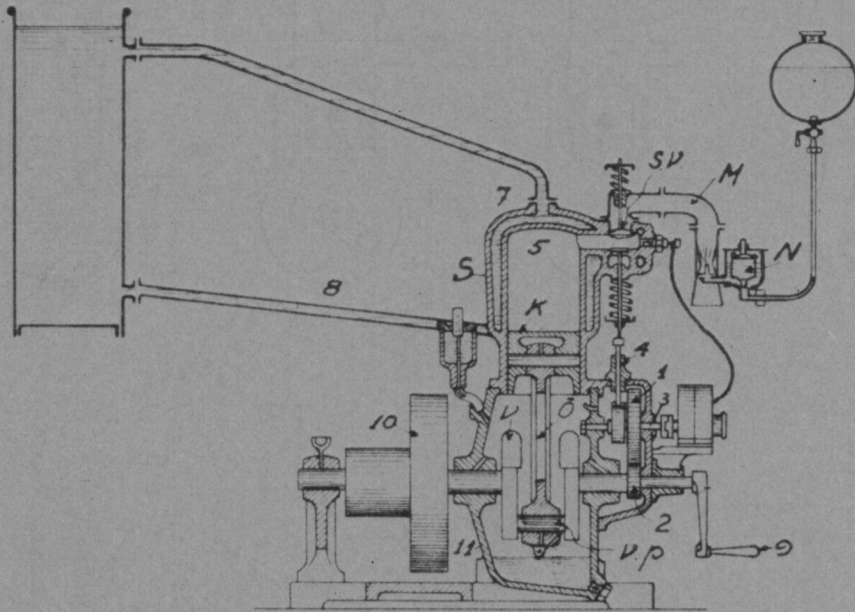

Foon № 5.

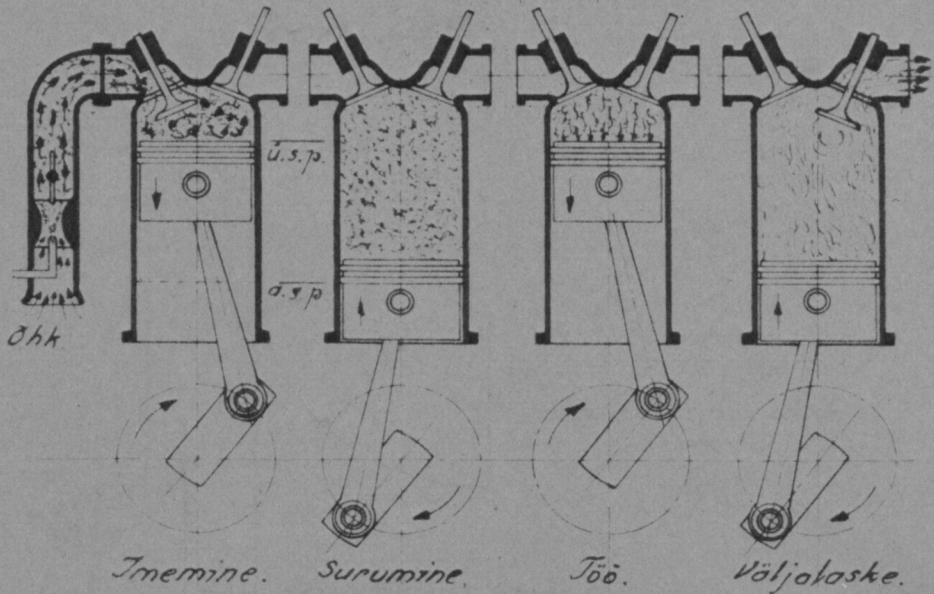

Foon № 6.

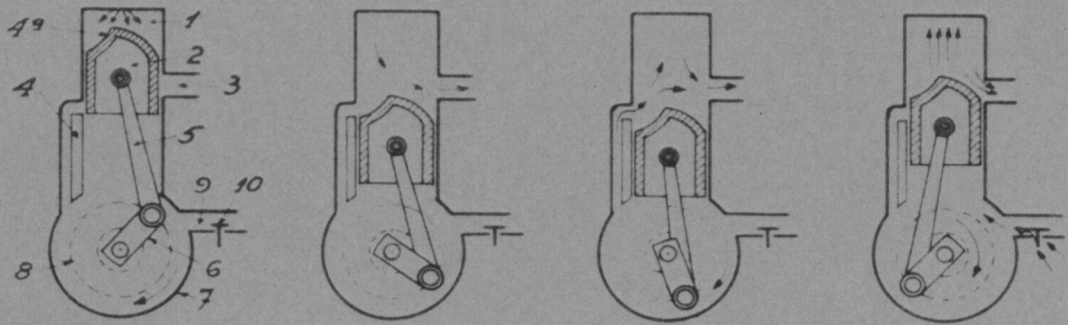

Joone №7

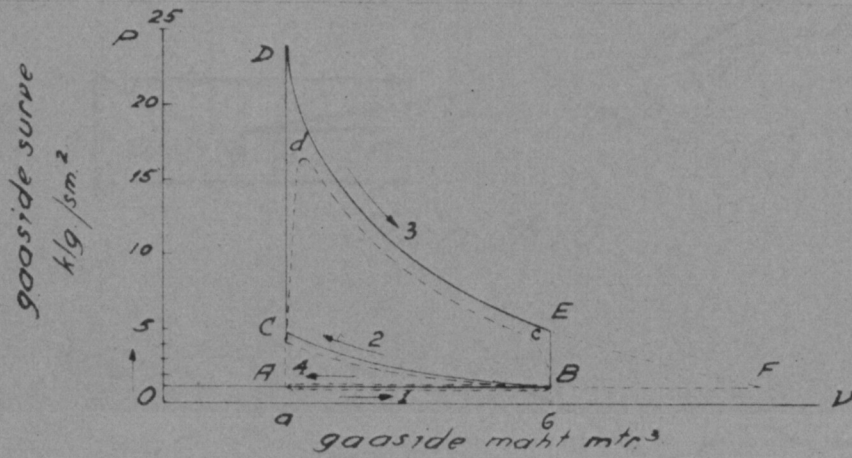

Joone №8.

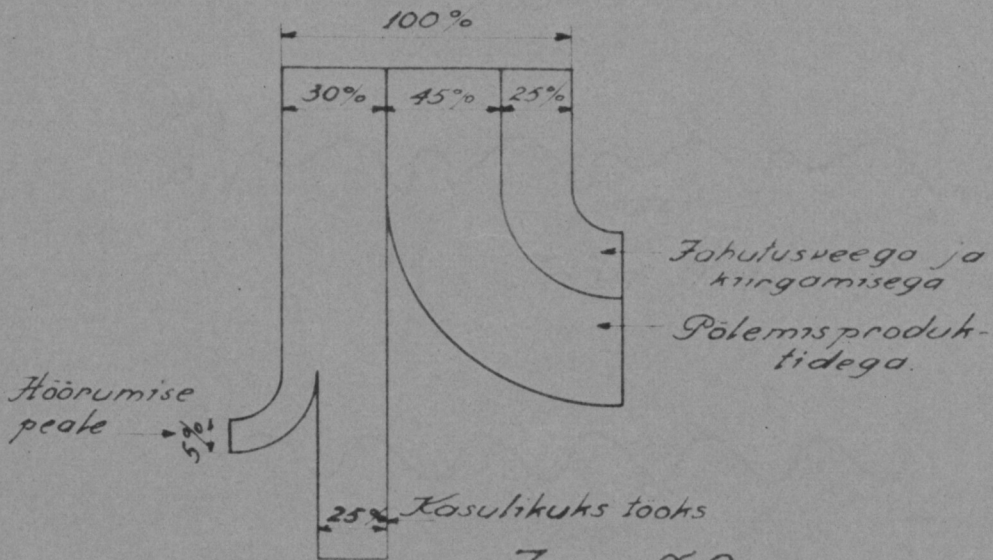

Joone №9.

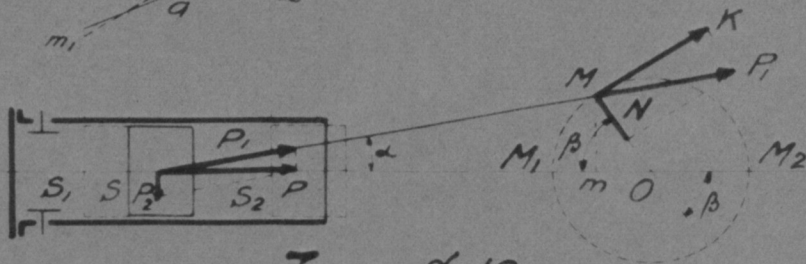
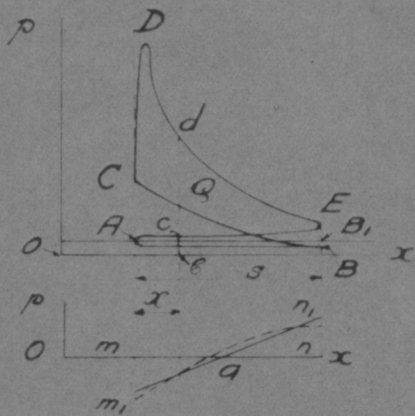

Фиг. № 10

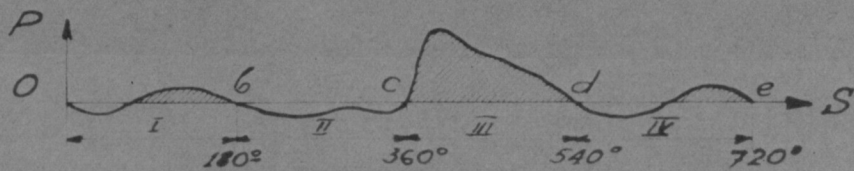

Фиг. № 11

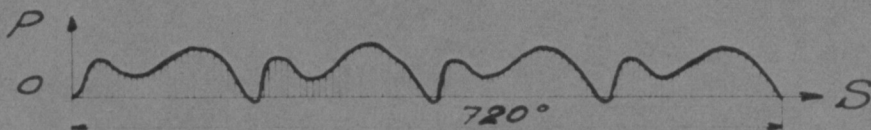

Фиг. № 12

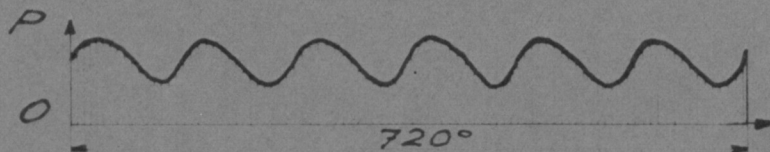

Фиг. № 13.

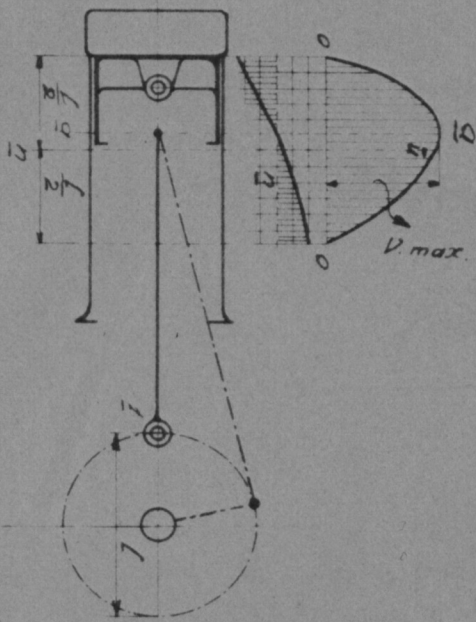

Fig. No. 14.

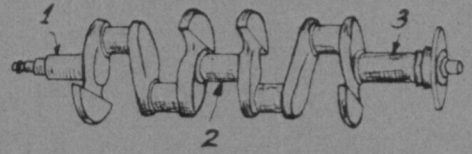

Fig. No. 15.

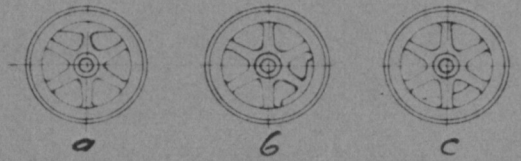

Fig. No. 16.

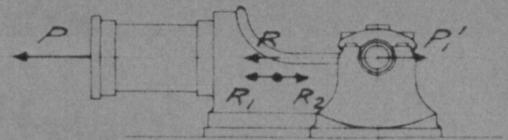

Fig. No. 17.

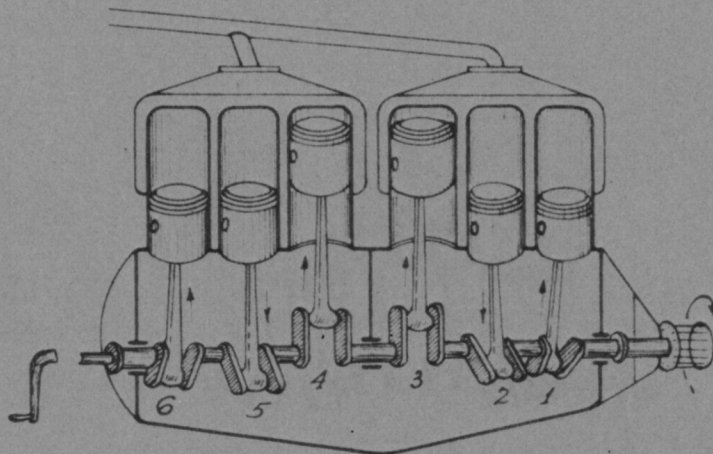
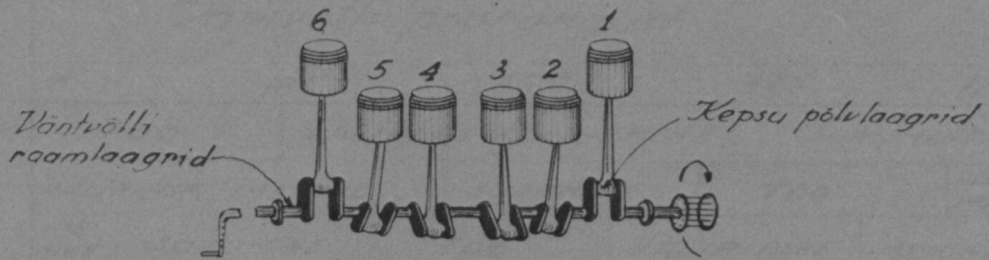
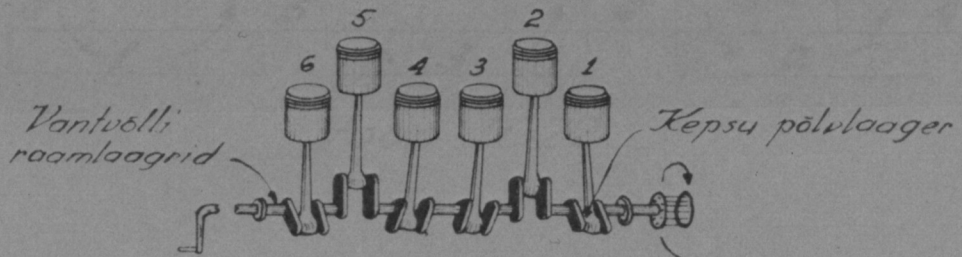

Fig. No. 18.



Foon. № 19.



Foon. № 20.

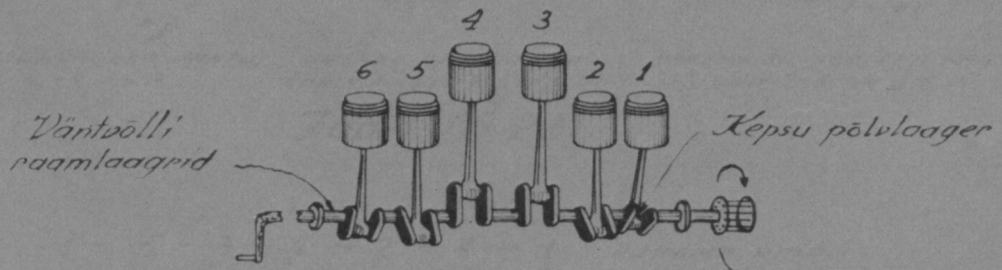

Foon. № 21.

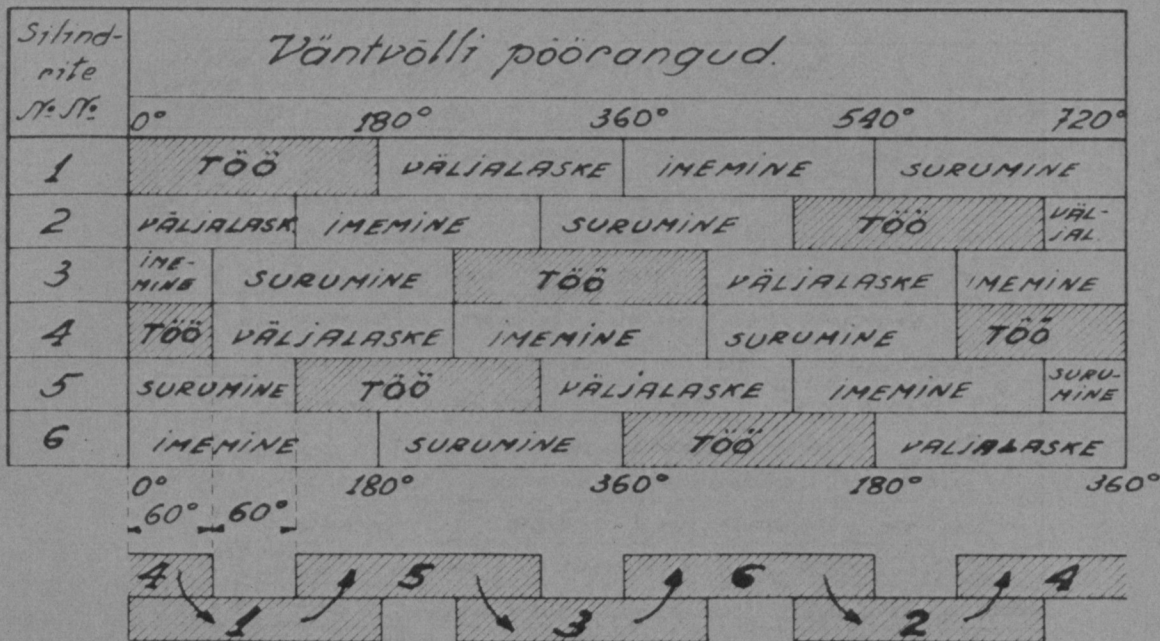

Foon. №22.

VASAKP. SILINDR. RIDA.

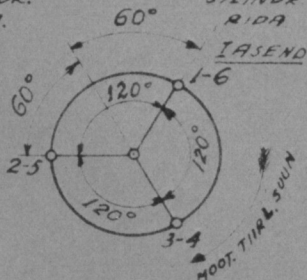

PAREMP SILINDR. REA VÄNTV. PÕLVED 1-6 ON Ü.S.P

VASAKP. SILINDR. RIDA

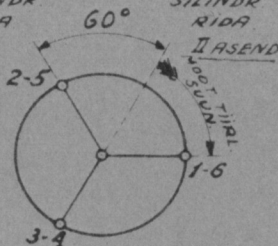

VASAKP. SILINDR. REA VÄNTV. PÕLVED 2-5 ON Ü.S.P

VASAKP. SILINDR. RIDA.

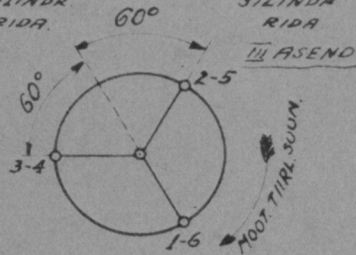

PAREMP SILINDR. REA VÄNTV. PÕLVED 2-5 ON Ü.S.P.

Foon. №23.

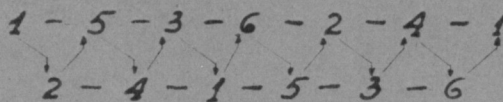

PAREMP RIDA

VASAKP. RIDA.

Foon. №24.

| Siltid. drite №№: | | Väntvölili pöörangud | | | | |
|-------------------|---|----------------------|------------|------------|------------|------------|
| | | 0° | 180° | 360° | 540° | 720° |
| 1 | 1 | TÖÖ | VÄLJALASKE | IMEMINE | SURUMINE | |
| 2 | 2 | VÄLJALASKE | IMEMINE | SURUMINE | TÖÖ | VÄLJ |
| 3 | 3 | IMEMINE | SURUMINE | TÖÖ | VÄLJALASKE | IMEMINE |
| 4 | 4 | TÖÖ | VÄLJALASKE | IMEMINE | SURUMINE | TÖÖ |
| 5 | 5 | SURUMINE | TÖÖ | VÄLJALASKE | IMEMINE | SURUMINE |
| 6 | 6 | IMEMINE | SURUMINE | TÖÖ | VÄLJALASKE | |
| 7 | 6 | IMEMINE | SURUMINE | TÖÖ | VÄLJALASKE | IMEMINE |
| 8 | 5 | SURUMINE | TÖÖ | VÄLJALASKE | IMEMINE | SURUMINE |
| 9 | 4 | VÄLJALASKE | IMEMINE | SURUMINE | TÖÖ | |
| 10 | 3 | SURUMINE | TÖÖ | VÄLJALASKE | IMEMINE | |
| 11 | 2 | VÄLJALASKE | IMEMINE | SURUMINE | TÖÖ | VÄLJALASKE |
| 12 | 1 | TÖÖ | VÄLJALASKE | IMEMINE | SURUMINE | TÖÖ |
| | | 60° | 180° | 360° | 180° | 360° |

Foon. №: 25.

468-55

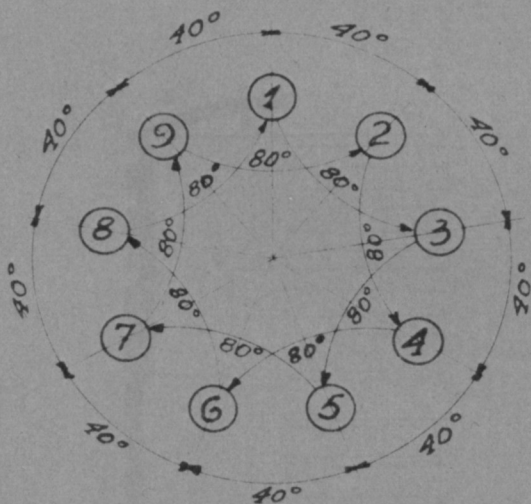

Foon. №: 26.

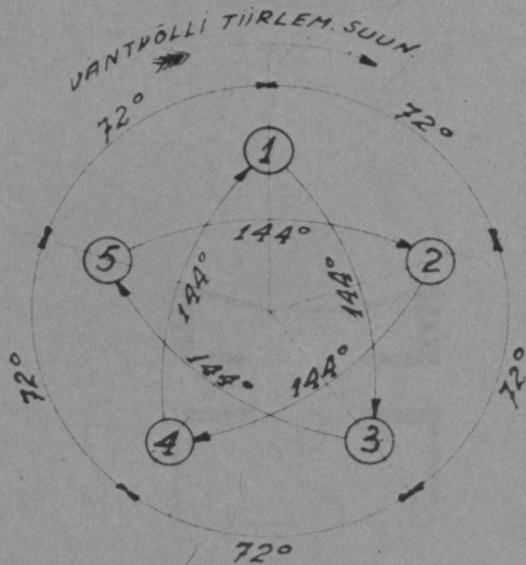

Foon. №: 27.

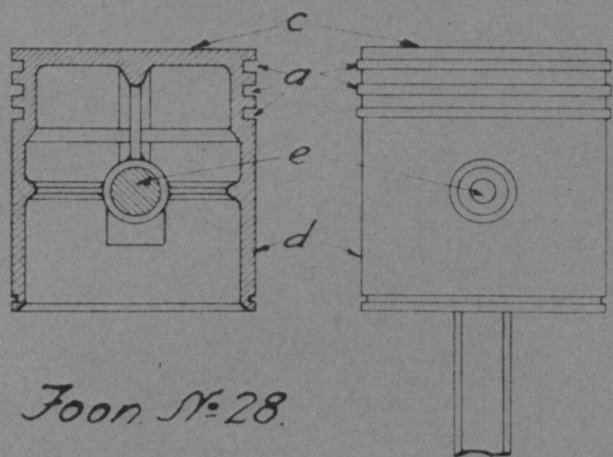

Foon №28.

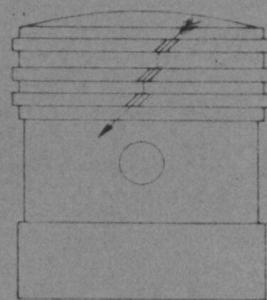

Foon №29

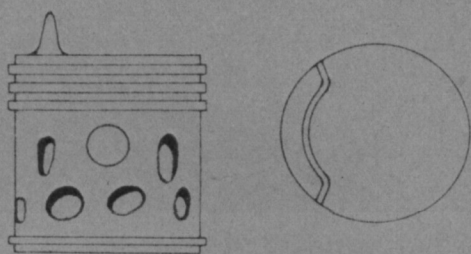

Foon №30

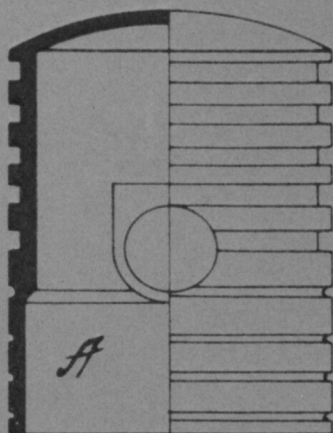
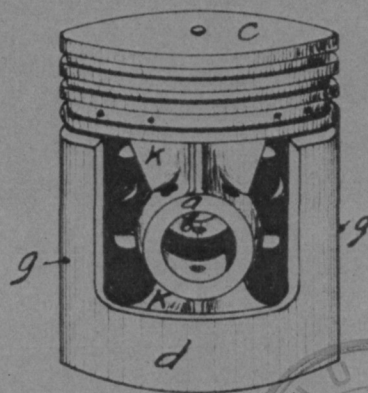

Foon №31.



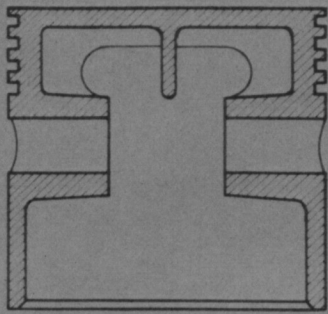

Foon. №32.

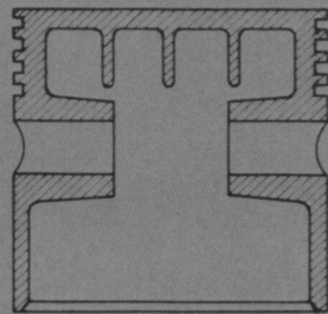

Foon. №33.

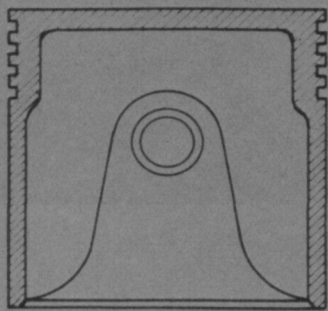

Foon. №34.

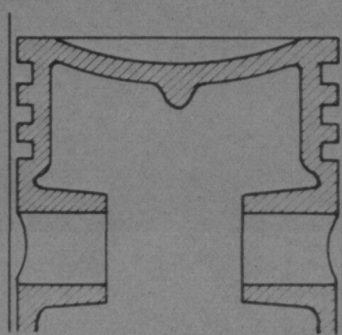

Foon. №35.

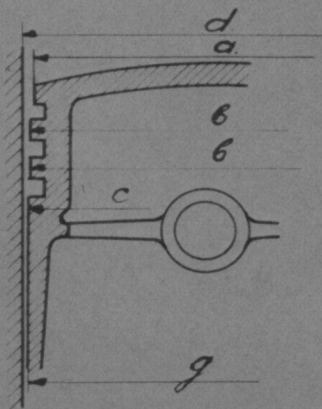

Foon. №36.

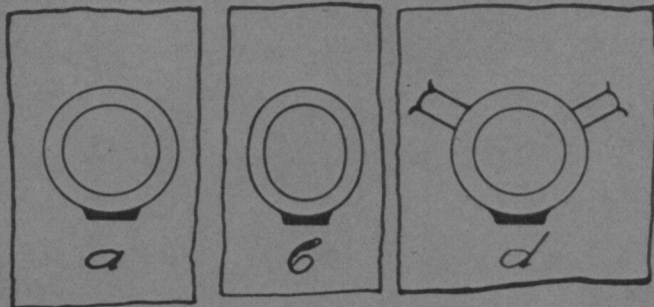

Foon. №37.

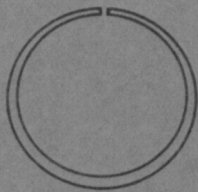

Foon. № 38.

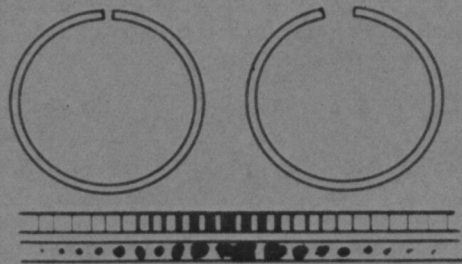

Foon. № 39.

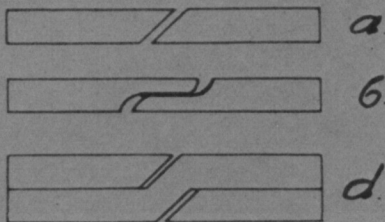

Foon. № 40.

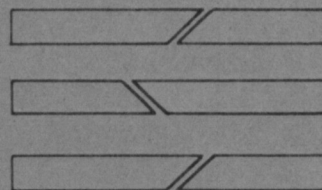

Foon. № 41.

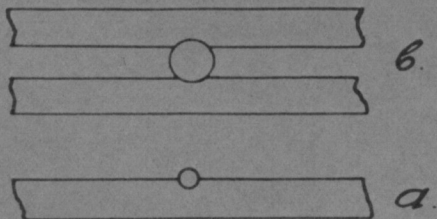

Foon. № 42.

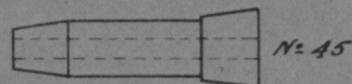
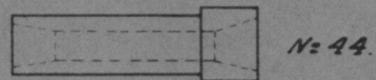

Foon. № 44, 45.

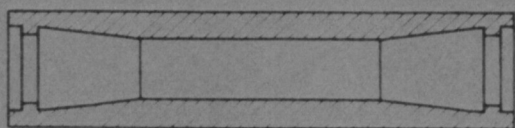

Footon №43.

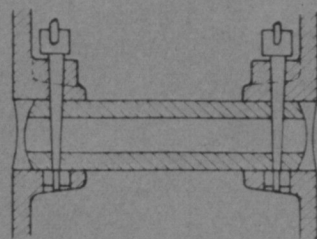

Footon №48.

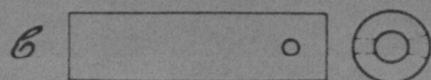
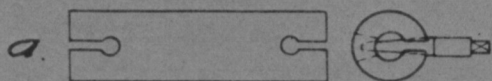

Footon №46.

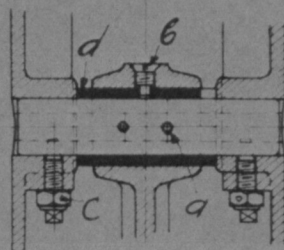

Footon №50.

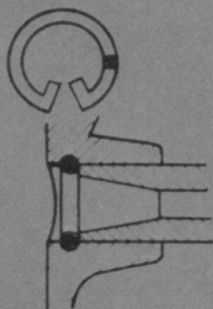

Footon №47.

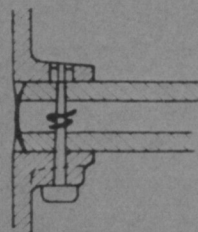

Footon №49.

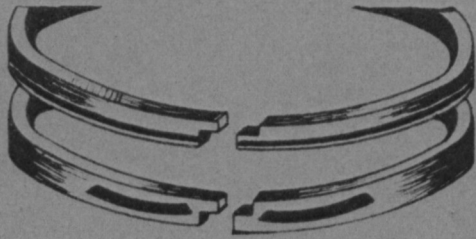

Foon №51

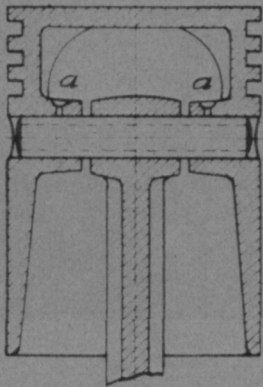

Foon №52

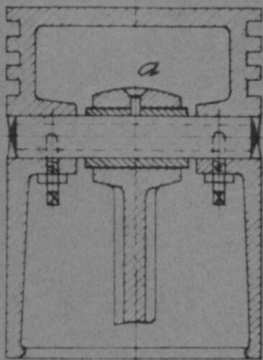

Foon №53

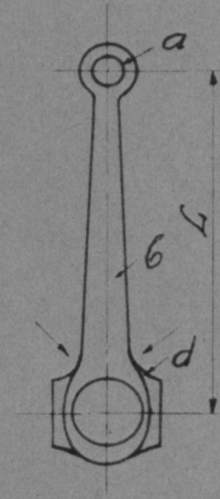

Foon №54

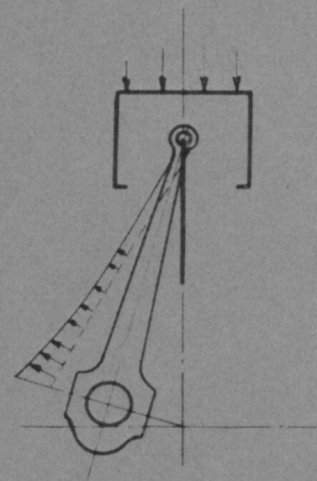

Foon №55

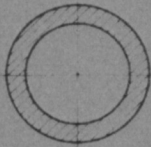

Form. № 56.

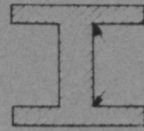

a

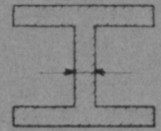

b

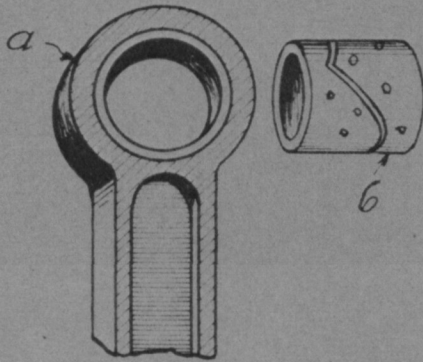

Form. № 58

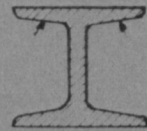

d

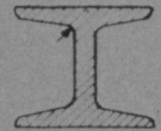

e

Form. № 57.

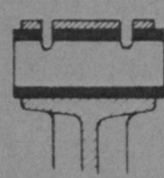
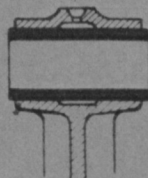
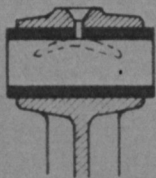

Form. № 59

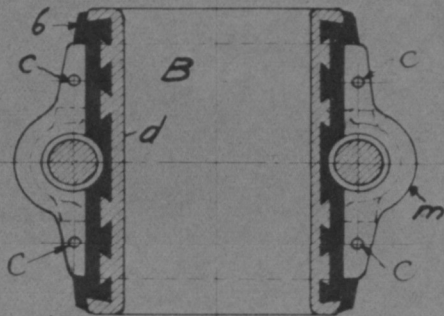
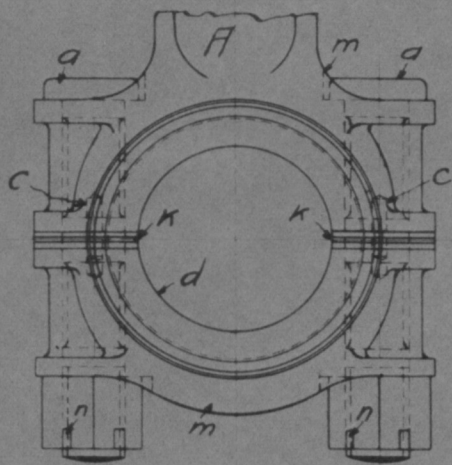

Foon №60.

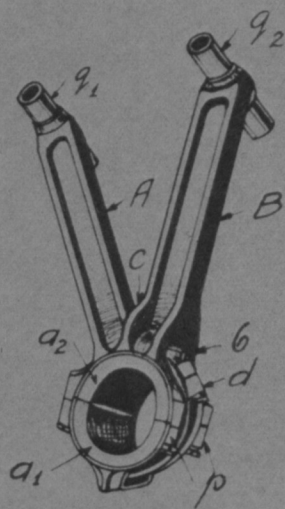

Foon №61.

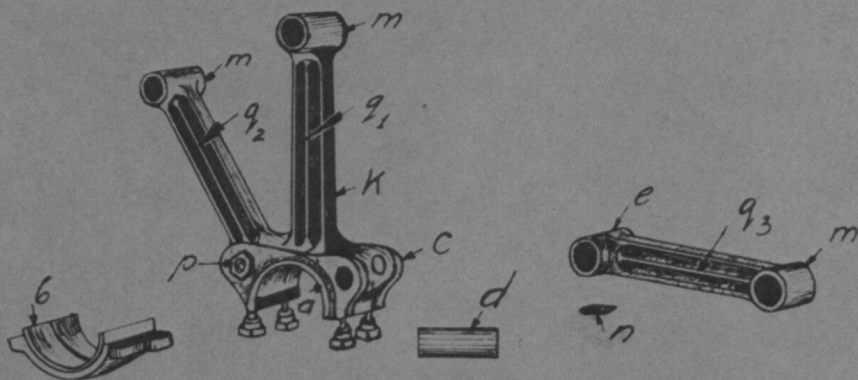

Foon №62.

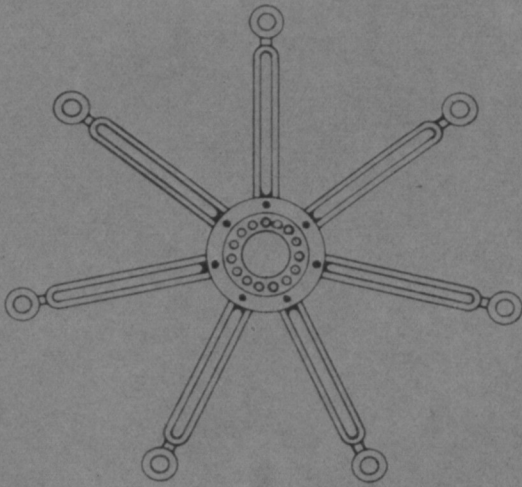

Foot №63.

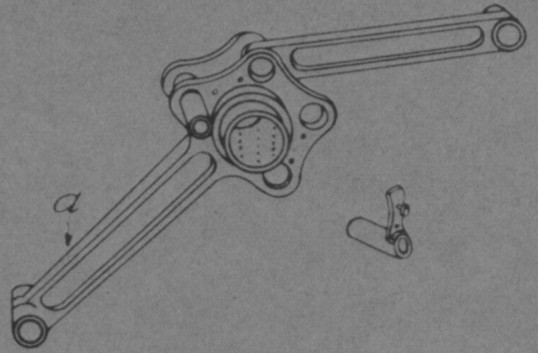

Foot №64.

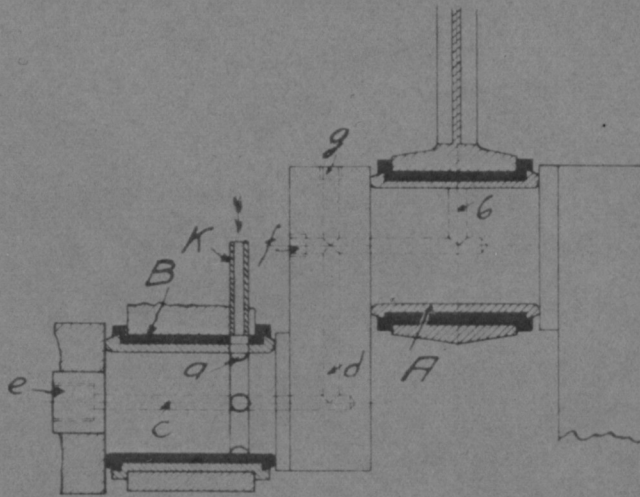

Foot №65.

1 silin.

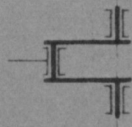

2 silin.

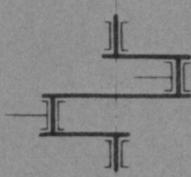

3 silin.

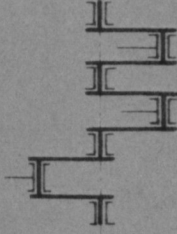

4 silin.

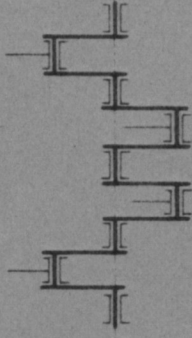

4 silin.

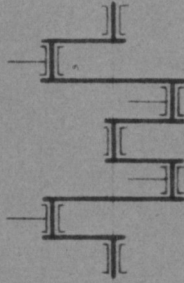

4 silin.

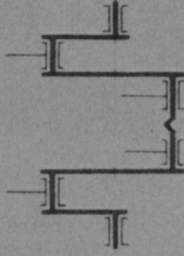

6 silin.

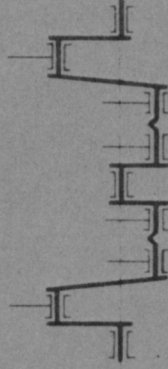

6 silin.

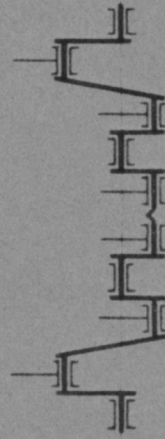

6 silin.

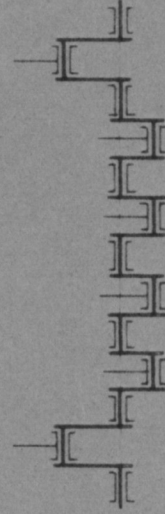

Foon N. 66.

Väntvöllli pöve kaelus.

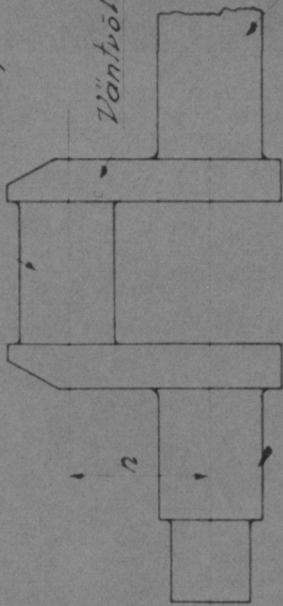

Väntvöllli pöve ölg.

Väntvöllli kaelus

Foon. № 67

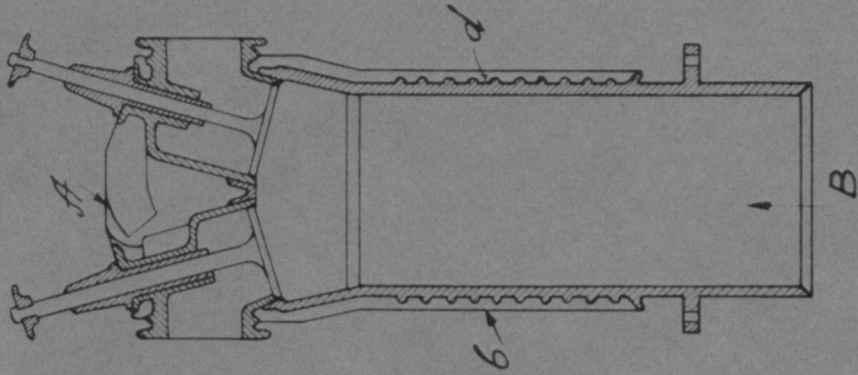

Foon. № 69.

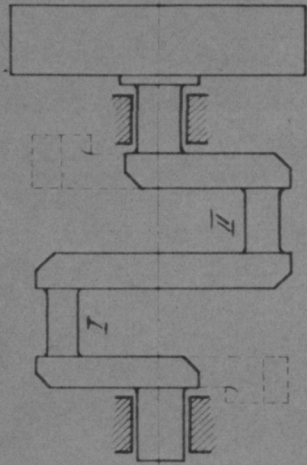

Foon. № 68.

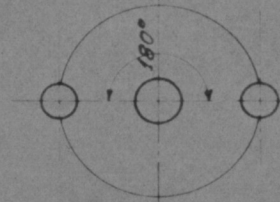

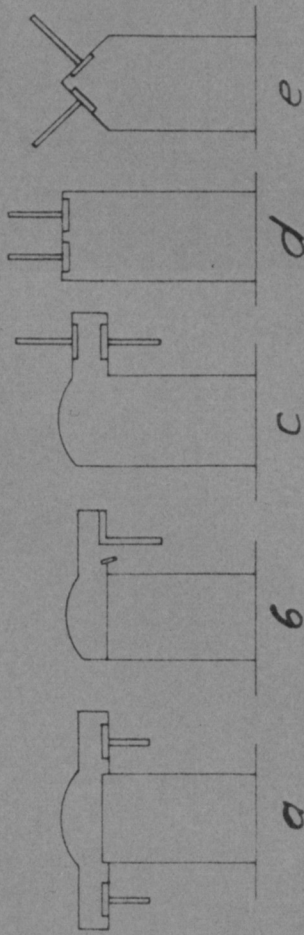

Foon. № 70

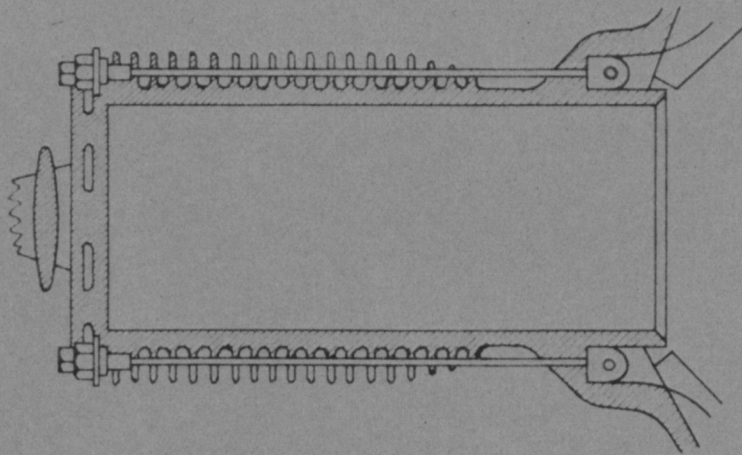

Foon. № 73

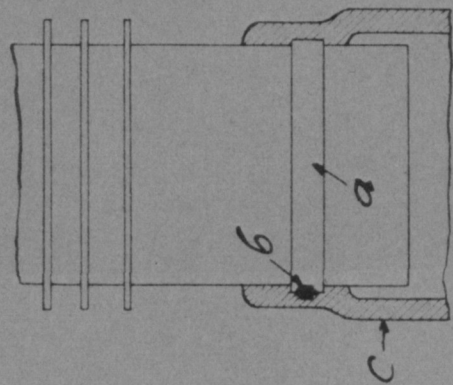

Foon. № 72

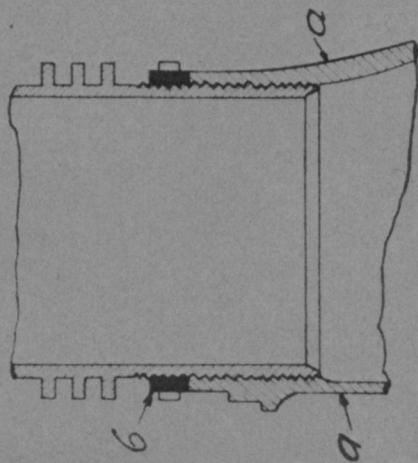

Foon. № 71

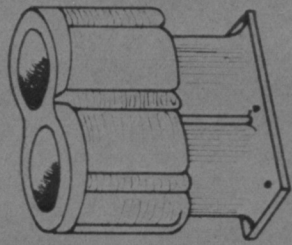

Зон. №74

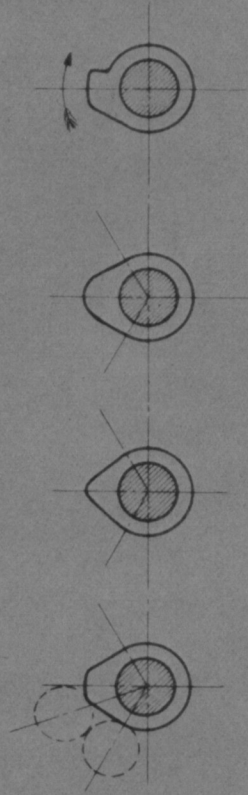

Зон. №76

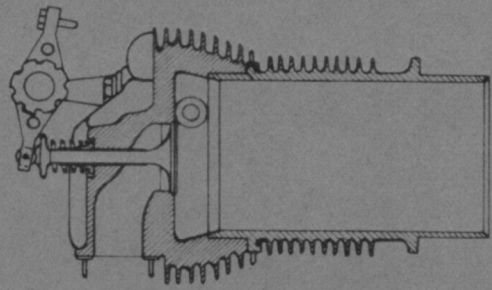

Зон. №75

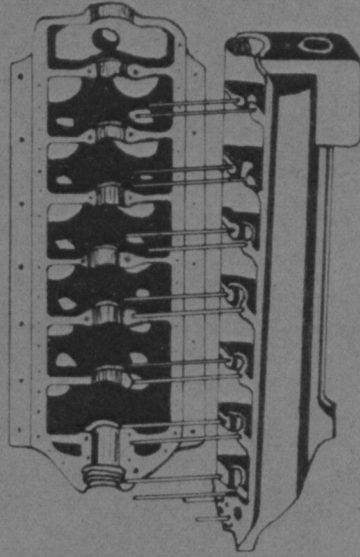

Зон. №77

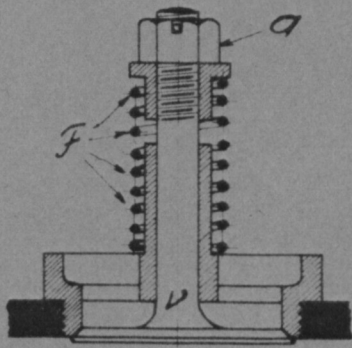

Fooon. № 78.

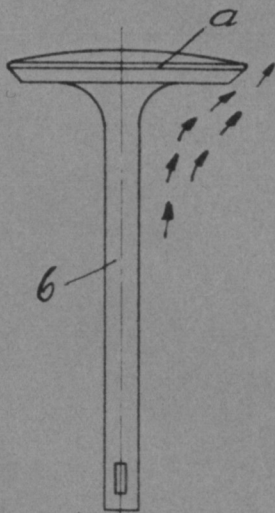

Fooon. № 80.

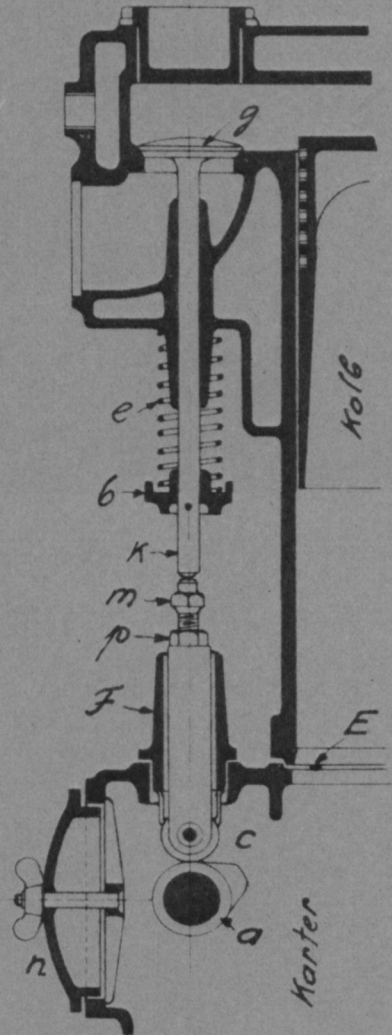

Fooon. № 79

Fr. R. Kreuzwäldi
nim. ENSV Riiklik
Raamatukogu

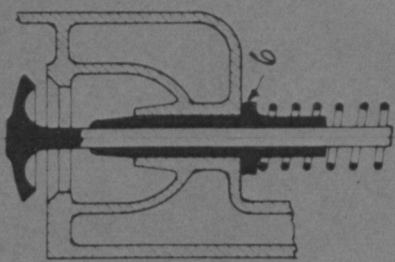

Foon. № 83

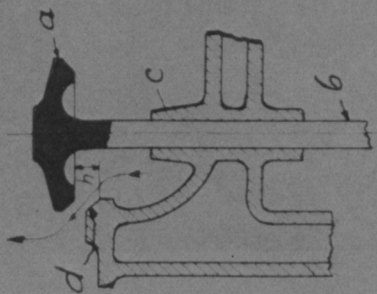

Foon. № 82

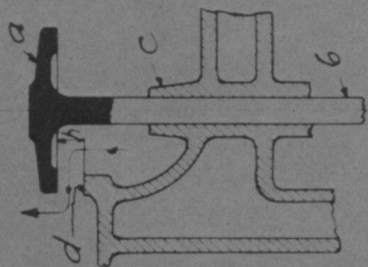

Foon. № 81

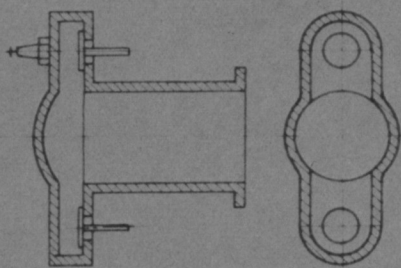

Foon. № 85

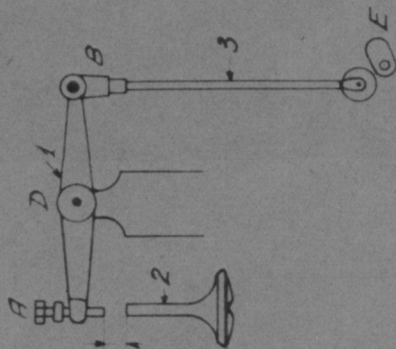

Foon. № 84

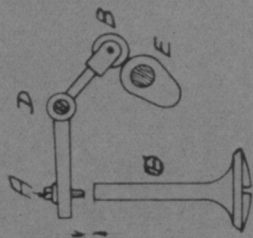

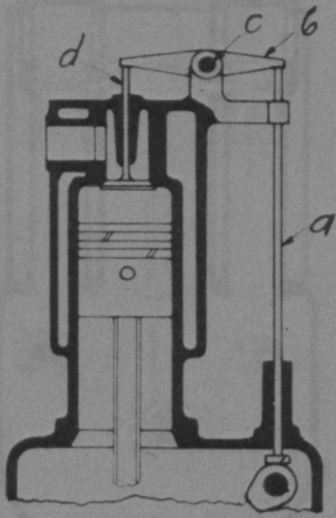

Foon №86

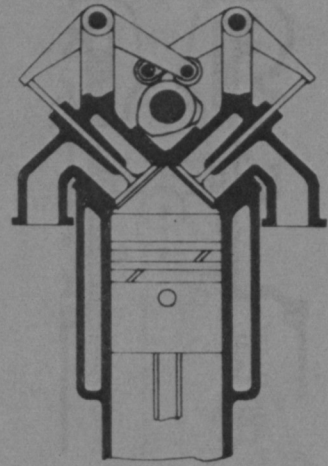

Foon №87

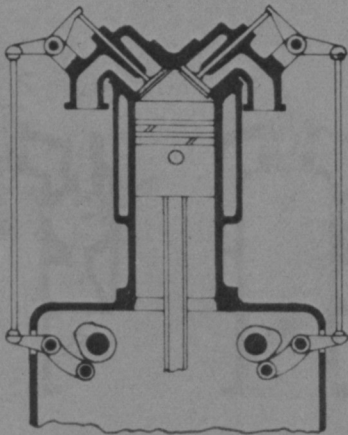

Foon №88

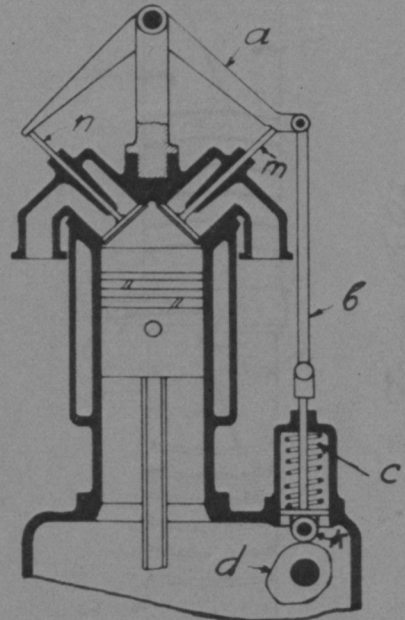

Foon №89

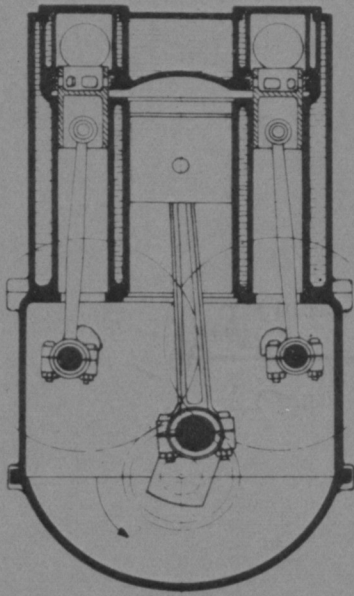

Foon. № 90

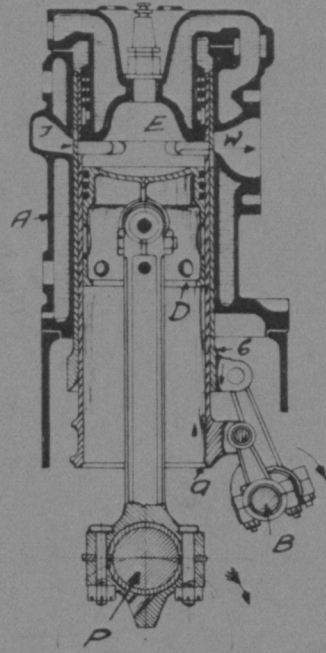

Foon № 92

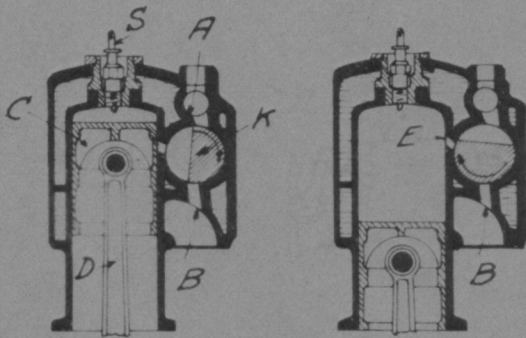

Foon. № 91

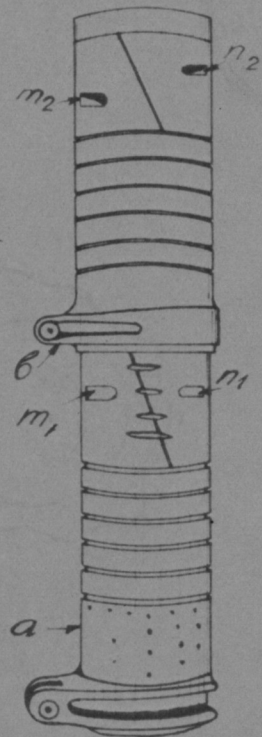

Foon. № 93.

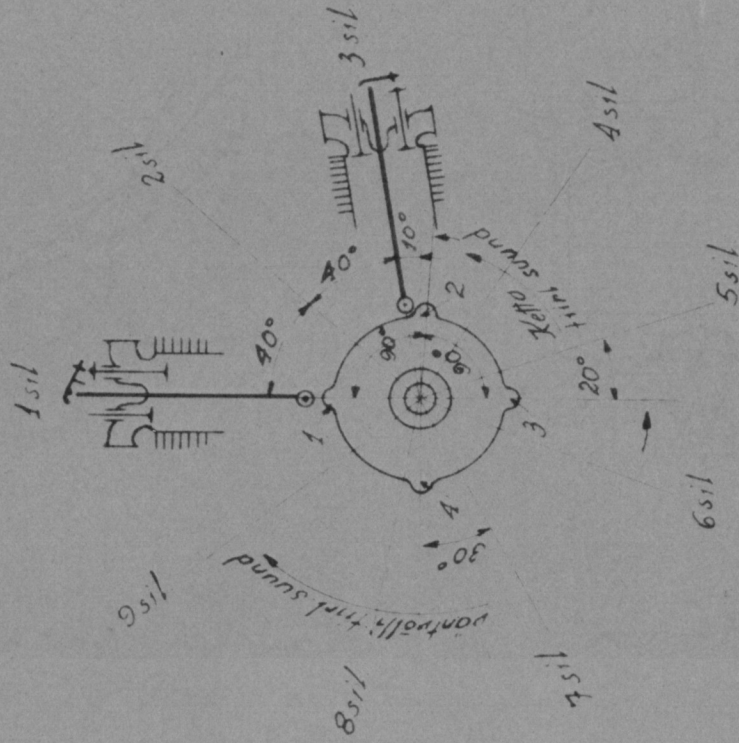

Foon №95.

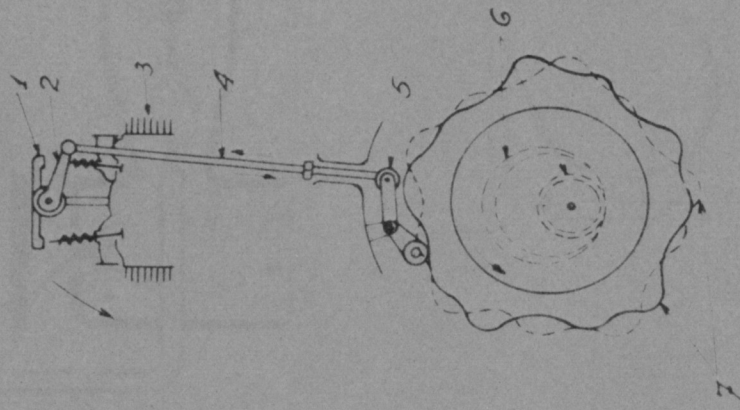

Foon №94.

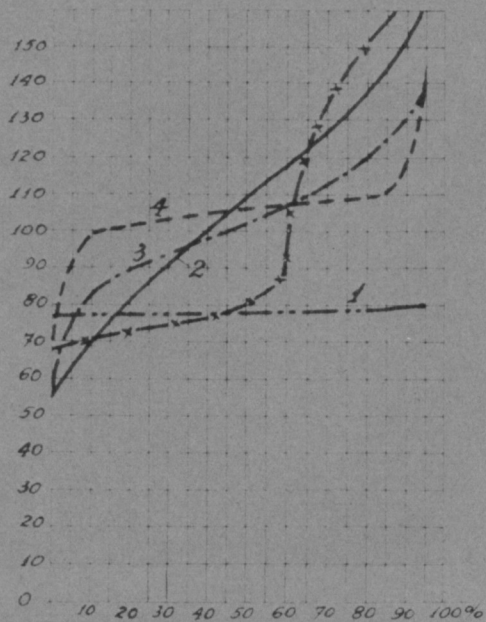

Foon. №96

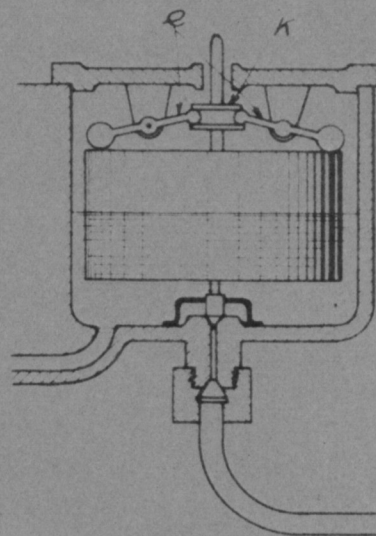

Foon. №98.

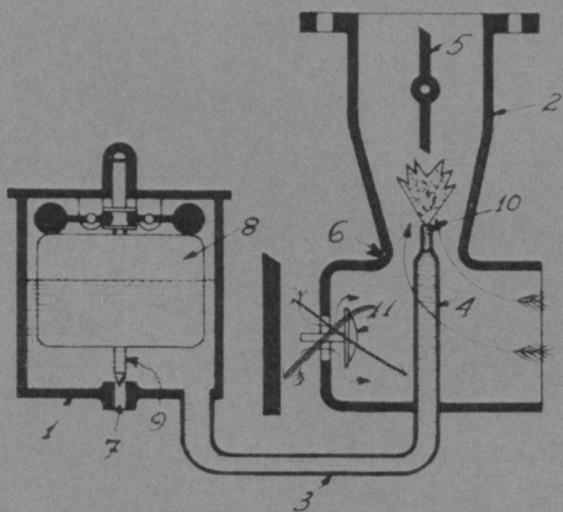

Foon. №97

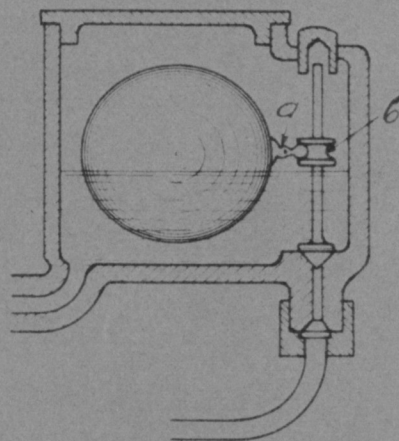

Foon. №99.

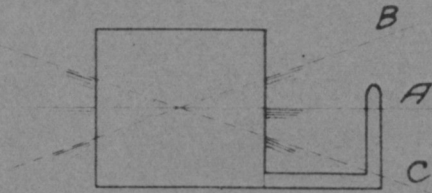

Foon. №100.

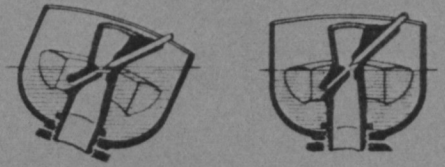

Foon. №101.

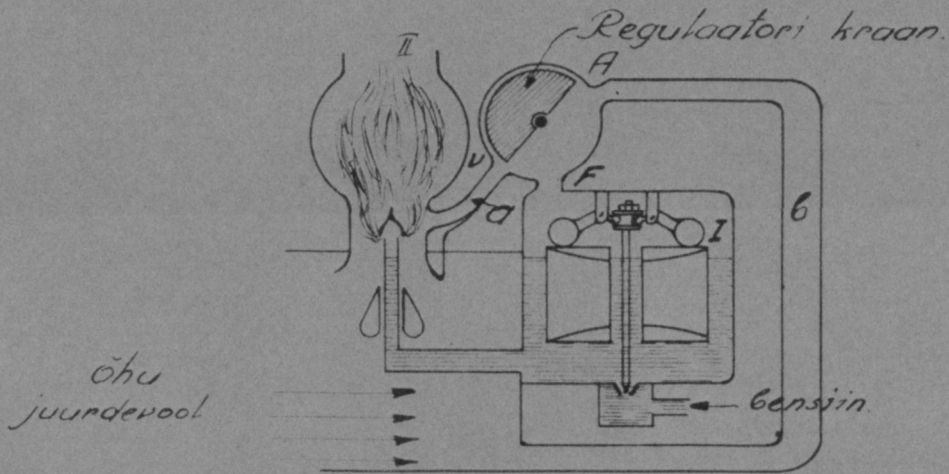

Foon. №102.

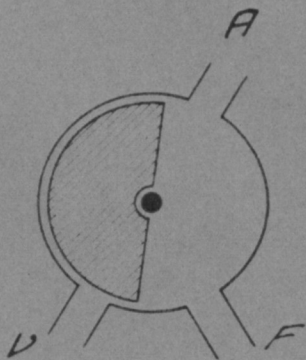

Foon. №103.

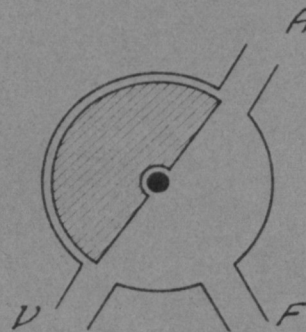

Foon. №104

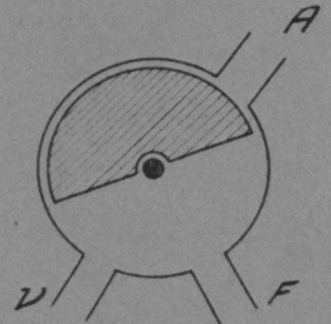

Foon. №105

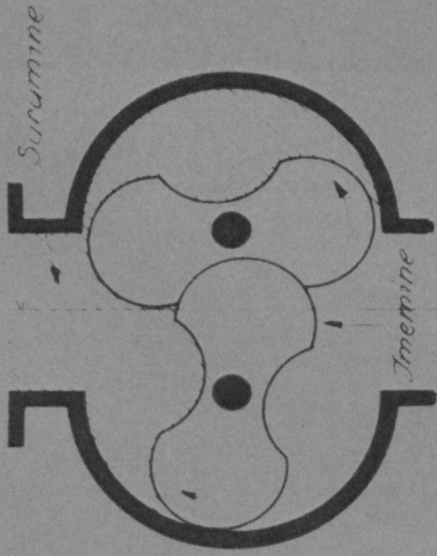

Surumine

Imemine

Foon. № 106

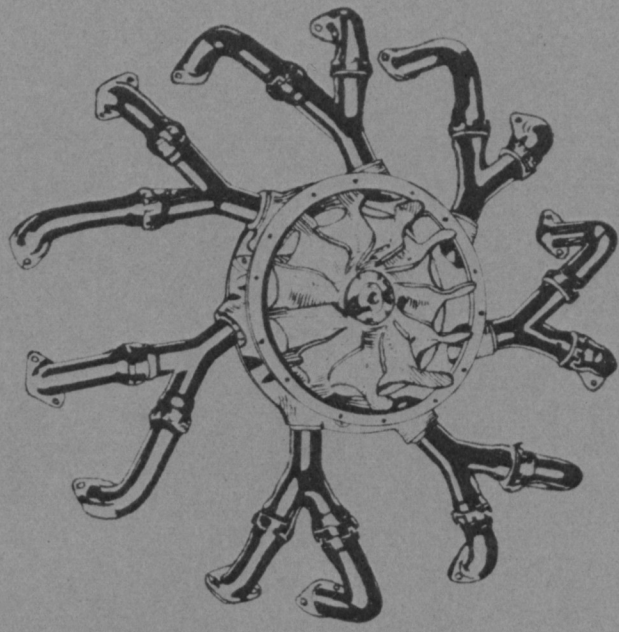

Foon. № 108.

Turbokompressoriga modoni skeem.

- 1 Turbin
- 2 Drossel triinde
- 3 Kõmpressor

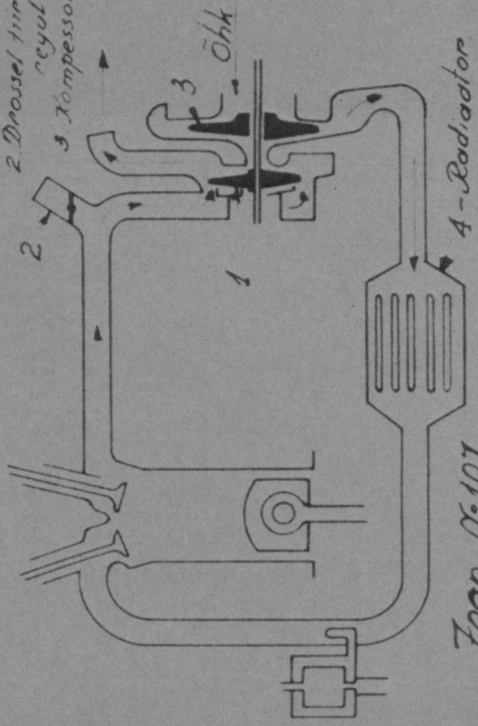

4 - Radiaator

Foon. № 107

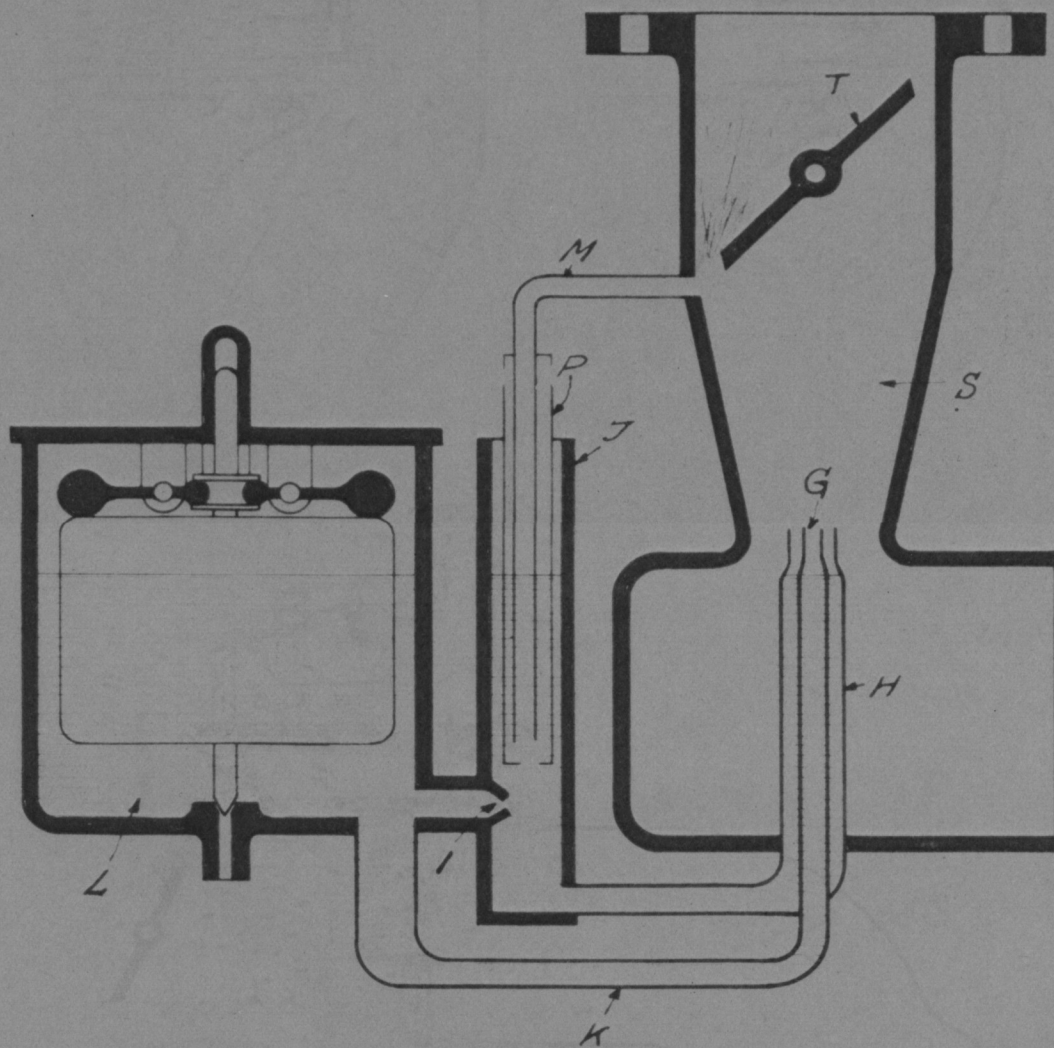

Зон № 109.

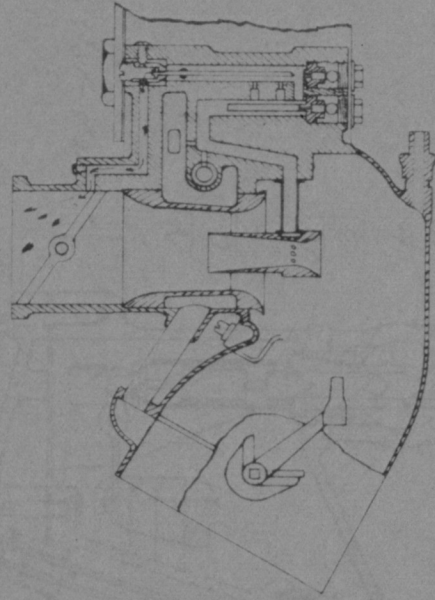
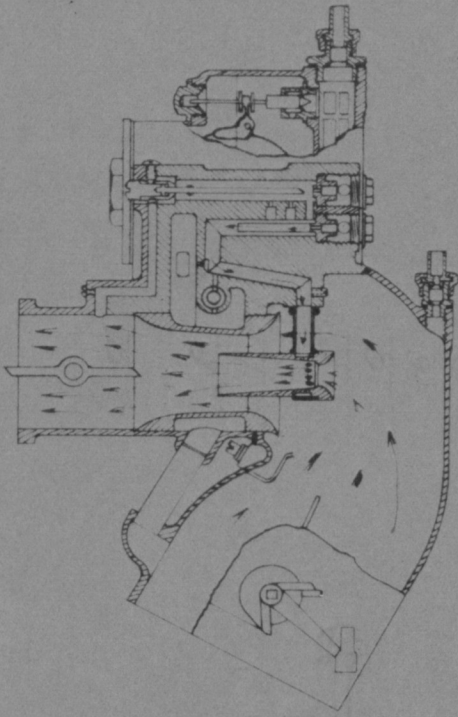

Fig. No. 110

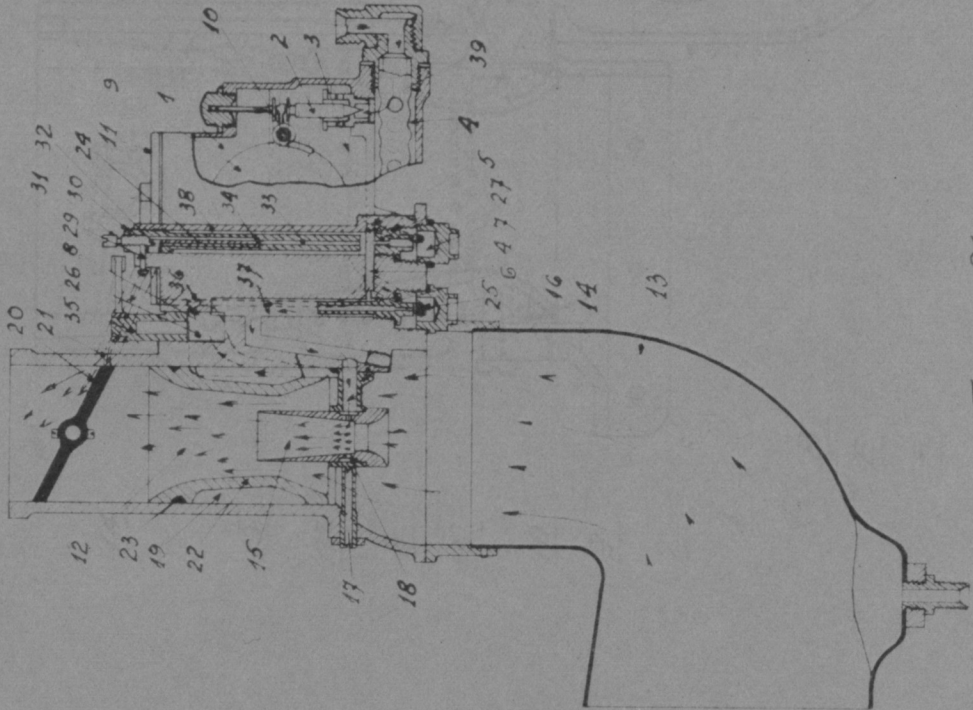
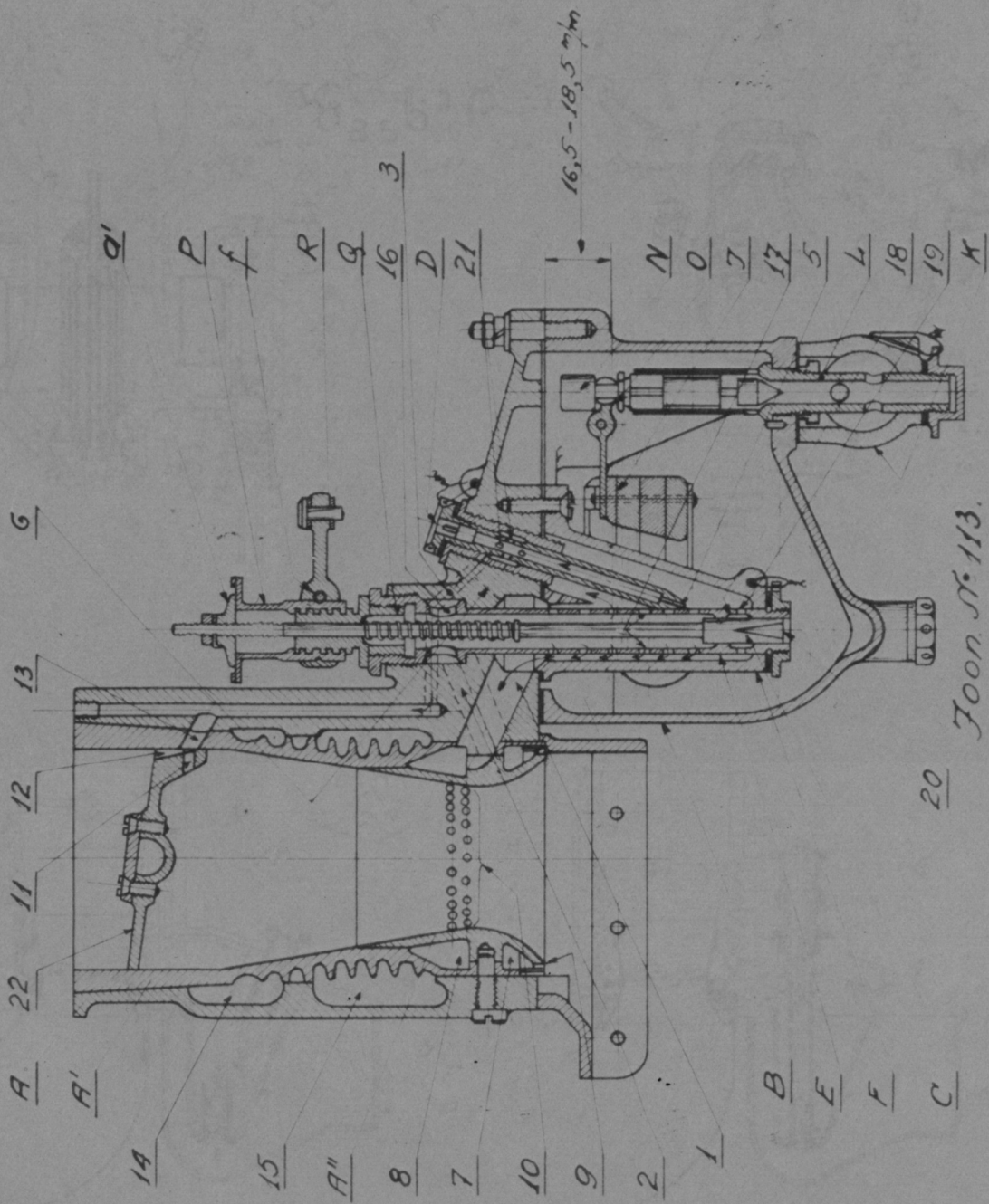
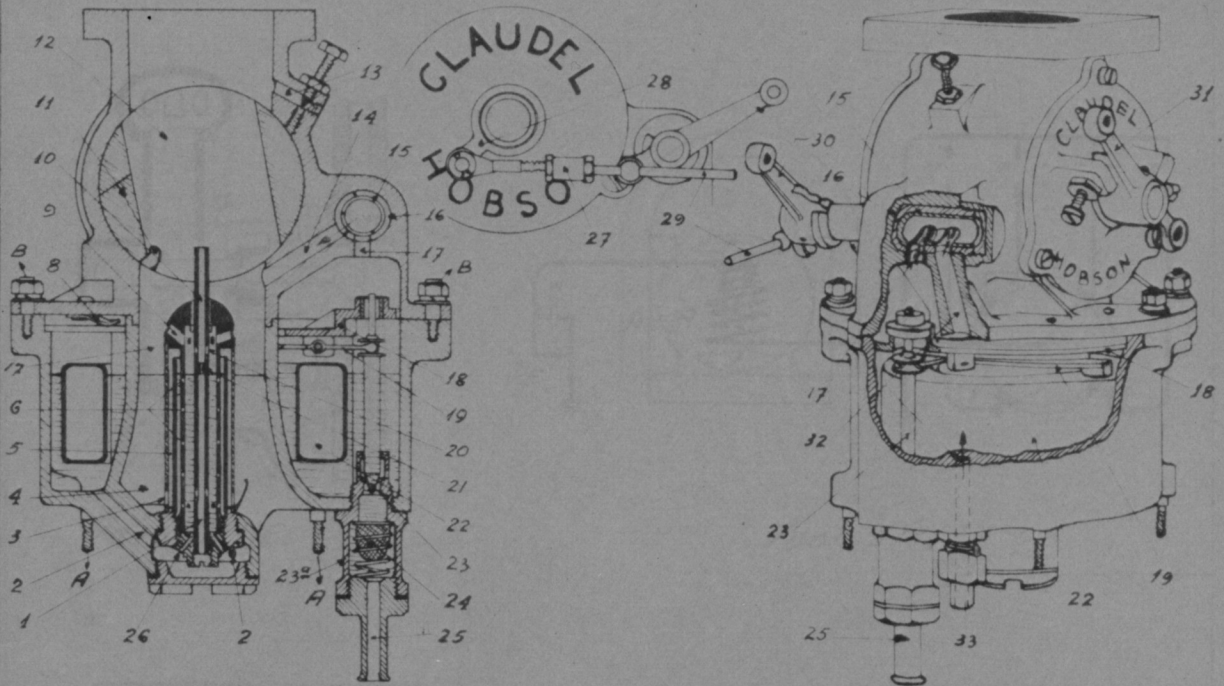

Fig. No. 111



20 *Font. № 113.*



Foon. N: 112

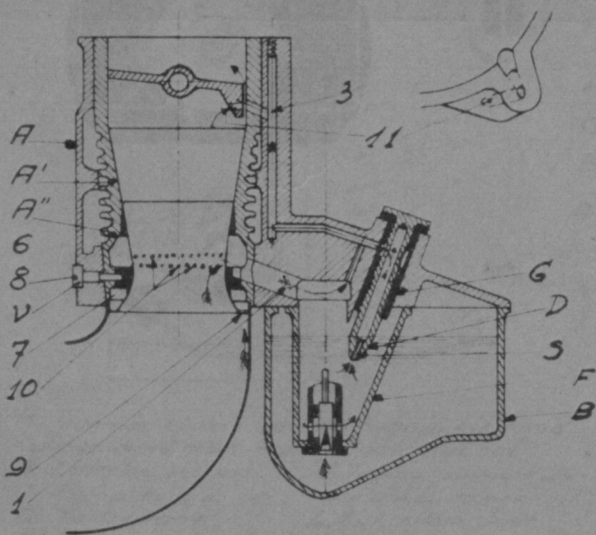

Foon. N: 114

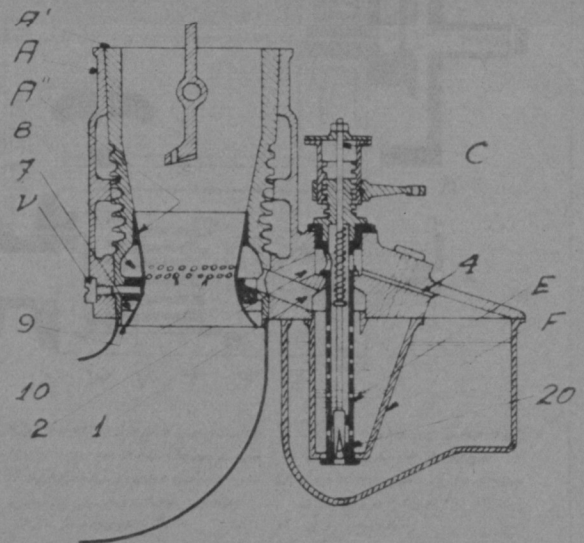

Foon. N: 115

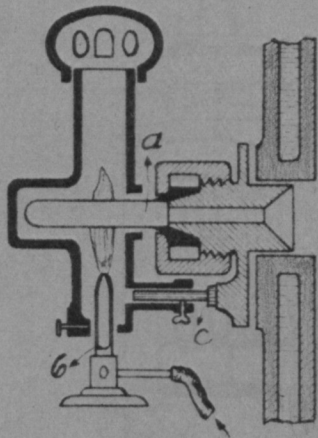

Foon N°116.

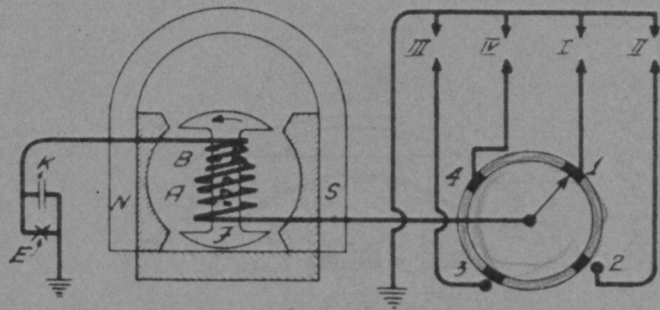

Foon N°117

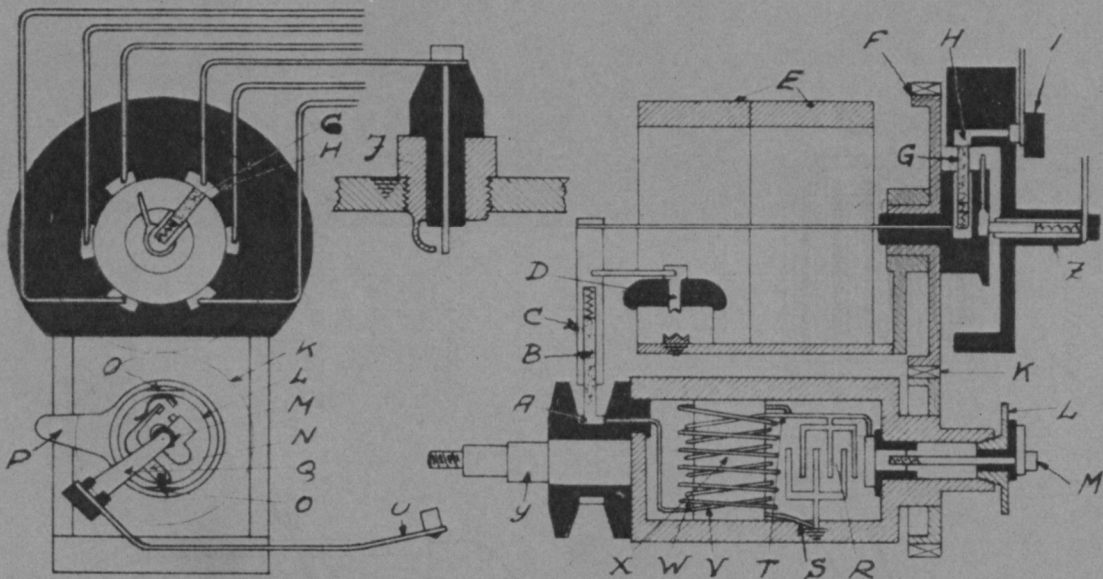

- | | | | |
|---|---|---|--|
| A. Tagamähise isoleeritud otsaga ühend kollek ring. | i. Tagaja klemmid | O. Katkest rõnga segmen. | T. Tagamähise ühendus esimähise külge. |
| B. Kollektori söehari | J. Süüte küünal | P. Süütamise reguleer pide | U. Esimähise lühiühendus kontakt |
| C. Harja hoidja | K. Tagaja hammasröövel ankrü hammasrat | Q. Isoleeritud ühendus esimähise ja kontakt vahel | V. Esimähis |
| D. Kaitse vahe | L. Katkestaja plaat | R. Kondensaator | W. Tagamähis |
| E. Alalised magnetid | M. Ühenduskruvi esimähise otsa ja katkestaja isoleeritud plaadini kontakt vahel | S. Esimähise ja tagamähise ühendus ankrü here, ühes sellega üldise nere külge | X. Ankrü süda |
| F. Tagaja harja kandev hammasratas | N. Xerega ühend kaamer plaatini kontaktiga | | Y. ... võlv |
| G. Tagaja hari | | | Z. Kõimalast magnet |
| H. ... kamellid, sektor | | | |

Foon N°118.

| | | | |
|-------------|-------|-------------|-------------|
| Isola-tioon | Kerge | Madal pinge | Kõrge pinge |
|-------------|-------|-------------|-------------|

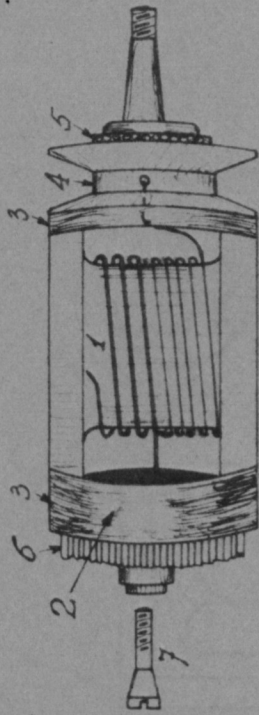

Foot. №122

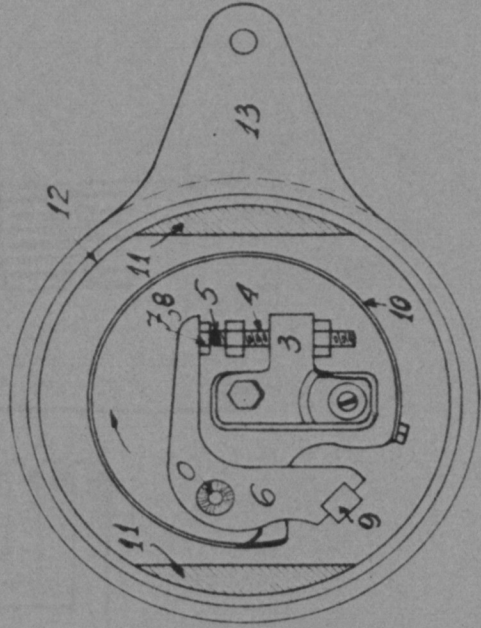

Foot. №124

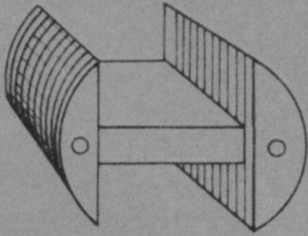

Foot. №121

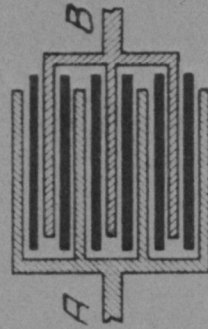

Foot. №123

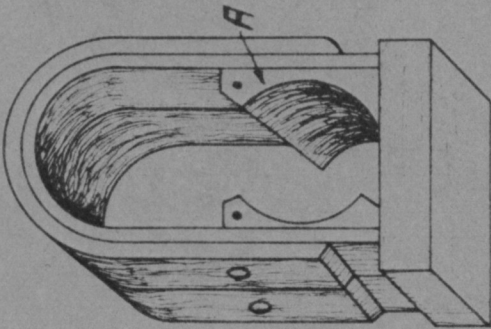

Foot. №119

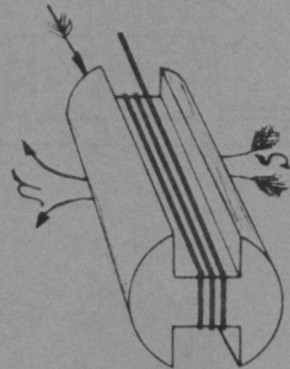

Foot. №120

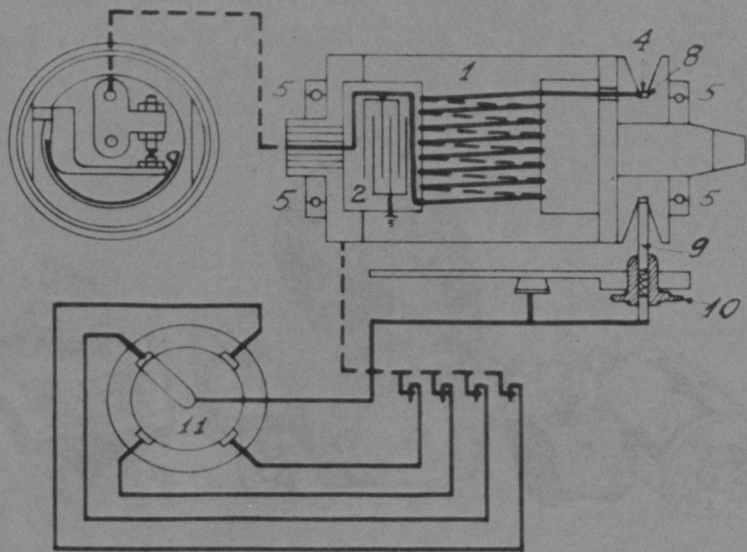

Foon. № 125

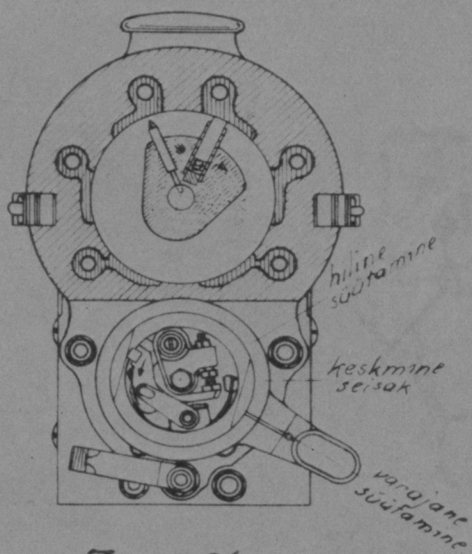

Foon. № 126

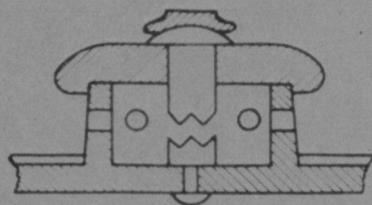

Foon. № 127

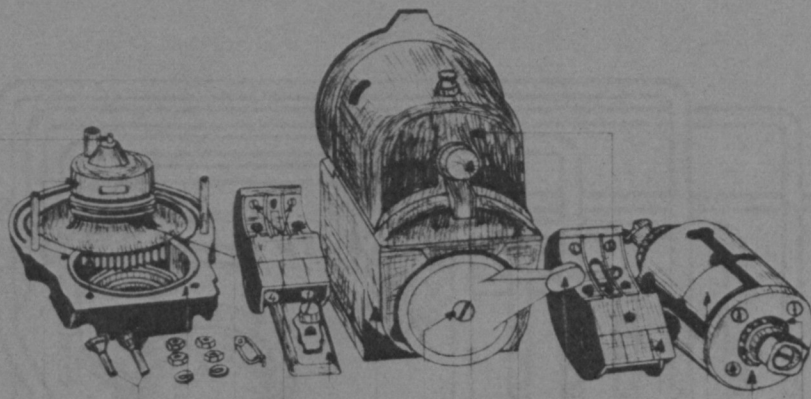

15 32 33 20 50 31 34 24 49 58 16 19 23 56 35 1 5 25

Тоон. №128

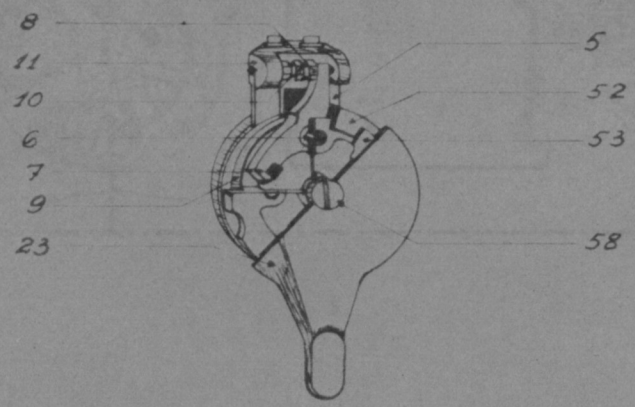

Тоон. №129

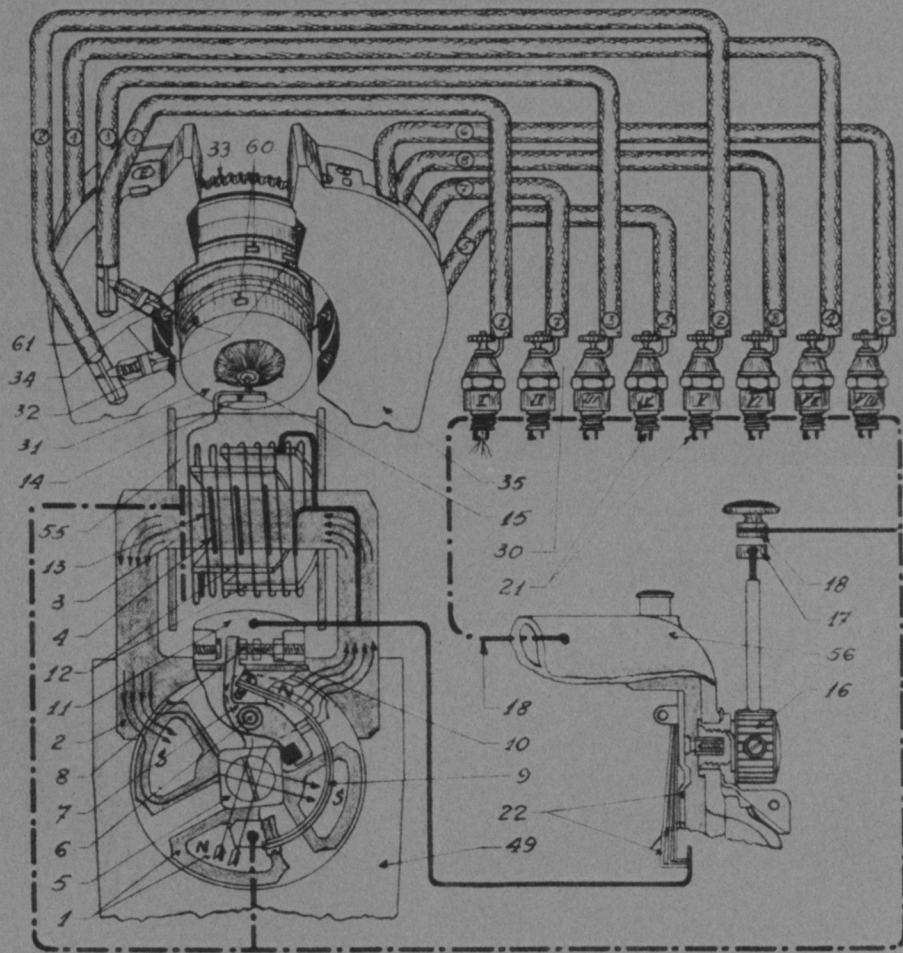

Фон. №130

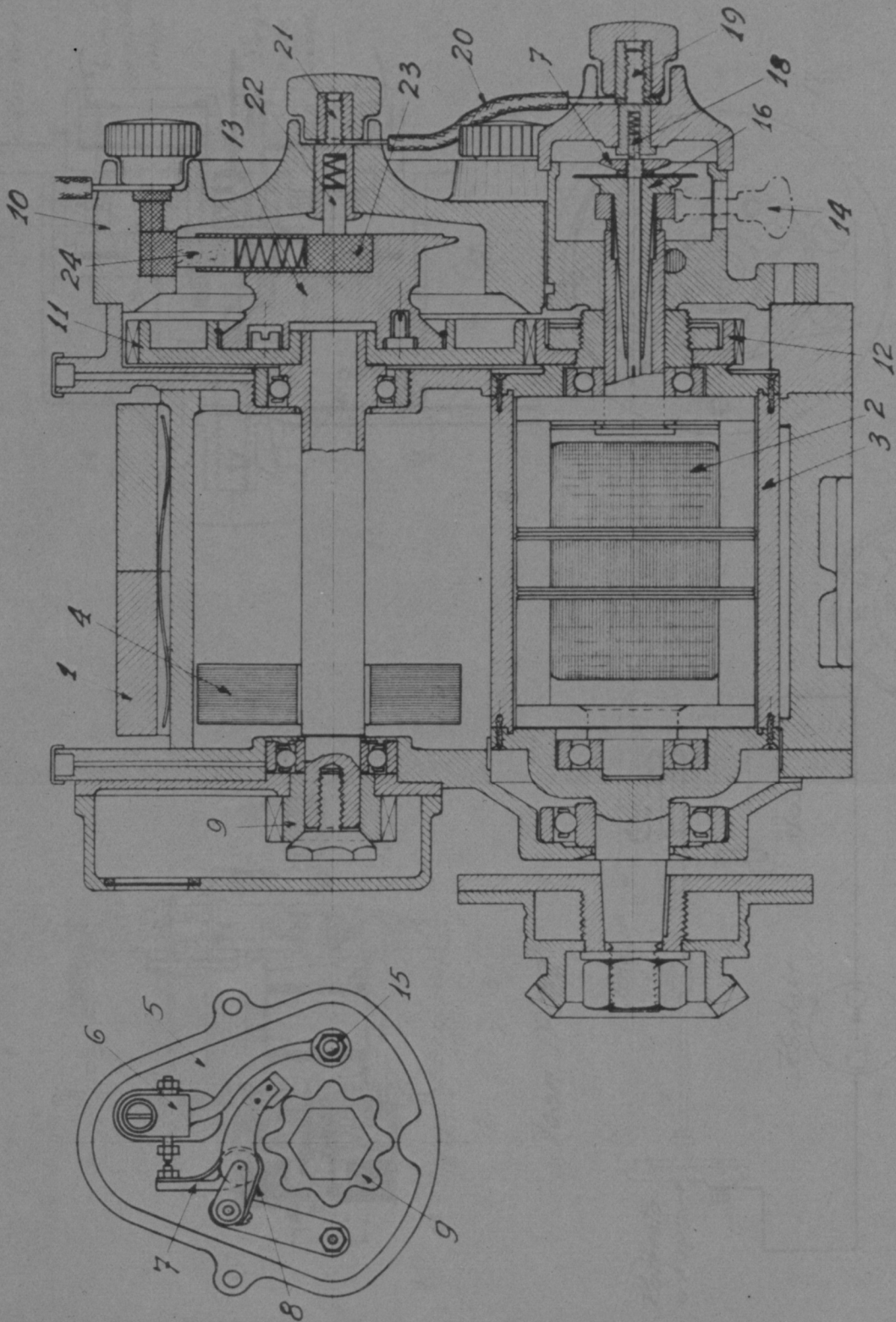

Фон. №131.

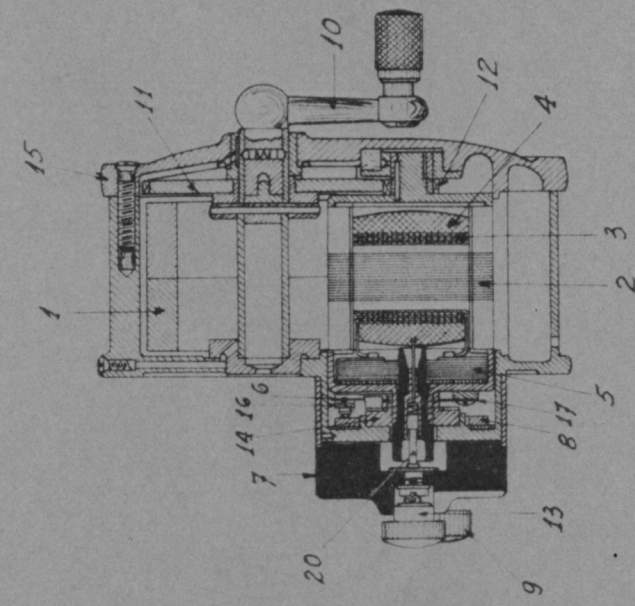

Foon. №132

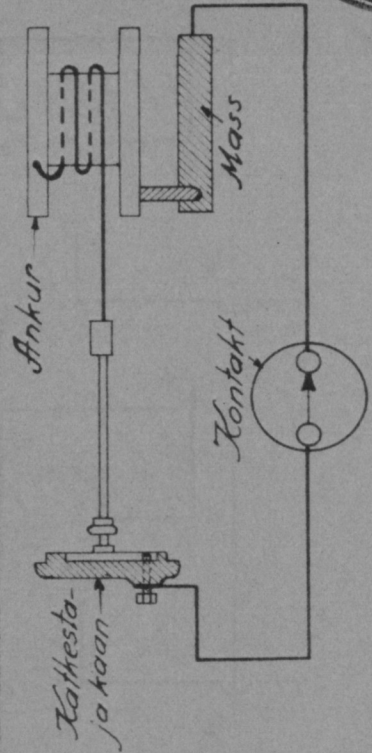

Foon. №134

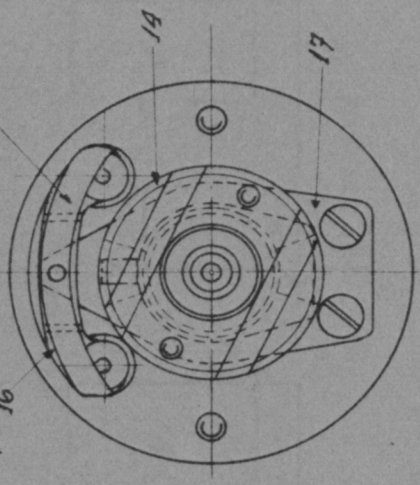
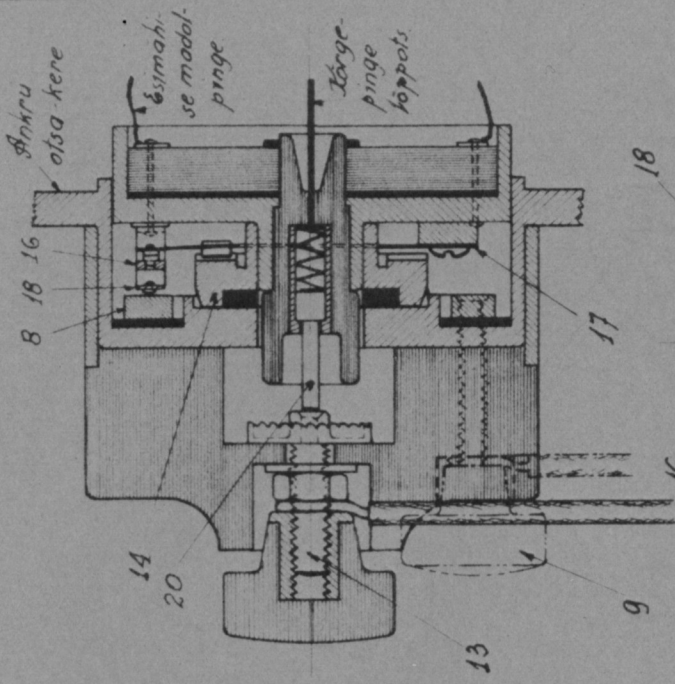

Foon. №133



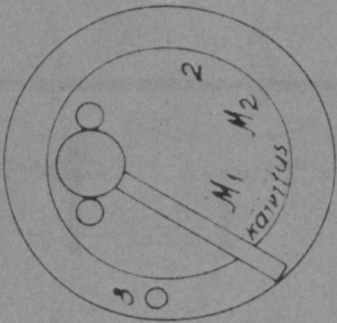

I

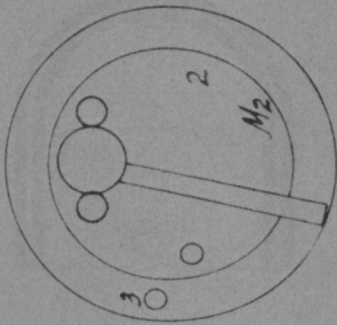

II

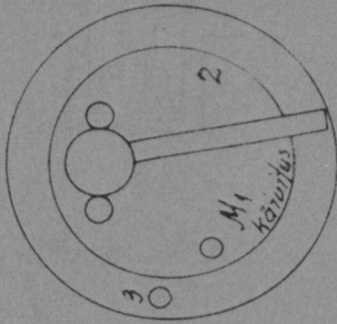

III

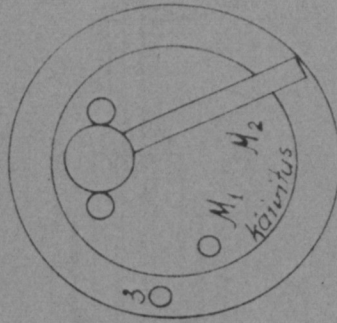

IV

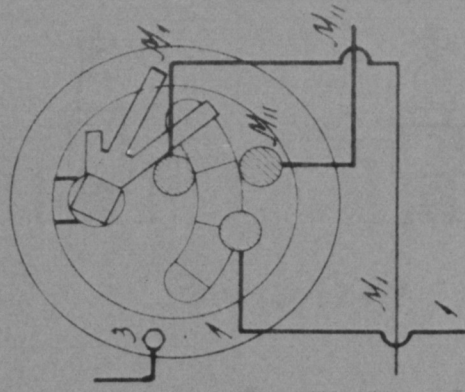
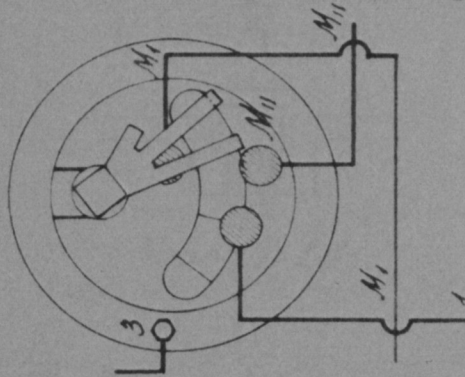
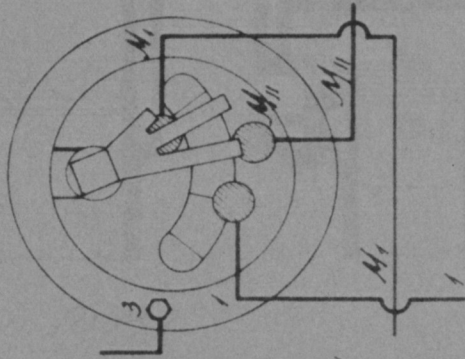
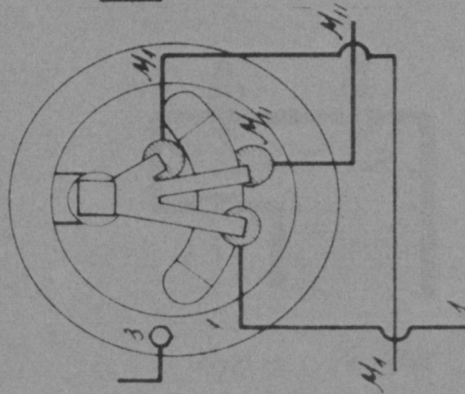

Зон. №135

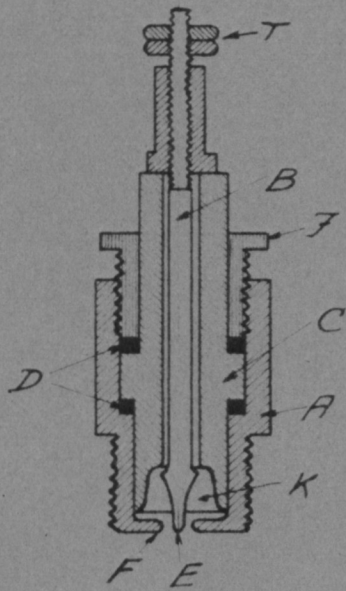

Font. №136

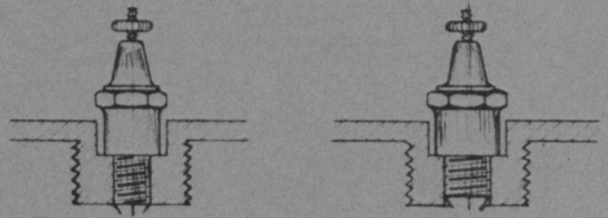

Font. №140

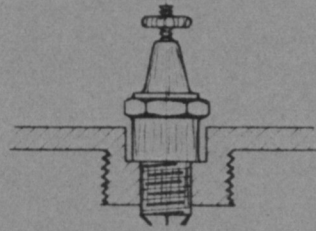

Font. №141

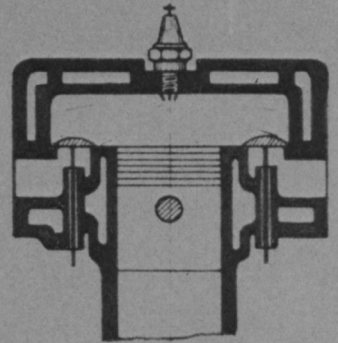
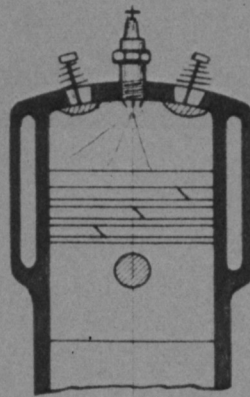
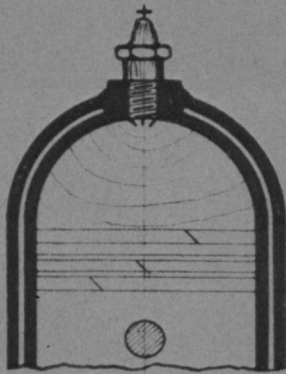

Font. №137

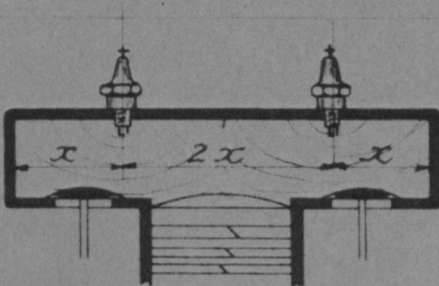

Font. №138

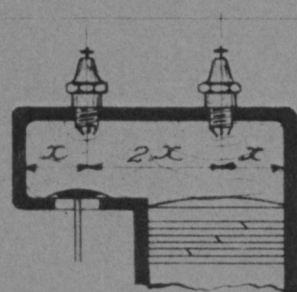

Font. №139

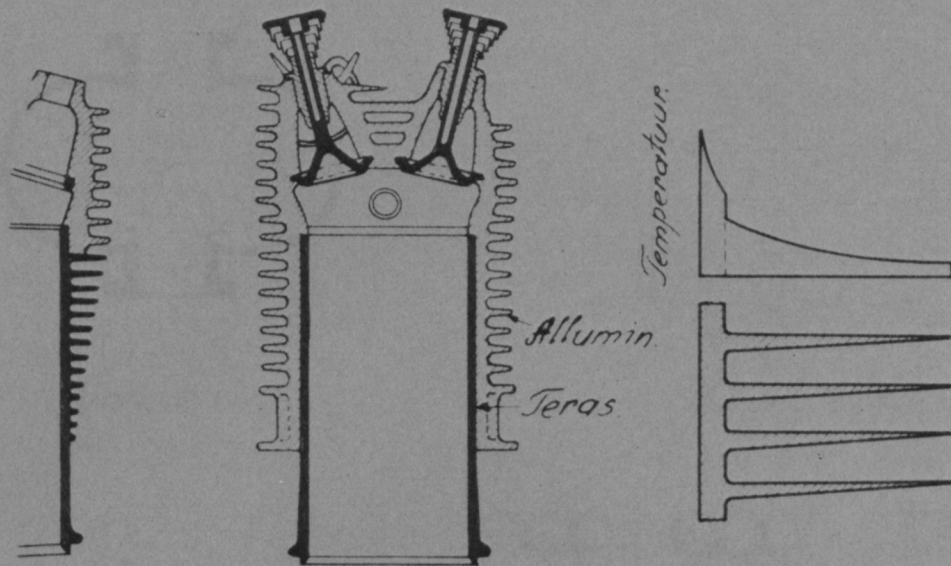

Foon. №143

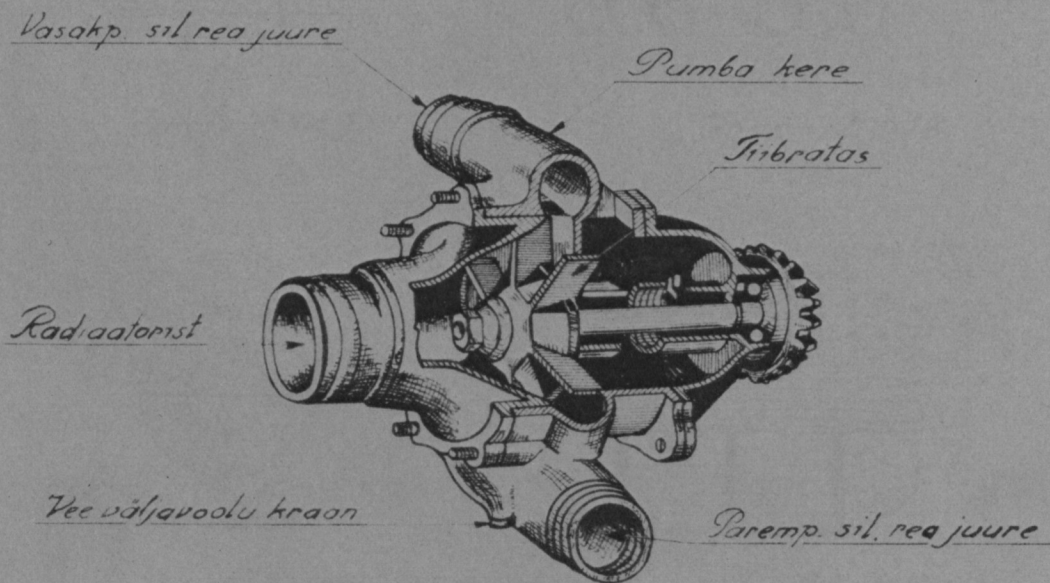

Foon. №144

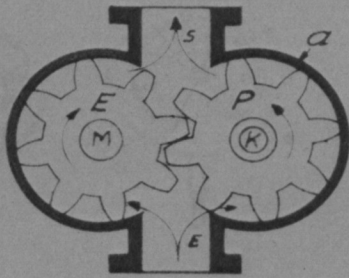

Foon. №145

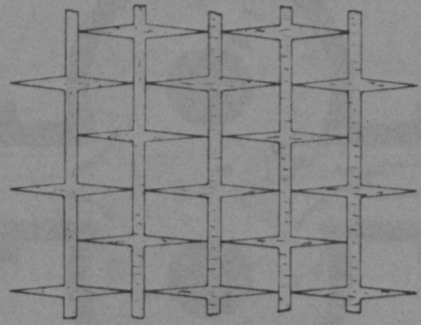

Foon. №146

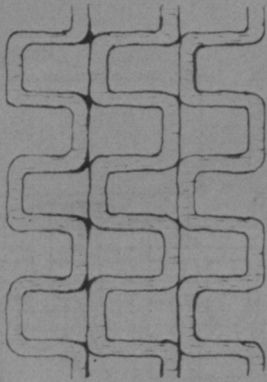

Foon. №147

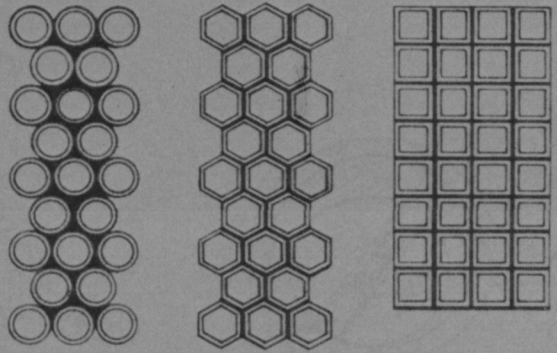

Foon. №148

Bestvaade

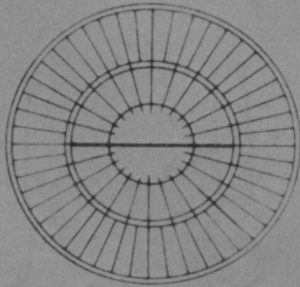

Taqumine

Esimene

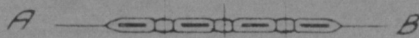
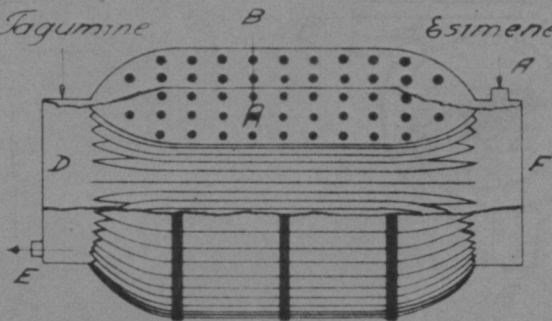

F-õhu sissevool
D-õhu väljavool

Foon. №149

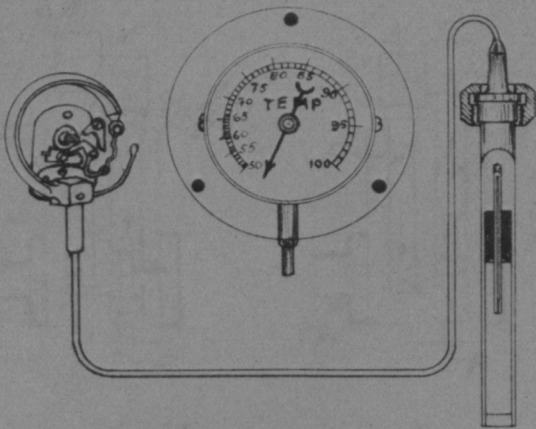

Foan №150

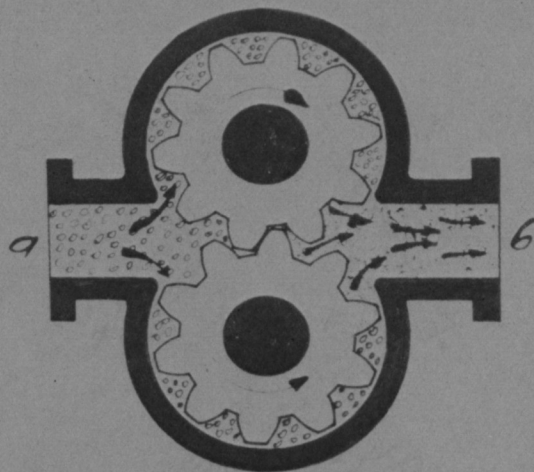

Foan №153

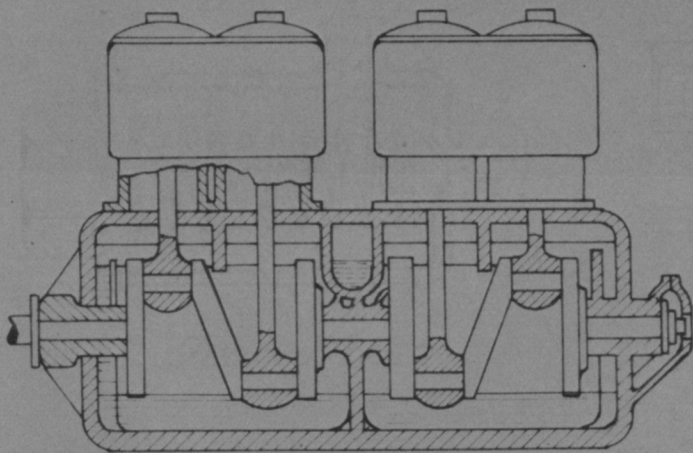

Foan №151

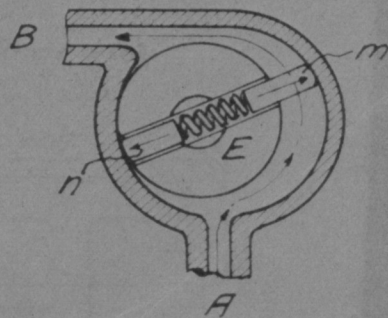
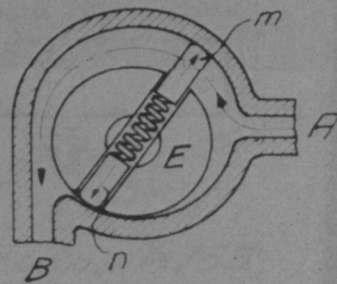

Foan №154

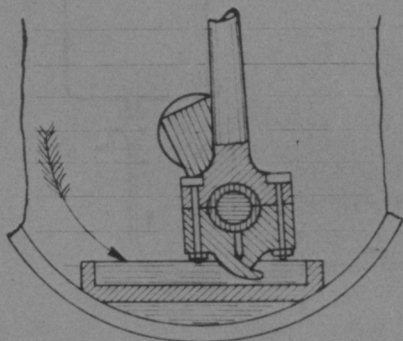

Foan №152

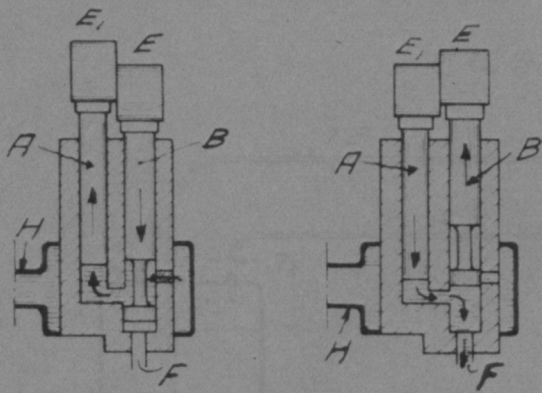

Foon. №155

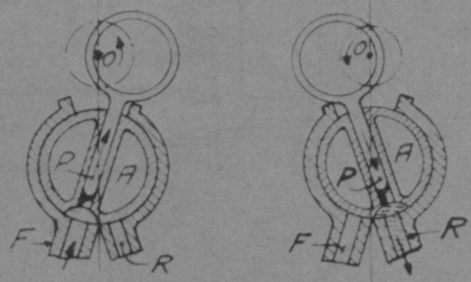

Foon. №156

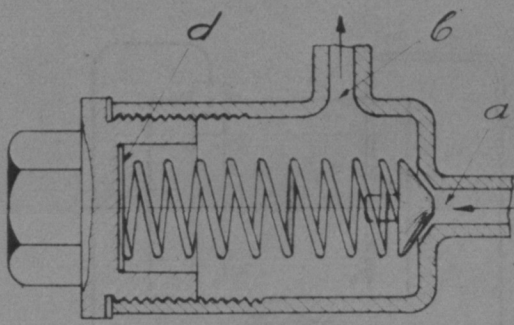

Foon. №157

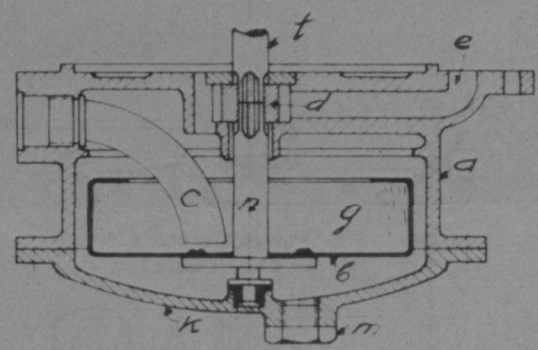

Foon. №158

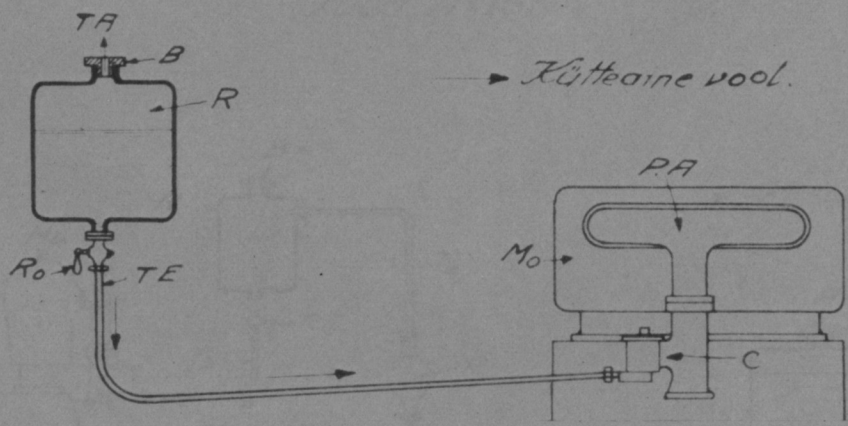

Foon. №159

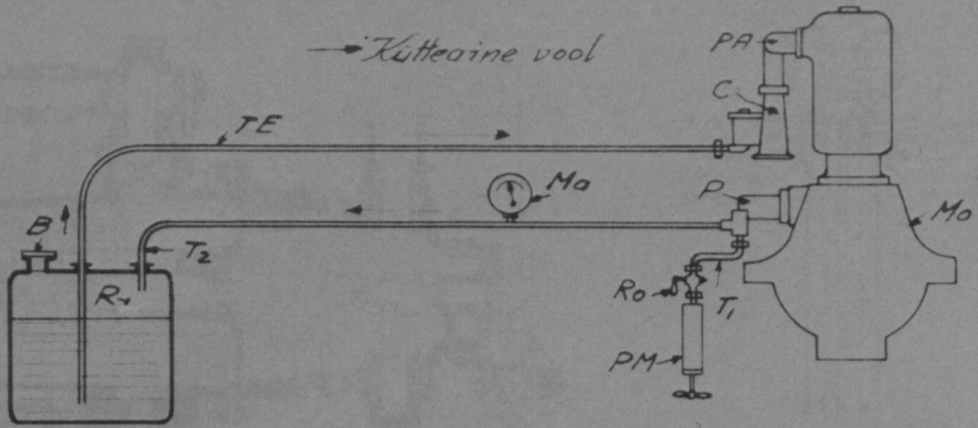

Foon. № 160

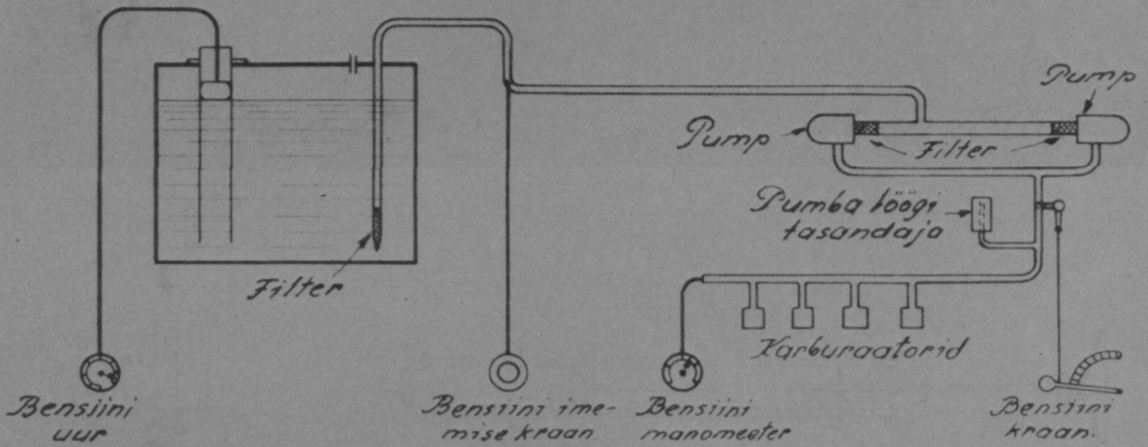

Foon. № 161

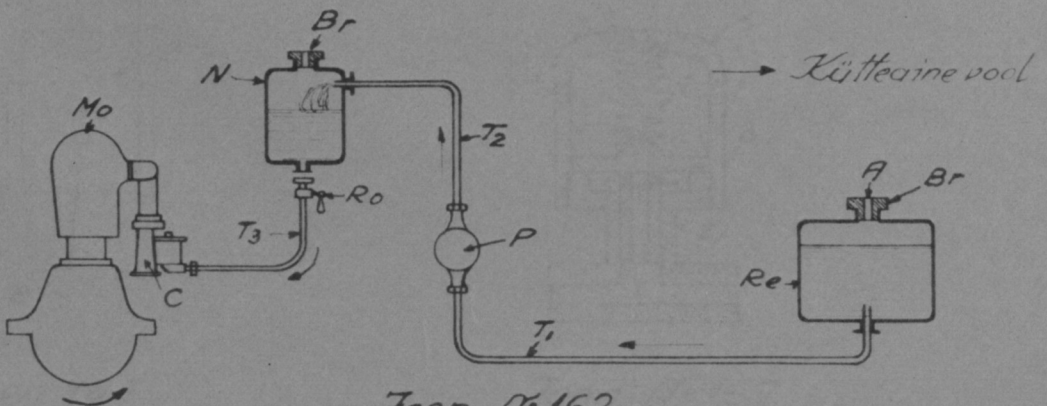

Foon. № 162

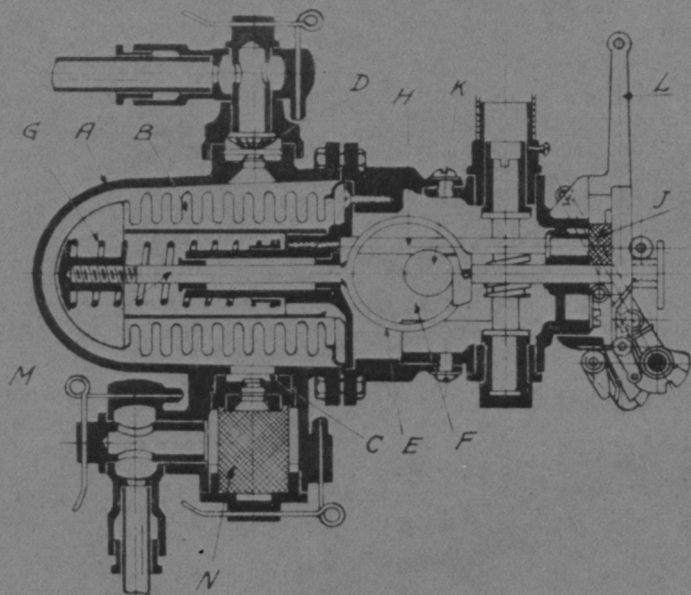

Foon №163

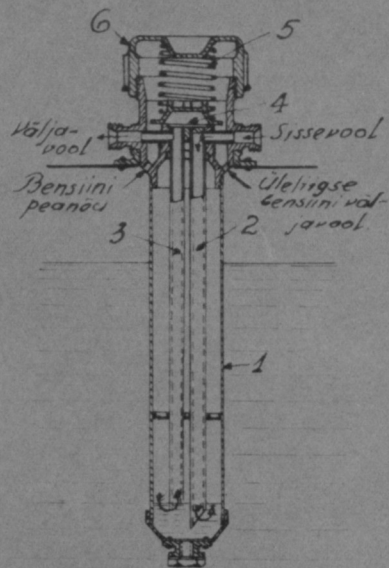

Foon №164

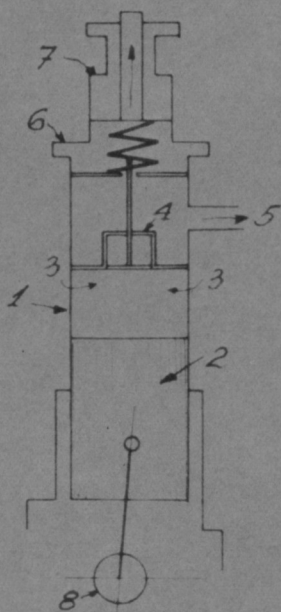

Foon 165

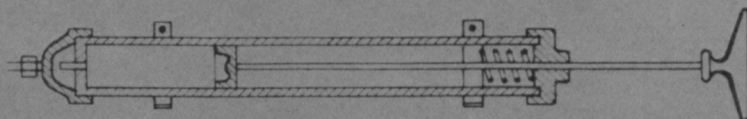

Foon №166

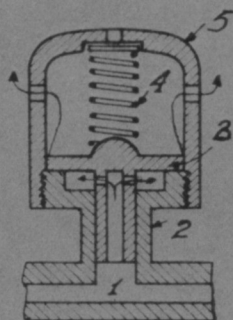

Foon №167

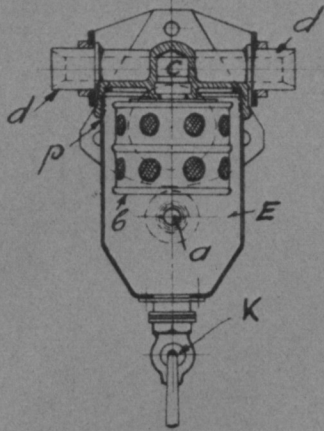

Font. №168

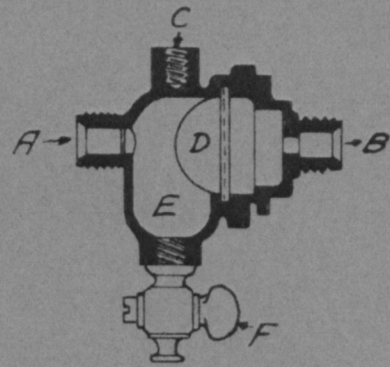

Font. №169

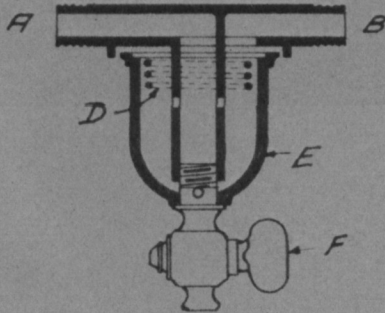

Font. №170

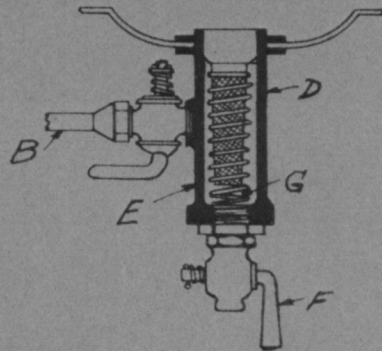

Font. №171

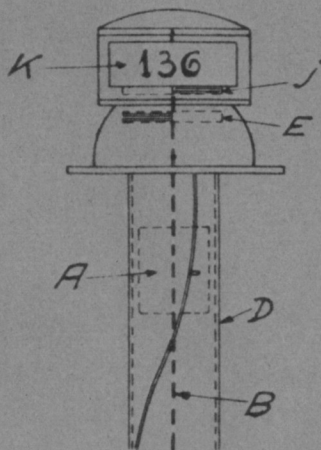

Font. №172

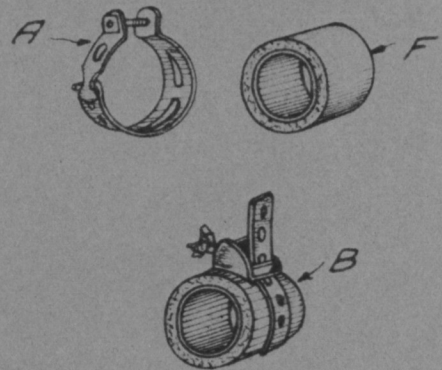

Font. №174

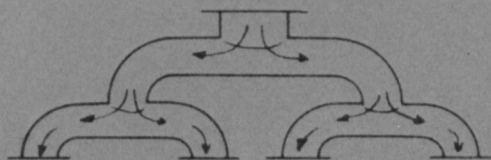
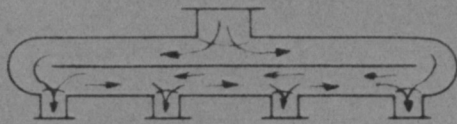
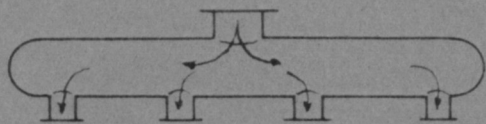

Foon. №173

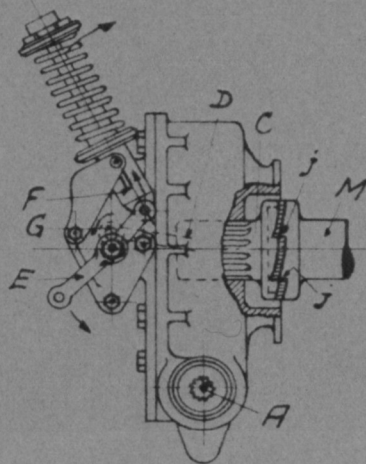

Foon. №175

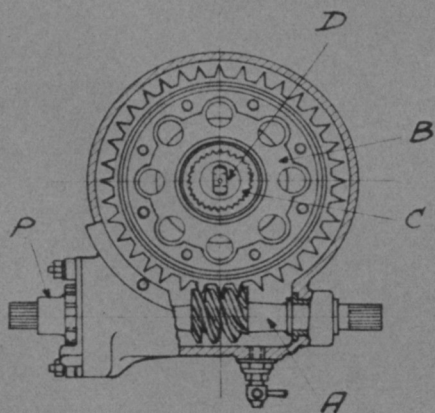

Foon. №176

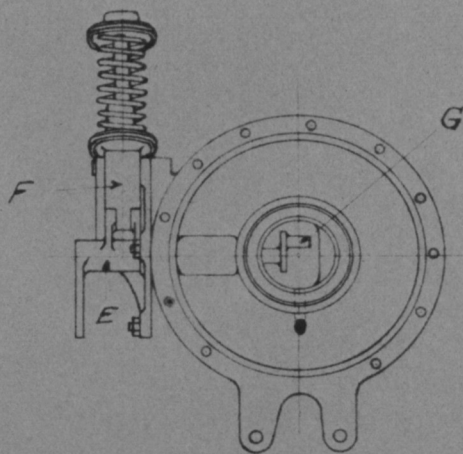

Foon. №177

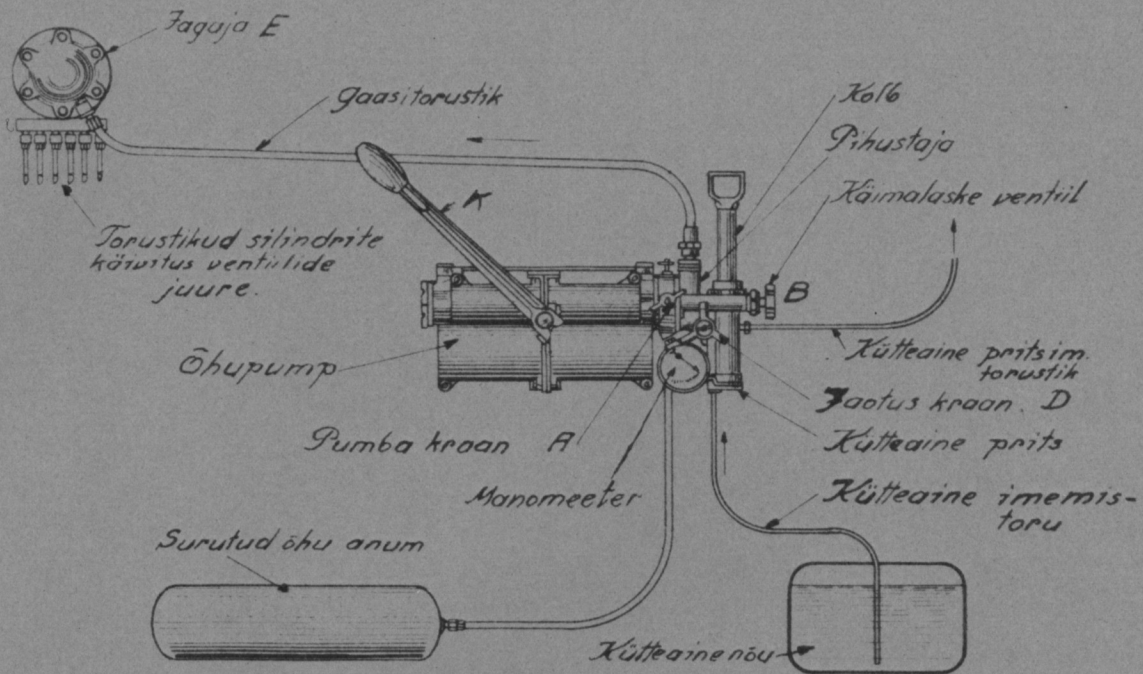

Foon. № 178.

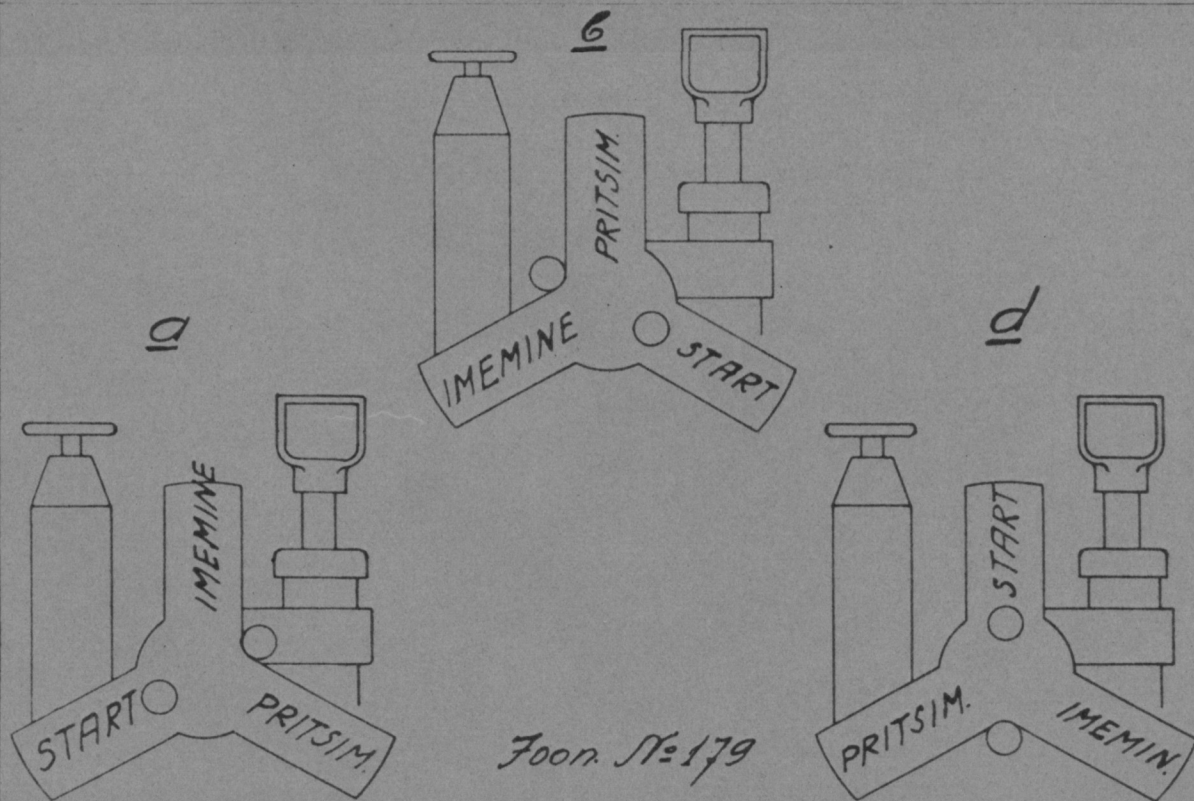

Foon. № 179

KORRATU ÕLITAMINE.

KORRATU ÕLITAMISE VÕIMALIKUD PÕHJUSED

a) TUNNUSED - LIIGA SUUR VÕI ÜLELIHA VAIKE ÕLISURDE.

TUNNUSED

ÕLIMANOMEETER NÄITAB LIIGA SUURE VÕI ÜLELIHA VAIKE ÕLISURDE.



1

ÕLI PÜÜDUS

ÕLI ANUMAS PEAB OLEMA KINDLAKSMÄÄRATUD ARVUL ÕLI

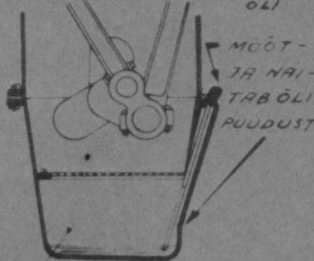

- ALUMINE ANUM

PÕHJUSED

2

ÕLI JUUREVOOLU KRAAN

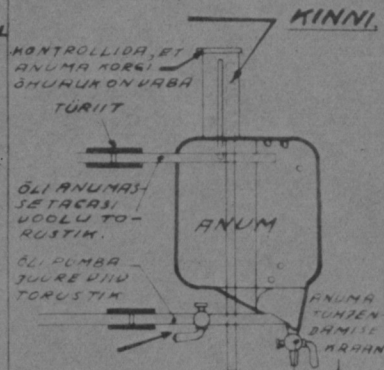

3

FILTRID ON MUSTAD

FILTER ON UMISTUNUD

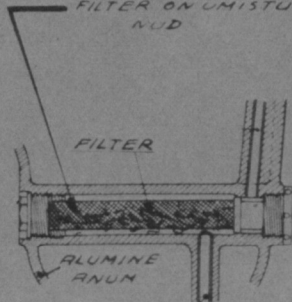

ÕLI PUMBA JUUREST TULEV TORUSTIK

4

PUMP VIIGANE

PUMBA VÕLL KATKI

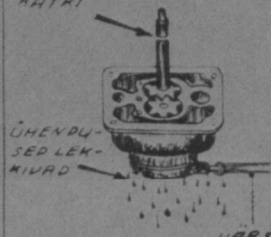

MINGI MEMAANILINERIKKE

VÄRSKE ÕLI JUUREVOOLU TORU

5

TAKISTUSED ÕLITORUSTIKUS

ÜLEMINE ANUM

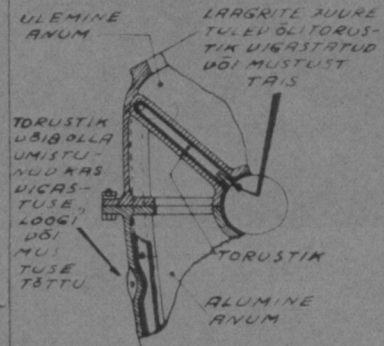

6

ÕLI ON LIIGA SOE VÕI ÜLELIHA KÜLM

ÕLI ÜLELIHA KÜLM, SURDE ON SUUR

TULEB ÕLI SOOJENDADA LASTES MOTOORIL TÕETADA VAIKESTEL TIIRUDEL VÕI TAITA ANUM SOOJA ÕLIGA

ÕLI LIIGA SOE, SURDE ON VAIKE

MOTOOR ON TÕETANUD LIIGA MÄHA ÜHESUGUSTEL TIIRUDEL VÕI TAHTAMINE EI OLE KULLALDANE

7

ÕLI ON LIIGA VEDEL VÕI VANA

LAAGRID ON KULUNUD SURVET EI OLE



LAAGRID KULUNUD, LASEVAD ÕLI LIIGA VABALT LABI, SURVE LANGEB

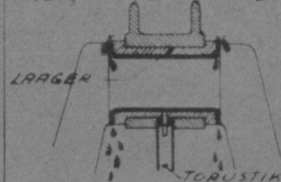

8

KARTERIS ON DETT

ON TINGITUD LEKKIMISTEST VEESÄRKIDE ÜHENDUSTES VÕI NIISKUSE KONDENSEERUMISEST KÜLMAGA

ÕLI KARTERIST VÄLTALASTA

b) TUNNUSED - MOTOOR LÄHEB KUUMAKS VÕI EI SAADUTA NORMAALSET VÕIMSUST.

PÕHJUSED - ÕLI ON HALB VÕI ÕLI RINGPOOL EI TOIMU KORRALIKULT. ÕLI VAHETADA.

d) EBANORMAALNE MÜRA MOTOORI TÕETAMISEL.

NAGU HAKKAKS KÕIK OSAD KINNI TÄRMA MOTOOR VAHETADA.

PÕHJUSED, MILLEDE JÄRELDUSEL MOOTOR TAIELIKULT II
DIAGNOSTADA DÕIB SAADA

KORRATU JAHUTAMINE.

RADIAATOR TÄITA

1 DESTILEERITUD
VÕI VIHMA VESI

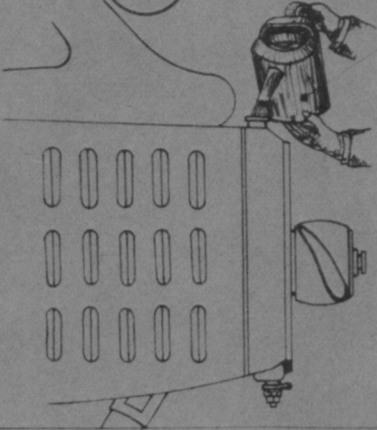

SADESTUSTE
KÕRVALDAMINE.

2



DIAGNOSTUSED TO-
RUSTIKUS.

3

FOOKSEB

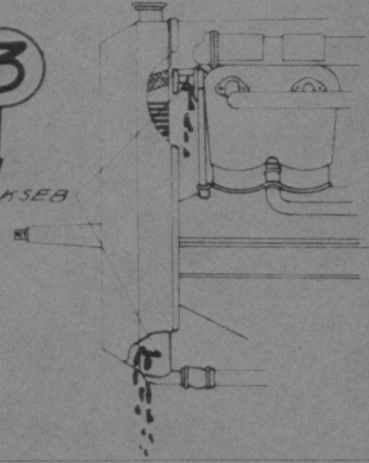

DEEPUMP POLE
KORRAS.

4

DÕLL MUR-
DUNUD

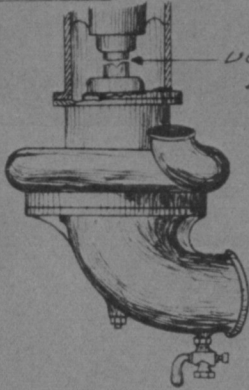

ÕLI ON VÄ-
HE VÕI
HALB ÕLI.

5

ÕLI LENNUKI
MOOTORILE

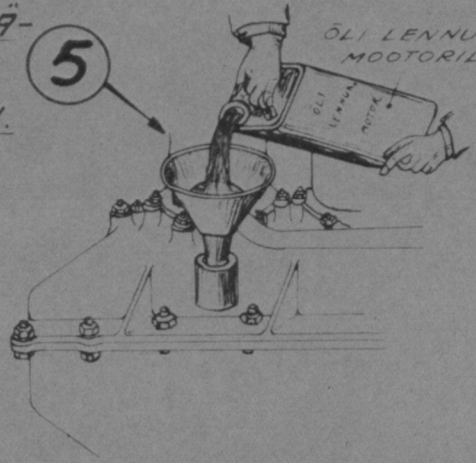

MAGNEETO SÜÜTE KONTROLL.

6

KOLB ON PÕLEVSEGU
SÜTTIMISE PUNKTIS.

KOMMUTAATORI SÜSI
ASUB VASTAVA SILINDRI
JAGAJA LAMELLI VASTAS.

ÕHUKENE PABERI RIBA
VABANEB, PLATINAST
KONTAKTIDE VAHELE
TEKKIB VAHE.

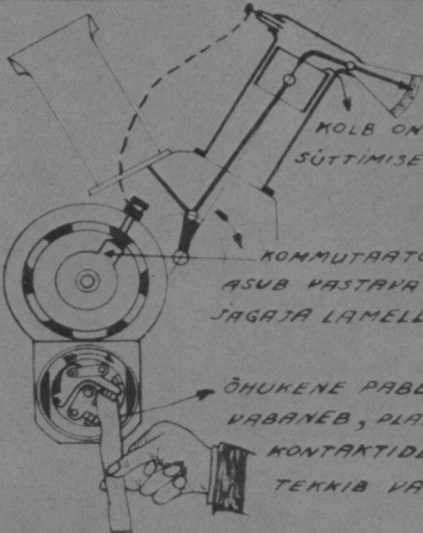

KARBURAATORI REGULEERIMINE.

7

KOMPENSAATOR

PEA PIHUST

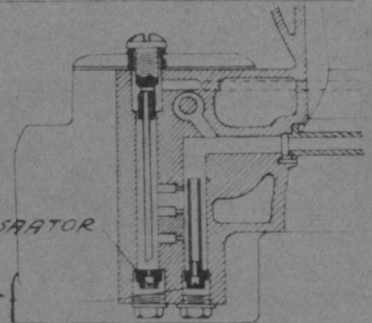

VÄLTJALASKE.

8

SUMBUKATA TAHTMA TAIS

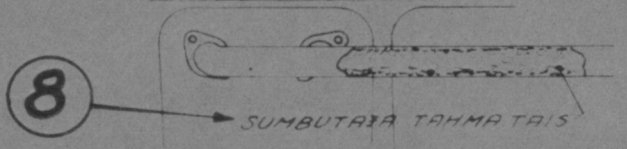

KORRATU SÜÜTAMINE.



SÜÜTAMINE MAGNEETOGA

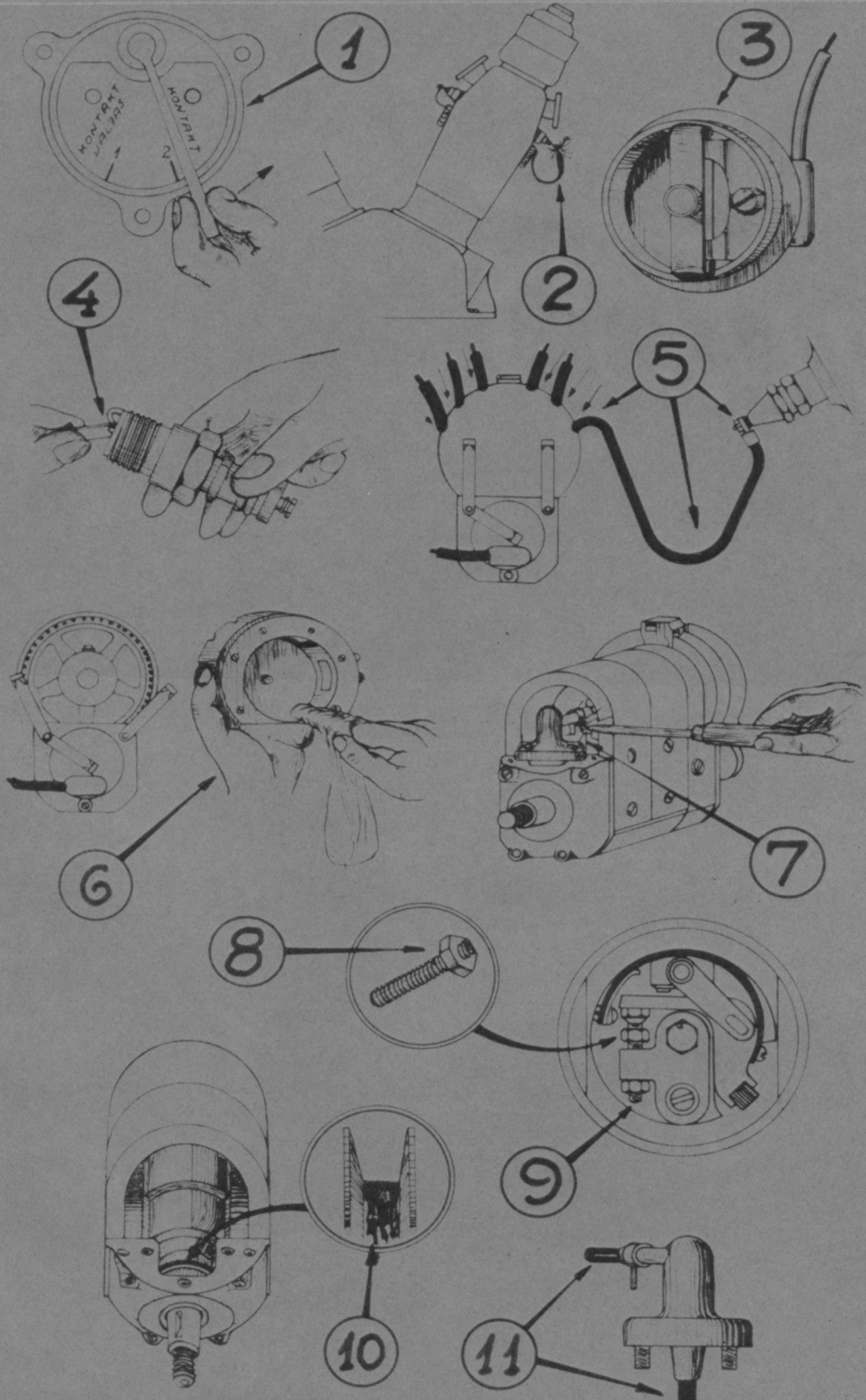

KARBURATSIOON, KÜTTEAINE JUURDEVOOL.

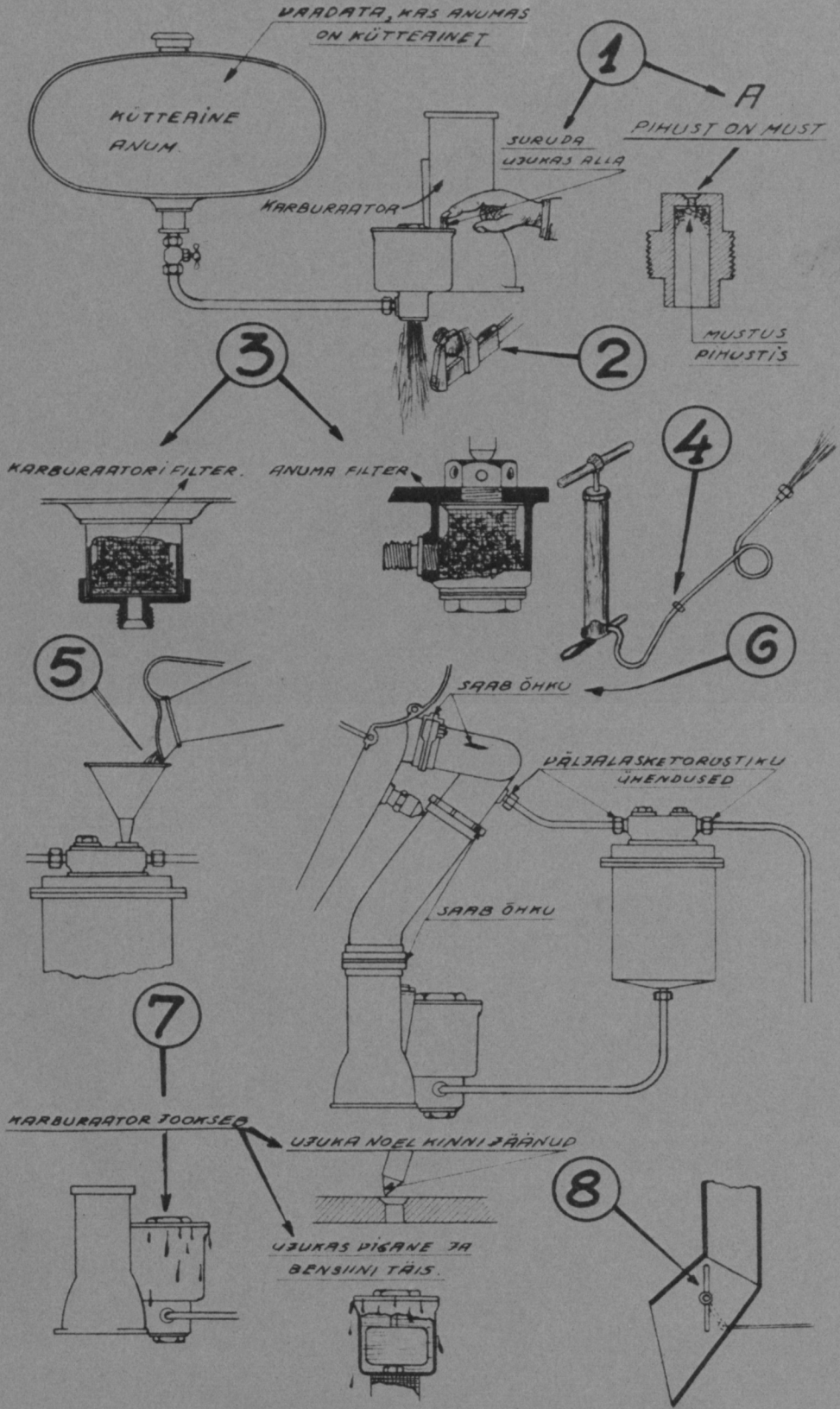

HALB KOMPRESSI00N

V

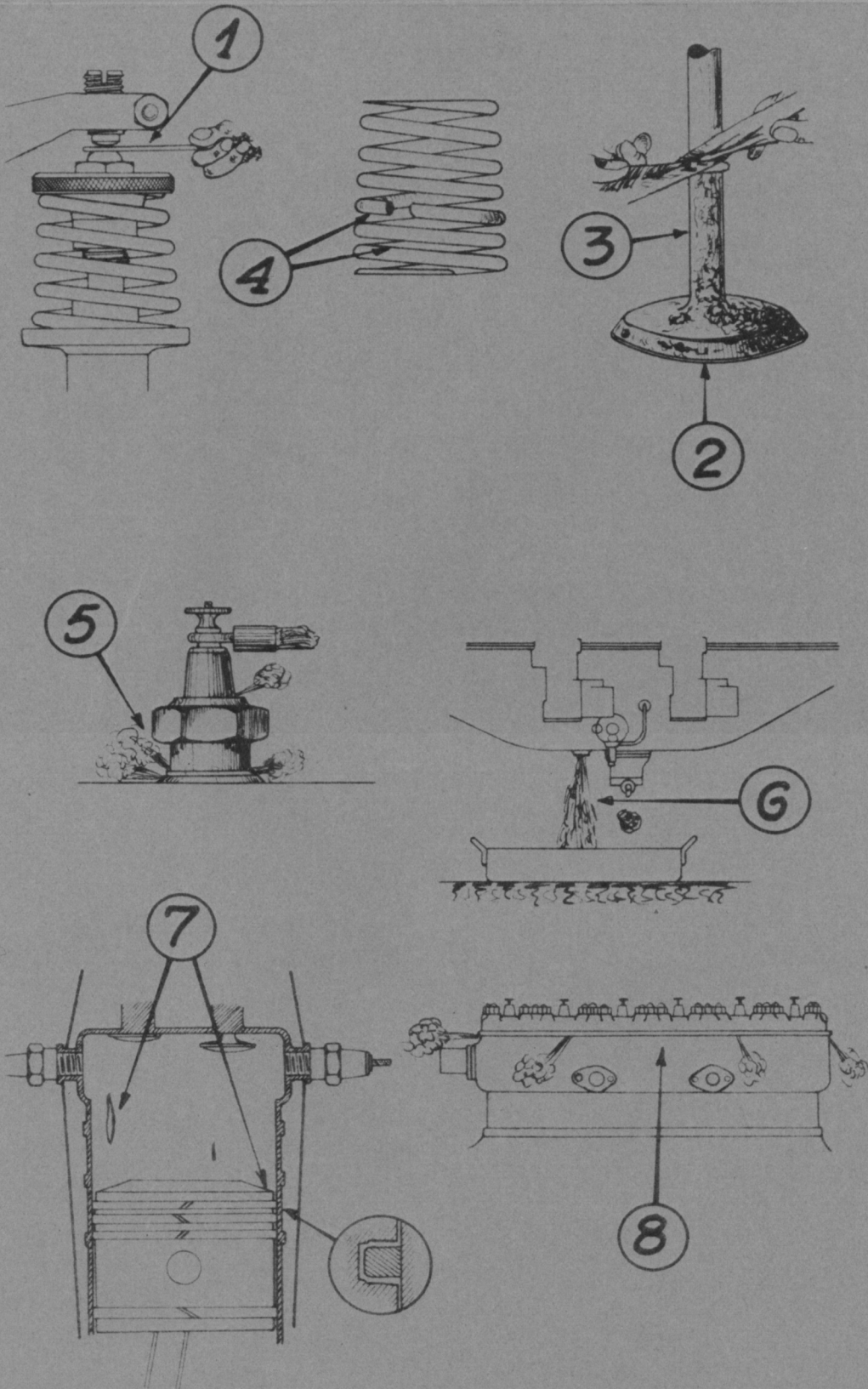

MOOTOR EI LÄHE KÄIMA.

A.-KORRATUS KÜTTEAINE JUUREDOOLUS JA KARBURATSIOONIS.

a.) KÜTTEAINET EI DOOLA UJUKI KAMBRISSE.

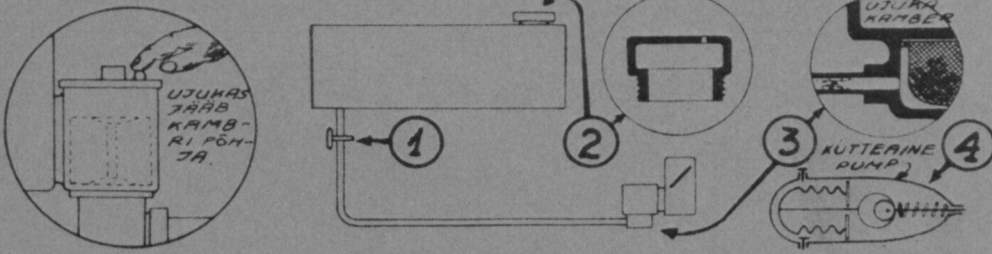

b.) KÜTTEAINET DOOLAB UJUKI KAMBRISSE KUID EI TULE PIHUSTITESSE

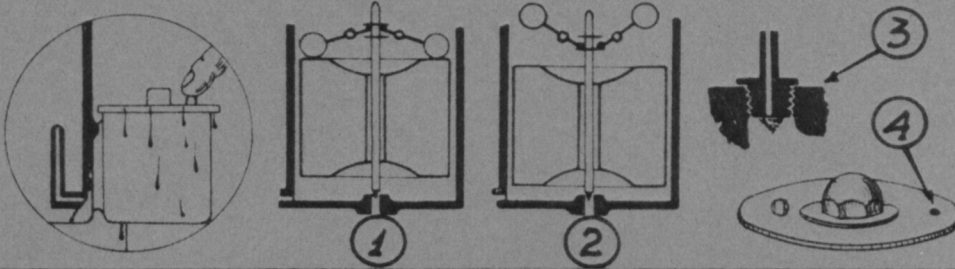

d.) KÜTTEAINET DOOLAB ÜLIPALJU PIHUSTITESSE

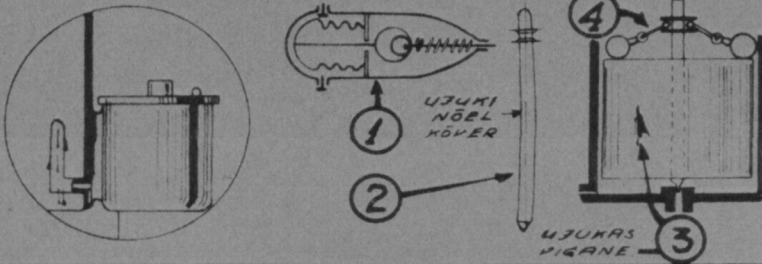

e.) KARBURATSIOON

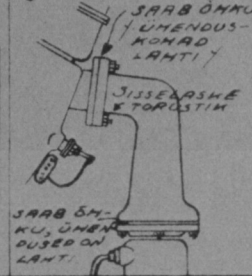

B.-SÜÜTAMINE -KONTROLLIDA SÄDEME TEKKIMIST JAGAJA SÖÖL

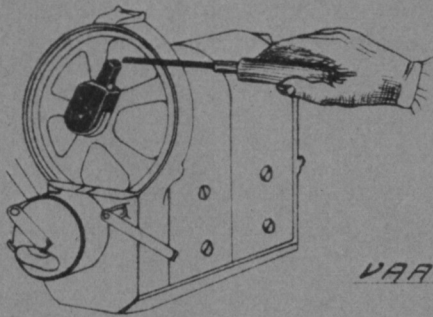

ÜHENDADA MAGNEETO KÕRPU POORLEVA SÖÖGA / MÄRITAGI JÄTTES UM-
BES 2 mm VAHE JA KEE-
RATA MOOTORIT KÄSITSI.

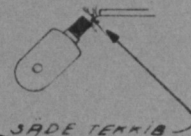

VARTA DEAD MAGNETOS.



D.-KOMPRESSIOON.

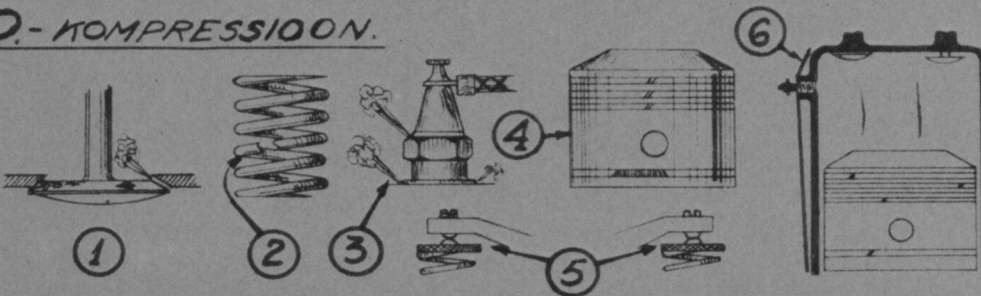

MOOTOR JÄTAB VAHELE.

ÜKS VÕI MITU SILINDRIT JÄTAVAD VAHELE VÕI
EI TÖÖTA ÜLDSE MITTE.

A. KORRATU KÜTTEAINEJUUREPOOL VÕI KARBURATSIOON

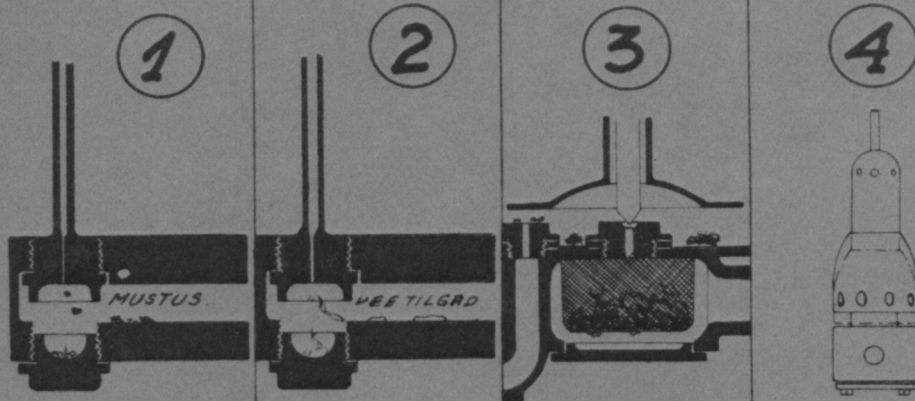

B. SÜÜTAMINE

VAATA MAGNEETO DEAD

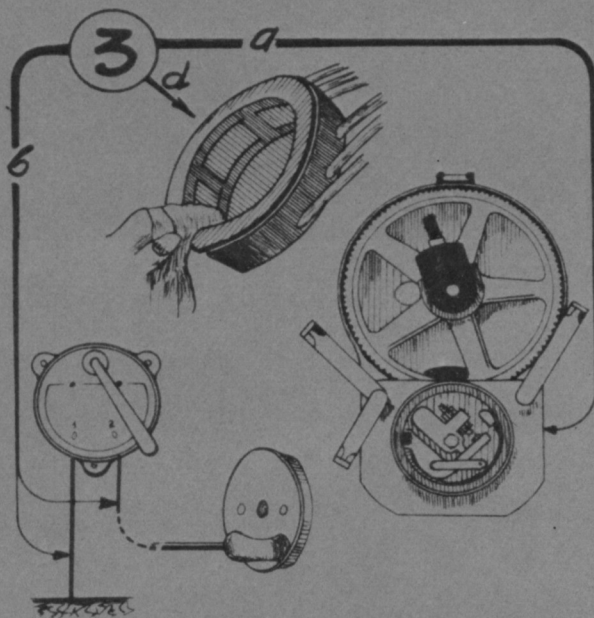
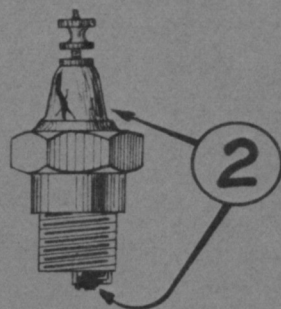
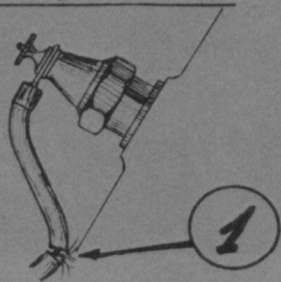

D. JAGAMINE.

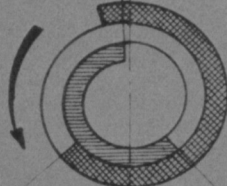
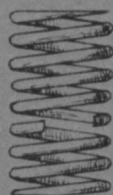
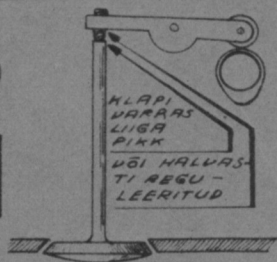
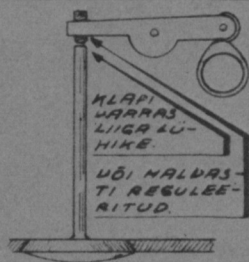

1

2

3

4

MOOTOR EI SAADUTA NORMAAL- SET DÕIMSUST

VIII

KARBURATSIOON



A

SÜÜTAMINE

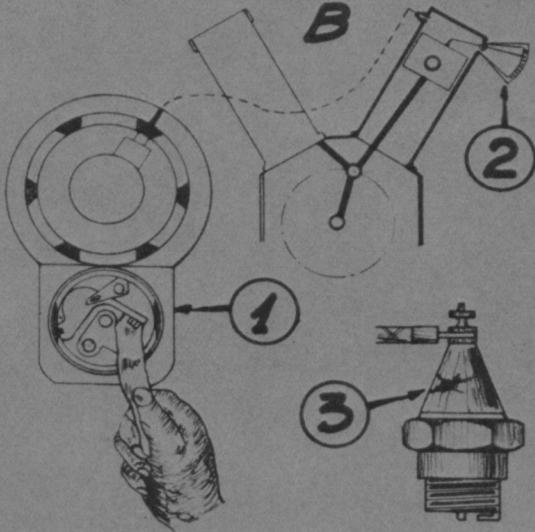

B

JAGAMINE

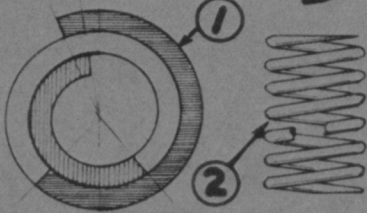

D

JAHUTAMINE

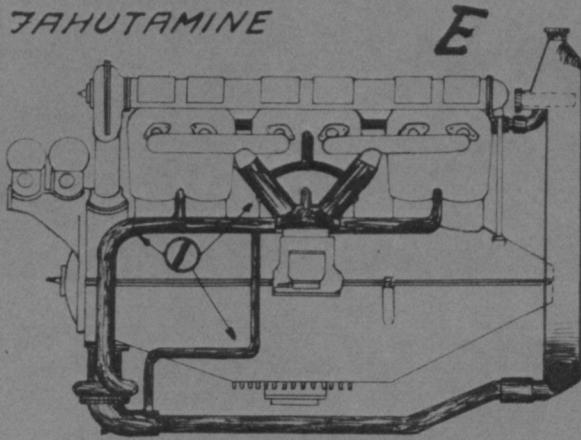

E

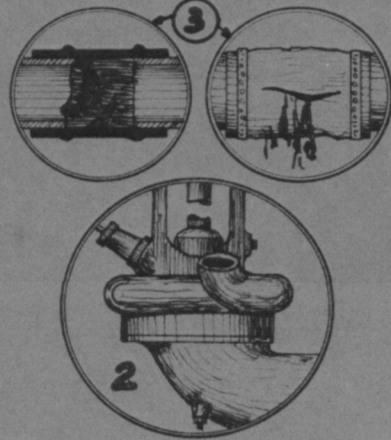

ÕLITUS

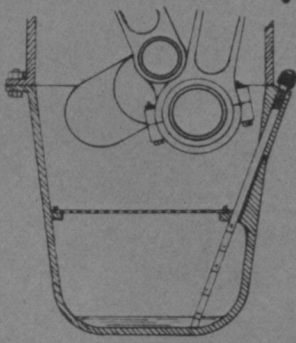

F

KOMPRESSION

- KLAPID KINNIAARNUD
- HALVASTI LIHMITUD KLAPID
- KATKISED VEHRUD
- OPRAALSED SILINDRID
- KRIINUSTUSED SI-LINDRIS
- OPRAALSED KOLVID
- KRIINUSTUSED KOLVIL
- KOLUNUD KOLVI RÕNGAD
- HALVASTI ASETUD KOLVI RÕNGAD
- KATKISED KOLVI RÕNGAD

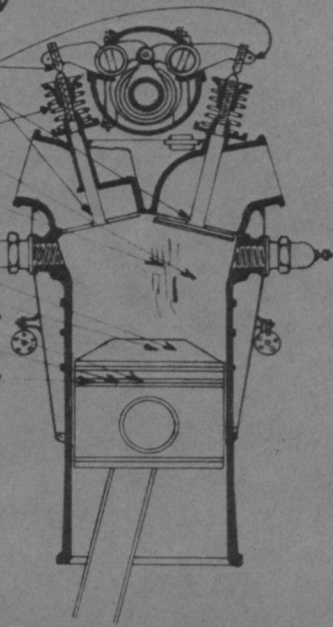

G

VÄLJALASKE.



H

Ar 935

Mootoriteaduse

2.