



EESTI VABARIIK

**T** **EESTI**  
**TÖÖSTUSDISAINI-**  
**LAHENDUSE LEHT**



PATENDIAMETI AMETLIK VÄLJAANNE

**4**  
**2003**  
TALLINN

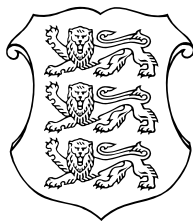

ISSN 1406-376X

EESTI VABARIIK

**T** **EESTI**  
**TÖÖSTUSDISAINI-**  
**LAHENDUSE LEHT**

**PATENDIAMETI  
AMETLIK VÄLJAANNE**

**VI aastakäik**

**Käesolevas numbris  
esitatud andmed  
loetakse avaldatuks  
17. novembril 2003. a.**

**4**  
**2003**  
NOVEMBER  
TALLINN

Eesti Tööstusdisainilahenduse Lehte antakse välja tööstusdisaini kaitse seaduse (jõustunud 11.01.1998) alusel.  
The Estonian Industrial Design Gazette is the official publication of the Estonian Patent Office.  
Published under Industrial Design Protection Law of the Republic of Estonia (coming into force 11 January 1998).  
Date of publication of the data presented in this issue - 17 November 2003.

Patendiameti  
infoosakond  
Toompuiestee 7  
15041 Tallinn  
Tel. 627 7907  
Faks 627 7943  
E-post: Info@epa.ee

The Information Department  
of the Estonian Patent Office  
Toompuiestee 7  
15041 Tallinn, ESTONIA  
Phone (372) 627 7907  
Fax (372) 627 7943  
E-mail: Info@epa.ee

Levitaja

Eesti Patendiraamatukogu  
Olevimägi 8/10  
10123 Tallinn  
Tel. 641 1248  
Faks 641 1018  
E-post: patent@patentlib.ee

Distributor

Estonian Patent Library  
Olevimägi 8/10  
10123 Tallinn, ESTONIA  
Phone (372) 641 1248  
Fax (372) 641 1018  
E-mail: patent@patentlib.ee

## SISUKORD

Andmete identifitseerimise rahvusvahelised numberkoodid (INID-koodid) . . . . .	4
I. REGISTREERITUD TÖÖSTUSDISAINILAHENDUSED . . . . .	5
II. TÖÖSTUSDISAINILAHENDUSE REGISTREERINGU KEHTIVUSE PIKENDAMINE . . . . .	51
III. TÖÖSTUSDISAINILAHENDUSE REGISTREERINGU ANDMETE MUUTMINE . . . . .	51
IV. TÖÖSTUSDISAINILAHENDUSE OMANIKU ÕIGUSTE KASUTUSVALDUSSE ANDMINE . . . . .	-
V. TÖÖSTUSDISAINILAHENDUSE REGISTREERINGU KUSTUTAMINE . . . . .	51
VI. TÖÖSTUSDISAINILAHENDUSE TUNNISTUSE DUPLIKAADI VÄLJASTAMINE . . . . .	51
VII. LOENDID . . . . .	52
Registreeritud tööstusdisainilahenduste süstemaatiline loend . . . . .	52
Registreeritud tööstusdisainilahenduste registreerimistaotluste numbriline loend . . . . .	52
VIII. TÖÖSTUSDISAINIALASED ÕIGUSAKTID JA MUU INFO . . . . .	53
Riiklikus patendivolnike registris registreeritud patendivolnike nimekiri . . . . .	53
Riikide, teiste ühenduste ja valitsustevaheliste organisatsioonide koodid . . . . .	60

## CONTENTS

Internationally Agreed Numbers for the Identification of Data (INID Codes) . . . . .	4
I. REGISTERED INDUSTRIAL DESIGNS . . . . .	5
II. RENEWAL OF TERM OF INDUSTRIAL DESIGN . . . . .	51
III. CHANGE IN DATA RELATING TO THE REGISTRATION OF INDUSTRIAL DESIGN . . . . .	51
IV. TRANSFER OF RIGHTS OF PROPRIETOR OF INDUSTRIAL DESIGN INTO USUFRUCT. . . . .	-
V. DELETION OF INDUSTRIAL DESIGN REGISTRATION . . . . .	51
VI. ISSUE OF A DUPLICATE OF INDUSTRIAL DESIGN CERTIFICATE . . . . .	51
VII. LISTS . . . . .	52
Systematic List of Registered Industrial Designs . . . . .	52
Numerical List of Registration Applications of Registered Industrial Designs . . . . .	52
VIII. LEGAL ACTS AND INFORMATION. . . . .	53
List of Patent Attorneys, Registered in the Estonian State Register of Patent Attorneys . . . . .	56
List of Codes of States, Other Entities and Intergovernmental Organizations . . . . .	60

**ANDMETE IDENTIFITSEERIMISE  
RAHVUSVAHELISED NUMBERKOODID  
(INID-KOODID)**

**INTERNATIONALLY AGREED NUMBERS FOR  
THE IDENTIFICATION OF DATA  
(INID CODES)**

(11) Registreeringu number	(11) Number of the Registration
(15) Registreerimise kuupäev	(15) Date of the Registration
(18) Registreeringu kehtivuse lõppemise kuupäev	(18) Expected expiration date of the registration
(21) Registreerimistaotluse number	(21) Application Number
(22) Registreerimistaotluse esitamise kuupäev	(22) Application Filing Date
(24) Registreeringu kehtivuse alguse kuupäev	(24) Date from which the Industrial Design Right Has Effected
(28) Variantide arv	(28) Number of Industrial Designs Included in the Application
(30) Prioriteet	(30) Priority
(51) Rahvusvahelise klassifikatsiooni klassi ja alaklassi number	(51) International Classification for Industrial Designs (class and subclass of the Locarno Classification)
(54) Tööstusdisainilahenduse nimetus	(54) Title of the Industrial Design
(55) Tööstusdisainilahenduse reproduktsioon	(55) Reproduction of the Industrial Design
(72) Tööstusdisainilahenduse autor(id)	(72) Author(s) of Industrial Design
(73) Tööstusdisainilahenduse omanik(ud)	(73) Proprietor(s) of Industrial Design
(74) Patendivolinik või ühine esindaja	(74) Patent Attorney or Common Representative

# **I. REGISTREERITUD TÖÖSTUSDISAINILAHENDUSED**

(Avaldatakse tööstusdisaini kaitse seaduse § 58 lõike 8 alusel)  
Patendiamet ei ole kontrollinud tööstusdisainilahenduse uudsust ja eristatavust tulenevalt  
tööstusdisaini kaitse seaduse § 31 lõike 2 punktist 1

- (11) Registreeringu number: **00830**
- (15) Registreerimise kuupäev: 01.09.2003 (51) Klass: **14-03**
- (21) Taotluse number: D2003 00054
- (22) Esitamise kuupäev: 30.04.2003
- (24) Registreeringu kehtivuse alguse kuupäev: 30.04.2003
- (28) Variantide arv: 1
- (30) Prioriteediandmed: 29/170,245, 01.11.2002, US
- (72) Autor: Dimitre Mehandjiysky, 5737 Manton Avenue, Woodland Hills, CA 91367, US
- (73) Omanik: Nokia Corporation, Keilalahdentie 4, FIN-02150 Espoo, FI
- (74) Patendivolinik või ühine esindaja: Kaie Puur

(54) Nimetus: **Käsitelefon**

(55) Reproduktioon:

00830-01

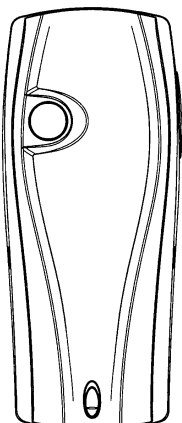
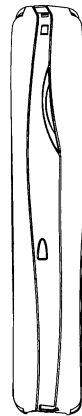
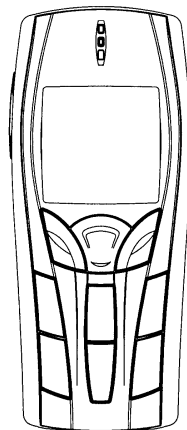
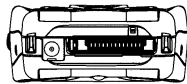

- (11) Registreeringu number: **00831**
- (15) Registreerimise kuupäev: 01.09.2003 (51) Klass: **14-03**
- (21) Taotluse number: D2003 00055
- (22) Esitamise kuupäev: 30.04.2003
- (24) Registreeringu kehtivuse alguse kuupäev: 30.04.2003
- (28) Variantide arv: 1
- (30) Prioriteediandmed: 29/170,246, 01.11.2002, US
- (72) Autor: Dimitre Mehandjiysky, 5737 Manton Avenue, Woodland Hills, CA 91367, US
- (73) Omanik: Nokia Corporation, Keilalahdentie 4, FIN-02150 Espoo, FI
- (74) Patendivolinik või ühine esindaja: Kaie Puur

(54) Nimetus: **Käsitelefoni esipaneel**

(55) Reproduktsoon:

00831-01

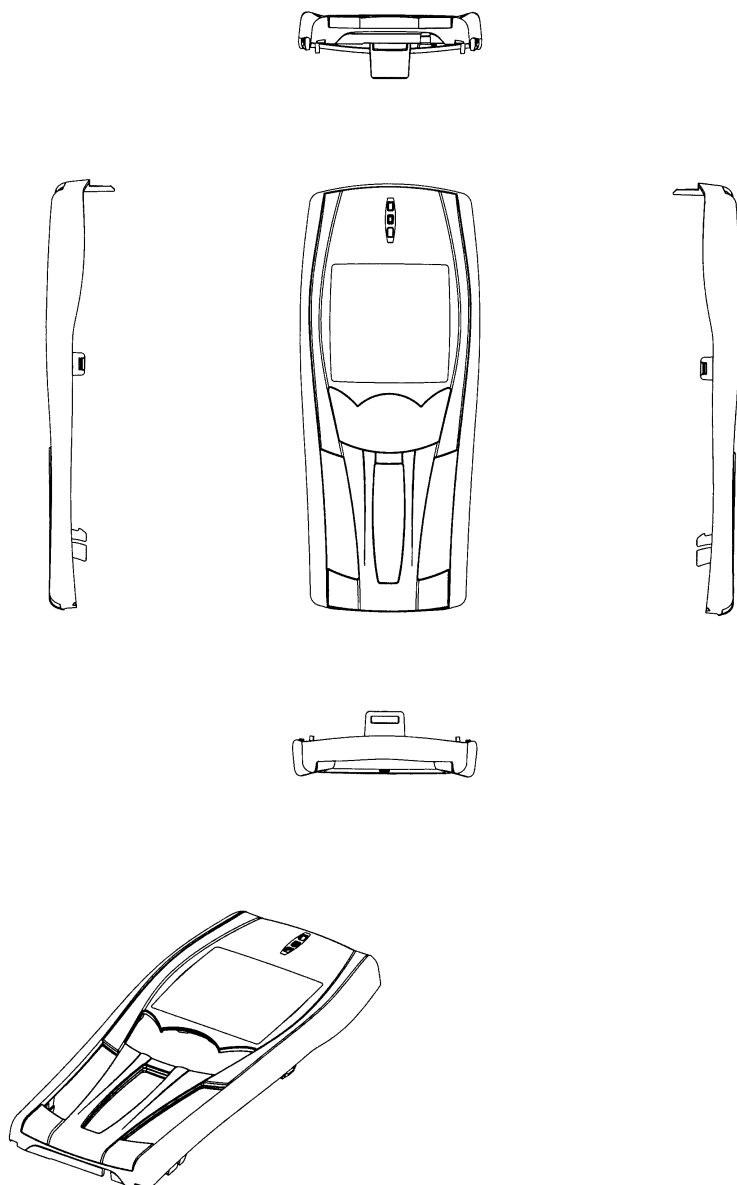



- (11) Registreeringu number: **00832**
- (15) Registreerimise kuupäev: 01.09.2003 (51) Klass: **14-03**
- (21) Taotluse number: D2003 00056
- (22) Esitamise kuupäev: 30.04.2003
- (24) Registreeringu kehtivuse alguse kuupäev: 30.04.2003
- (28) Variantide arv: 1
- (30) Prioriteediandmed: 29/170,210, 01.11.2002, US
- (72) Autor: Dimitre Mehandjiysky, 5737 Manton Avenue, Woodland Hills, CA 91367, US
- (73) Omanik: Nokia Corporation, Keilalahdentie 4, FIN-02150 Espoo, FI
- (74) Patendivolinik või ühine esindaja: Kaie Puur

(54) Nimetus: **Käsitelefoni tagapaneel**

(55) Reproduktsoon:

00832-01

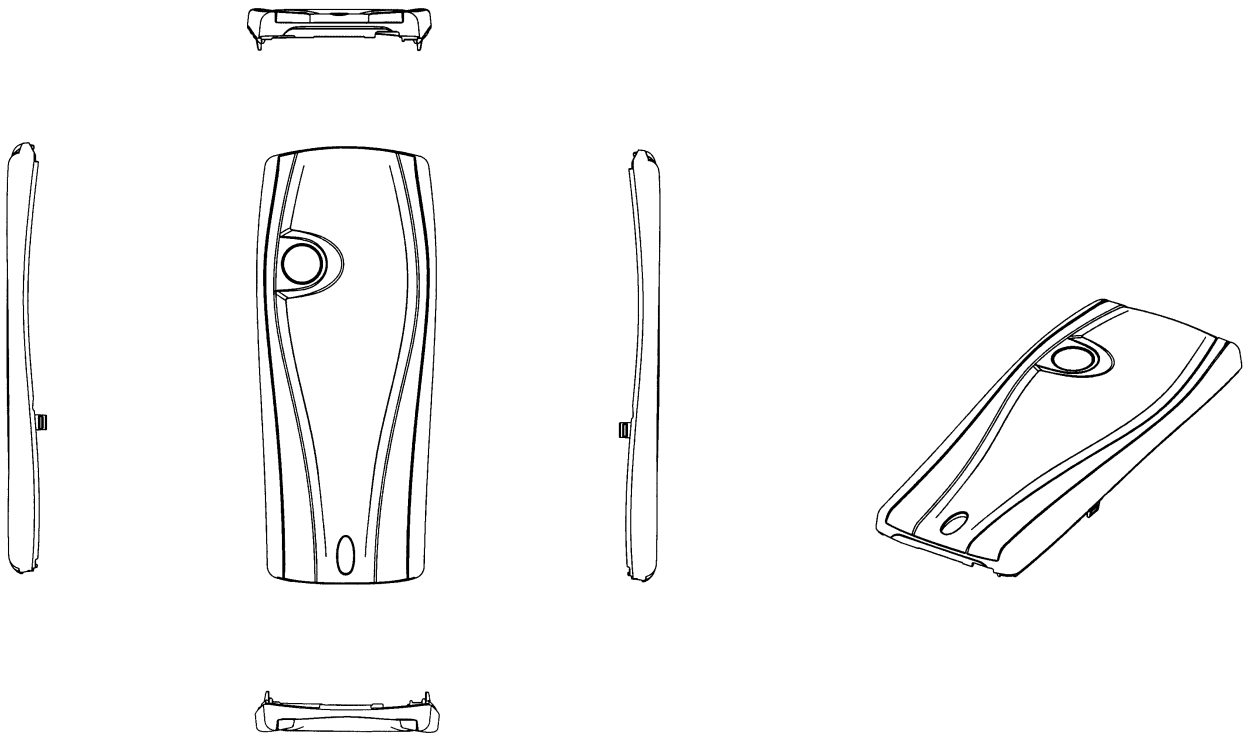

- (11) Registreeringu number: **00833**
- (15) Registreerimise kuupäev: 01.09.2003 (51) Klass: **14-03**
- (21) Taotluse number: D2003 00057
- (22) Esitamise kuupäev: 30.04.2003
- (24) Registreeringu kehtivuse alguse kuupäev: 30.04.2003
- (28) Variantide arv: 1
- (30) Prioriteediandmed: 29/170,229, 01.11.2002, US
- (72) Autor: Dimitre Mehandjiysky, 5737 Manton Avenue, Woodland Hills, CA 91367, US
- (73) Omanik: Nokia Corporation, Keilalahdentie 4, FIN-02150 Espoo, FI
- (74) Patendivolinik või ühine esindaja: Kaie Puur

(54) Nimetus: **Käsitelefoni klaviatuur**

(55) Reproduksioon:

00833-01

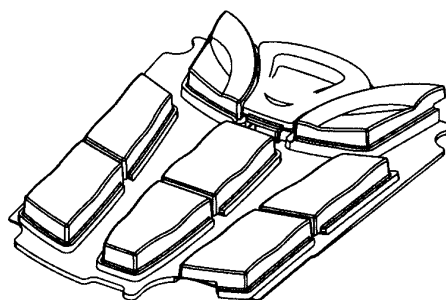
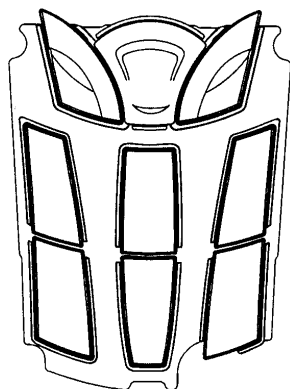

(11) Registreeringu number: **00834**

(15) Registreerimise kuupäev: 01.09.2003

(51) Klass: **14-03**

(21) Taotluse number: D2003 00058

(22) Esitamise kuupäev: 30.04.2003

(24) Registreeringu kehtivuse  
alguse kuupäev: 30.04.2003

(28) Variantide arv: 1

(30) Prioriteediandmed: 29/170,182, 01.11.2002, US

(72) Autor: Wei-Jong William Sheu, 5727 Canoga Avenue, Apt. 368,  
Woodland Hills, CA 91367, US

(73) Omanik: Nokia Corporation, Keilalahdentie 4, FIN-02150 Espoo, FI

(74) Patendivolinik või ühine esindaja: Kaie Puur

(54) Nimetus: **Käsitelefon**

(55) Reproduktioon:

00834-01

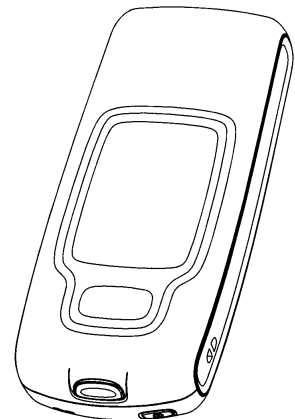
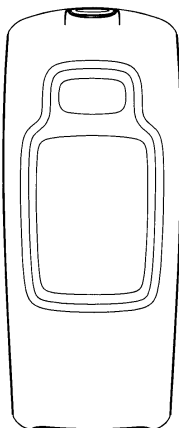
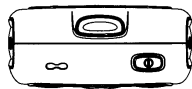
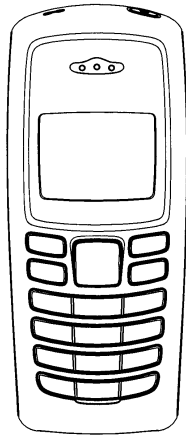
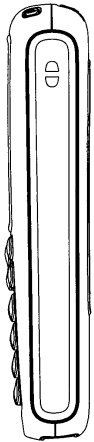
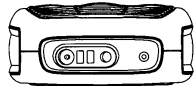

- (11) Registreeringu number: **00835**
- (15) Registreerimise kuupäev: 01.09.2003 (51) Klass: **14-03**
- (21) Taotluse number: D2003 00059
- (22) Esitamise kuupäev: 30.04.2003
- (24) Registreeringu kehtivuse alguse kuupäev: 30.04.2003
- (28) Variantide arv: 1
- (30) Prioriteediandmed: 29/170,230, 01.11.2002, US
- (72) Autor: Wei-Jong William Sheu, 5727 Canoga Avenue, Apt. 368, Woodland Hills, CA 91367, US
- (73) Omanik: Nokia Corporation, Keilalahdentie 4, FIN-02150 Espoo, FI
- (74) Patendivolinik või ühine esindaja: Kaie Puur

(54) Nimetus: **Käsitelefoni esipaneel**

(55) Reproduktsoon:

00835-01

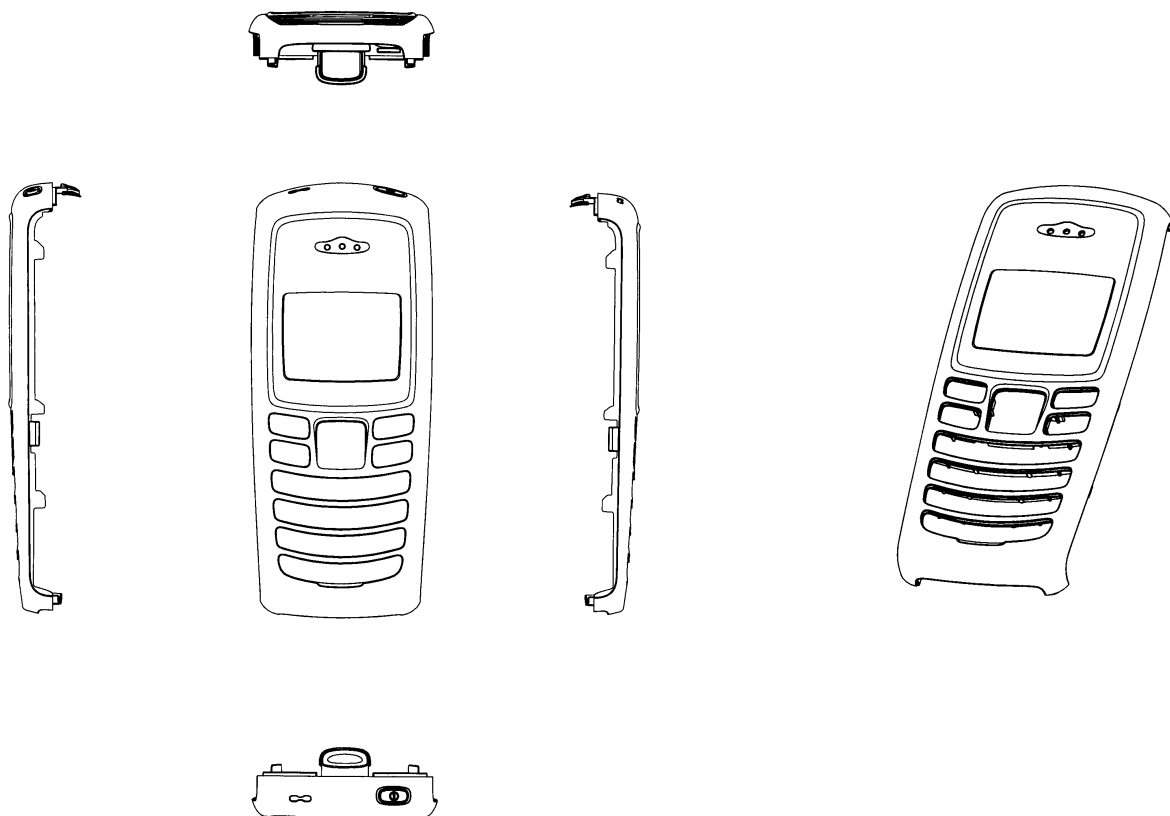

- (11) Registreeringu number: **00836**
- (15) Registreerimise kuupäev: 01.09.2003 (51) Klass: **14-03**
- (21) Taotluse number: D2003 00060
- (22) Esitamise kuupäev: 30.04.2003
- (24) Registreeringu kehtivuse alguse kuupäev: 30.04.2003
- (28) Variantide arv: 1
- (30) Prioriteediandmed: 29/170,208, 01.11.2002, US
- (72) Autor: Wei-Jong William Sheu, 5727 Canoga Avenue, Apt. 368, Woodland Hills, CA 91367, US
- (73) Omanik: Nokia Corporation, Keilalahdentie 4, FIN-02150 Espoo, FI
- (74) Patendivolinik või ühine esindaja: Kaie Puur

(54) Nimetus: **Käsitelefoni tagapaneel**

(55) Reproduktioon:

00836-01

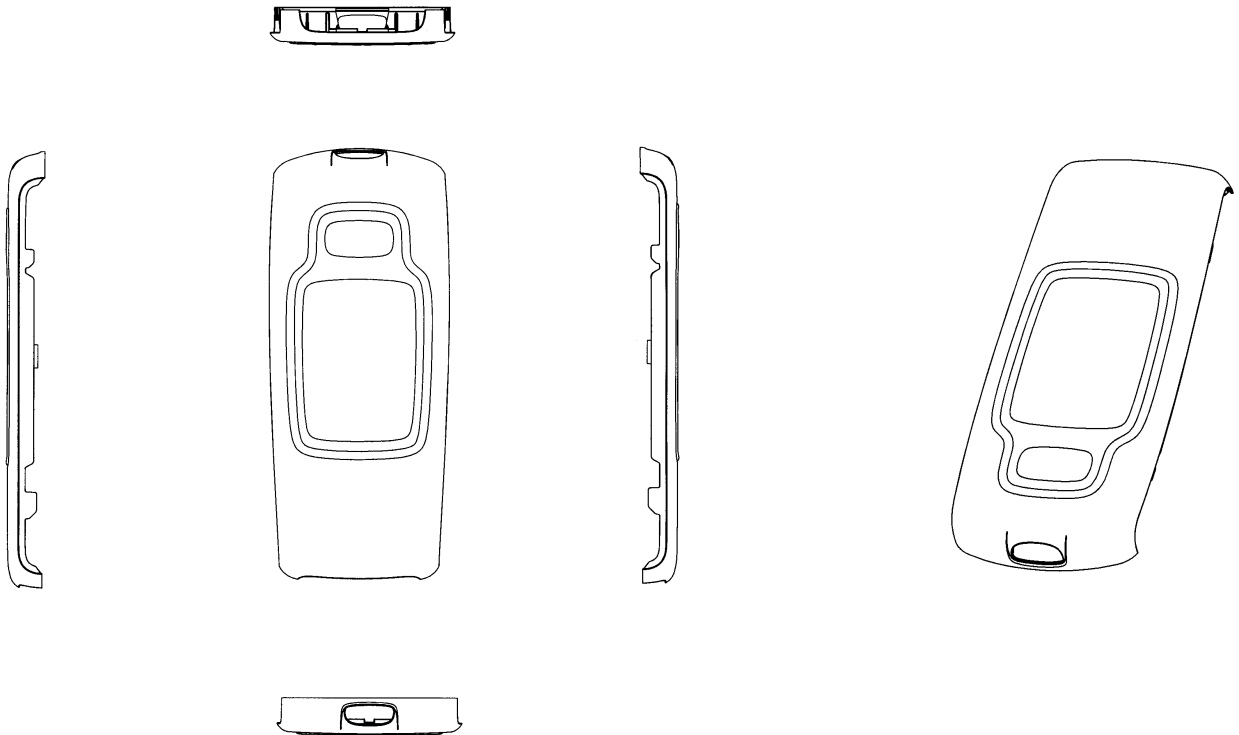

- (11) Registreeringu number: **00837**
- (15) Registreerimise kuupäev: 01.09.2003 (51) Klass: **14-03**
- (21) Taotluse number: D2003 00061
- (22) Esitamise kuupäev: 30.04.2003
- (24) Registreeringu kehtivuse alguse kuupäev: 30.04.2003
- (28) Variantide arv: 1
- (30) Prioriteediandmed: 29/170,211, 01.11.2002, US
- (72) Autor: Wei-Jong William Sheu, 5727 Canoga Avenue, Apt. 368, Woodland Hills, CA 91367, US
- (73) Omanik: Nokia Corporation, Keilalahdentie 4, FIN-02150 Espoo, FI
- (74) Patendivolinik või ühine esindaja: Kaie Puur

(54) Nimetus: **Käsitelefoni klaviatuur**

(55) Reproduktsoon:

00837-01

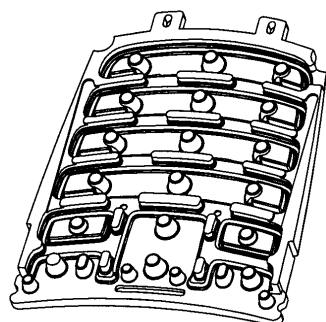
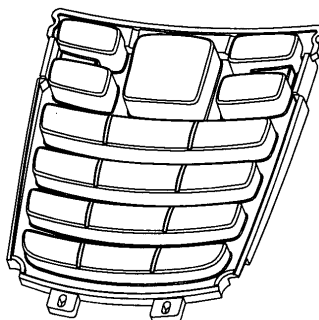
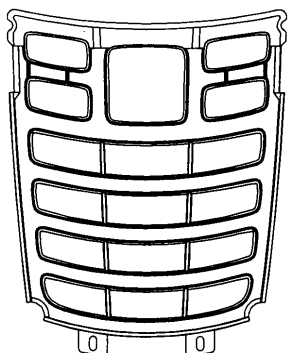

(11) Registreeringu number:

**00838**

(15) Registreerimise kuupäev:

01.09.2003

(51) Klass: **14-03**

(21) Taotluse number:

D2003 00062

(22) Esitamise kuupäev:

30.04.2003

(24) Registreeringu kehtivuse  
alguse kuupäev:

30.04.2003

(28) Variantide arv:

1

(30) Prioriteediandmed:

29/170,227, 01.11.2002, US

(72) Autor:

Wei-Jong William Sheu, 5727 Canoga Avenue, Apt. 368,  
Woodland Hills, CA 91367, US

(73) Omanik:

Nokia Corporation, Keilalahdentie 4, FIN-02150 Espoo, FI

(74) Patendivolinik või ühine esindaja:

Kaie Puur

(54) Nimetus:

**Käsitelefon**

(55) Reproduktioon:

00838-01

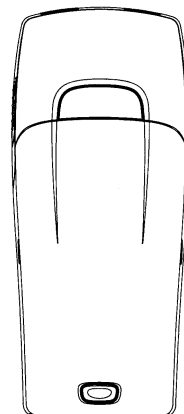
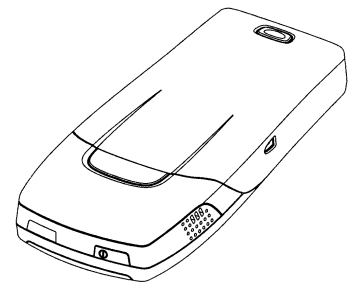
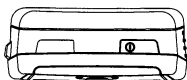
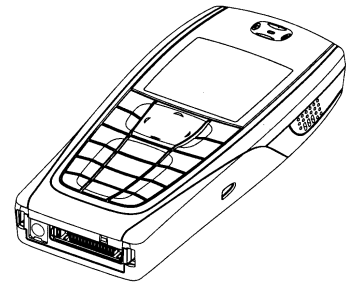
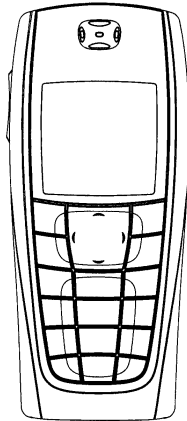
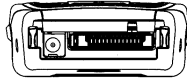

(11) Registreeringu number: **00839**

(15) Registreerimise kuupäev: 01.09.2003

(51) Klass: **14-03**

(21) Taotluse number: D2003 00063

(22) Esitamise kuupäev: 30.04.2003

(24) Registreeringu kehtivuse  
alguse kuupäev: 30.04.2003

(28) Variantide arv: 1

(30) Prioriteediandmed: 29/170,209, 01.11.2002, US

(72) Autor: Wei-Jong William Sheu, 5727 Canoga Avenue, Apt. 368,  
Woodland Hills, CA 91367, US

(73) Omanik: Nokia Corporation, Keilalahdentie 4, FIN-02150 Espoo, FI

(74) Patendivolinik või ühine esindaja: Kaie Puur

(54) Nimetus: **Käsitelefoni esipaneel**

(55) Reproduktsoon:

00839-01

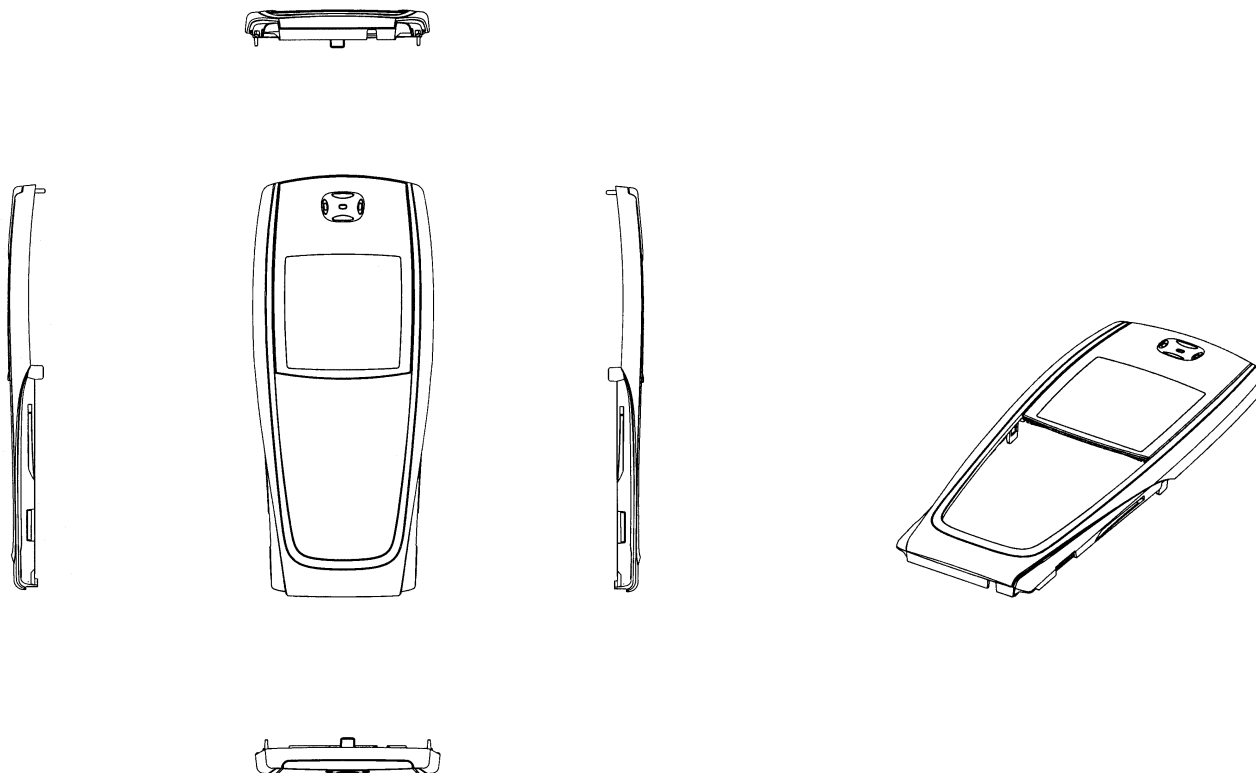



(11) Registreeringu number: **00840**

(15) Registreerimise kuupäev: 01.09.2003

(51) Klass: **14-03**

(21) Taotluse number: D2003 00064

(22) Esitamise kuupäev: 30.04.2003

(24) Registreeringu kehtivuse  
alguse kuupäev: 30.04.2003

(28) Variantide arv: 1

(30) Prioriteediandmed: 29/170,248, 01.11.2002, US

(72) Autor: Wei-Jong William Sheu, 5727 Canoga Avenue, Apt. 368,  
Woodland Hills, CA 91367, US

(73) Omanik: Nokia Corporation, Keilalahdentie 4, FIN-02150 Espoo, FI

(74) Patendivolinik või ühine esindaja: Kaie Puur

(54) Nimetus: **Käsitelefoni tagapaneel**

(55) Reproduktioon:

00840-01

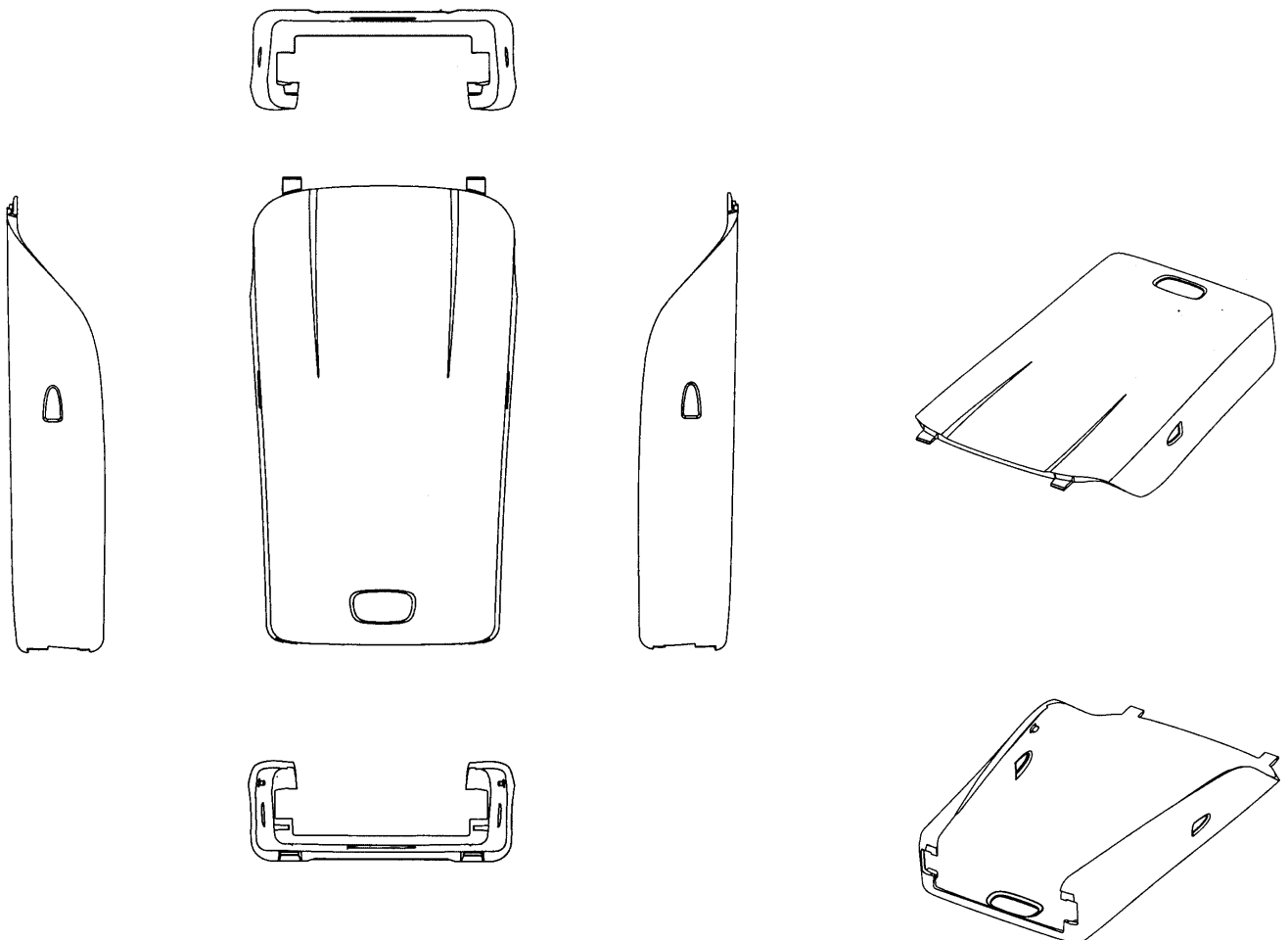

- (11) Registreeringu number: **00841**
- (15) Registreerimise kuupäev: 01.09.2003 (51) Klass: **14-03**
- (21) Taotluse number: D2003 00065
- (22) Esitamise kuupäev: 30.04.2003
- (24) Registreeringu kehtivuse alguse kuupäev: 30.04.2003
- (28) Variantide arv: 1
- (30) Prioriteediandmed: 29/170,247, 01.11.2002, US
- (72) Autor: Wei-Jong William Sheu, 5727 Canoga Avenue, Apt. 368, Woodland Hills, CA 91367, US
- (73) Omanik: Nokia Corporation, Keilalahdentie 4, FIN-02150 Espoo, FI
- (74) Patendivolinik või ühine esindaja: Kaie Puur

(54) Nimetus: **Käsitelefoni klaviatuur**

(55) Reproduktsoon:

00841-01

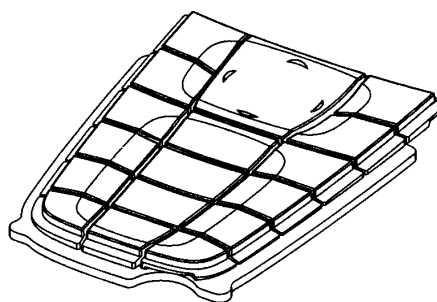
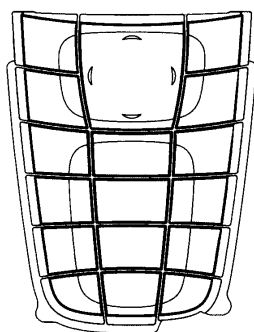

- (11) Registreeringu number: **00842**
- (15) Registreerimise kuupäev: 01.09.2003 (51) Klass: **14-03, 14-01**
- (21) Taotluse number: D2003 00067
- (22) Esitamise kuupäev: 30.04.2003
- (24) Registreeringu kehtivuse alguse kuupäev: 30.04.2003
- (28) Variantide arv: 1
- (30) Prioriteediandmed: M20020649, 31.10.2002, FI
- (72) Autor: Valtteri Eroma, Itätuulenkuja 5 B 31, 02100 Espoo, FI
- (73) Omanik: Nokia Corporation, Keilalahdentie 4, FIN-02150 Espoo, FI
- (74) Patendivolinik või ühine esindaja: Kaie Puur

(54) Nimetus: **Kaamera koos peakomplektiga**

(55) Reproduksioon:

00842-01

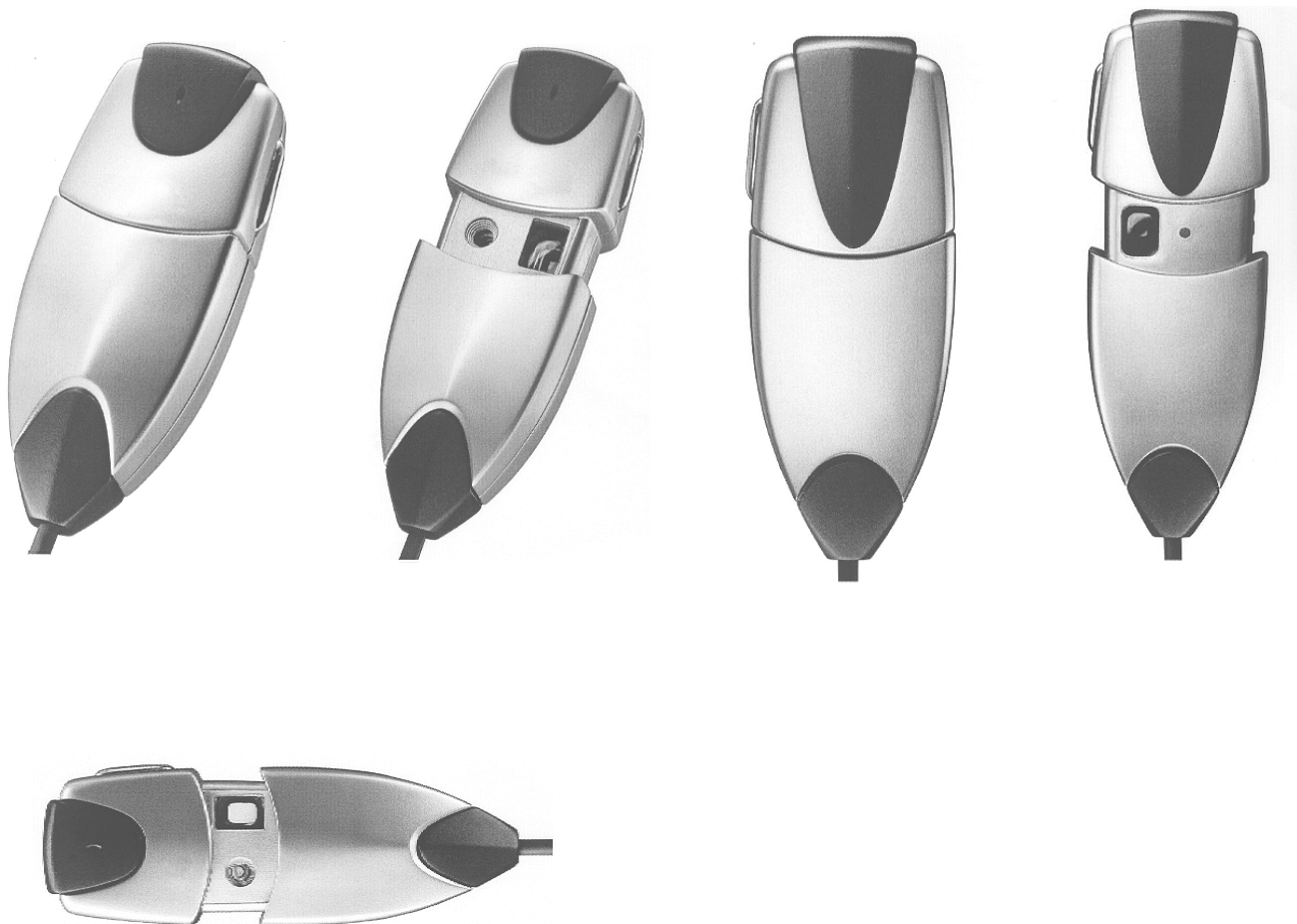

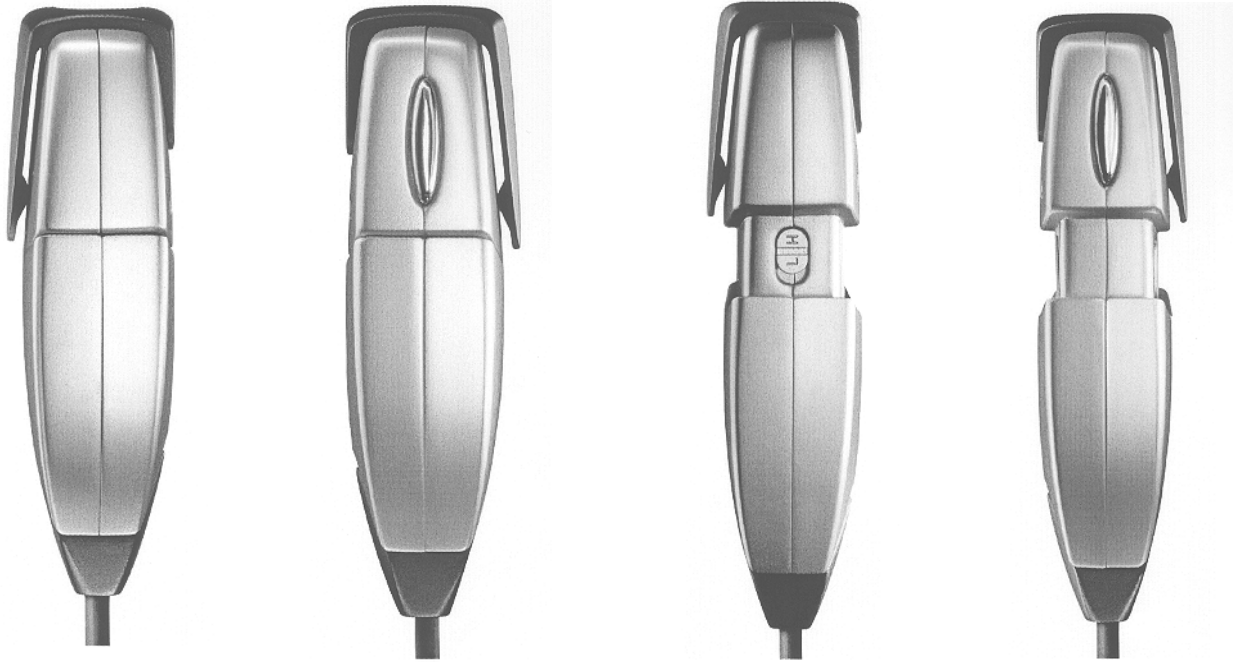



- (11) Registreeringu number: **00843**
- (15) Registreerimise kuupäev: 24.09.2003 (51) Klass: **23-02**
- (21) Taotluse number: D2003 00080
- (22) Esitamise kuupäev: 26.05.2003
- (24) Registreeringu kehtivuse alguse kuupäev: 26.05.2003
- (28) Variantide arv: 2
- (30) Prioriteediandmed: 402 09 785. 8, 25.11.2002, DE
- (72) Autor: Sven Feustel, Breitscheidstr. 91, D-70176 Stuttgart, DE - variandid 1, 2  
Andreas Haug, Franklinstr. 77, D-70435 Stuttgart, DE - variandid 1, 2  
Tom Schönherr, Argonnenstr. 22, D-70374 Stuttgart, DE - variandid 1, 2  
Felix Ballerstedt, Melanchtonstr. 15, D-10557 Berlin, DE - variant 1  
Hansgrohe AG, Auestrasse 5-9, D-77761 Schiltach, DE
- (73) Omanik: Hansgrohe AG, Auestrasse 5-9, D-77761 Schiltach, DE
- (74) Patendivolinik või ühine esindaja: Raivo Koitel
- (54) Nimetus: **Sanitaarseadis**
- (55) Reproduksioon:

00843-01

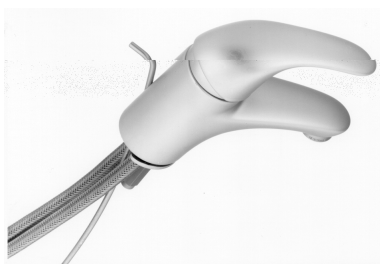

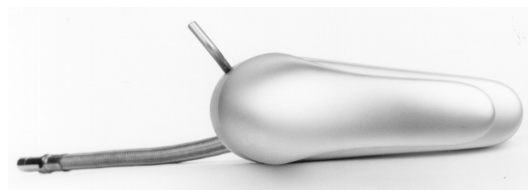

---

00843-02

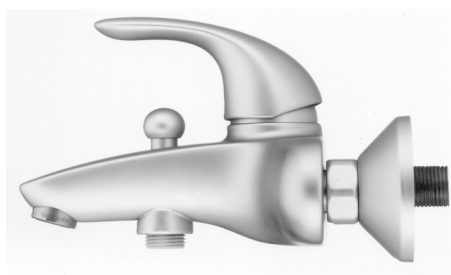





- (11) Registreeringu number: **00844**
- (15) Registreerimise kuupäev: 24.09.2003 (51) Klass: **09-01**
- (21) Taotluse number: D2003 00091
- (22) Esitamise kuupäev: 15.07.2003
- (24) Registreeringu kehtivuse alguse kuupäev: 15.07.2003
- (28) Variantide arv: 1
- (72) Autor: Arne Luhalaid, Laki 5, 10621 Tallinn, EE  
Peeter Rimmel, Laki 5, 10621 Tallinn, EE  
Pearu Lehis, Laki 5, 10621 Tallinn, EE  
AS Tehnoplast, Laki 5, 10621 Tallinn, EE
- (73) Omanik: AS Tehnoplast, Laki 5, 10621 Tallinn, EE
- (74) Patendivolinik või ühine esindaja: Ott Moorlat

(54) Nimetus: **Pudel**

(55) Reproduktsoon:

00844-01

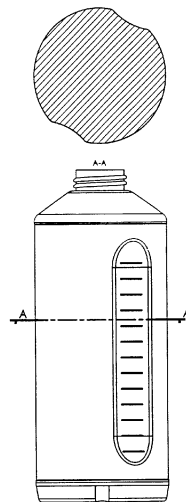
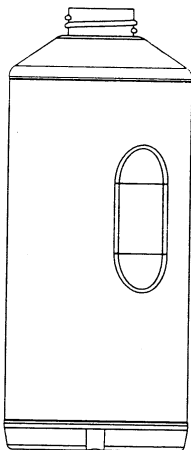
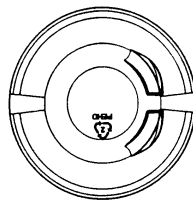
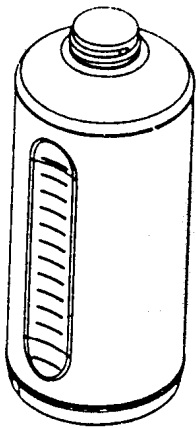

(11) Registreeringu number: **00845**

(15) Registreerimise kuupäev: 24.09.2003

(21) Taotluse number: D2003 00103

(22) Esitamise kuupäev: 30.07.2003

(24) Registreeringu kehtivuse  
alguse kuupäev: 30.07.2003

(28) Variantide arv: 2

(72) Autor: Mehis Viita, Tiigi 8-3, 51003 Tartu, EE

(73) Omanik: OÜ Tarmetec, Puiestee 2, 50303 Tartu, EE

(74) Patendivolinik või ühine esindaja: Kaie Puur

(51) Klass: **12-16**

(54) Nimetus: **TT-laternakandur sõidukitele**

(55) Reproduksioon:

00845-01

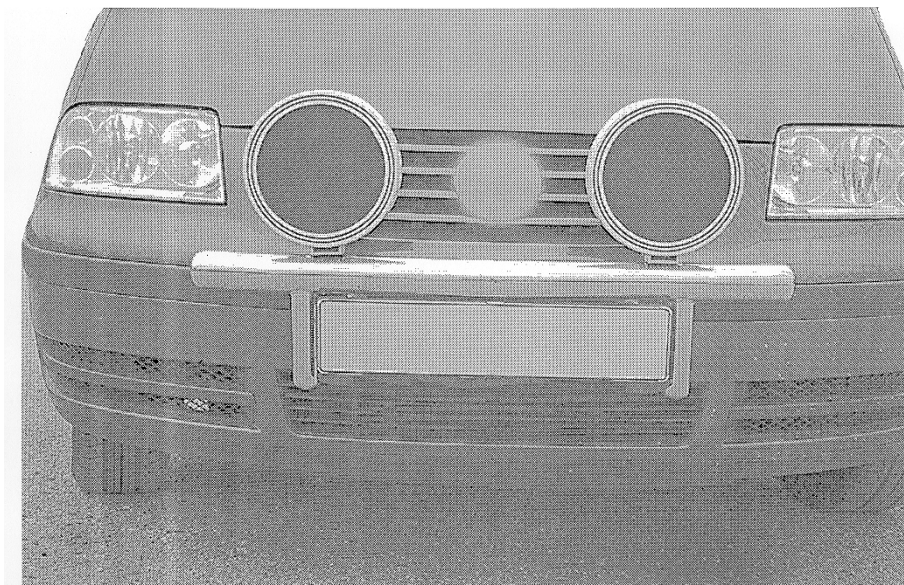
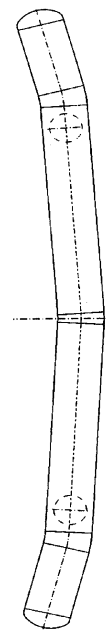
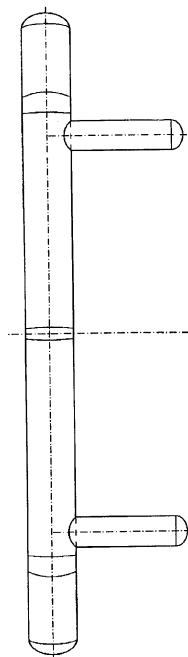
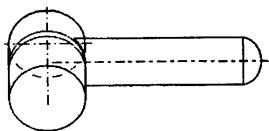

00845-02

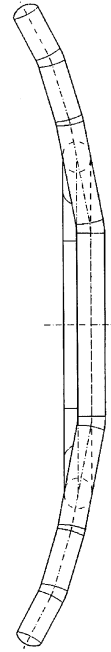
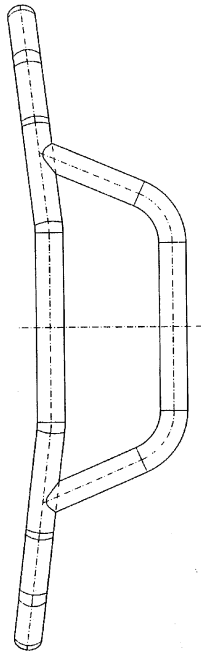
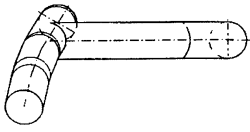

(11) Registreeringu number: **00846**

(15) Registreerimise kuupäev: 24.09.2003

(51) Klass: **04-02**

(21) Taotluse number: D2003 00104

(22) Esitamise kuupäev: 30.07.2003

(24) Registreeringu kehtivuse  
alguse kuupäev: 30.07.2003

(28) Variantide arv: 1

(30) Prioriteediandmed: 29/175,647, 10.02.2003, US

(72) Autor: *Autori andmeid ei avalikustata*

(73) Omanik: Philip Morris Products S.A., Quai Jeanrenaud 3, CH-2000 Neuchâtel, CH

(74) Patendivolinik või ühine esindaja: Toom Pungas

(54) Nimetus: **Haripuhastusseade**

(55) Reproduksioon:

00846-01

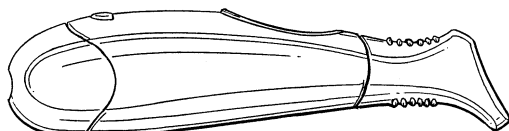
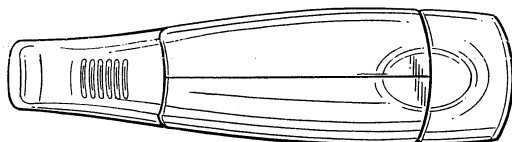
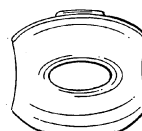
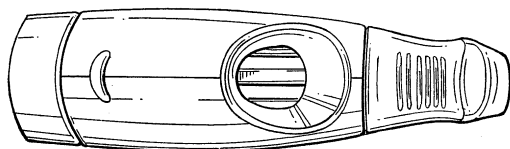
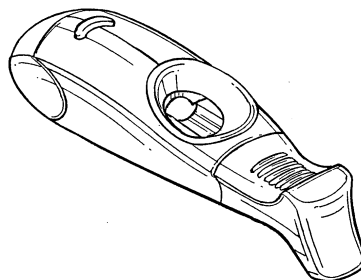
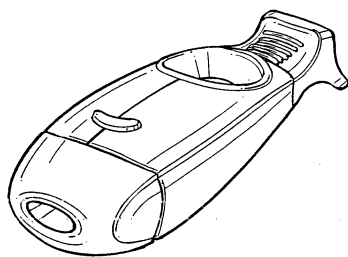

- (11) Registreeringu number: **00847**
- (15) Registreerimise kuupäev: 02.10.2003 (51) Klass: **14-03**
- (21) Taotluse number: D2003 00066
- (22) Esitamise kuupäev: 30.04.2003
- (24) Registreeringu kehtivuse alguse kuupäev: 30.04.2003
- (28) Variantide arv: 1
- (30) Prioriteediandmed: M20020649, 31.10.2002, FI
- (72) Autor: Lea Sarasjoki, Kellonsoittajankatu 10 as 1, 24100 Salo, FI
- (73) Omanik: Nokia Corporation, Keilalahdentie 4, FIN-02150 Espoo, FI
- (74) Patendivolinik või ühine esindaja: Kaie Puur

(54) Nimetus: **Käsitelefoni alus**

(55) Reproduksioon:

00847-01

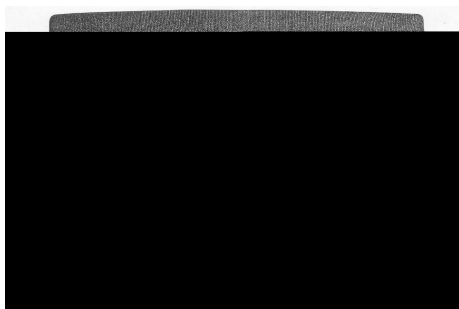

- (11) Registreeringu number: **00848**
- (15) Registreerimise kuupäev: 02.10.2003 (51) Klass: **14-03**
- (21) Taotluse number: D2003 00095
- (22) Esitamise kuupäev: 17.07.2003
- (24) Registreeringu kehtivuse alguse kuupäev: 17.07.2003
- (28) Variantide arv: 1
- (30) Prioriteediandmed: M20030048, 07.02.2003, FI
- (72) Autor: Iain Pottie, Springbank, High Street, Little Sandhurst, Sandhurst, Berkshire, GU47 8LR, GB  
Anthony Dalby, 30 Chandos Avenue, Ealing, London W5 4 ER, GB  
Nokia Corporation, Keilalahdentie 4, FIN-02150 Espoo, FI
- (73) Omanik: Kaie Puur
- (74) Patendivolinik või ühine esindaja: Kaie Puur

(54) Nimetus: **Käsitelefon**

(55) Reproduktsoon:

00848-01

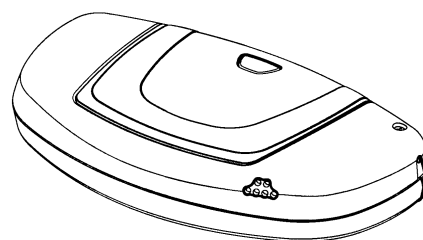
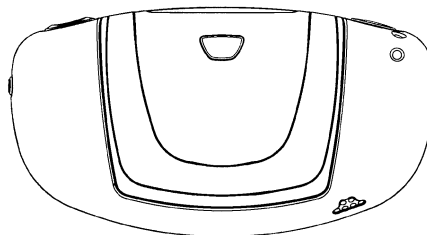
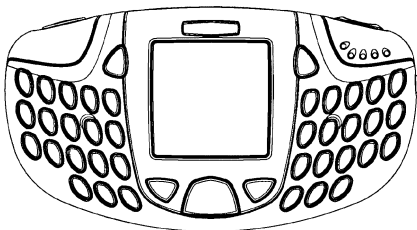
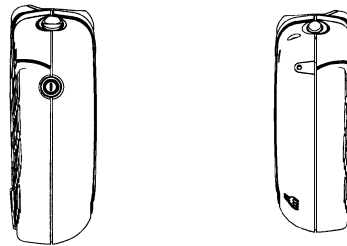

- (11) Registreeringu number: **00849**
- (15) Registreerimise kuupäev: 02.10.2003 (51) Klass: **14-03**
- (21) Taotluse number: D2003 00096
- (22) Esitamise kuupäev: 17.07.2003
- (24) Registreeringu kehtivuse alguse kuupäev: 17.07.2003
- (28) Variantide arv: 1
- (30) Prioriteediandmed: M20030048, 07.02.2003, FI
- (72) Autor: Iain Pottie, Springbank, High Street, Little Sandhurst, Sandhurst, Berkshire, GU47 8LR, GB  
Anthony Dalby, 30 Chandos Avenue, Ealing, London W5 4 ER, GB  
Nokia Corporation, Keilalahdentie 4, FIN-02150 Espoo, FI
- (73) Omanik:
- (74) Patendivolinik või ühine esindaja: Kaie Puur

(54) Nimetus: **Käsitelefoni esipaneel**

(55) Reproduktioon:

00849-01

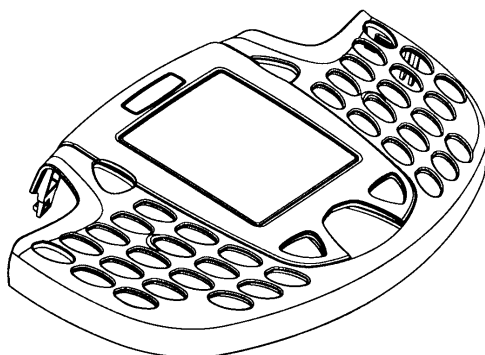
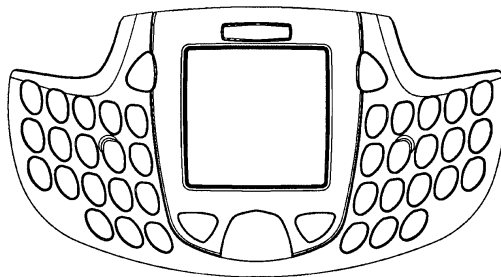
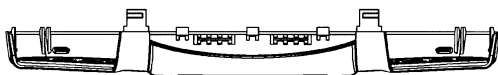

- (11) Registreeringu number: **00850**
- (15) Registreerimise kuupäev: 02.10.2003 (51) Klass: **14-03**
- (21) Taotluse number: D2003 00097
- (22) Esitamise kuupäev: 17.07.2003
- (24) Registreeringu kehtivuse  
alguse kuupäev: 17.07.2003
- (28) Variantide arv: 1
- (30) Prioriteediandmed: M20030048, 07.02.2003, FI
- (72) Autor: Iain Pottie, Springbank, High Street, Little Sandhurst, Sandhurst,  
Berkshire, GU47 8LR, GB  
Anthony Dalby, 30 Chandos Avenue, Ealing, London W5 4 ER, GB  
Nokia Corporation, Keilalahdentie 4, FIN-02150 Espoo, FI
- (73) Omanik: Nokia Corporation, Keilalahdentie 4, FIN-02150 Espoo, FI
- (74) Patendivolinik või ühine esindaja: Kaie Puur

(54) Nimetus: **Käsitelefoni klaviatuur**

(55) Reproduktsoon:

00850-01

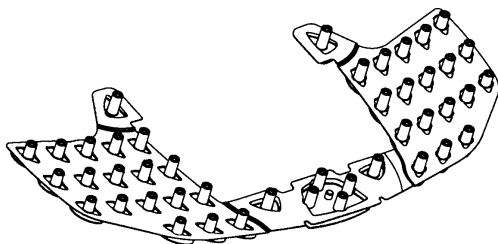
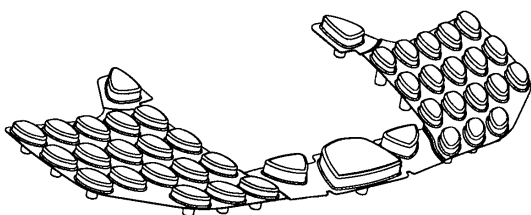
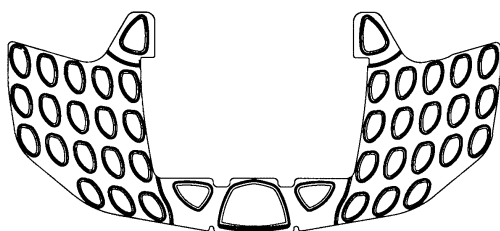



- (11) Registreeringu number: **00851**
- (15) Registreerimise kuupäev: 02.10.2003 (51) Klass: **14-03**
- (21) Taotluse number: D2003 00098
- (22) Esitamise kuupäev: 17.07.2003
- (24) Registreeringu kehtivuse alguse kuupäev: 17.07.2003
- (28) Variantide arv: 1
- (30) Prioriteediandmed: M20030049, 07.02.2003, FI
- (72) Autor: Daren Leith, Nokia UK Ltd, Summit Avenue, Farnborough, Hampshire GU 14 ONG, GB  
Iain Pottie, Springbank, High Street, Little Sandhurst, Sandhurst, Berkshire, GU47 8LR, GB  
Anthony Dalby, 30 Chandos Avenue, Ealing, London W5 4 ER, GB  
Nokia Corporation, Keilalahdentie 4, FIN-02150 Espoo, FI
- (73) Omanik: Nokia Corporation, Keilalahdentie 4, FIN-02150 Espoo, FI
- (74) Patendivolinik või ühine esindaja: Kaie Puur

(54) Nimetus: **Käsitelefon**

(55) Reproduktioon:

00851-01

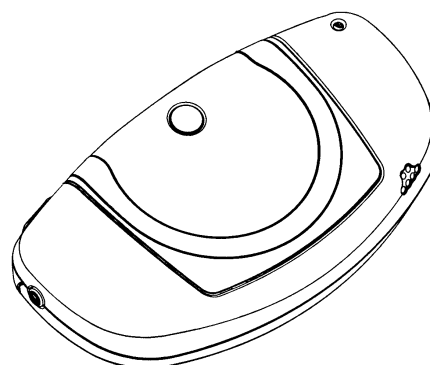
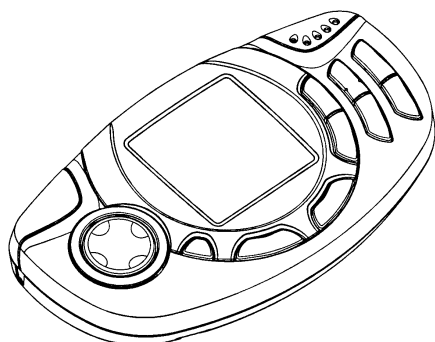
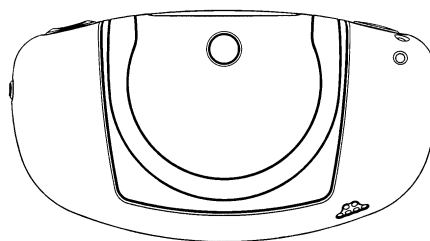
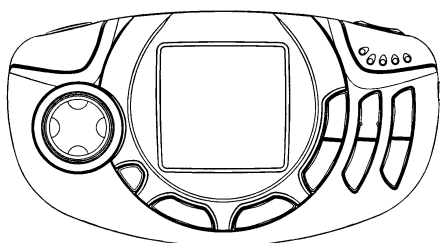

- (11) Registreeringu number: **00852**
- (15) Registreerimise kuupäev: 02.10.2003 (51) Klass: **14-03**
- (21) Taotluse number: D2003 00099
- (22) Esitamise kuupäev: 17.07.2003
- (24) Registreeringu kehtivuse alguse kuupäev: 17.07.2003
- (28) Variantide arv: 1
- (30) Prioriteediandmed: M20030049, 07.02.2003, FI
- (72) Autor: Daren Leith, Nokia UK Ltd, Summit Avenue, Farnborough, Hampshire GU 14 ONG, GB  
Iain Pottie, Springbank, High Street, Little Sandhurst, Sandhurst, Berkshire, GU47 8LR, GB  
Anthony Dalby, 30 Chandos Avenue, Ealing, London W5 4 ER, GB
- (73) Omanik: Nokia Corporation, Keilalahdentie 4, FIN-02150 Espoo, FI
- (74) Patendivolinik või ühine esindaja: Kaie Puur

(54) Nimetus: **Käsitelefoni esipaneel**

(55) Reproduktsoon:

00852-01

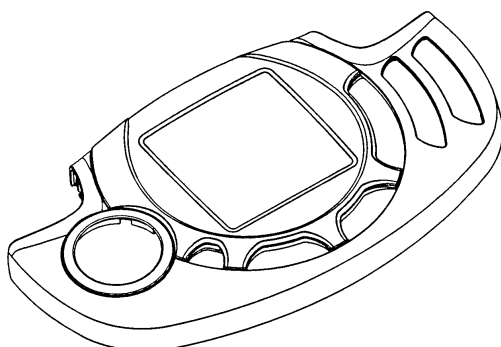
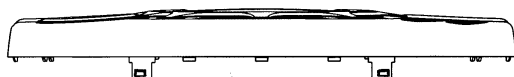
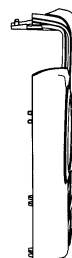
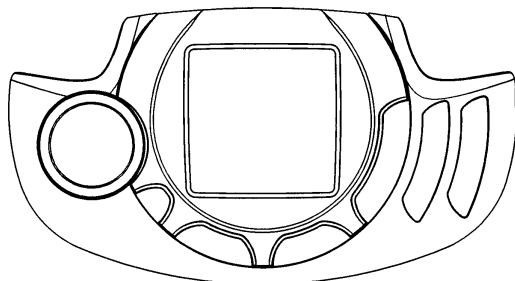
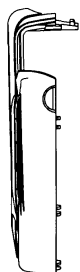
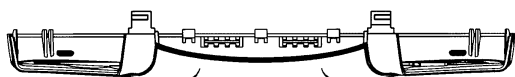

- (11) Registreeringu number: **00853**
- (15) Registreerimise kuupäev: 02.10.2003 (51) Klass: **14-03**
- (21) Taotluse number: D2003 00100
- (22) Esitamise kuupäev: 17.07.2003
- (24) Registreeringu kehtivuse alguse kuupäev: 17.07.2003
- (28) Variantide arv: 1
- (30) Prioriteediandmed: M20030049, 07.02.2003, FI
- (72) Autor: Daren Leith, Nokia UK Ltd, Summit Avenue, Farnborough, Hampshire GU 14 ONG, GB  
Iain Pottie, Springbank, High Street, Little Sandhurst, Sandhurst, Berkshire, GU47 8LR, GB  
Anthony Dalby, 30 Chandos Avenue, Ealing, London W5 4 ER, GB
- (73) Omanik: Nokia Corporation, Keilalahdentie 4, FIN-02150 Espoo, FI
- (74) Patendivolinik või ühine esindaja: Kaie Puur

(54) Nimetus: **Käsitelefoni klaviatuur**

(55) Reproduktsoon:

00853-01

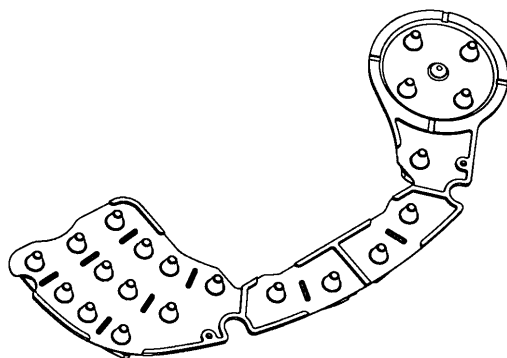
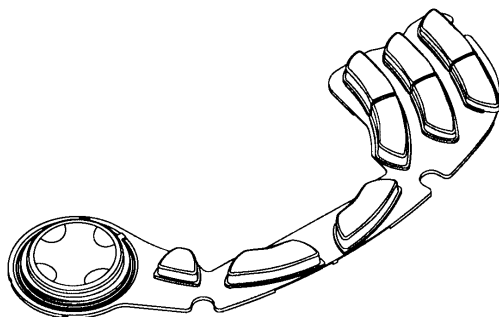
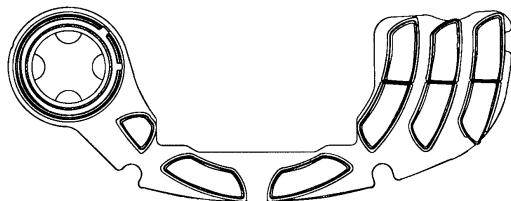

(11) Registreeringu number: **00854**

(15) Registreerimise kuupäev: 13.10.2003

(51) Klass: **09-03**

(21) Taotluse number: D200300051

(22) Esitamise kuupäev: 15.04.2003

(24) Registreeringu kehtivuse  
alguse kuupäev: 15.04.2003

(28) Variantide arv: 4

(72) Autor: Lembit Kurik, J. Koorti 8-22, 13623 Tallinn, EE  
Talis Bachmann, Veski 20-4, 51005 Tartu, EE  
Veljo Sinivee, Trummi 23A-7, 12619 Tallinn, EE

(73) Omanik: Talis Bachmann, Veski 20-4, 51005 Tartu, EE

(74) Patendivolinik või ühine esindaja: Ott Moorlat

(54) Nimetus: **Osavusmängu elemendid ja nende hoidmise karp**

(55) Reproduktioon:

00854-01

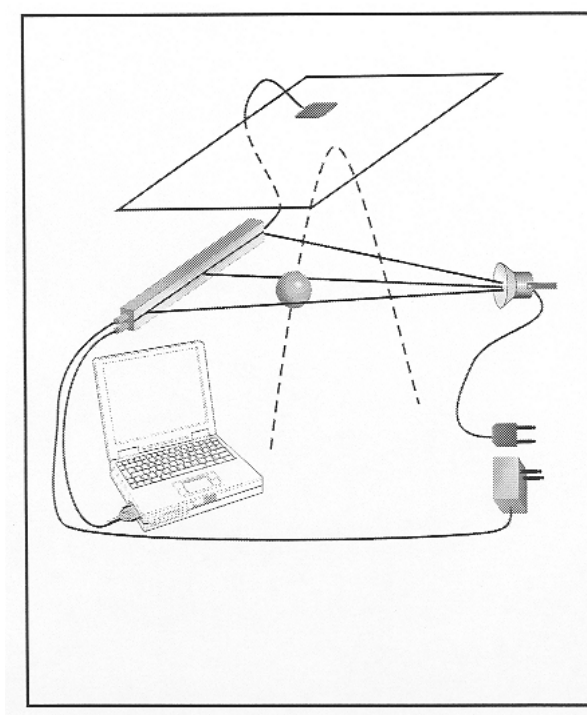
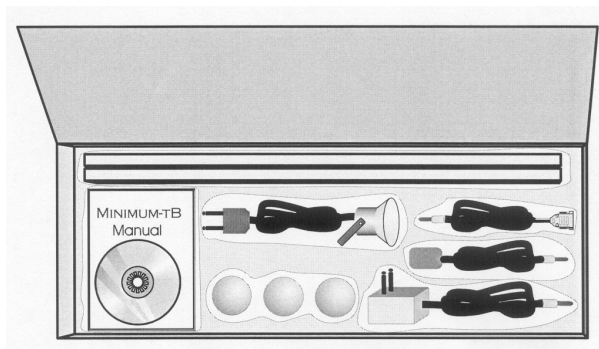

00854-02

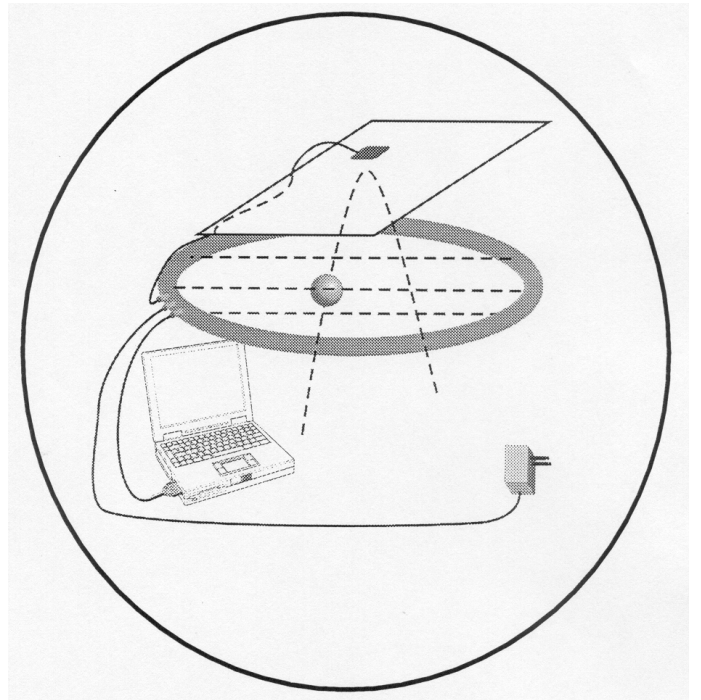
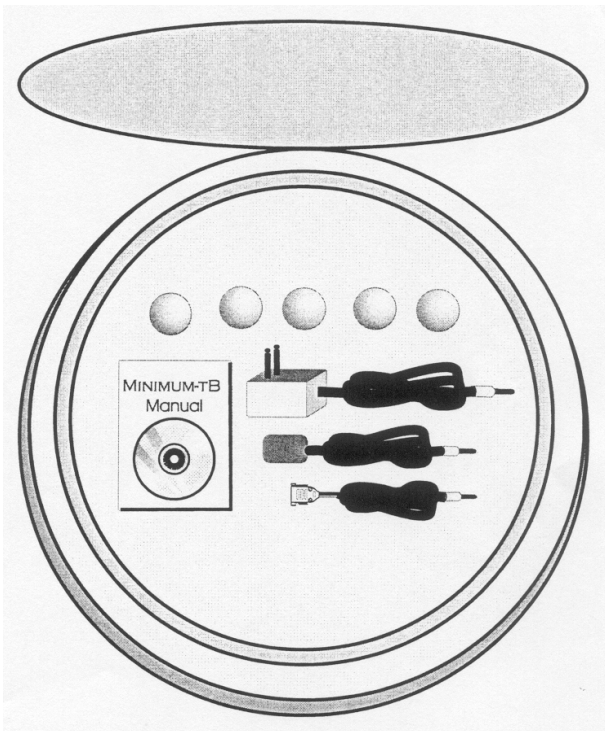

00854-03

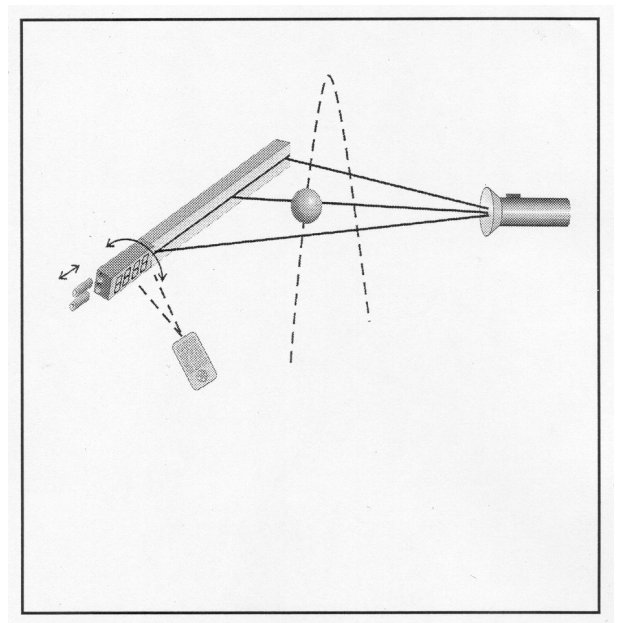
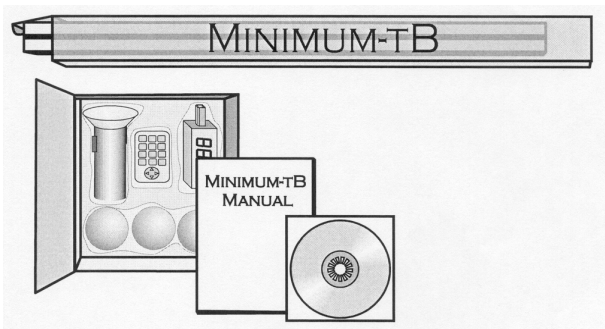

00854-04

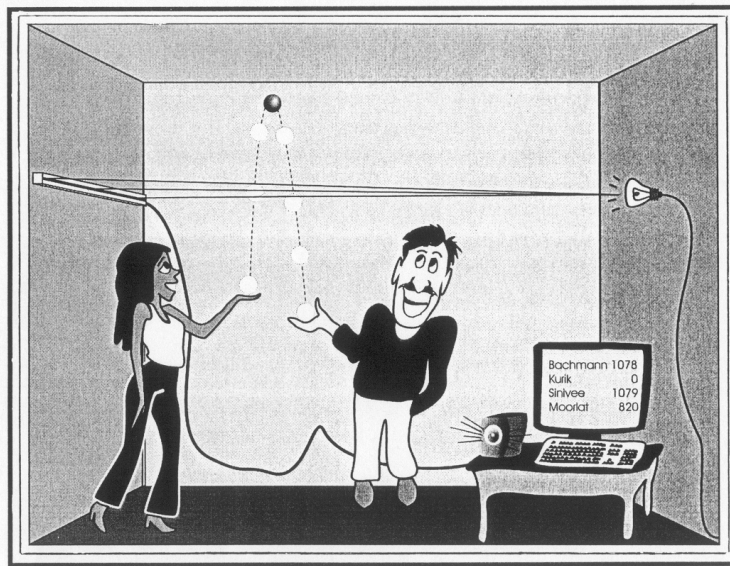
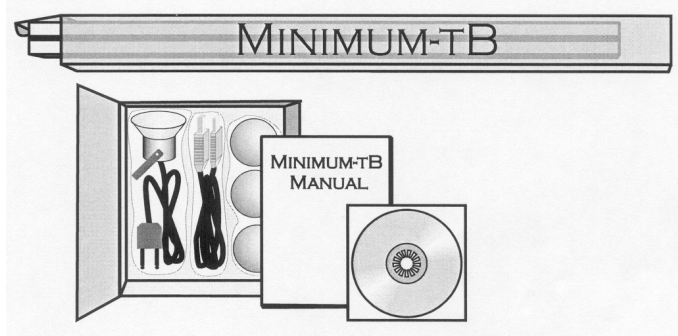

- (11) Registreeringu number: **00855**
- (15) Registreerimise kuupäev: 13.10.2003 (51) Klass: **02-06, 02-07**
- (21) Taotluse number: D200300082
- (22) Esitamise kuupäev: 11.06.2003
- (24) Registreeringu kehtivuse alguse kuupäev: 11.06.2003
- (28) Variantide arv: 6
- (72) Autor: Karoli Hindriks, Oravapesa, Laadi küla, Tahkuranna vald, 86502 Pärnu maakond, EE
- (73) Omanik: OÜ HEATUJU MAALETOOJA, Oravapesa, Laadi küla, Tahkuranna vald, 86502 Pärnu maakond, EE
- (74) Patendivolinik või ühine esindaja: Ott Moorlat

(54) Nimetus: **Helkuriga ratturikinnas**

(55) Reproduktsoon:

00855-01

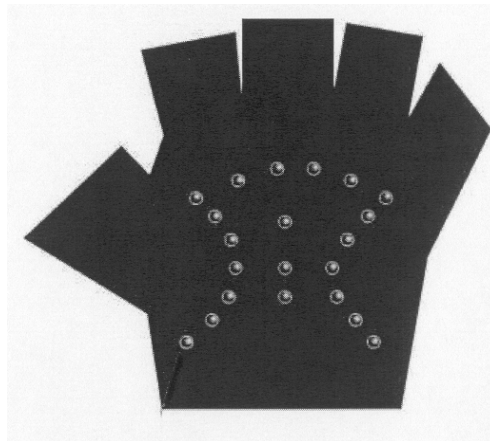
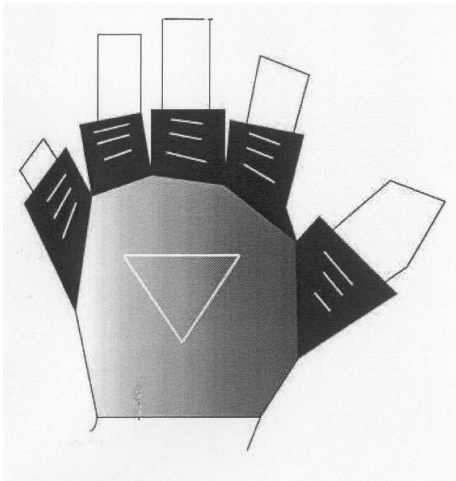

00855-02

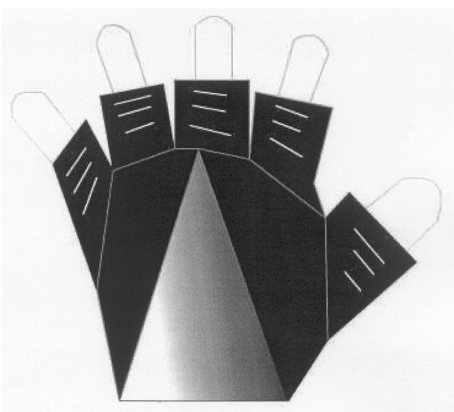

00855-03

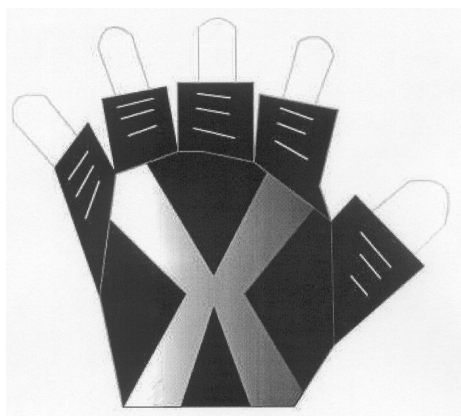

00855-04

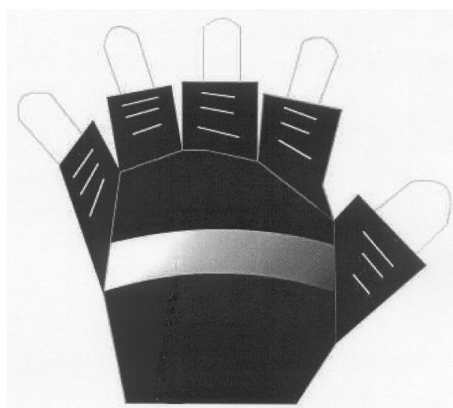

00855-05

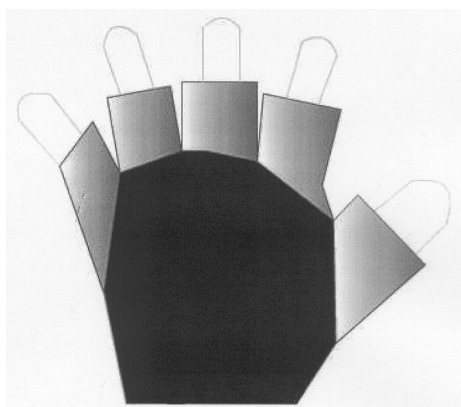

00855-06

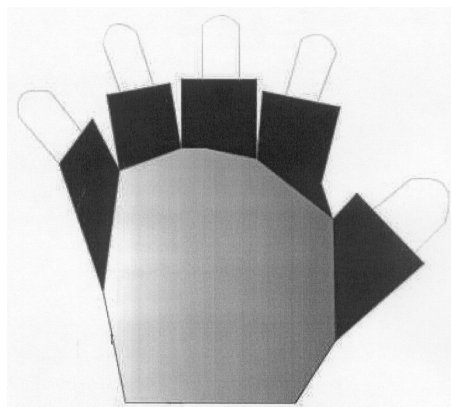



- (11) Registreeringu number: **00856**
- (15) Registreerimise kuupäev: 13.10.2003 (51) Klass: **23-02**
- (21) Taotluse number: D200300083
- (22) Esitamise kuupäev: 11.06.2003
- (24) Registreeringu kehtivuse alguse kuupäev: 11.06.2003
- (28) Variantide arv: 1
- (30) Prioriteediandmed: 402 10 318.1, 13.12.2002, DE
- (72) Autor: Andreas Haug, Franklinstr. 77, D-70435 Stuttgart, DE  
Tom Schönherr, Argonnenstr. 22, D-70374 Stuttgart, DE  
Fabian Kollmann, Kleine Falterstr. 21, D-70597 Stuttgart, DE  
Christian Stolarz, Raststr. 9, D-96450 Coburg, DE
- (73) Omanik: Hansgrohe AG, Auestrasse 5-9, D-77761 Schiltach, DE
- (74) Patendivolinik või ühine esindaja: Raivo Koitel

(54) Nimetus: **Seinale paigaldatav dušihoidik**

(55) Reproduktsoon:

00856-01



- (11) Registreeringu number: **00857**
- (15) Registreerimise kuupäev: 13.10.2003 (51) Klass: **06-01**
- (21) Taotluse number: D200300087
- (22) Esitamise kuupäev: 02.07.2003
- (24) Registreeringu kehtivuse  
alguse kuupäev: 02.07.2003
- (28) Variantide arv: 1
- (72) Autor: Raimo Sau, Liivamäe tee 8, Viimsi vald, 74001 Harju maakond, EE
- (73) Omanik: Raimo Sau, Liivamäe tee 8, Viimsi vald, 74001 Harju maakond, EE
- (74) Patendivolinik või ühine esindaja: Ott Moorlat

(54) Nimetus: **Tugitool**

(55) Reproduksioon:

00857-01

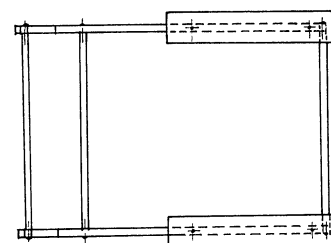
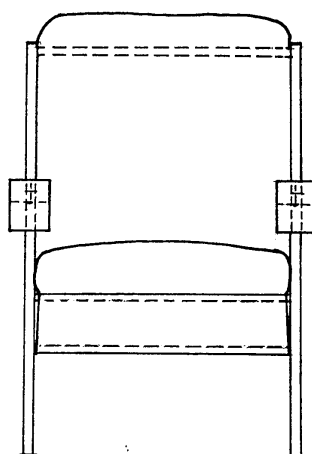
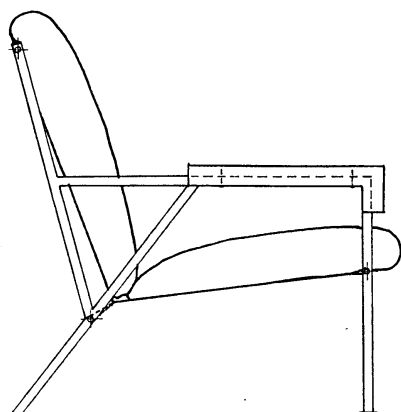

- (11) Registreeringu number: **00858**
- (15) Registreerimise kuupäev: 13.10.2003 (51) Klass: **09-08**
- (21) Taotluse number: D200300105
- (22) Esitamise kuupäev: 06.08.2003
- (24) Registreeringu kehtivuse alguse kuupäev: 06.08.2003
- (28) Variantide arv: 1
- (30) Prioriteediandmed: 03-0191, 11.02.2003, SE
- (72) Autor: Allan Dickner, Storkstigen 16, S-343 35 ÄLMHULT, SE
- (73) Omanik: Inter IKEA Systems B.V., Olof Palmestraat 1, NL-2616 LN DELFT, NL
- (74) Patendivolinik või ühine esindaja: Lembit Mitt

(54) Nimetus: **Laadimisdetail**

(55) Reproduksioon:

00858-01

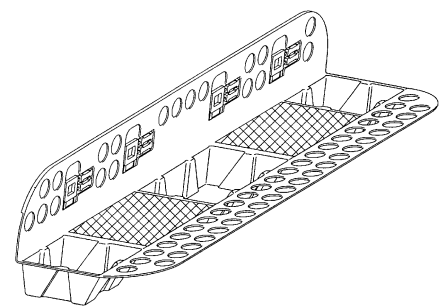
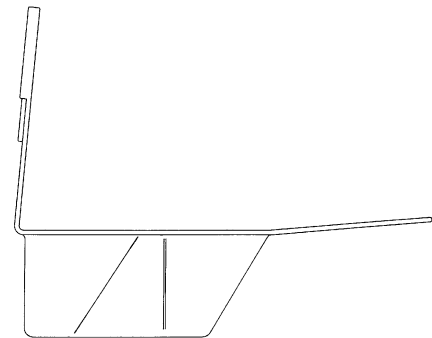
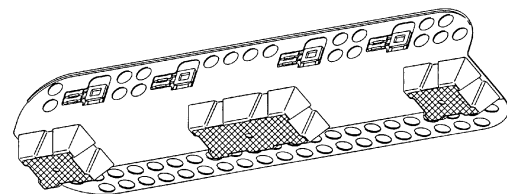
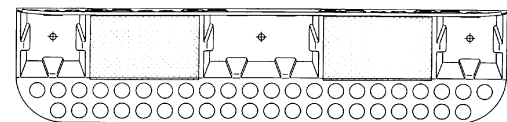
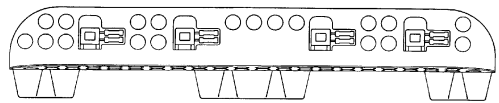
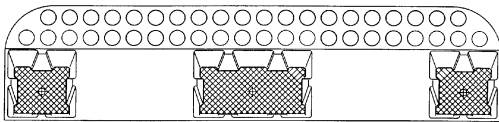

- (11) Registreeringu number: **00859**
- (15) Registreerimise kuupäev: 24.10.2003 (51) Klass: **13-02, 19-08**
- (21) Taotluse number: D200300038
- (22) Esitamise kuupäev: 06.03.2003
- (24) Registreeringu kehtivuse alguse kuupäev: 06.03.2003
- (28) Variantide arv: 1
- (30) Prioriteediandmed: M20020539, 06.09.2002, FI
- (72) Autor: Emma Hagman, Läntinen Pitkäkatu 29 B 24, 20100 Turku, FI  
Jussi Hovi, Pajontie 27, 24280 Salo, FI  
Nokia Corporation, Keilalahdentie 4, FIN-02150 Espoo, FI
- (73) Omanik: Nokia Corporation, Keilalahdentie 4, FIN-02150 Espoo, FI
- (74) Patendivolinik või ühine esindaja: Jüri Käosaar

(54) Nimetus: **Aku koos kleebisega**

(55) Reproduktsoon:

00859-01

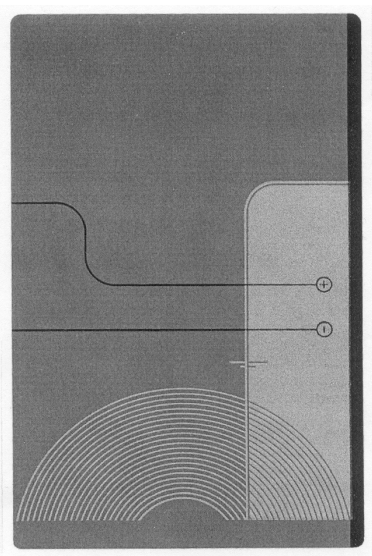
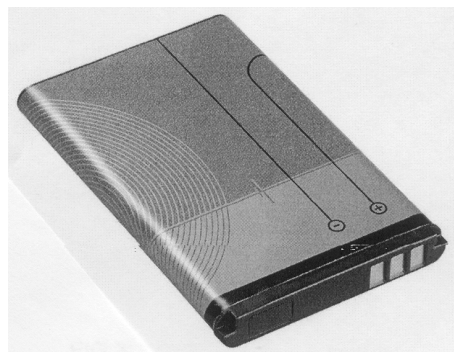
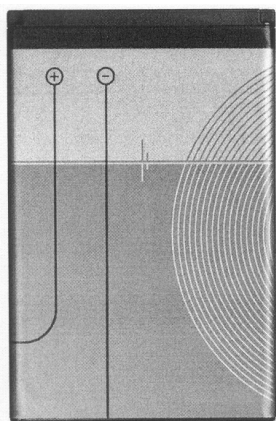

- (11) Registreeringu number: **00860**
- (15) Registreerimise kuupäev: 24.10.2003 (51) Klass: **23-02**
- (21) Taotluse number: D200300084
- (22) Esitamise kuupäev: 11.06.2003
- (24) Registreeringu kehtivuse alguse kuupäev: 11.06.2003
- (28) Variantide arv: 3
- (30) Prioriteediandmed: 402 10 283.5, 12.12.2002, DE
- (72) Autor: Andreas Haug, Franklinstr. 77, D-70435 Stuttgart, DE  
Tom Schönherr, Argonnenstr. 22, D-70374 Stuttgart, DE  
Fabian Kollmann, Kleine Falterstr. 21, D-70597 Stuttgart, DE
- (73) Omanik: Hansgrohe AG, Auestrasse 5-9, D-77761 Schiltach, DE
- (74) Patendivolinik või ühine esindaja: Raivo Koitel

(54) Nimetus: **Dušš**

(55) Reproduktsoon:

00860-01

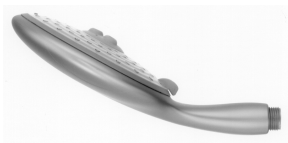
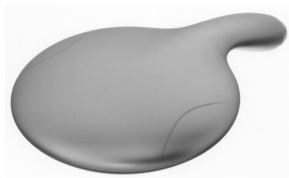

00860-02

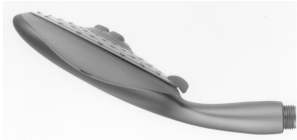
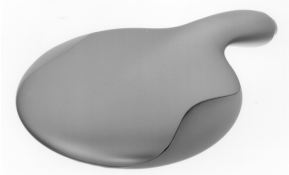

00860-03



- (11) Registreeringu number: **00861**
- (15) Registreerimise kuupäev: 24.10.2003 (51) Klass: **09-01**
- (21) Taotluse number: D200300101
- (22) Esitamise kuupäev: 24.07.2003
- (24) Registreeringu kehtivuse alguse kuupäev: 24.07.2003
- (28) Variantide arv: 1
- (30) Prioriteediandmed: 2003-029, 27.03.2003, LT - Fig 1
- (72) Autor: Eligijus Survila, Žygaičiã g. 18, LT-3032 Kaunas, LT
- (73) Omanik: Uždaroji akcinė bendrovė "SMS-Eligita", Draugystės g. 19, LT-3031 Kaunas, LT
- (74) Patendivolinik või ühine esindaja: Arvo Salumäe

(54) Nimetus: **Pudel**

(55) Reproduksioon:

00861-01

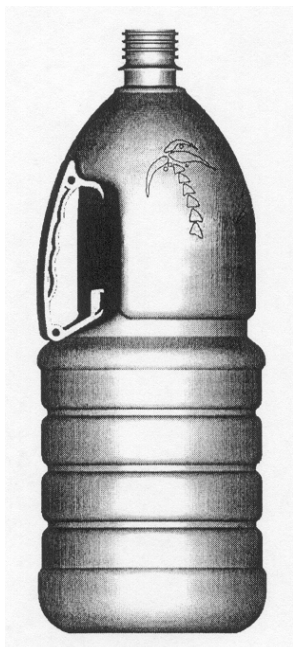

Fig. 1

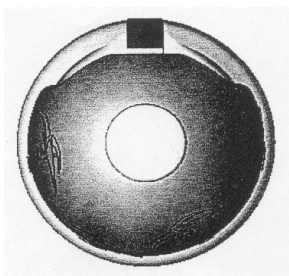

Fig. 2

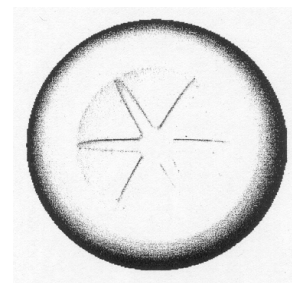

Fig. 3



- (11) Registreeringu number: **00862**
- (15) Registreerimise kuupäev: 24.10.2003 (51) Klass: **23-02**
- (21) Taotluse number: D200300106
- (22) Esitamise kuupäev: 15.09.2003
- (24) Registreeringu kehtivuse alguse kuupäev: 15.09.2003
- (28) Variantide arv: 1
- (30) Prioriteediandmed: 403 02 375.0, 21.03.2003, DE
- (72) Autor: Andreas Haug, Franklinstr. 77, D-70435 Stuttgart, DE  
Tom Schönherr, Argonnenstr. 22, D-70374 Stuttgart, DE  
Andreas Dimitriadis, In den Weingärten 14/1, D-73547 Lorch, DE  
Fabian Kollmann, Kleine Falterstr. 21, D-70597 Stuttgart, DE  
Hansgrohe AG, Auestrasse 5-9, D-77761 Schiltach, DE
- (73) Omanik: Hansgrohe AG, Auestrasse 5-9, D-77761 Schiltach, DE
- (74) Patendivolinik või ühine esindaja: Raivo Koitel

(54) Nimetus: **Käsidušš**

(55) Reproduksioon:

00862-01

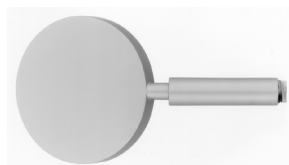
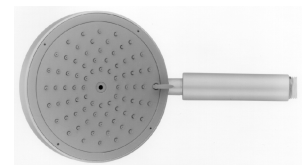

(11) Registreeringu number: **00863**

(15) Registreerimise kuupäev: 24.10.2003  
(21) Taotluse number: D200300107

(51) Klass: **09-01**

(22) Esitamise kuupäev: 18.09.2003

(24) Registreeringu kehtivuse  
alguse kuupäev: 18.09.2003

(28) Variantide arv: 2

(72) Autor: Martti Martin, Kolde pst 102-70, 10316 Tallinn, EE

(73) Omanik: Greiner Packaging Estonia AS, Rajakeskus 10, Tabasalu,  
76901 Harju maakond, EE

(74) Patendivolinik või ühine esindaja: Lembit Mitt

(54) Nimetus: **Pudel**

(55) Reproduksioon:

00863-01

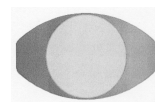
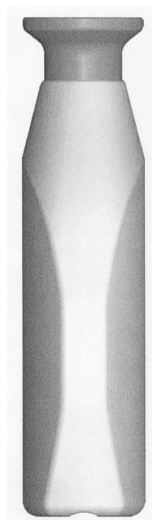
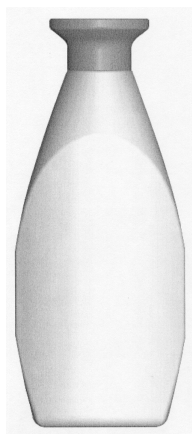

00863-02

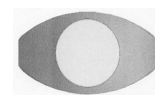
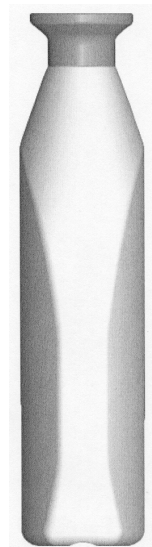
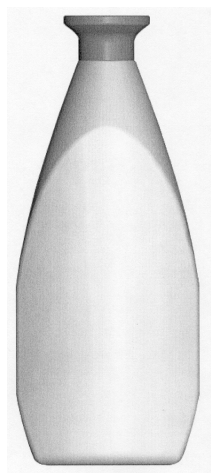
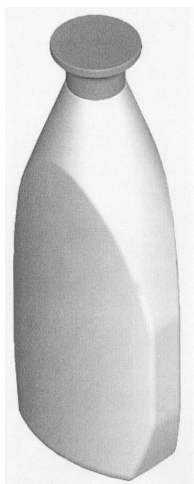

(11) Registreeringu number: **00864**

(15) Registreerimise kuupäev: 24.10.2003

(51) Klass: **13-02**

(21) Taotluse number: D200300108

(22) Esitamise kuupäev: 23.09.2003

(24) Registreeringu kehtivuse  
alguse kuupäev: 23.09.2003

(28) Variantide arv: 3

(72) Autor: Jaanus Tamme, Virmalise 9/36, 10131 Tallinn, EE

(73) Omanik: Telemark Hulgi OÜ, Laki 26, 12915 Tallinn, EE

(74) Patendivolinik või ühine esindaja: Ott Moorlat

(54) Nimetus: **Aku "TeleMark"**

(55) Reproduktsoon:

00864-01

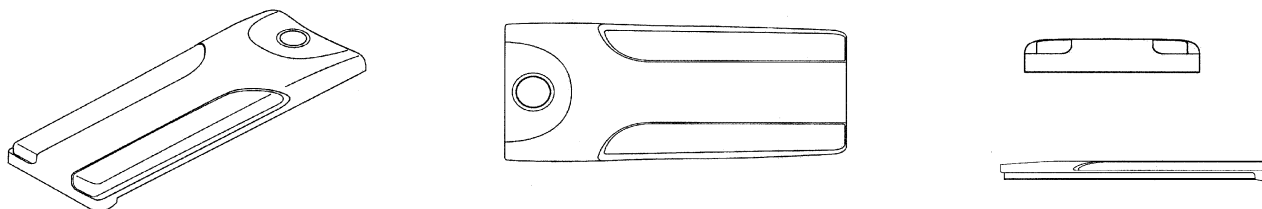

00864-02

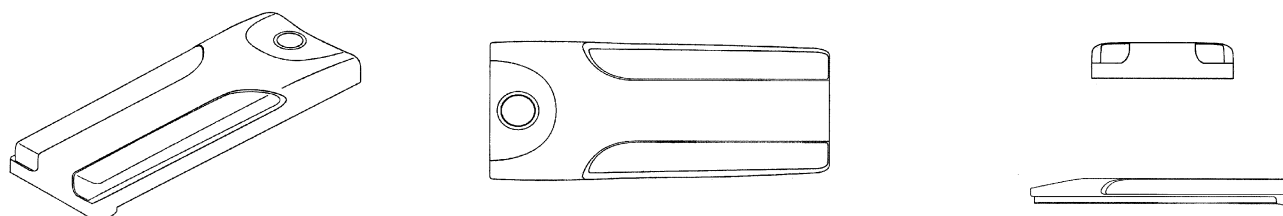

00864-03

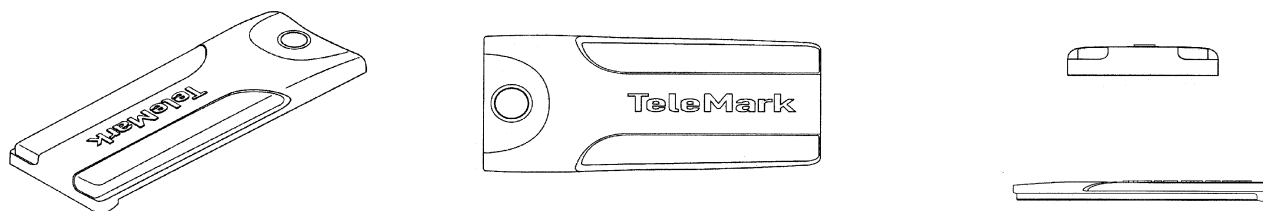

## II. TÖÖSTUSDISAINILAHENDUSE REGISTREERINGU KEHTIVUSE PIKENDAMINE

(11)	(18)
00304	12.08.2008
00305	12.08.2008
00309	18.09.2008
00310	18.09.2008
00311	22.09.2008
00312	22.09.2008
00320	03.09.2008
00321	08.10.2008
00326	03.12.2008
00329	03.12.2008
00330	03.12.2008
00331	03.12.2008
00338	10.12.2008
00356	27.10.2003
00365	24.03.2009
00366	24.03.2009

## III. TÖÖSTUSDISAINILAHENDUSE REGISTREERINGU ANDMETE MUUTMINE

Reg nr	Muudetud andmed	Registrikande jõustumise kuupäev
00826	(72) Ingemar Ragnarsson, c/o Metsä Tissue AB, 542 88 Mariestad, SE Jukka Virkasjärvi, c/o Metsä Tissue AB, 542 88 Mariestad, SE	26.08.2003

## V. TÖÖSTUSDISAINILAHENDUSE REGISTREERINGU KUSTUTAMINE

(11)
00216
00217
00218
00220
00221
00222
00223
00224
00225
00263
00292

## VI. TÖÖSTUSDISAINILAHENDUSE TUNNISTUSE DUPLIKAADI VÄLJASTAMINE

## VII. LOENDID

REGISTREERITUD TÖÖSTUSDISAINILAHENDUSTE  
SÜSTEMAATILINE LOEND

Rahvusvahelise klassifikatsiooni klass ja alaklass(id)	Registreerimis- taotluse number	Registreeringu number
--------------------------------------------------------------	------------------------------------	--------------------------

02-06, 02-07	D200300082	00855	14-03	D200300061	00837
04-02	D200300104	00846	14-03	D200300062	00838
06-01	D200300087	00857	14-03	D200300063	00839
09-01	D200300091	00844	14-03	D200300064	00840
09-01	D200300101	00861	14-03	D200300065	00841
09-01	D200300107	00863	14-03	D200300066	00847
09-03	D200300051	00854	14-03, 14-01	D200300067	00842
09-08	D200300105	00858	14-03	D200300095	00848
12-16	D200300103	00845	14-03	D200300096	00849
13-02, 19-08	D200300038	00859	14-03	D200300097	00850
13-02	D200300108	00864	14-03	D200300098	00851
14-03	D200300054	00830	14-03	D200300099	00852
14-03	D200300055	00831	14-03	D200300100	00853
14-03	D200300056	00832	23-02	D200300080	00843
14-03	D200300057	00833	23-02	D200300083	00856
14-03	D200300058	00834	23-02	D200300084	00860
14-03	D200300059	00835	23-02	D200300106	00862
14-03	D200300060	00836			

REGISTREERITUD TÖÖSTUSDISAINILAHENDUSTE REGISTREERIMISTAOTLUSTE  
NUMBRILINE LOEND

Registreerimis- taotluse number	Registreeringu number	Rahvusvahelise klassifikatsiooni klass(id) ja alaklass(id)
---------------------------------------	--------------------------	---------------------------------------------------------------------

D200300038	00859	13-02, 19-08	D200300083	00856	23-02
D200300051	00854	09-03	D200300084	00860	23-02
D200300054	00830	14-03	D200300087	00857	06-01
D200300055	00831	14-03	D200300091	00844	09-01
D200300056	00832	14-03	D200300095	00848	14-03
D200300057	00833	14-03	D200300096	00849	14-03
D200300058	00834	14-03	D200300097	00850	14-03
D200300059	00835	14-03	D200300098	00851	14-03
D200300060	00836	14-03	D200300099	00852	14-03
D200300061	00837	14-03	D200300100	00853	14-03
D200300062	00838	14-03	D200300101	00861	09-01
D200300063	00839	14-03	D200300103	00845	12-16
D200300064	00840	14-03	D200300104	00846	04-02
D200300065	00841	14-03	D200300105	00858	09-08
D200300066	00847	14-03	D200300106	00862	23-02
D200300067	00842	14-03, 14-01	D200300107	00863	09-01
D200300080	00843	23-02	D200300108	00864	13-02
D200300082	00855	02-06, 02-07			

## VIII. TÖÖSTUSDISAINIALASED ÕIGUSAKTID JA MUU INFO

RIIKLIKUS PATENDIVOLNIKE REGISTRIS REGISTREERITUD PATENDIVOLNIKE NIMEKIRI  
(seisuga 26. märts 2003)

Register on asutatud 1. septembril 2001. a Vabariigi Valitsuse 7. augusti 2001. a määrusega nr 271 "Riikliku patendivolinike registri asutamine ja registri pidamise põhimäärus" (RT I 2001, 70, 426) patendivoliniku seaduse § 21 alusel (RT I 2001, 27, 151).

## TEGEVUSVALDKOND: KAUBAMÄRK, TÖÖSTUSDISAINILAHENDUS JA GEOGRAAFILINE TÄHIS

<b>Arno ANIJALG</b>	<b>OÜ USTERVALL</b> Raekoja plats 16 51004 Tartu pk 21, 50002 Tartu telefon: (07) 441 980 telefaks: (07) 441 785 e-post: anijalg@ustervall.ee <a href="http://www.ustervall.ee">http://www.ustervall.ee</a> võõrkeeled: saksa, vene	<b>Uno JÄÄGER</b>	<b>Patendibüroo Käosaar &amp; Co OÜ</b> Rüütli 51A, 80010 Pärnu telefon: (044) 7 10 21 telefaks: (044) 7 10 01 GSM: 055 11 758 e-post: uno@estpak.ee <a href="http://www.kaosaar.ee">http://www.kaosaar.ee</a> võõrkeeled: inglise, soome, vene
<b>Aivo ARULA</b>	<b>Patendibüroo Käosaar &amp; Co OÜ</b> Tähe 94 50107 Tartu telefon: (07) 383 051 telefaks: (07) 383 055 e-post: info@kaosaar.ee <a href="http://www.kaosaar.ee">http://www.kaosaar.ee</a> võõrkeeled: inglise, vene	<b>Sirje KAHU</b>	<b>OÜ USTERVALL</b> Raekoja plats 16 51004 Tartu pk 21, 50002 Tartu telefon: (07) 441 980 telefaks: (07) 441 785 e-post: skahu@ustervall.ee <a href="http://www.ustervall.ee">http://www.ustervall.ee</a> võõrkeeled: inglise, vene
<b>Martina BÖCKLER</b>	<b>OÜ LASVET</b> Suurtüki 4a, 10133 Tallinn pk 3136, 10505 Tallinn telefon: 6 40 66 00 telefaks: 6 40 66 04 e-post: lasvet@lasvet.ee <a href="http://www.lasvet.ee">http://www.lasvet.ee</a> võõrkeeled: inglise, vene, soome	<b>Lembit KALEV</b>	<b>Patendibüroo ROOSILLA OÜ</b> Järveotsa tee 39-61 13520 Tallinn telefon: 657 1722; 657 5381 telefaks: 657 5381 GSM: 051 19 951 e-post: roosilla@roosilla.ee <a href="http://www.roosilla.ee">http://www.roosilla.ee</a> võõrkeeled: inglise, vene
<b>Alla HÄMMALOV</b>	<b>OÜ Intels</b> Riia 11-3 51010 Tartu telefon: (07) 42 04 01 telefaks: (07) 42 03 26 e-post: intels@estpak.ee võõrkeeled: inglise, poola, vene	<b>Urmas KAULER</b>	<b>Patendibüroo TURVAJA OÜ</b> Kaupmehe 8 10114 Tallinn telefon: 6 40 31 09 telefaks: 6 40 31 05 e-post: kauler@turvaja.ee <a href="http://www.turvaja.ee">http://www.turvaja.ee</a> võõrkeeled: inglise, vene, soome
<b>Juhan HÄMMALOV</b>	<b>OÜ Intels</b> Riia 11-3 51010 Tartu telefon: (07) 42 04 01 telefaks: (07) 42 03 26 e-post: intels@estpak.ee võõrkeeled: inglise, saksa, vene	<b>Urmas KERNU</b>	<b>AAA Patendibüroo OÜ</b> Tartu mnt 16 10117 Tallinn pk 3926, 10509 Tallinn telefon: 660 5910, 660 5911 telefaks: 660 5912 e-post: aaa@aaa.ee <a href="http://www.aaa.ee">http://www.aaa.ee</a> võõrkeeled: inglise, saksa, soome, vene

- Ljubov KESSELMAN** **OÜ Kesna**  
 Tedre 77-52  
 10616 Tallinn  
 telefon: 6 608 068  
 telefaks: 6 608 069  
 e-post: kesna@online.ee  
 võõrkeeled: inglise, vene
- Marina KESSELMAN** **OÜ Kesna**  
 Tedre 77-52  
 10616 Tallinn  
 telefon: 6 608 068  
 telefaks: 6 608 069  
 e-post: kesna@online.ee  
 võõrkeeled: inglise, saksa, vene
- Heinu KOITEL** **Patendi- & Kaubamärgibüroo Koitel OÜ**  
 Tartu mnt 65  
 10115 Tallinn  
 pk 1759, 10902 Tallinn  
 telefon: 6 033 260  
 telefaks: 6 033 261  
 e-post: koitel@koitel.ee  
<http://www.koitel.ee>  
 võõrkeeled: inglise, soome, vene
- Raivo KOITEL** **Patendi- & Kaubamärgibüroo Koitel OÜ**  
 Tartu mnt 65  
 10115 Tallinn  
 pk 1759, 10902 Tallinn  
 telefon: 6 033 260  
 telefaks: 6 033 261  
 e-post: koitel@koitel.ee  
<http://www.koitel.ee>  
 võõrkeeled: inglise, soome, vene
- Mart-Enn KOPPEL** kontaktandmed:  
 OÜ Advokaadibüroo Andrus Lillo  
 Rüütli 14, 51007 Tartu  
 telefon: (07) 303 470;  
 (07) 303 472  
 telefaks: (07) 303 471  
 e-post: martenn.koppel@mail.ee  
 e-post: mail@advokaadid.ee  
[http://www.advokaadid.ee/index\\_ee.htm](http://www.advokaadid.ee/index_ee.htm)  
 võõrkeeled: inglise, vene, soome
- Heinrich KRUPP** **Patendibüroo TURVAJA OÜ**  
 Kaupmehe 8  
 10114 Tallinn  
 telefon: 6 40 31 09  
 telefaks: 6 40 31 05  
 e-post: turvaja@turvaja.ee  
<http://www.turvaja.ee>  
 võõrkeeled: saksa, vene
- Jüri KÄOSAAR** **Patendibüroo Käosaar & Co OÜ**  
 Tähe 94  
 50107 Tartu  
 telefon: (07) 383 051  
 telefaks: (07) 383 055  
 e-post: info@kaosaar.ee  
<http://www.kaosaar.ee>  
 võõrkeeled: inglise, vene
- Reet MAASIKAMÄE** **OÜ Kaitsepurus**  
 Mulla 4-3  
 10611 Tallinn  
 telefon: 6 739 097 &  
 6 332 798  
 telefaks: 6 774 844  
 e-post: purus@online.ee &  
 purus@hot.ee  
<http://www.hot.ee/purus/>  
 võõrkeeled: inglise, vene
- Raivo MATSOO** **RM Hirvela Patendibüroo OÜ**  
 Saku 15, 11314 Tallinn  
 telefon: 6 140 816  
 telefaks: 6 140 818  
 e-post: hirvela@online.ee  
 võõrkeeled: inglise, vene
- Elle MELLIK** **AAA Patendibüroo OÜ**  
 Tartu mnt 16  
 10117 Tallinn  
 pk 3926, 10509 Tallinn  
 telefon: 660 5910, 660 5911  
 telefaks: 660 5912  
 e-post: aaa@aaa.ee  
<http://www.aaa.ee>  
 võõrkeeled: inglise, vene
- Lembit MITT** **AAA Patendibüroo OÜ**  
 Tartu mnt 16  
 10117 Tallinn  
 pk 3926, 10509 Tallinn  
 telefon: 660 5910, 660 5911  
 telefaks: 660 5912  
 e-post: aaa@aaa.ee  
<http://www.aaa.ee>  
 võõrkeeled: inglise, vene
- Ott MOORLAT** **OÜ Moorlat & Ko Patendibüroo**  
 pk 723, 12902 Tallinn  
 telefon: 655 0450 & 654 2844  
 telefaks: 654 2844  
 e-post: ott.moorlat@moorlat.ee  
<http://www.moorlat.ee>  
 võõrkeeled: inglise, vene

- Anfia MORNA**      **Patendibüroo TURVAJA OÜ**  
 Kaupmehe 8, 10114 Tallinn  
 telefon: 6 40 31 09  
 telefaks: 6 40 31 05  
 e-post: morna@turvaja.ee  
<http://www.turvaja.ee>  
 võõrkeeled: inglise, vene
- Tõnu NELNAS**      **AAA Patendibüroo OÜ**  
 Tartu mnt 16  
 10117 Tallinn  
 pk 3926, 10509 Tallinn  
 telefon: 660 5910, 660 5911  
 telefaks: 660 5912  
 e-post: aaa@aaa.ee  
<http://www.aaa.ee>  
 võõrkeeled: inglise, vene, soome
- Jüri OLT**      **Patendibüroo Käosaar & Co OÜ**  
 Tähe 94, 50107 Tartu  
 telefon: (07) 383 051  
 telefaks: (07) 383 055  
 e-post: info@kaosaar.ee  
<http://www.kaosaar.ee>  
 võõrkeeled: inglise, saksa, soome, vene
- Jaak OSTRAT**      **OÜ LASVET**  
 Suurtüki 4a, 10133 Tallinn  
 pk 3136, 10505 Tallinn  
 telefon: 6 40 66 00  
 telefaks: 6 40 66 04  
 e-post: lasvet@lasvet.ee  
<http://www.lasvet.ee>  
 võõrkeeled: inglise, saksa, soome, vene
- Villu PAVELTS**      **OÜ LASVET**  
 Suurtüki 4a, 10133 Tallinn  
 pk 3136, 10505 Tallinn  
 telefon: 6 40 66 00  
 telefaks: 6 40 66 04  
 e-post: lasvet@lasvet.ee  
<http://www.lasvet.ee>  
 võõrkeeled: inglise, soome, vene
- Anneli PUNGAS**      **OÜ Synest**  
 pk 977, 13402 Tallinn  
 telefon: 6 609 786  
 telefaks: 6 609 787  
 e-post: anneli@synest.ee  
 võõrkeeled: inglise, saksa, vene, prantsuse, soome, rootsi
- Toom PUNGAS**      **OÜ Synest**  
 pk 977, 13402 Tallinn  
 telefon: 6 609 786  
 telefaks: 6 609 787  
 e-post: toom@synest.ee  
 võõrkeeled: inglise, saksa, soome, vene
- Kaie PUUR**      **Patendibüroo Käosaar & Co OÜ**  
 Tähe 94  
 50107 Tartu  
 telefon: (07) 383 051  
 telefaks: (07) 383 055  
 e-post: info@kaosaar.ee  
<http://www.kaosaar.ee>  
 võõrkeeled: inglise, vene
- Tarmo ROSMAN**      **Rosman ja Partnerid OÜ**  
 pk 652, 12602 Tallinn  
 telefon: 656 14 50  
 telefaks: 656 14 50  
 e-post: tarman@cc.ttu.ee  
 võõrkeeled: saksa, inglise, ungari, vene
- Arvo SALUMÄE**      **OÜ Amende Patendibüroo**  
 Raua 65  
 10152 Tallinn  
 telefon: 6 486 125  
 telefaks: 6 410 174  
 e-post: amende@hot.ee  
 võõrkeeled: inglise, saksa, soome, vene
- Harald TEHVER**      **Patendibüroo TURVAJA OÜ**  
 Kaupmehe 8  
 10114 Tallinn  
 telefon: 6 40 31 09  
 telefaks: 6 40 31 05  
 e-post: tehver@turvaja.ee  
<http://www.turvaja.ee>  
 võõrkeeled: inglise, saksa, vene
- Olga TREUFELDT**      **Patendibüroo TURVAJA OÜ**  
 Kaupmehe 8  
 10114 Tallinn  
 telefon: 6 40 31 09  
 telefaks: 6 40 31 05  
 e-post: olga@turvaja.ee  
<http://www.turvaja.ee>  
 võõrkeeled: inglise, vene
- Enn URGAS**      **Patendibüroo TURVAJA OÜ**  
 Kaupmehe 8  
 10114 Tallinn  
 telefon: 6 40 31 09  
 telefaks: 6 40 31 05  
 e-post: urgas@turvaja.ee  
<http://www.turvaja.ee>  
 võõrkeeled: inglise, vene
- Juta-Maris UUSTALU**      **OÜ LASVET**  
 Suurtüki 4a, 10133 Tallinn  
 pk 3136, 10505 Tallinn  
 telefon: 6 40 66 00  
 telefaks: 6 40 66 04  
 e-post: lasvet@lasvet.ee  
<http://www.lasvet.ee>  
 võõrkeeled: inglise, vene



**LIST OF PATENT ATTORNEYS, REGISTERED IN  
THE ESTONIAN STATE REGISTER OF PATENT ATTORNEYS  
(by 26 March 2003)**

Register is established on September 1<sup>st</sup> 2001

**FIELD OF ACTIVITY: TRADEMARKS, INDUSTRIAL DESIGNS AND GEOGRAPHICAL INDICATIONS**

<b>Arno ANIJALG</b>	<b>USTERVALL Ltd.</b> Raekoja plats 16 51004 Tartu P.O. Box 21 50002 Tartu, Estonia Phone: (372 7) 441 980 Fax: (372 7) 441 785 E-mail: anijalg@ustervall.ee Http://www.ustervall.ee German, Russian, Estonian	<b>Uno JÄÄGER</b>	<b>Patent Agency Käosaar &amp; Co</b> Rüütli 51A 80010 Pärnu, Estonia Phone: (372 44) 7 10 21 Fax: (372 44) 7 10 01 GSM: (372) 55 11 758 E-mail: uno@estpak.ee Http://www.kaosaar.ee English, Finnish, Russian, Estonian
<b>Aivo ARULA</b>	<b>Patent Agency Käosaar &amp; Co</b> Tähe Str. 94 50107 Tartu, Estonia Phone: (372 7) 383 051 Fax: (372 7) 383 055 E-mail: info@kaosaar.ee Http://www.kaosaar.ee English, Russian, Estonian	<b>Sirje KAHU</b>	<b>USTERVALL Ltd.</b> Raekoja plats 16 51004 Tartu P.O. Box 21 50002 Tartu, Estonia Phone: (372 7) 441 980 Fax: (372 7) 441 785 E-mail: skahu@ustervall.ee Http://www.ustervall.ee English, Russian, Estonian
<b>Martina BÖCKLER</b>	<b>Lasvet Ltd.</b> P.O. Box 3136, 10505 Tallinn, Estonia Phone: (372) 6 40 66 00 Fax: (372) 6 40 66 04 E-mail: lasvet@lasvet.ee Http://www.lasvet.ee English, Russian, Finnish, Estonian	<b>Lembit KALEV</b>	<b>Patent Bureau ROOSILLA Ltd.</b> Järveotsa Road 39-61 13520 Tallinn, Estonia Phone: (372) 657 1722; (372) 657 5381 Fax: (372) 657 5381 GSM: (372) 51 19 951 E-mail: roosilla@roosilla.ee Http://www.roosilla.ee English, Russian, Estonian
<b>Alla HÄMMALOV</b>	<b>Intels Ltd.</b> Riia Str. 11-3 51010 Tartu, Estonia Phone: (372 7) 42 04 01 Fax: (372 7) 42 03 26 E-mail: intelses@estpak.ee English, Polish, Russian, Estonian	<b>Urmas KAULER</b>	<b>Patendibüroo TURVAJA OÜ</b> Kaupmehe Str. 8 10114 Tallinn, Estonia Phone: (372) 6 40 31 09 Fax: (372) 6 40 31 05 E-mail: kauler@turvaja.ee Http://www.turvaja.ee English, Russian, Finnish, Estonian
<b>Juhan HÄMMALOV</b>	<b>Intels Ltd.</b> Riia Str. 11-3 51010 Tartu, Estonia Phone: (372 7) 42 04 01 Fax: (372 7) 42 03 26 E-mail: intelses@estpak.ee English, German, Russian, Estonian		

- Urmast KERNU**      **AAA Legal Services**  
Tartu Road 16  
10117 Tallinn, Estonia  
P.O. Box 3926  
10509 Tallinn, Estonia  
Phone: (372) 660 5910,  
(372) 660 5911  
Fax: (372) 660 5912  
E-mail: aaa@aaa.ee  
Http://www.aaa.ee  
English, German, Finnish,  
Russian, Estonian
- Mart-Enn KOPPEL**      Law Office Andrus Lillo  
Rüütli 14, 51007 Tartu, Estonia  
Phone: (372 7) 303 470;  
(372 7) 303 472  
Fax: (372 7) 303 471  
E-mail: martenn.koppel@mail.ee  
E-mail: mail@advokaadid.ee  
Http://www.advokaadid.ee/index\_en.htm  
English, Russian, Finnish,  
Estonian
- Marina KESSELMAN**      **Kesna Ltd.**  
Tedre Str. 77-52  
10616 Tallinn, Estonia  
Phone: (372) 6 608 068  
Fax: (372) 6 608 069  
E-mail: kesna@online.ee  
English, German, Russian,  
Estonian
- Heinu KOITEL**      **Patent- & Trademark Office  
Koitel Ltd.**  
Tartu Road 65  
10115 Tallinn  
P.O. Box 1759, 10902 Tallinn  
Phone: (372) 6 033 260  
Fax: (372) 6 033 261  
E-mail: koitel@koitel.ee  
Http://www.koitel.ee  
English, Finnish, Russian,  
Estonian
- Raivo KOITEL**      **Patent- & Trademark Office  
Koitel Ltd.**  
Tartu Road 65  
10115 Tallinn  
P.O. Box 1759, 10902 Tallinn  
Phone: (372) 6 033 260  
Fax: (372) 6 033 261  
E-mail: koitel@koitel.ee  
Http://www.koitel.ee  
English, Finnish, Russian,  
Estonian
- Heinrich KRUPP**      **Patendibüroo TURVAJA OÜ**  
Kaupmehe Str. 8  
10114 Tallinn, Estonia  
Phone: (372) 6 40 31 09  
Fax: (372) 6 40 31 05  
E-mail: turvaja@turvaja.ee  
Http://www.turvaja.ee  
German, Russian, Estonian
- Jüri KÄOSAAR**      **Patent Agency Käosaar & Co**  
Tähe Str. 94  
50107 Tartu, Estonia  
Phone: (372 7) 383 051  
Fax: (372 7) 383 055  
E-mail: info@kaosaar.ee  
Http://www.kaosaar.ee  
English, Russian, Estonian
- Reet MAASIKAMÄE**      **Patent Bureau Kaitsepurus  
Ltd.**  
Mulla Str. 4-3  
10611 Tallinn, Estonia  
Phone: (372) 6 739 097 &  
(372) 6 332 798  
Fax: (372) 6 774 844  
E-mail: purus@online.ee &  
purus@hot.ee  
Http://www.hot.ee/purus/  
English, Russian, Estonian
- Raivo MATSOO**      **RM Hirvela Patent Bureau  
Ltd**  
Saku 15, 11314 Tallinn  
Phone: (372) 6 140 816  
Fax: (372) 6 140 818  
E-mail: hirvela@online.ee  
English, Russian, Estonian
- Elle MELLIK**      **AAA Legal Services**  
Tartu Road 16  
10117 Tallinn, Estonia  
P.O. Box 3926  
10509 Tallinn, Estonia  
Phone: (372) 660 5910,  
(372) 660 5911  
Fax: (372) 660 5912  
E-mail: aaa@aaa.ee  
Http://www.aaa.ee  
English, Russian, Estonian

<b>Lembit MITT</b>	<b>AAA Legal Services</b> Tartu Road 16 10117 Tallinn, Estonia P.O. Box 3926 10509 Tallinn, Estonia Phone: (372) 660 5910, (372) 660 5911 Fax: (372) 660 5912 E-mail: aaa@aaa.ee Http://www.aaa.ee English, Russian, Estonian	<b>Jaak OSTRAT</b>	<b>Lasvet Ltd.</b> P.O. Box 3136, 10505 Tallinn, Estonia Phone: (372) 6 40 66 00 Fax: (372) 6 40 66 04 E-mail: lasvet@lasvet.ee Http://www.lasvet.ee English, German, Finnish, Russian, Estonian
<b>Ott MOORLAT</b>	<b>Moorlat &amp; Co Ltd.</b> <b>Patent Bureau</b> P.O. Box 723 12902 Tallinn, Estonia Phone: (372) 655 0450 & (372) 654 2844 Fax: (372) 654 2844 E-mail: ott.moorlat@moorlat.ee Http://www.moorlat.ee English, Russian, Estonian	<b>Villu PAVELTS</b>	<b>Lasvet Ltd.</b> P.O. Box 3136 10505 Tallinn, Estonia Phone: (372) 6 40 66 00 Fax: (372) 6 40 66 04 E-mail: lasvet@lasvet.ee Http://www.lasvet.ee English, Finnish, Russian, Estonian
<b>Anfia MORNA</b>	<b>Patendibüroo TURVAJA OÜ</b> Kaupmehe Str. 8 10114 Tallinn, Estonia Phone: (372) 6 40 31 09 Fax: (372) 6 40 31 05 E-mail: morna@turvaja.ee Http://www.turvaja.ee English, Russian, Estonian	<b>Anneli PUNGAS</b>	<b>Synest Ltd.</b> P.O. Box 977 13402 Tallinn, Estonia Phone: (372) 6 609 786 Fax: (372) 6 609 787 E-mail: anneli@synest.ee English, German, Russian, French, Finnish, Swedish, Estonian
<b>Tõnu NELSAS</b>	<b>AAA Legal Services</b> Tartu Road 16 10117 Tallinn, Estonia P.O. Box 3926 10509 Tallinn, Estonia Phone: (372) 660 5910, (372) 660 5911 Fax: (372) 660 5912 E-mail: aaa@aaa.ee Http://www.aaa.ee English, Russian, Finnish, Estonian	<b>Toom PUNGAS</b>	<b>Synest Ltd.</b> P.O. Box 977 13402 Tallinn, Estonia Phone: (372) 6 609 786 Fax: (372) 6 609 787 E-mail: toom@synest.ee English, German, Finnish, Russian, Estonian
<b>Jüri OLT</b>	<b>Patent Agency Käosaar &amp; Co</b> Tähe Str. 94 50107 Tartu, Estonia Phone: (372 7) 383 051 Fax: (372 7) 383 055 E-mail: info@kaosaar.ee Http://www.kaosaar.ee English, German, Finnish, Russian, Estonian	<b>Kaie PUUR</b>	<b>Patent Agency Käosaar &amp; Co</b> Tähe Str. 94 50107 Tartu, Estonia Phone: (372 7) 383 051 Fax: (372 7) 383 055 E-mail: info@kaosaar.ee Http://www.kaosaar.ee English, Russian, Estonian
		<b>Tarmo ROSMAN</b>	<b>Rosman and Partners Ltd.</b> P.O. Box 652 12602 Tallinn, Estonia Phone: (372) 656 14 50 Fax: (372) 656 14 50 E-mail: tarman@cc.ttu.ee German, English, Hungarian, Russian, Estonian

**Arvo SALUMÄE****AMENDE Patent Agency Ltd.**

Raua 65, 10152 Tallinn, Estonia  
Phone: (372) 6 486 125  
Fax: (372) 6 410 174  
E-mail: amende@hotmail.ee  
English, German, Finnish,  
Russian, Estonian

**Enn URGAS****Patendibüroo TURVAJA OÜ**

Kaupmehe Str. 8  
10114 Tallinn, Estonia  
Phone: (372) 6 40 31 09  
Fax: (372) 6 40 31 05  
E-mail: urgas@turvaja.ee  
Http://www.turvaja.ee  
English, Russian, Estonian

**Harald TEHVER****Patendibüroo TURVAJA OÜ**

Kaupmehe Str. 8  
10114 Tallinn, Estonia  
Phone: (372) 6 40 31 09  
Fax: (372) 6 40 31 05  
E-mail: tehver@turvaja.ee  
Http://www.turvaja.ee  
English, German, Russian,  
Estonian

**Juta-Maris UUSTALU****Lasvet Ltd.**

P.O. Box 3136  
10505 Tallinn, Estonia  
Phone: (372) 6 40 66 00  
Fax: (372) 6 40 66 04  
E-mail: lasvet@lasvet.ee  
Http://www.lasvet.ee  
English, Russian, Estonian

**Olga TREUFELDT****Patendibüroo TURVAJA OÜ**

Kaupmehe Str. 8  
10114 Tallinn, Estonia  
Phone: (372) 6 40 31 09  
Fax: (372) 6 40 31 05  
E-mail: olga@turvaja.ee  
Http://www.turvaja.ee  
English, Russian, Estonian

**RIIKIDE, TEISTE ÜHENDUSTE JA VALITSUSTEVAAHELISTE  
ORGANISATSIOONIDE KOODID**

AD	Andorra	CN	Hiina	GW	Guinea-Bissau
AE	Araabia Ühendemiraadid	CO	Kolumbia	GY	Guyana
AF	Afganistan	CR	Costa Rica	HK	Hongkong
AG	Antigua ja Barbuda	CS	Serbia ja Montenegro	HN	Honduras
AI	Anguilla	CU	Kuuba	HR	Horvaatia
AL	Albaania	CV	Cabo Verde	HT	Haiti
AM	Armeenia	CY	Küpros	HU	Ungari
AN	Hollandi Antillid	CZ	Tšehhi	IB	Ülemaailmse Intellektuaalomandi
AO	Angola	DE	Saksamaa		Organisatsiooni (WIPO)
AP	Aafrika Regionaalne Tööstusomandi Organisatsioon (ARIPO)	DJ	Djibouti		Rahvusvaheline Büroo
AR	Argentina	DK	Taani	ID	Indoneesia
AS	Ameerika Samoa	DM	Dominica	IE	Iiri
AT	Austria	DO	Dominikaani Vabariik	IL	Iisrael
AU	Austraalia	DZ	Alžeeria	IM	Man'i saar
AW	Aruba	EA	Euraasia Patendiorganisatsioon (EAPO)	IN	India
AZ	Aserbaidžaan	EC	Ecuador	IQ	Iraak
BA	Bosnia ja Hertsegoviina	EE	Eesti	IR	Iraan
BB	Barbados	EG	Egiptus	IS	Island
BD	Bangladesh	EH	Lääne-Sahara	IT	Itaalia
BE	Belgia	EM	Siseturu Ühtlustamise Amet (kaubamärgid ja tööstusdisainilahendused)	JM	Jamaica
BF	Burkina Faso			JO	Jordaania
BG	Bulgaaria	EP	Euroopa Patendiamet (EPO)	JP	Jaapan
BH	Bahrein	ER	Eritrea	KE	Kenya
BI	Burundi	ES	Hispaania	KG	Kõrgõzstan
BJ	Benin	ET	Etiopia	KH	Kambodža
BM	Bermuda	FI	Soome	KI	Kiribati
BN	Brunei	FJ	Fidži	KM	Komoorid
BO	Boliivia	FK	Falklandi (Malviini) saared	KN	Saint Kitts ja Nevis
BR	Brasiilia	FM	Mikroneesia	KP	Põhja-Korea
BS	Bahama	FO	Fääri saared	KR	Lõuna-Korea
BT	Bhutan	FR	Prantsusmaa	KW	Kuveit
BV	Bouvet' saar	GA	Gabon	KY	Kaimanisaared
BW	Botswana	GB	Ühendkuningriik (Suurbritannia)	KZ	Kasahstan
BX	Beneluxi Kaubamärgiamet (BBM) ja Beneluxi Tööstusdisaini- lahenduste Amet (BBDM)	GD	Grenada	LA	Laos
BY	Valgevene	GE	Gruusia	LB	Liibanon
BZ	Belize	GH	Ghana	LC	Saint Lucia
CA	Kanada	GI	Gibraltar	LI	Liechtenstein
CF	Kesk-Aafrika Vabariik	GL	Gröönimaa	LK	Sri Lanka
CG	Kongo	GM	Gambia	LR	Libeeria
CH	Šveits	GN	Guinea	LS	Lesotho
CI	Côte d'Ivoire	GQ	Ekvatoriaal-Guinea	LT	Leedu
CK	Cooki saared	GR	Kreeka	LU	Luksemburg
CL	Tšiili	GS	Lõuna-Georgia ja Lõuna-Sandwichi saared	LV	Läti
CM	Kamerun	GT	Guatemala	LY	Liibüa
				MA	Maroko
				MC	Monaco
				MD	Moldova
				MG	Madagaskar
				MH	Marshalli Saared
				MK	Makedoonia
				ML	Mali
				MM	Myanmar (Birma)

MN	Mongoolia	PT	Portugal	TN	Tuneesia
MO	Macao	PW	Belau	TO	Tonga
MP	Põhja-Mariaanid	PY	Paraguay	TL	Ida-Timor
MR	Mauritaania	QA	Katar	TR	Türgi
MS	Montserrat	RO	Rumeenia	TT	Trinidad ja Tobago
MT	Malta	RU	Venemaa	TV	Tuvalu
MU	Mauritius	RW	Rwanda	TW	Taiwan (Hiina provints)
MV	Maldiivid	SA	Saudi Araabia	TZ	Tansaania
MW	Malawi	SB	Saalomoni Saared	UA	Ukraina
MX	Mehhiko	SC	Seišellid	UG	Uganda
MY	Malaisia	SD	Sudaan	US	Ameerika Ühendriigid
MZ	Mosambiik	SE	Rootsi	UY	Uruguay
NA	Namiibia	SG	Singapur	UZ	Usbekistan
NE	Niger	SH	Saint Helena	VA	Vatikan (Püha Tool)
NG	Nigeeria	SI	Sloveenia	VC	Saint Vincent ja Grenadiinid
NI	Nicaragua	SK	Slovakkia	VE	Venezuela
NL	Holland	SL	Sierra Leone	VG	Neitsisaared
NO	Norra	SM	San Marino	VN	Vietnam
NP	Nepal	SN	Senegal	VU	Vanuatu
NR	Nauru	SO	Somaalia	WO	Ülemaailmne
NZ	Uus-Meremaa	SR	Suriname		Intellektuaalomandi
OA	Aafrika	ST	São Tomé ja Príncipe		Organisatsioon (WIPO)
	Intellektuaalomandi	SV	El Salvador		(Rahvusvaheline Büroo)
	Organisatsioon (OAPI)	SY	Süüria		
OM	Omaan	SZ	Svaasimaa	WS	Samoa
PA	Panama	TC	Turks ja Caicos	YE	Jeemen
PE	Peruu	TD	Tšaad	ZA	Lõuna-Aafrika Vabariik
PG	Paapua Uus-Guinea	TG	Togo	ZM	Sambia
PH	Filipiinid	TH	Tai	ZR	Zaire
PK	Pakistan	TJ	Tadžikistan	ZW	Zimbabwe
PL	Poola	TM	Türkmenistan		

**Märkus:** YU - Jugoslaavia **asendatud**  
CS - Serbia ja Montenegro