



EESTI VABARIIK

**T** **EESTI**  
**TÖÖSTUSDISAINI-**  
**LAHENDUSE LEHT**



PATENDIAMETI AMETLIK VÄLJAANNE

**4**  
**2005**  
TALLINN

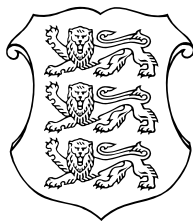

ISSN 1406-376X

EESTI VABARIIK

# T EESTI TÖÖSTUSDISAINI- LAHENDUSE LEHT

**PATENDIAMETI  
AMETLIK VÄLJAANNE**

**VIII aastakäik**

**Käesolevas numbris  
esitatud andmed  
loetakse avaldatuks  
15. novembril 2005. a.**

**4  
2005  
NOVEMBER  
TALLINN**

Eesti Tööstusdisainilahenduse Lehte antakse välja tööstusdisaini kaitse seaduse (jõustunud 11.01.1998) alusel.  
The Estonian Industrial Design Gazette is the official publication of the Estonian Patent Office.  
Published under Industrial Design Protection Law of the Republic of Estonia (coming into force 11 January 1998).  
Date of publication of the data presented in this issue - 15 November 2005.

Patendiameti  
infoosakond  
Toompuiestee 7  
15041 Tallinn  
Tel 627 7907  
Faks 627 7943  
E-post Info@epa.ee

The Information Department  
of the Estonian Patent Office  
Toompuiestee 7  
15041 Tallinn, ESTONIA  
Phone +372 627 7907  
Fax +372 627 7943  
E-mail Info@epa.ee

Levitaja

Eesti Patendiraamatukogu  
Olevimägi 8/10  
10123 Tallinn  
Tel 641 1248  
Faks 641 1018  
E-post patent@patentlib.ee

Distributor

Estonian Patent Library  
Olevimägi 8/10  
10123 Tallinn, ESTONIA  
Phone +372 641 1248  
Fax +372 641 1018  
E-mail patent@patentlib.ee

## SISUKORD

Andmete identifitseerimise rahvusvahelised numberkoodid (INID-koodid) . . . . .	4
Riikide, teiste ühenduste ja valitsustevaheliste organisatsioonide koodid . . . . .	5
I. REGISTREERITUD TÖÖSTUSDISAINILAHENDUSED . . . . .	6
II. RAHVUSVAHELISELT REGISTREERITUD TÖÖSTUSDISAINILAHENDUSED . . . . .	15
III. REGISTREERINGU KEHTIVUSE PIKENDAMINE . . . . .	105
IV. TÖÖSTUSDISAINILAHENDUSE ÜLEMINEK . . . . .	-
V. REGISTREERINGU JAGAMINE . . . . .	-
VI. MUUD REGISTREERINGU ANDMETE MUUDATUSED . . . . .	105
VII. REGISTREERINGU ANDMETE PARANDUSED . . . . .	-
VIII. TÖÖSTUSDISAINILAHENDUSE LITSENTSIDE REGISTREERIMINE . . . . .	-
IX. TÖÖSTUSDISAINILAHENDUSE PANTIDE REGISTREERIMINE . . . . .	-
X. TUNNISTUSE DUPLIKAADI VÄLJAANDMINE . . . . .	-
XI. TÖÖSTUSDISAINILAHENDUSE KUSTUTAMINE REGISTRIST . . . . .	105
XII. LOENDID . . . . .	106
Registreeritud tööstusdisainilahenduste süstemaatiline loend . . . . .	106
Registreeritud tööstusdisainilahenduste registreerimistaotluste numbriline loend . . . . .	106
Avaldatud rahvusvahelise registreeringu registreerimise otsuse teadete numbriline loend . . . . .	106
XIII. TÖÖSTUSDISAINIALASED ÕIGUSAKTID JA MUU INFO . . . . .	107
Riiklikus patendivolinike registris registreeritud patendivolinike nimekiri . . . . .	107

## CONTENTS

Internationally Agreed Numbers for the Identification of Data (INID Codes) . . . . .	4
List of Codes of States, Other Entities and Intergovernmental Organizations . . . . .	5
I. REGISTERED INDUSTRIAL DESIGNS . . . . .	6
II. INTERNATIONALLY REGISTERED INDUSTRIAL DESIGNS . . . . .	15
III. EXTENSION OF THE REGISTRATION . . . . .	105
IV. TRANSFER OF INDUSTRIAL DESIGN . . . . .	-
V. DIVISION OF THE REGISTRATION. . . . .	-
VI. OTHER AMENDMENTS TO REGISTRATION DATA . . . . .	105
VII. CORRECTIONS TO REGISTRATION DATA . . . . .	-
VIII. REGISTERING OF LICENSES OF INDUSTRIAL DESIGN . . . . .	-
IX. REGISTERING OF PLEDGES OF INDUSTRIAL DESIGN . . . . .	-
X. ISSUE OF A COPY OF THE INDUSTRIAL DESIGN CERTIFICATE . . . . .	-
XI. DELETION OF INDUSTRIAL DESIGN FROM THE REGISTER . . . . .	105
XII. LISTS . . . . .	106
Systematic List of Registered Industrial Designs . . . . .	106
Numerical List of Registration Applications of Registered Industrial Designs . . . . .	106
Numerical List of Published Notices of Decisions on Registration of the International Registration . . . . .	106
XIII. LEGAL ACTS AND INFORMATION CONCERNING INDUSTRIAL DESIGNS . . . . .	107
List of Patent Attorneys, Registered in the Estonian State Register of Patent Attorneys . . . . .	111

**ANDMETE IDENTIFITSEERIMISE  
RAHVUSVAHELISED NUMBERKOODID  
(INID-KOODID)  
WIPO Standard ST. 80**

**INTERNATIONALLY AGREED NUMBERS FOR  
THE IDENTIFICATION OF DATA  
(INID CODES)  
WIPO Standard ST. 80**

(11) Registreeringu number	(11) Number of the Registration
(15) Registreerimise kuupäev	(15) Date of the Registration
(18) Registreeringu kehtivuse lõppemise kuupäev	(18) Expected expiration date of the registration
(21) Registreerimistaotluse number	(21) Application Number
(22) Registreerimistaotluse esitamise kuupäev	(22) Application Filing Date
(24) Registreeringu kehtivuse alguse kuupäev	(24) Date from which the Industrial Design right has effected
(28) Variantide arv	(28) Number of Industrial Designs included in the application
(30) Prioriteet	(30) Priority
(51) Rahvusvahelise klassifikatsiooni klassi ja alaklassi number	(51) International Classification for Industrial Designs (class and subclass of the Locarno Classification)
(54) Tööstusdisainilahenduse nimetus	(54) Title of the Industrial Design
(55) Tööstusdisainilahenduse reproduktsioon	(55) Reproduction of the Industrial Design
(72) Tööstusdisainilahenduse autor(id)	(72) Author(s) of Industrial Design
(73) Tööstusdisainilahenduse omanik(ud)	(73) Proprietor(s) of Industrial Design
(74) Patendivolinik või ühine esindaja	(74) Patent Attorney or Common Representative

**RIIKIDE, TEISTE ÜHENDUSTE JA VALITSUSTEVAAHELISTE  
ORGANISATSIOONIDE KOODID**

AD	Andorra	DO	Dominikaani	IT	Itaalia	PT	Portugal
AE	Araabia		Vabariik	JM	Jamaica	PW	Belau
	Ühendemiraadid	DZ	Alžeeria	JO	Jordania	PY	Paraguay
AF	Afganistan	EA	Euraasia	JP	Jaapan	QA	Katar
AG	Antigua ja Barbuda		Patendiorganisat-	KE	Kenya	RO	Rumeenia
AI	Anguilla		sioon (EAPO)	KG	Kõrgõzstan	RU	Venemaa
AL	Albaania	EC	Ecuador	KH	Kambodža	RW	Rwanda
AM	Armeenia	EE	Eesti	KI	Kiribati	SA	Saudi Araabia
AN	Hollandi Antillid	EG	Egiptus	KM	Komoorid	SB	Salomoni Saared
AO	Angola	EH	Lääne-Sahara	KN	Saint Kitts ja Nevis	SC	Seišellid
AP	Aafrika Regionaalne	EM	Siseturu	KP	Põhja-Korea	SD	Sudaan
	Tööstusomandi Orga-		Ühtlustamise	KR	Lõuna-Korea	SE	Rootsi
	nisatsioon (ARIPO)		Amet (kaubamärgid	KW	Kuveit	SG	Singapur
AR	Argentina		ja tööstusdisaini-	KY	Kaimanisaared	SH	Saint Helena
AS	Ameerika Samoa		lahendused)(OHIM)	KZ	Kasahstan	SI	Sloveenia
AT	Austria	EP	Euroopa	LA	Laos	SK	Slovakkia
AU	Austraalia		Patendiamet (EPO)	LB	Liibanon	SL	Sierra Leone
AW	Aruba	ER	Eritrea	LC	Saint Lucia	SM	San Marino
AZ	Aserbaidžaan	ES	Hispaania	LI	Liechtenstein	SN	Senegal
BA	Bosnia ja	ET	Etiopia	LK	Sri Lanka	SO	Somaalia
	Hertsegoviina	FI	Soome	LR	Libeeria	SR	Suriname
BB	Barbados	FJ	Fidži	LS	Lesotho	ST	São Tomé ja Príncipe
BD	Bangladesh	FK	Falklandi (Malviini)	LT	Leedu	SV	El Salvador
BE	Belgia		saared	LU	Luksemburg	SY	Süüria
BF	Burkina Faso	FM	Mikroneesia	LV	Läti	SZ	Svaasimaa
BG	Bulgaaria	FO	Fääri saared	LY	Liibüa	TC	Turks ja Caicos
BH	Bahrein	FR	Prantsusmaa	MA	Maroko	TD	Tšaad
BI	Burundi	GA	Gabon	MC	Monaco	TG	Togo
BJ	Benin	GB	Ühendkuningriik	MD	Moldova	TH	Tai
BM	Bermuda		(Suurbritannia)	MG	Madagaskar	TJ	Tadžikistan
BN	Brunei	GC	Pärsia Lahe	MH	Marshalli Saared	TM	Türkmenistan
BO	Boliivia		Koostöönõukogu	MK	Makedoonia	TN	Tuneesia
BR	Brasiilia	GD	Grenada	ML	Mali	TO	Tonga
BS	Bahama	GE	Gruusia	MM	Myanmar (Birma)	TL	Ida-Timor
BT	Bhutan	GH	Ghana	MN	Mongoolia	TR	Türgi
BV	Bouvet' saar	GI	Gibraltar	MO	Macao	TT	Trinidad ja Tobago
BW	Botswana	GL	Gröönimaa	MP	Põhja-Mariaanid	TV	Tuvalu
BX	Beneluxi	GM	Gambia	MR	Mauritaania	TW	Taiwan (Hiina provints)
	Kaubamärgiamet	GN	Guinea	MS	Montserrat	TZ	Tansaania
	(BBM) ja Beneluxi	GQ	Ekvatoriaal-Guinea	MT	Malta	UA	Ukraina
	Tööstusdisainilahen-	GR	Kreeka	MU	Mauritius	UG	Uganda
	duste Amet (BBDM)	GS	Lõuna-Georgia ja	MV	Maldiivid	US	Ameerika
BY	Valgevene		Lõuna-Sandwichi	MW	Malawi		Ühendriigid
BZ	Belize		saared	MX	Mehhiko	UY	Uruguay
CA	Kanada	GT	Guatemala	MY	Malaisia	UZ	Usbekistan
CF	Kesk-Aafrika	GW	Guinea-Bissau	MZ	Mosambiik	VA	Vatikan (Püha Tool)
	Vabariik	GY	Guyana	NA	Namiibia	VC	Saint Vincent ja
CG	Kongo	HK	Hongkong	NE	Niger		Grenadiinid
CH	Šveits	HN	Honduras	NG	Nigeeria	VE	Venezuela
CI	Côte d'Ivoire	HR	Horvaatia	NI	Nicaragua	VG	Neitsisaared
CK	Cooki saared	HT	Haiti	NL	Holland	VN	Vietnam
CL	Tšiili	HU	Ungari	NO	Norra	VU	Vanuatu
CM	Kamerun	IB	Ülemaailmse	NP	Nepal	WO	Ülemaailmne
CN	Hiina		Intellektuaalomandi	NR	Nauru		Intellektuaalomandi
CO	Kolumbia		Organisatsiooni	NZ	Uus-Meremaa		Organisatsioon
CR	Costa Rica		(WIPO) Rahvus-	OA	Aafrika Intellektuaal-		(WIPO) (Rahvus-
CS	Serbia ja Montenegro		vaheline Büroo		omandi Organisat-		vaheline Büroo)
CU	Kuuba	ID	Indoneesia		sioon (OAPI)	WS	Samoa
CV	Cabo Verde	IE	Iiri	OM	Omaan	YE	Jeemen
CY	Küpros	IL	Iisrael	PA	Panama	ZA	Lõuna-Aafrika Vabariik
CZ	Tšehhi	IM	Man'i saar	PE	Peruu	ZM	Sambia
DE	Saksamaa	IN	India	PG	Paapua Uus-Guinea	ZR	Zaire
DJ	Djibouti	IQ	Iraak	PH	Filipiinid	ZW	Zimbabwe
DK	Taani	IR	Iraan	PK	Pakistan		
DM	Dominica	IS	Island	PL	Poola		

## **I. REGISTREERITUD TÖÖSTUSDISAINILAHENDUSED**

Avaldatakse "Tööstusdisaini kaitse seaduse" § 55<sup>1</sup> lõike 7 alusel.

Patendiamet ei ole kontrollinud tööstusdisainilahenduse uudsust ja eristatavust tulenevalt "Tööstusdisaini kaitse seaduse" § 31 lõike 2 punktist 1.

- (11) **Registreeringu number** **01114** (51) Klass: **23-02, 24-01**
- (21) **Taotluse number** D200500050
- (15) **Registreerimise päev** 15.11.2005
- (22) **Esitamise päev** 06.05.2005
- (24) **Registreeringu kehtivuse alguse päev** 06.05.2005
- (18) **Registreeringu kehtivuse lõppemise päev** 06.05.2010
- (28) **Variantide arv** 1
- (30) **Prioriteediandmed** 29/216,756, 08.11.2004, US
- (72) **Autor** Steven J. Daffer, 6604 Sally Lane, Edina, Minnesota 55439, US  
James M. Garrison, 3048 Hampshire Avenue South, St. Louis Park, Minnesota 55426, US  
Tarmo Kõss, Tammiku tee 23-24, Jüri, 75301 Harju maakond, EE  
Lars Sumberg, Rävåla pst 15-2, 10143 Tallinn, EE  
Tarvo Aulik, Aru küla, Leisi vald, 93823 Saare maakond, EE  
Toomas Kelder, Hüüru, 76902 Harju maakond, EE
- (73) **Omanik** Visibelle Derma Institute, Inc., 9220 James Avenue South, Bloomington, Minnesota 55431, US  
Wellspa OÜ, Varbola, Märjamaa vald, 78203 Rapla maakond, EE
- (74) **Patendivolinik või ühine esindaja** Kaie Puur

(54) **Nimetus** **Tervisekapsel**

(55) **Reproduktsoon**

01114-01

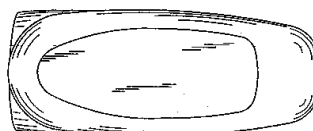
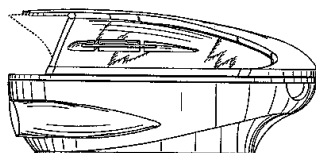
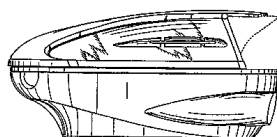
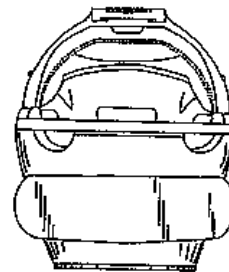
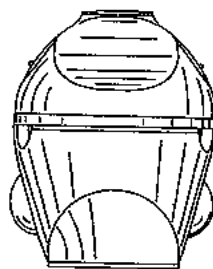
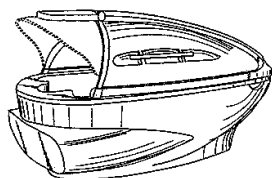



(11) Registreeringu number	<b>01115</b>	(51) Klass: <b>14-03</b>
(21) Taotluse number	D200500054	
(15) Registreerimise päev	15.11.2005	
(22) Esitamise päev	08.07.2005	
(24) Registreeringu kehtivuse alguse päev	08.07.2005	
(18) Registreeringu kehtivuse lõppemise päev	08.07.2010	
(28) Variantide arv	1	
(30) Prioriteediandmed	29/220,975, 10.01.2005, US	
(72) Autor	Pekka Majanen, Jahtikatu 17, 24280 Salo, FI Todd Wood, 1544 12th Street #202, Santa Monica, CA 90401, US	
(73) Omanik	Nokia Corporation, Keilalahdentie 4, FIN-02150 Espoo, FI	
(74) Patendivolinik või ühine esindaja	Kalev Käosaar	

(54) Nimetus **Käsitelefon**

(55) Reproduktioon

01115-01

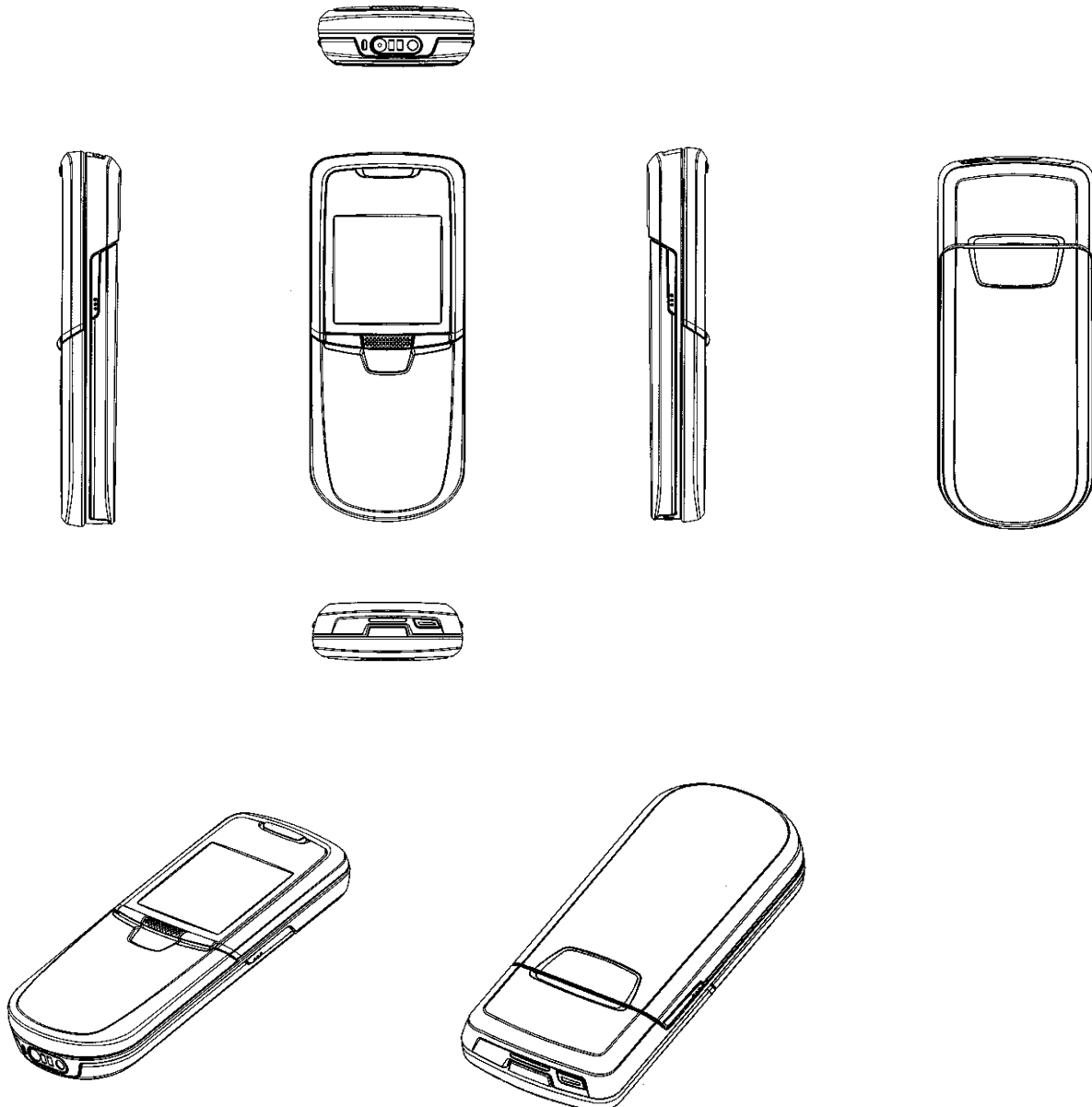

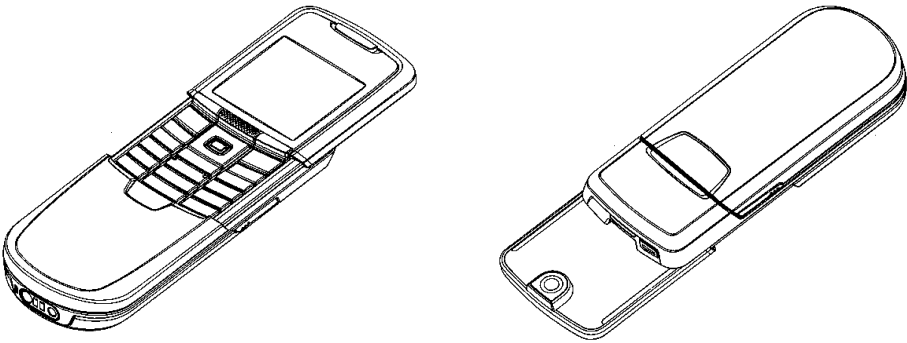
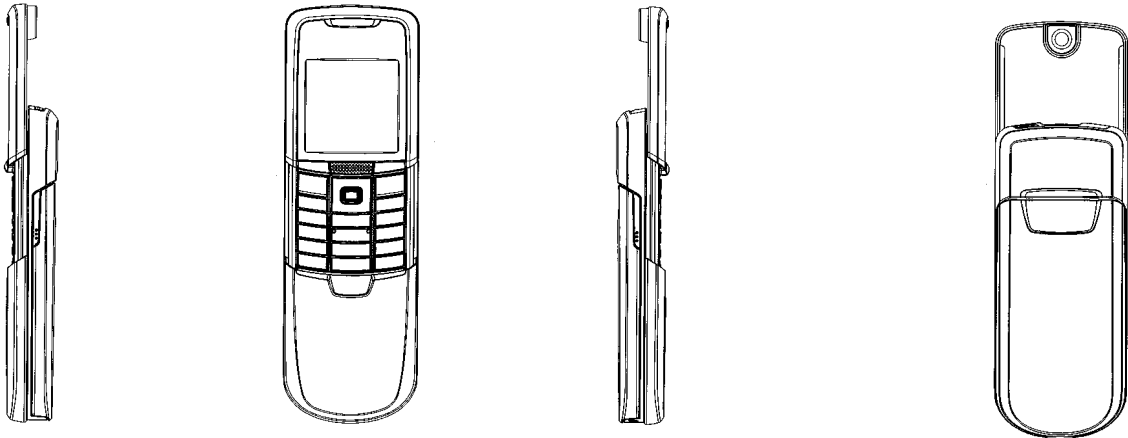

(11) Registreeringu number	<b>01116</b>	(51) Klass: <b>13-02</b>
(21) Taotluse number	D200500059	
(15) Registreerimise päev	15.11.2005	
(22) Esitamise päev	10.08.2005	
(24) Registreeringu kehtivuse alguse päev	10.08.2005	
(18) Registreeringu kehtivuse lõppemise päev	10.08.2010	
(28) Variantide arv	1	
(30) Prioriteediandmed	M20050022, 11.02.2005, FI	
(72) Autor	Heli Säde, Liitoskatu 11, 24260 Salo, FI Janne Loiske, Välppätie 5 b as 40, 20540 Turku, FI	
(73) Omanik	Nokia Corporation, Keilalahdentie 4, FIN-02150 Espoo, FI	
(74) Patendivolinik või ühine esindaja	Kalev Käosaar	

(54) Nimetus **Laadija**

(55) Reproduktsoon

01116-01

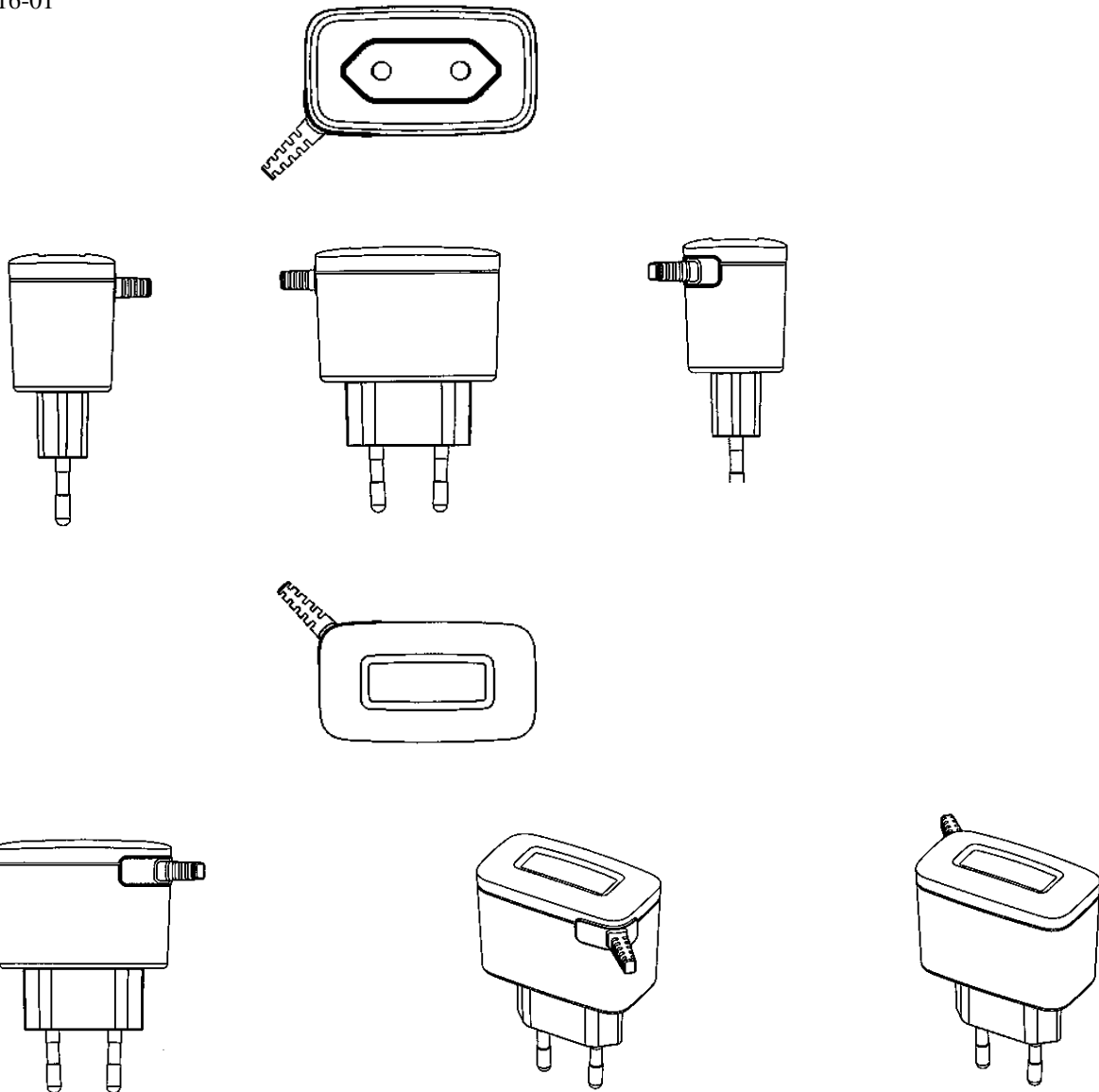

(11) **Registreeringu number** **01117**

(51) Klass: **02-05, 05-05**

(21) **Taotluse number** D200500060

(15) **Registreerimise päev** 15.11.2005

(22) **Esitamise päev** 12.08.2005

(24) **Registreeringu kehtivuse alguse päev** 12.08.2005

(18) **Registreeringu kehtivuse lõppemise päev** 12.08.2010

(28) **Variantide arv** 6

(72) **Autor** Svetlana Sidorenko, Kolde pst 98-93, 10316 Tallinn, EE

(73) **Omanik** Svetlana Sidorenko, Kolde pst 98-93, 10316 Tallinn, EE

(74) **Patendivolinik või ühine esindaja** Lembit Kalev

(54) **Nimetus** **Kudum**

(55) **Reproduktsoon**

01117-01

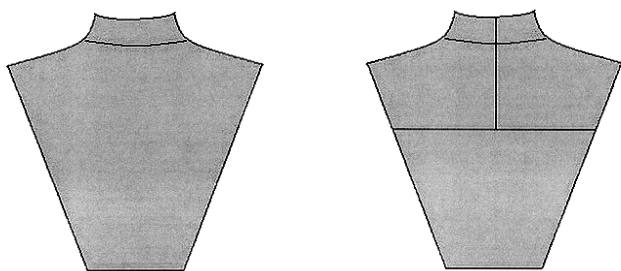

01117-02

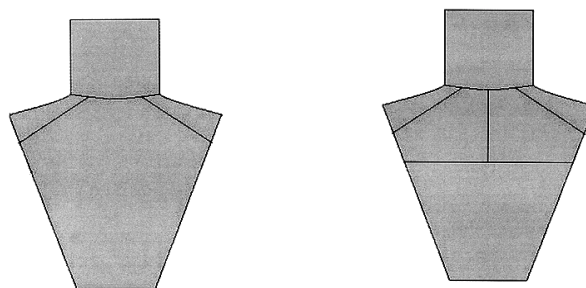

01117-03

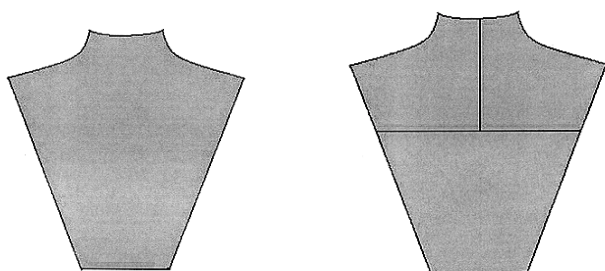

01117-04

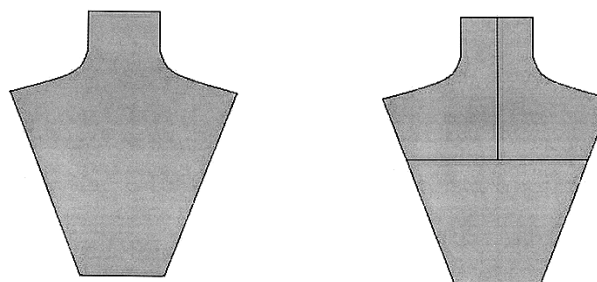

01117-05

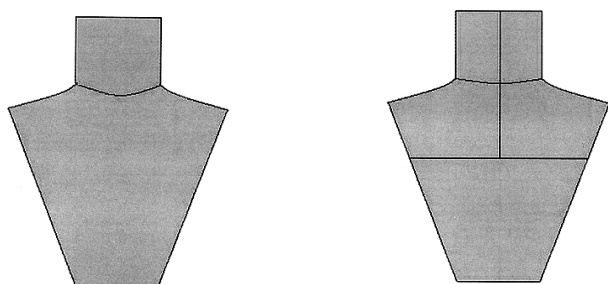

01117-06

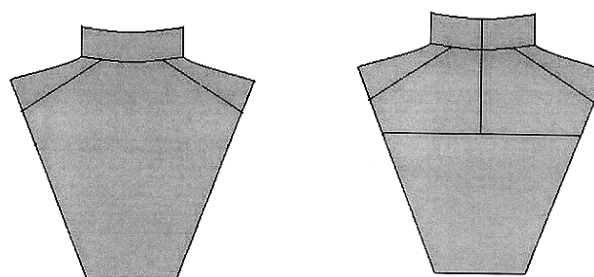

(11) Registreeringu number	01118	(51) Klass: 13-02, 14-01, 14-03
(21) Taotluse number	D200500061	
(15) Registreerimise päev	15.11.2005	
(22) Esitamise päev	25.08.2005	
(24) Registreeringu kehtivuse alguse päev	25.08.2005	
(18) Registreeringu kehtivuse lõppemise päev	25.08.2010	
(28) Variantide arv	1	
(30) Prioriteediandmed	M20050032, 28.02.2005, FI	
(72) Autor	Jan Kettula, Leppanvaarankatu 17 E 30, 02600 Espoo, FI Sami Lehtovaara, Suovasentie 52, 21250 Masku, FI	
(73) Omanik	Nokia Corporation, Keilalahdentie 4, FIN-02150 Espoo, FI	
(74) Patendivolinik või ühine esindaja	Kalev Käosaar	

(54) Nimetus **Käsitelefoni "Käed vabad" seade/laadija**

(55) Reproduktsoon

01118-01

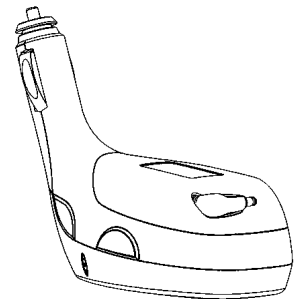
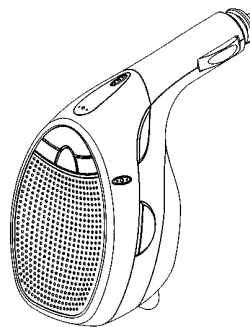
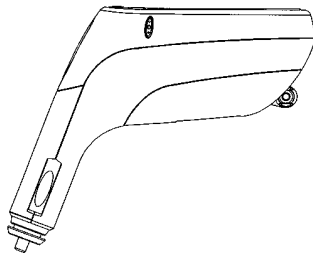
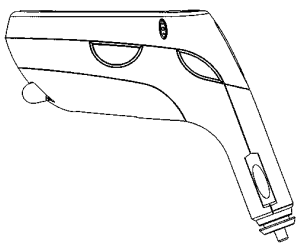
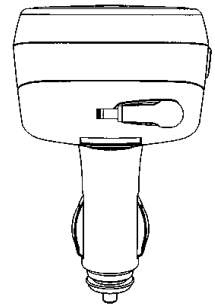
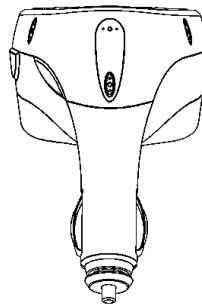
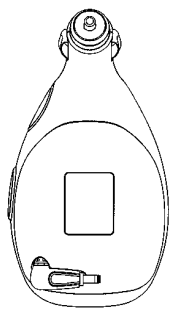
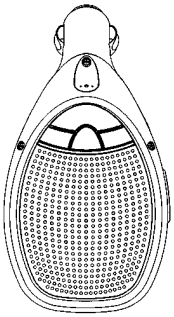

- (11) **Registreeringu number** **01119** (51) Klass: **14-03**
- (21) **Taotluse number** D200500064
- (15) **Registreerimise päev** 15.11.2005
- (22) **Esitamise päev** 15.09.2005
- (24) **Registreeringu kehtivuse alguse päev** 15.09.2005
- (18) **Registreeringu kehtivuse lõppemise päev** 15.09.2010
- (28) **Variantide arv** 1
- (30) **Prioriteediandmed** M20050046, 16.03.2005, FI
- (72) **Autor** Ingve Holmung, 68 Ormonde Court, Upper Richmond Road, London SW 15 6TP, GB  
Anthony Dalby, 30, Chandos Avenue, Ealing, London W5 4ER, GB
- (73) **Omanik** Nokia Corporation, Keilalahdentie 4, FIN-02150 Espoo, FI
- (74) **Patendivolinik või ühine esindaja** Kaie Puur

(54) **Nimetus** **Käsitelefon**

(55) **Reproduktsoon**

01119-01

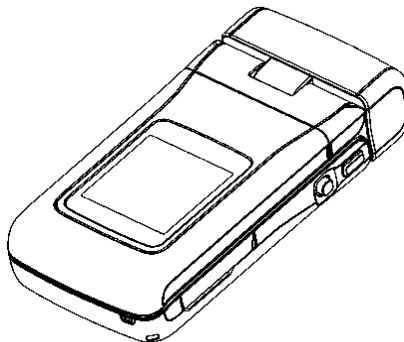
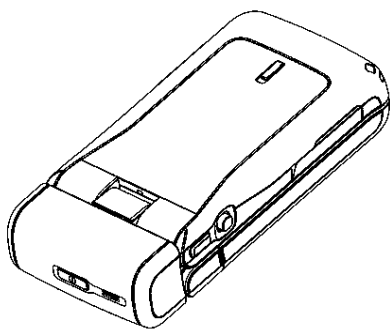
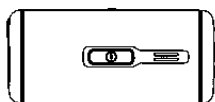
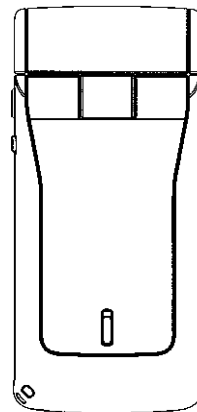
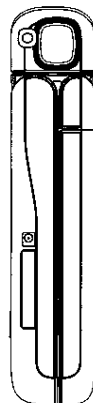
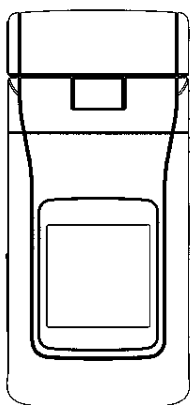
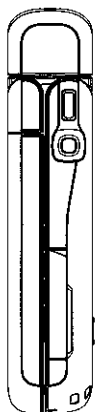
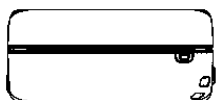

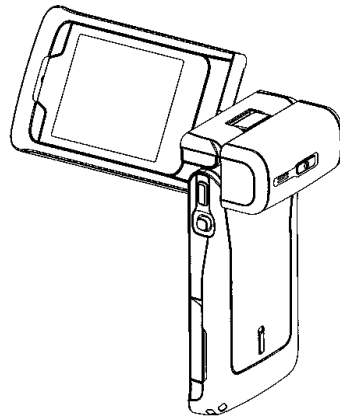
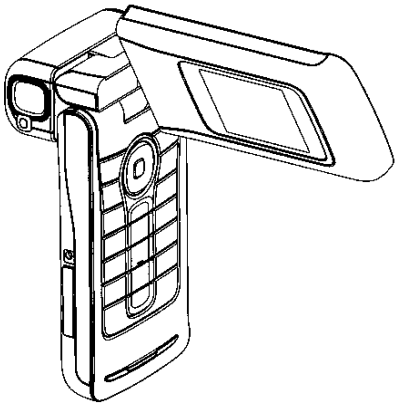
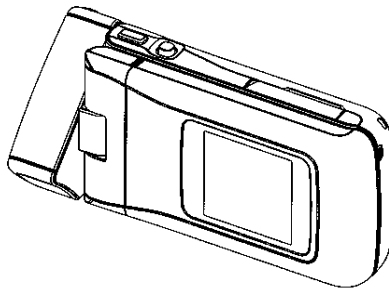
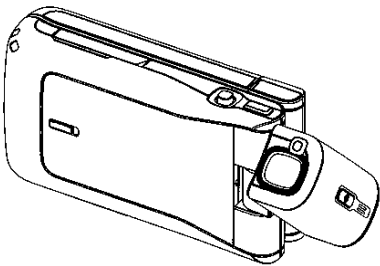
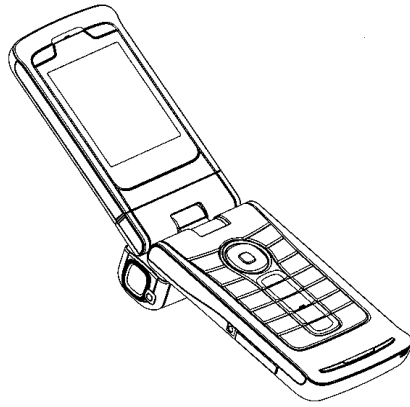
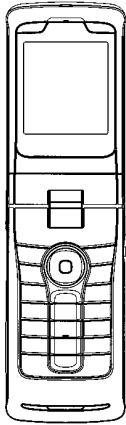

## **II. RAHVUSVAHELISELT REGISTREERITUD TÖÖSTUSDISAINILAHENDUSED**

Avaldatakse "Tööstusdisaini kaitse seaduse" § 87<sup>4</sup> lõike37 alusel.



- (11) **Rahvusvah reg nr** DM/065295 (51) Klass: **10-07**
- (21) **Rahvusvah reg jrk** H200400002
- (15) **Registreeringu päev** 06.04.2004
- (22) **Esitamise päev** 06.04.2004
- (28) **Variantide arv** 1
- (72) **Autor** Walter GARRO, SWATCHLAB, Via Archimede 6, IT-20129 MILANO, IT  
Nicole DUPONT, Dupont Design, Chemin des Raclerets 26, 1284 Chancy, CH
- (73) **Omanik** SWATCH AG (SWATCH SA) (SWATCHLTD.), 94, Rue Jakob Stämpfli, CH-2502 BIENNE, CH
- WIPO Rahvusvah Tööstusdisainilahenduste Bülletääni nr, kus registreering on avaldatud** 2004/07

(54) **Nimetus** Watch strap

(55) **Reproduktsoon**

DM/065295-01



(11) <b>Rahvusvah reg nr</b>	<b>DM/065296</b>	(51) Klass: <b>10-02</b>
(21) <b>Rahvusvah reg jrk</b>	H200400003	
(15) <b>Registreeringu päev</b>	02.04.2004	
(22) <b>Esitamise päev</b>	02.04.2004	
(28) <b>Variantide arv</b>	1	
(72) <b>Autor</b>	Vincent LAUCELLA, Route de France 38, 1348 Le Brassus, CH	
(73) <b>Omanik</b>	MONTRES BREGUET S.A., CH-1344 L'ABBAYE, CH	
<b>WIPO Rahvusvah Tööstusdisainilahenduste</b>		
<b>Bülletääni nr, kus registreering on avaldatud</b>	2004/07	

(54) **Nimetus** Watch

(55) **Reproduktsoon**

DM/065296-01

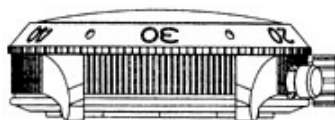
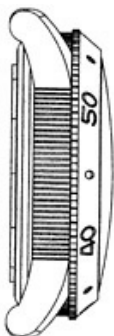
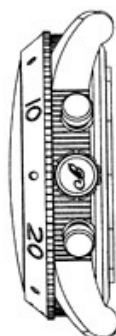

(11) <b>Rahvusvah reg nr</b>	<b>DM/065301</b>	(51) Klass: <b>10-02</b>
(21) <b>Rahvusvah reg jrk</b>	H200400006	
(15) <b>Registreeringu päev</b>	06.04.2004	
(22) <b>Esitamise päev</b>	06.04.2004	
(28) <b>Variantide arv</b>	1	
(72) <b>Autor</b>	Rossana BOFFI, Swatchlab, Via Archimede 6, 20129 Milano, IT Adelina BISSOLO, SWATCHLAB, Via Archimede 6, 20129 MILANO, IT Walter GARRO, SWATCHLAB, Via Archimede 6, IT-20129 MILANO, IT Nicole DUPONT, Dupont Design, Chemin des Raclerets 26, 1284 Chancy, CH	
(73) <b>Omanik</b>	SWATCH AG (SWATCH SA) (SWATCH LTD.), 94, Rue Jakob Stämpfli, CH-2502 BIENNE, CH	
<b>WIPO Rahvusvah Tööstusdisainilahenduste Bülletääni nr, kus registreering on avaldatud</b>	2004/07	

(54) **Nimetus** **Wristwatch**

(55) **Reproduksioon**

DM/065301-01



(11) <b>Rahvusvah reg nr</b>	<b>DM/065355</b>	(51) Klass: <b>10-02</b>
(21) <b>Rahvusvah reg jrk</b>	H200400011	
(15) <b>Registreeringu päev</b>	06.04.2004	
(22) <b>Esitamise päev</b>	06.04.2004	
(28) <b>Variantide arv</b>	1	
(72) <b>Autor</b>	Nicz RIPZ, A New Day GmbH, Laurenz-Sond. Str. 3b, CH-9436 Balgach, CH	
(73) <b>Omanik</b>	SWATCH AG (SWATCH SA) (SWATCH LTD.), 94, Rue Jakob Stämpfli, CH-2502 BIENNE, CH	

**WIPO Rahvusvah Tööstusdisainilahenduste  
Bülletääni nr, kus registreering on avaldatud** 2004/07

(54) **Nimetus** **Wristwatch**

(55) **Reproduktsoon**

DM/065355-01



(11) <b>Rahvusvah reg nr</b>	<b>DM/065361</b>	(51) Klass: <b>10-02</b>
(21) <b>Rahvusvah reg jrk</b>	H200400013	
(15) <b>Registreeringu päev</b>	12.05.2004	
(22) <b>Esitamise päev</b>	12.05.2004	
(28) <b>Variantide arv</b>	1	
(72) <b>Autor</b>	Adelina BISSOLO, SWATCHLAB, Via Archimede 6, 20129 MILANO, IT	
(73) <b>Omanik</b>	SWATCH AG (SWATCH SA) (SWATCH LTD.), 94, Rue Jakob Stämpfli, CH-2502 BIENNE, CH	
<b>WIPO Rahvusvah Tööstusdisainilahenduste Bülletääni nr, kus registreering on avaldatud</b>	2004/07	

(54) **Nimetus** **Wristwatch**

(55) **Reproduktsoon**

DM/065361-01



- (11) **Rahvusvah reg nr** **DM/065364** (51) Klass: **10-02**
- (21) **Rahvusvah reg jrk** H200400015
- (15) **Registreeringu päev** 05.05.2004
- (22) **Esitamise päev** 05.05.2004
- (28) **Variantide arv** 1
- (72) **Autor** Katia DE CONTI, Dupont Design SA, Rte des Jeunes 33,  
CH-1227 CAROUGE, CH  
Adelina BISSOLO, SWATCHLAB, Via Archimede 6, 20129 MILANO,  
IT
- (73) **Omanik** SWATCH AG (SWATCH SA) (SWATCHLTD.), 94, Rue Jakob Stämpfli,  
CH-2502 BIENNE, CH
- WIPO Rahvusvah Tööstusdisainilahenduste**  
**Bülletääni nr, kus registreering on avaldatud** 2004/07
- (54) **Nimetus** **Wristwatch**
- (55) **Reproduktsoon**
- DM/065364-01



(11) <b>Rahvusvah reg nr</b>	<b>DM/065365</b>	(51) Klass: <b>10-02</b>
(21) <b>Rahvusvah reg jrk</b>	H200400016	
(15) <b>Registreeringu päev</b>	12.05.2004	
(22) <b>Esitamise päev</b>	12.05.2004	
(28) <b>Variantide arv</b>	1	
(72) <b>Autor</b>	Nicole Dupont, Dupont Design SA, Rte des Jeunes 33, CH-1227 CAROUGE, CH	
(73) <b>Omanik</b>	SWATCH AG (SWATCH SA) (SWATCH LTD.), 94, Rue Jakob Stämpfli, CH-2502 BIENNE, CH	

**WIPO Rahvusvah Tööstusdisainilahenduste  
Bülletääni nr, kus registreering on avaldatud** 2004/07

(54) **Nimetus** **Wristwatch**

(55) **Reproduktsoon**

DM/065365-01



(11) <b>Rahvusvah reg nr</b>	<b>DM/065367</b>	(51) Klass: <b>10-02</b>
(21) <b>Rahvusvah reg jrk</b>	H200400018	
(15) <b>Registreeringu päev</b>	06.04.2004	
(22) <b>Esitamise päev</b>	06.04.2004	
(28) <b>Variantide arv</b>	1	
(72) <b>Autor</b>	Malcolm DRAGOTTA, SWATCHLAB, Via Archimede 6, IT-20129 Milano, IT	
(73) <b>Omanik</b>	SWATCH AG (SWATCH SA) (SWATCH LTD.), 94, Rue Jakob Stämpfli, CH-2502 BIENNE, CH	
<b>WIPO Rahvusvah Tööstusdisainilahenduste Bülletääni nr, kus registreering on avaldatud</b>	2004/07	

(54) **Nimetus** **Wristwatch**

(55) **Reproduktsoon**

DM/065367-01





(11) **Rahvusvah reg nr****DM/065388**(51) Klass: **10-07**(21) **Rahvusvah reg jrk**

H200400024

(15) **Registreeringu päev**

06.04.2004

(22) **Esitamise päev**

06.04.2004

(28) **Variantide arv**

1

(72) **Autor**Manuel EMCH, Montres Jaquet-Droz SA, Rue Jaquet-Droz 5,  
CH-2300 LA CHAUX-DE-FONDS, CH(73) **Omanik**MONTRES JAQUET-DROZ SA,  
Faubourg de l'Hôpital 3 c/o Caisse de Pensions Swatch Group,  
NEUCHÂTEL, CH**WIPO Rahvusvah Tööstusdisainilahenduste****Bülletääni nr, kus registreering on avaldatud** 2004/07(54) **Nimetus****Middle**(55) **Reproduksioon**

DM/065388-01

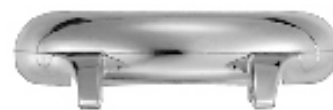

(11) <b>Rahvusvah reg nr</b>	<b>DM/065395</b>	(51) <b>Klass: 10-02</b>
(21) <b>Rahvusvah reg jrk</b>	H200400028	
(15) <b>Registreeringu päev</b>	18.05.2004	
(22) <b>Esitamise päev</b>	18.05.2004	
(28) <b>Variantide arv</b>	1	
(72) <b>Autor</b>	Nicole Dupont, Dupont Design SA, Rte des Jeunes 33, CH-1227 CAROUGE, CH	
(73) <b>Omanik</b>	SWATCH AG (SWATCH SA) (SWATCH LTD.), 94, Rue Jakob Stämpfli, CH-2502 BIENNE, CH	
<b>WIPO Rahvusvah Tööstusdisainilahenduste Bülletääni nr, kus registreering on avaldatud</b>	2004/07	

(54) **Nimetus** **Wristwatch**

(55) **Reproduksioon**

DM/065395-01



(11) **Rahvusvah reg nr**

**DM/065463**

(51) Klass: **10-02**

(21) **Rahvusvah reg jrk**

H200400030

(15) **Registreeringu päev**

09.06.2004

(22) **Esitamise päev**

09.06.2004

(28) **Variantide arv**

3

(72) **Autor**

*Autori andmeid ei avalikustata*

(73) **Omanik**

LÉON HATOT SA (LÉON HATOT AG) (LÉON HATOT LTD.),  
Fauborg de l'Hôpital 3, CH-2000 Neuchâtel, CH

**WIPO Rahvusvah Tööstusdisainilahenduste  
Bülletääni nr, kus registreering on avaldatud**

2004/07

(54) **Nimetus**

**Wristwatches**

(55) **Reproduktsoon**

DM/065463-01



DM/065463-02



DM/065463-03



(11) <b>Rahvusvah reg nr</b>	<b>DM/065470</b>	(51) <b>Klass: 10-02</b>
(21) <b>Rahvusvah reg jrk</b>	H200400034	
(15) <b>Registreeringu päev</b>	17.06.2004	
(22) <b>Esitamise päev</b>	17.06.2004	
(28) <b>Variantide arv</b>	9	
(72) <b>Autor</b>	1, 2, 4, 5, 6 Thibaud Dubayle, Drôle de Tribu, Av.de Choisy 104, F-75013 Paris, FR 3, 9 Alessandra Attanasi, Residenza Archi 221, Milano 2, IT-20090 Segrate, IT 7 Véronique Stoll, CDNP, Schützengasse 30, CH-2540 Grenchen, CH 8 Nicole Dupont, Dupont Design SA, 33, rte des Jeunes, CH-1227 Carouge/Genève, CH ETA SA MANUFACTURE HORLOGERE SUISSE, CH-2540 GRENCHEN, CH	
(73) <b>Omanik</b>		

**WIPO Rahvusvah Tööstusdisainilahenduste  
Bülletääni nr, kus registreering on avaldatud** 2004/07

(54) **Nimetus** **Wristwatches**

(55) **Reproduksioon**

DM/065470-01



DM/065470-02



DM/065470-03



DM/065470-04



DM/065470-05



DM/065470-06



DM/065470-07



DM/065470-08



DM/065470-09



(11) <b>Rahvusvah reg nr</b>	<b>DM/065471</b>	(51) <b>Klass: 10-02</b>
(21) <b>Rahvusvah reg jrk</b>	H200400035	
(15) <b>Registreeringu päev</b>	18.06.2004	
(22) <b>Esitamise päev</b>	18.06.2004	
(28) <b>Variantide arv</b>	1	
(72) <b>Autor</b>	Walter GARRO, SWATCHLAB, Via Archimede, 6, IT-20129 Milano, IT	
(73) <b>Omanik</b>	SWATCH AG (SWATCH SA) (SWATCH LTD.), 94, Rue Jakob Stämpfli, CH-2502 BIENNE, CH	
<b>WIPO Rahvusvah Tööstusdisainilahenduste Bülletääni nr, kus registreering on avaldatud</b>	2004/07	

(54) **Nimetus** **Wristwatch**

(55) **Reproduktsoon**

DM/065471-01





(11) <b>Rahvusvah reg nr</b>	<b>DM/065498</b>	(51) Klass: <b>10-02</b>
(21) <b>Rahvusvah reg jrk</b>	H200400041	
(15) <b>Registreeringu päev</b>	18.06.2004	
(22) <b>Esitamise päev</b>	18.06.2004	
(28) <b>Variantide arv</b>	1	
(72) <b>Autor</b>	Nicole Dupont, Dupont Design SA, Rte des Jeunes 33, CH-1227 CAROUGE, CH	
(73) <b>Omanik</b>	SWATCH AG (SWATCH SA) (SWATCH LTD.), 94, Rue Jakob Stämpfli, CH-2502 BIENNE, CH	
<b>WIPO Rahvusvah Tööstusdisainilahenduste Bülletääni nr, kus registreering on avaldatud</b>	2004/07	

(54) **Nimetus** **Wristwatch**

(55) **Reproduksioon**

DM/065498-01



(11) <b>Rahvusvah reg nr</b>	<b>DM/065500</b>	(51) Klass: <b>10-02</b>
(21) <b>Rahvusvah reg jrk</b>	H200400043	
(15) <b>Registreeringu päev</b>	18.06.2004	
(22) <b>Esitamise päev</b>	18.06.2004	
(28) <b>Variantide arv</b>	1	
(72) <b>Autor</b>	Walter GARRO, SWATCHLAB, Via Archimede 6, IT-20129 MILANO, IT	
(73) <b>Omanik</b>	SWATCH AG (SWATCH SA) (SWATCH LTD.), 94, Rue Jakob Stämpfli, CH-2502 BIENNE, CH	
<b>WIPO Rahvusvah Tööstusdisainilahenduste Bülletääni nr, kus registreering on avaldatud</b>	2004/7	

(54) **Nimetus** **Wristwatch**

(55) **Reproduktsoon**

DM/065500-01



- (11) **Rahvusvah reg nr** DM/065502 (51) Klass: **10-02**
- (21) **Rahvusvah reg jrk** H200400045
- (15) **Registreeringu päev** 18.06.2004
- (22) **Esitamise päev** 18.06.2004
- (28) **Variantide arv** 2
- (72) **Autor** Andrea ARRIGONI, SWATCHLAB, Via Archimede 6,  
CH-20129 MILANO, CH
- (73) **Omanik** SWATCH AG (SWATCH SA) (SWATCH LTD.), 94, Rue Jakob Stämpfli,  
CH-2502 BIENNE, CH

**WIPO Rahvusvah Tööstusdisainilahenduste**  
**Bülletääni nr, kus registreering on avaldatud** 2004/07

(54) **Nimetus** Wristwatches

(55) **Reproduktsoon**

DM/065502-01



DM/065502-02



(11) **Rahvusvah reg nr** DM/065505

(51) Klass: **11-01**

(21) **Rahvusvah reg jrk** H200400048

(15) **Registreeringu päev** 17.06.2004

(22) **Esitamise päev** 17.06.2004

(28) **Komplektide arv** 1

(72) **Autor** Fred LAMBERT, Design Concept, 18, rue du Terrage, F-75010 PARIS, FR

(73) **Omanik** SWATCH AG (SWATCH SA) (SWATCH LTD.), 94, Rue Jakob Stämpfli, CH-2502 BIENNE, CH

**WIPO Rahvusvah Tööstusdisainilahenduste  
Bülletääni nr, kus registreering on avaldatud** 2004/07

(54) **Nimetus** Strap; ring

(55) **Reproduksioon**

DM/065505-01

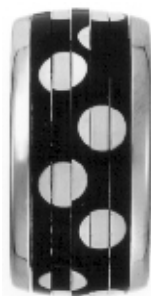
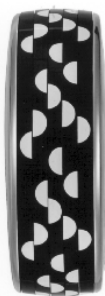

(11) <b>Rahvusvah reg nr</b>	<b>DM/065586</b>	(51) Klass: <b>10-02</b>
(21) <b>Rahvusvah reg jrk</b>	H200400052	
(15) <b>Registreeringu päev</b>	20.07.2004	
(22) <b>Esitamise päev</b>	20.07.2004	
(28) <b>Variantide arv</b>	1	
(72) <b>Autor</b>	Rossana BOFFI, Swatchlab, Via Archimede 6, 20129 Milano, IT	
(73) <b>Omanik</b>	SWATCH AG (SWATCH SA) (SWATCH LTD.), 94, Rue Jakob Stämpfli, CH-2502 BIENNE, CH	
<b>WIPO Rahvusvah Tööstusdisainilahenduste Bülletääni nr, kus registreering on avaldatud</b>	2004/07	

(54) **Nimetus** **Wristwatch**

(55) **Reproduktsoon**

DM/065586-01



- (11) **Rahvusvah reg nr** DM/065592 (51) Klass: **10-07**
- (21) **Rahvusvah reg jrk** H200400058
- (15) **Registreeringu päev** 19.07.2004
- (22) **Esitamise päev** 19.07.2004
- (28) **Variantide arv** 1
- (72) **Autor** Walter GARRO, SWATCHLAB, Via Archimede 6, IT-20129 MILANO, IT
- (73) **Omanik** SWATCH AG (SWATCH SA) (SWATCH LTD.), 94, Rue Jakob Stämpfli, CH-2502 BIENNE, CH
- WIPO Rahvusvah Tööstusdisainilahenduste Bülletääni nr, kus registreering on avaldatud** 2004/07

(54) **Nimetus** Watch bracelet

(55) **Reproduktsoon**

DM/065592-01



(11) <b>Rahvusvah reg nr</b>	<b>DM/065593</b>	(51) Klass: <b>10-07</b>
(21) <b>Rahvusvah reg jrk</b>	H200400059	
(15) <b>Registreeringu päev</b>	20.07.2004	
(22) <b>Esitamise päev</b>	20.07.2004	
(28) <b>Variantide arv</b>	1	
(72) <b>Autor</b>	Nicole DUPONT, Dupont Design SA, Rte des Jeunes 33, CH-1227 Carouge/Genève, CH	
(73) <b>Omanik</b>	SWATCH AG (SWATCH SA) (SWATCH LTD.), 94, Rue Jakob Stämpfli, CH-2502 BIENNE, CH	
<b>WIPO Rahvusvah Tööstusdisainilahenduste Bülletääni nr, kus registreering on avaldatud</b>	2004/07	

(54) **Nimetus** **Watch band**

(55) **Reproduktsoon**

DM/065593-01



(11) <b>Rahvusvah reg nr</b>	<b>DM/065595</b>	(51) Klass: <b>10-02</b>
(21) <b>Rahvusvah reg jrk</b>	H200400061	
(15) <b>Registreeringu päev</b>	19.07.2004	
(22) <b>Esitamise päev</b>	19.07.2004	
(28) <b>Variantide arv</b>	1	
(72) <b>Autor</b>	Fabrizio Cuppini, SWATCHLAB, Via Archimede 6, IT20129 MILANO, IT	
(73) <b>Omanik</b>	SWATCH AG (SWATCH SA) (SWATCH LTD.), 94, Rue Jakob Stämpfli, CH-2502 BIENNE, CH	
<b>WIPO Rahvusvah Tööstusdisainilahenduste Bülletääni nr, kus registreering on avaldatud</b>	2004/07	

(54) **Nimetus** **Wristwatch**

(55) **Reproduktsoon**

DM/065595-01





(11) <b>Rahvusvah reg nr</b>	<b>DM/065596</b>	(51) Klass: <b>10-02</b>
(21) <b>Rahvusvah reg jrk</b>	H200400062	
(15) <b>Registreeringu päev</b>	20.07.2004	
(22) <b>Esitamise päev</b>	20.07.2004	
(28) <b>Variantide arv</b>	1	
(72) <b>Autor</b>	Rossana Boffi, SWATCHLAB, Via Archimede 6, IT-21129 MILANO, IT	
(73) <b>Omanik</b>	SWATCH AG (SWATCH SA) (SWATCH LTD.), 94, Rue Jakob Stämpfli, CH-2502 BIENNE, CH	
<b>WIPO Rahvusvah Tööstusdisainilahenduste Bülletääni nr, kus registreering on avaldatud</b>	2004/07	

(54) **Nimetus** **Wristwatch**

(55) **Reproduktsoon**

DM/065596-01



(11) <b>Rahvusvah reg nr</b>	<b>DM/065597</b>	(51) <b>Klass: 10-02</b>
(21) <b>Rahvusvah reg jrk</b>	H200400063	
(15) <b>Registreeringu päev</b>	20.07.2004	
(22) <b>Esitamise päev</b>	20.07.2004	
(28) <b>Variantide arv</b>	1	
(72) <b>Autor</b>	Nicole DUPONT, Dupont Design SA, Rte des Jeunes 33, CH-1227 Carouge/Genève, CH	
(73) <b>Omanik</b>	SWATCH AG (SWATCH SA) (SWATCH LTD.), 94, Rue Jakob Stämpfli, CH-2502 BIENNE, CH	
<b>WIPO Rahvusvah Tööstusdisainilahenduste Bülletääni nr, kus registreering on avaldatud</b>	2004/07	

(54) **Nimetus** **Wristwatch**

(55) **Reproduktsoon**

DM/065597-01



(11) <b>Rahvusvah reg nr</b>	<b>DM/065598</b>	(51) Klass: <b>10-02</b>
(21) <b>Rahvusvah reg jrk</b>	H200400064	
(15) <b>Registreeringu päev</b>	20.07.2004	
(22) <b>Esitamise päev</b>	20.07.2004	
(28) <b>Variantide arv</b>	1	
(72) <b>Autor</b>	Walter GARRO, SWATCHLAB, Via Archimede 6, IT-20129 MILANO, IT	
(73) <b>Omanik</b>	SWATCH AG (SWATCH SA) (SWATCH LTD.), 94, Rue Jakob Stämpfli, CH-2502 BIENNE, CH	
<b>WIPO Rahvusvah Tööstusdisainilahenduste Bülletääni nr, kus registreering on avaldatud</b>	2004/07	

(54) **Nimetus** **Wristwatch**

(55) **Reproduktsoon**

DM/065598-01



(11) <b>Rahvusvah reg nr</b>	<b>DM/065599</b>	(51) Klass: <b>10-02</b>
(21) <b>Rahvusvah reg jrk</b>	H200400065	
(15) <b>Registreeringu päev</b>	19.07.2004	
(22) <b>Esitamise päev</b>	19.07.2004	
(28) <b>Variantide arv</b>	1	
(72) <b>Autor</b>	Nicz RIPZ, A New Day GmbH, Laurenz-Sond. Str. 3b, CH-9436 Balgach, CH	
(73) <b>Omanik</b>	SWATCH AG (SWATCH SA) (SWATCH LTD.), 94, Rue Jakob Stämpfli, CH-2502 BIENNE, CH	
<b>WIPO Rahvusvah Tööstusdisainilahenduste Bülletääni nr, kus registreering on avaldatud</b>	2004/07	

(54) **Nimetus** **Wristwatch**

(55) **Reproduktsoon**

DM/065599-01



(11) <b>Rahvusvah reg nr</b>	<b>DM/065600</b>	(51) Klass: <b>10-02</b>
(21) <b>Rahvusvah reg jrk</b>	H200400066	
(15) <b>Registreeringu päev</b>	20.07.2004	
(22) <b>Esitamise päev</b>	20.07.2004	
(28) <b>Variantide arv</b>	1	
(72) <b>Autor</b>	<i>Autori andmeid ei avalikustata</i>	
(73) <b>Omanik</b>	SWATCH AG (SWATCH SA) (SWATCH LTD.), 94, Rue Jakob Stämpfli, CH-2502 BIENNE, CH	
<b>WIPO Rahvusvah Tööstusdisainilahenduste Bülletääni nr, kus registreering on avaldatud</b>	2004/07	

(54) **Nimetus** **Wristwatch**

(55) **Reproduktsoon**

DM/065600-01



(11) <b>Rahvusvah reg nr</b>	<b>DM/065602</b>	(51) Klass: <b>10-02</b>
(21) <b>Rahvusvah reg jrk</b>	H200400068	
(15) <b>Registreeringu päev</b>	20.07.2004	
(22) <b>Esitamise päev</b>	20.07.2004	
(28) <b>Variantide arv</b>	1	
(72) <b>Autor</b>	Walter GARRO, SWATCHLAB, Via Archimede 6, IT-20129 MILANO, IT	
(73) <b>Omanik</b>	SWATCH AG (SWATCH SA) (SWATCH LTD.), 94, Rue Jakob Stämpfli, CH-2502 BIENNE, CH	
<b>WIPO Rahvusvah Tööstusdisainilahenduste Bülletääni nr, kus registreering on avaldatud</b>	2004/07	

(54) **Nimetus** **Wristwatch**

(55) **Reproduktsoon**

DM/065602-01



(11) **Rahvusvah reg nr****DM/065604**(51) Klass: **11-01**(21) **Rahvusvah reg jrk**

H200400070

(15) **Registreeringu päev**

20.07.2004

(22) **Esitamise päev**

20.07.2004

(28) **Komplektide arv**

1

(72) **Autor**

Nicolas Barth Nussbaumer, St. Honoré 10, CH-2000 Neuchâtel, CH

(73) **Omanik**

SWATCH AG (SWATCH SA) (SWATCH LTD.), 94, Rue Jakob Stämpfli, CH-2502 BIENNE, CH

**WIPO Rahvusvah Tööstusdisainilahenduste****Bülletääni nr, kus registreering on avaldatud**

2004/07

(54) **Nimetus****Jewelry, in particular necklace with pendant, bracelet, earrings, ring.**(55) **Reproduktsoon**

DM/065604-01



(11) <b>Rahvusvah reg nr</b>	<b>DM/065606</b>	(51) <b>Klass:</b> <b>02-07</b>
(21) <b>Rahvusvah reg jrk</b>	H200400072	
(15) <b>Registreeringu päev</b>	20.07.2004	
(22) <b>Esitamise päev</b>	20.07.2004	
(28) <b>Variantide arv</b>	1	
(72) <b>Autor</b>	Nicolas Barth Nussbaumer, Rue St. Honoré 10, CH-2000 Neuchâtel, CH	
(73) <b>Omanik</b>	SWATCH AG (SWATCH SA) (SWATCH LTD.), 94, Rue Jakob Stämpfli, CH-2502 BIENNE, CH	
<b>WIPO Rahvusvah Tööstusdisainilahenduste Bülletääni nr, kus registreering on avaldatud</b>	2004/07	

(54) **Nimetus** **Cuff links**

(55) **Reproduktsoon**

DM/065606-01





(11) <b>Rahvusvah reg nr</b>	<b>DM/065609</b>	(51) Klass: <b>10-02</b>
(21) <b>Rahvusvah reg jrk</b>	H200400075	
(15) <b>Registreeringu päev</b>	20.07.2004	
(22) <b>Esitamise päev</b>	20.07.2004	
(28) <b>Variantide arv</b>	1	
(72) <b>Autor</b>	Andrea Arrigoni, SWATCHLAB, Via Archimede 6, IT-20129 MILANO, IT	
(73) <b>Omanik</b>	SWATCH AG (SWATCH SA) (SWATCH LTD.), 94, Rue Jakob Stämpfli, CH-2502 BIENNE, CH	

**WIPO Rahvusvah Tööstusdisainilahenduste  
Bülletääni nr, kus registreering on avaldatud** 2004/07

(54) **Nimetus** **Wristwatch**

(55) **Reproduksioon**

DM/065609-01



(11) **Rahvusvah reg nr****DM/065633**(51) Klass: **11-02**(21) **Rahvusvah reg jrk**

H200400077

(15) **Registreeringu päev**

19.07.2004

(22) **Esitamise päev**

19.07.2004

(28) **Variantide arv**

3

(30) **Prioriteediandmed**

141403, 04.03.2004, EM

(72) **Autor***Autori andmeid ei avalikustata*(73) **Omanik**SWAROVSKI AKTIENGESELLSCHAFT, 15, Dröschstrasse,  
P.O.Box 567, FL-9495 Triesen, LI**WIPO Rahvusvah Tööstusdisainilahenduste****Bülletääni nr, kus registreering on avaldatud** 2004/07(54) **Nimetus****Ornamental objects made of glass**(55) **Reproduksioon**

DM/065633-01

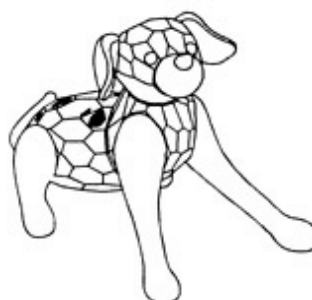
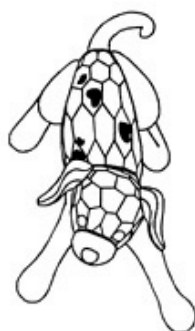
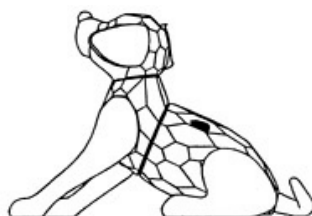

DM/065633-02

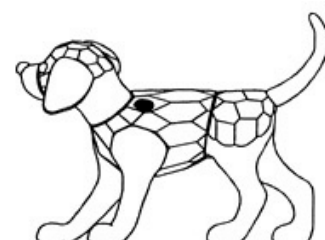
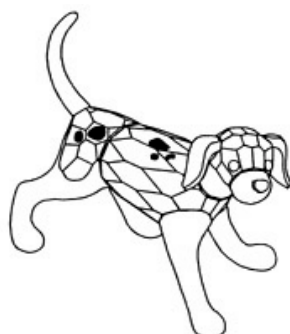
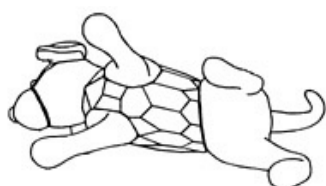

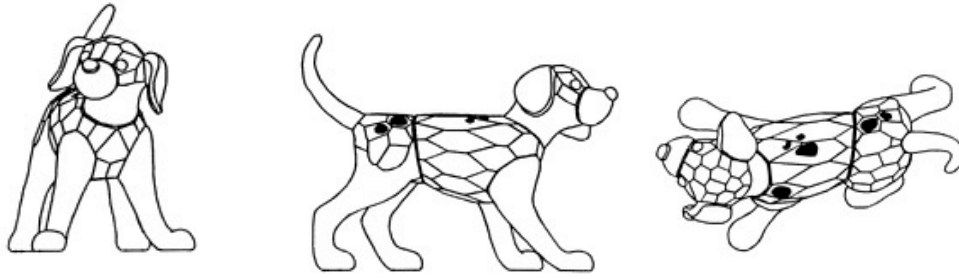

DM/065633-03

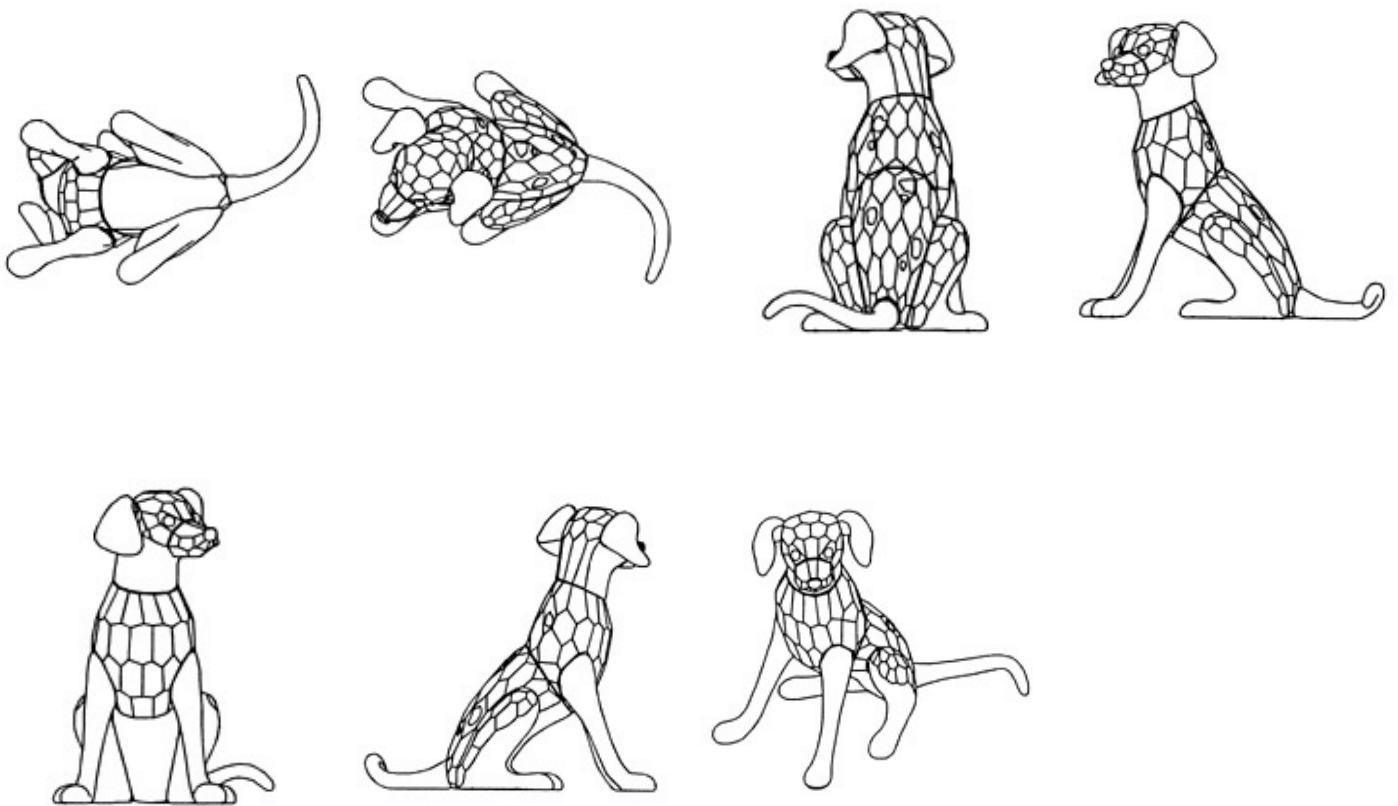

(11) <b>Rahvusvah reg nr</b>	<b>DM/065813</b>	(51) <b>Klass: 11-01</b>
(21) <b>Rahvusvah reg jrk</b>	H200400080	
(15) <b>Registreeringu päev</b>	31.08.2004	
(22) <b>Esitamise päev</b>	31.08.2004	
(28) <b>Variantide arv</b>	1	
(72) <b>Autor</b>	Nicolas Barth Nussbaumer, Rue St. Honoré 10, CH-2000 Neuchâtel, CH	
(73) <b>Omanik</b>	SWATCH AG (SWATCH SA) (SWATCH LTD.), 94, Rue Jakob Stämpfli, CH-2502 BIENNE, CH	

**WIPO Rahvusvah Tööstusdisainilahenduste**  
**Bülletääni nr, kus registreering on avaldatud** 2004/9

(54) **Nimetus** **Bracelet**

(55) **Reproduktsoon**

DM/065813-01

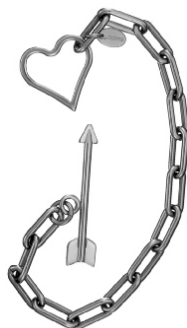
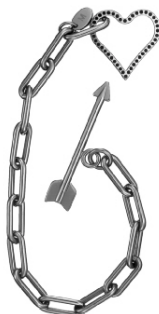

(11) <b>Rahvusvah reg nr</b>	<b>DM/065815</b>	(51) <b>Klass: 10-02</b>
(21) <b>Rahvusvah reg jrk</b>	H200400082	
(15) <b>Registreeringu päev</b>	31.08.2004	
(22) <b>Esitamise päev</b>	31.08.2004	
(28) <b>Variantide arv</b>	2	
(72) <b>Autor</b>	1. Nicole DUPONT, DUPONT DESIGN SA, Route des Jeunes 33, CH-1227 Carouge, CH 2. Fabrizio CUPPINI, SWATCHLAB, Via Archimede 6, IT-20129 MILANO, IT	
(73) <b>Omanik</b>	SWATCH AG (SWATCH SA) (SWATCHLTD.), 94, Rue Jakob Stämpfli, CH-2502 BIENNE, CH	
<b>WIPO Rahvusvah Tööstusdisainilahenduste Bülletääni nr, kus registreering on avaldatud</b>	2004/09	

(54) **Nimetus** **Wristwatches**

(55) **Reproduktsoon**

DM/065815-01



DM/065815-02



(11) <b>Rahvusvah reg nr</b>	<b>DM/065817</b>	(51) <b>Klass: 10-02</b>
(21) <b>Rahvusvah reg jrk</b>	H200400084	
(15) <b>Registreeringu päev</b>	31.08.2004	
(22) <b>Esitamise päev</b>	31.08.2004	
(28) <b>Variantide arv</b>	1	
(72) <b>Autor</b>	Malcolm DRAGOTTA, SWATCHLAB, Via Archimede 6, IT-20129 Milano, IT	
(73) <b>Omanik</b>	SWATCH AG (SWATCH SA) (SWATCH LTD.), 94, Rue Jakob Stämpfli, CH-2502 BIENNE, CH	
<b>WIPO Rahvusvah Tööstusdisainilahenduste Bülletääni nr, kus registreering on avaldatud</b>	2004/09	

(54) **Nimetus** **Wristwatch**

(55) **Reproduktsoon**

DM/065817-01



(11) <b>Rahvusvah reg nr</b>	<b>DM/065836</b>	(51) Klass: <b>10-02</b>
(21) <b>Rahvusvah reg jrk</b>	H200400088	
(15) <b>Registreeringu päev</b>	15.09.2004	
(22) <b>Esitamise päev</b>	15.09.2004	
(28) <b>Variantide arv</b>	1	
(72) <b>Autor</b>	Adelina BISSOLO, SWATCHLAB, Via Archimede 6, 20129 MILANO, IT	
(73) <b>Omanik</b>	SWATCH AG (SWATCH SA) (SWATCH LTD.), 94, Rue Jakob Stämpfli, CH-2502 BIENNE, CH	

**WIPO Rahvusvah Tööstusdisainilahenduste  
Bülletääni nr, kus registreering on avaldatud** 2004/09

(54) **Nimetus** **Wristwatch**

(55) **Reproduksioon**

DM/065836-01



(11) <b>Rahvusvah reg nr</b>	<b>DM/065953</b>	(51) Klass: <b>10-02</b>
(21) <b>Rahvusvah reg jrk</b>	H200400094	
(15) <b>Registreeringu päev</b>	18.10.2004	
(22) <b>Esitamise päev</b>	18.10.2004	
(28) <b>Variantide arv</b>	1	
(72) <b>Autor</b>	Nicole Dupont, Dupont Design SA, Rte des Jeunes 33, CH-1227 CAROUGE, CH	
(73) <b>Omanik</b>	SWATCH AG (SWATCH SA) (SWATCH LTD.), 94, Rue Jakob Stämpfli, CH-2502 BIENNE, CH	
<b>WIPO Rahvusvah Tööstusdisainilahenduste Bülletääni nr, kus registreering on avaldatud</b>	2004/10	

(54) **Nimetus** **Wristwatch**

(55) **Reproduktsoon**

DM/065953-01





(11) <b>Rahvusvah reg nr</b>	<b>DM/065959</b>	(51) Klass: <b>10-07</b>
(21) <b>Rahvusvah reg jrk</b>	H200400097	
(15) <b>Registreeringu päev</b>	18.10.2004	
(22) <b>Esitamise päev</b>	18.10.2004	
(28) <b>Variantide arv</b>	1	
(72) <b>Autor</b>	Nicole Dupont, Dupont Design SA, Rte des Jeunes 33, CH-1227 CAROUGE, CH	
(73) <b>Omanik</b>	SWATCH AG (SWATCH SA) (SWATCH LTD.), 94, Rue Jakob Stämpfli, CH-2502 BIENNE, CH	
<b>WIPO Rahvusvah Tööstusdisainilahenduste Bülletääni nr, kus registreering on avaldatud</b>	2004/10	

(54) **Nimetus** **Watch bracelet**

(55) **Reproduksioon**

DM/065959-01

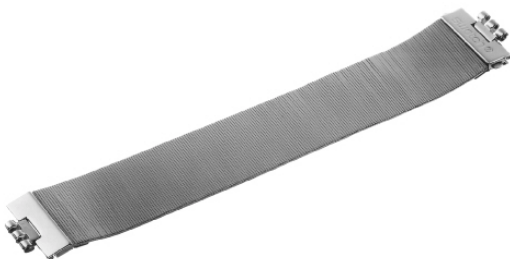

(11) <b>Rahvusvah reg nr</b>	<b>DM/066016</b>	(51) Klass: <b>10-02</b>
(21) <b>Rahvusvah reg jrk</b>	H200400100	
(15) <b>Registreeringu päev</b>	29.10.2004	
(22) <b>Esitamise päev</b>	29.10.2004	
(28) <b>Variantide arv</b>	9	
(72) <b>Autor</b>	1 OZLEM OLZER, Ali Pertek Sak 4, TR-34470 Rumelihisarik - Istanbul, TR 2 NIC RIPZ NEWTON, A NEW DAY GMBH, Laurenz-Sonderegger-Str. 3b, CH-9436 Balgach, CH 3, 4 ANDREA ARRIGONI, SWATCHLAB, Via Archimede 6, IT-20129 Milano, IT 5 LÉONIE COQUIO, DUPONT DESIGN SA, Route des Jeunes, CH-1227 Carouge/Geneva, CH 6, 8 ALESSANDRA FORNARI, SWATCHLAB, Via Archimede 6, IT-20129 Milano, IT 7, 9 ROSSANA BOFFI, SWATCHLAB, Via Archimede 6, IT-20129 Milano, IT	
(73) <b>Omanik</b>	SWATCHAG (SWATCH SA) (SWATCHLTD.), 94, Rue Jakob Stämpfli, CH-2502 BIENNE, CH	

**WIPO Rahvusvah Tööstusdisainilahenduste Bülletääni nr, kus registreering on avaldatud** 2004/11

(54) **Nimetus** **Wristwatches**

(55) **Reproduksioon**

DM/066016-01



DM/066016-02



DM/066016-03



DM/066016-04



DM/066016-05



DM/066016-06



DM/066016-07



DM/066016-08



DM/066016-09



(11) <b>Rahvusvah reg nr</b>	<b>DM/066031</b>	(51) <b>Klass: 10-02</b>
(21) <b>Rahvusvah reg jrk</b>	H200400102	
(15) <b>Registreeringu päev</b>	29.10.2004	
(22) <b>Esitamise päev</b>	29.10.2004	
(28) <b>Variantide arv</b>	1	
(72) <b>Autor</b>	Paula Schulmann, SWATCHLAB, Via Archimede 6, IT-20129 MILANO, IT	
(73) <b>Omanik</b>	SWATCH AG (SWATCH SA) (SWATCH LTD.), 94, Rue Jakob Stämpfli, CH-2502 BIENNE, CH	
<b>WIPO Rahvusvah Tööstusdisainilahenduste Bülletääni nr, kus registreering on avaldatud</b>	2004/11	

(54) **Nimetus** **Wristwatch**

(55) **Reproduksioon**

DM/066031-01



- (11) **Rahvusvah reg nr** DM/066032 (51) Klass: **10-07**
- (21) **Rahvusvah reg jrk** H200400103
- (15) **Registreeringu päev** 29.10.2004
- (22) **Esitamise päev** 29.10.2004
- (28) **Variantide arv** 1
- (72) **Autor** Malcolm Dragotta, SWATCHLAB, Via Archimede 6, IT-20129 MILANO, IT
- (73) **Omanik** SWATCH AG (SWATCH SA) (SWATCH LTD.), 94, Rue Jakob Stämpfli, CH-2502 BIENNE, CH

**WIPO Rahvusvah Tööstusdisainilahenduste**  
**Bülletääni nr, kus registreering on avaldatud** 2004/11

(54) **Nimetus** Watch bracelet

(55) **Reproduktsoon**

DM/066032-01



(11) **Rahvusvah reg nr****DM/066084**(51) Klass: **11-02**(21) **Rahvusvah reg jrk**

H200400105

(15) **Registreeringu päev**

22.11.2004

(22) **Esitamise päev**

22.11.2004

(28) **Variantide arv**

1

(30) **Prioriteediandmed**

190673, 17.06.2004, EM

(72) **Autor***Autori andmeid ei avalikustata*(73) **Omanik**SWAROVSKI AKTIENGESELLSCHAFT, 15, Dröschstrasse,  
P.O.Box 567, FL-9495 Triesen, LI**WIPO Rahvusvah Tööstusdisainilahenduste****Bülletääni nr, kus registreering on avaldatud** 2004/11(54) **Nimetus****Ornamental object made of glass**(55) **Reproduksioon**

DM/066084-01

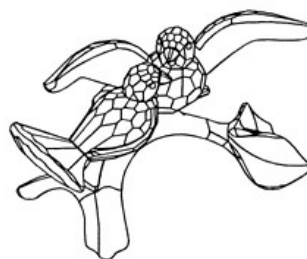
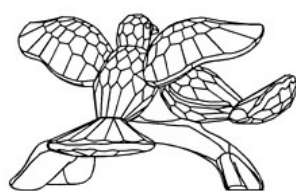
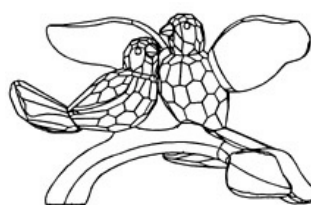
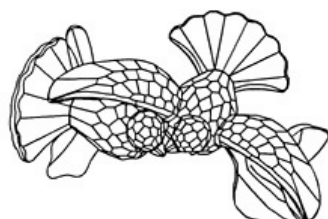
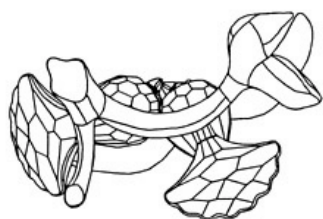

(11) <b>Rahvusvah reg nr</b>	<b>DM/066154</b>	(51) Klass: <b>10-07</b>
(21) <b>Rahvusvah reg jrk</b>	H200500003	
(15) <b>Registreeringu päev</b>	12.11.2004	
(22) <b>Esitamise päev</b>	12.11.2004	
(28) <b>Variantide arv</b>	1	
(72) <b>Autor</b>	Léonie COCQUIO, DUPONT DESIGN SA, Rte des Jeunes 33, CH-1227 Carouge/Genève, CH	
(73) <b>Omanik</b>	SWATCH AG (SWATCH SA) (SWATCH LTD.), 94, Rue Jakob Stämpfli, CH-2502 BIENNE, CH	
<b>WIPO Rahvusvah Tööstusdisainilahenduste Bülletääni nr, kus registreering on avaldatud</b>	2004/12	

(54) **Nimetus** **Watch band**

(55) **Reproduktsoon**

DM/066154-01



- (11) **Rahvusvah reg nr** **DM/066155** (51) Klass: **10-02**
- (21) **Rahvusvah reg jrk** H200500004
- (15) **Registreeringu päev** 12.11.2004
- (22) **Esitamise päev** 12.11.2004
- (28) **Variantide arv** 3
- (72) **Autor** 1 Rossana BOFFI, SWATCHLAB, Via Archimede 6, IT-20129 MILANO, IT  
2, 3 Andrea ARRIGONI, SWATCHLAB, Via Archimede 6, IT-20129 MILANO, IT
- (73) **Omanik** SWATCH AG (SWATCH SA) (SWATCHLTD.), 94, Rue Jakob Stämpfli, CH-2502 BIENNE, CH

**WIPO Rahvusvah Tööstusdisainilahenduste Bülletääni nr, kus registreering on avaldatud** 2004/12

(54) **Nimetus** **Wristwatches**

(55) **Reproduktsoon**

DM/066155-01



DM/066155-02



DM/066155-03





(11) <b>Rahvusvah reg nr</b>	<b>DM/066157</b>	(51) Klass: <b>10-02</b>
(21) <b>Rahvusvah reg jrk</b>	H200500006	
(15) <b>Registreeringu päev</b>	20.12.2004	
(22) <b>Esitamise päev</b>	20.12.2004	
(28) <b>Variantide arv</b>	2	
(72) <b>Autor</b>	1 Alessandra Fornari, SWATCHLAB, Via Archimede 6, IT-20129 Milano, IT 2 Léonie Cocquio, DUPONT DESIGN SA, Rte des Jeunes 33, CH-1227 Carouge, CH	
(73) <b>Omanik</b>	SWATCH AG (SWATCH SA) (SWATCHLTD.), 94, Rue Jakob Stämpfli, CH-2502 BIENNE, CH	
<b>WIPO Rahvusvah Tööstusdisainilahenduste Bülletääni nr, kus registreering on avaldatud</b>	2004/12	

(54) **Nimetus** **Wristwatches**

(55) **Reproduktsoon**

DM/066157-01



DM/066157-02



(11) <b>Rahvusvah reg nr</b>	<b>DM/066158</b>	(51) Klass: <b>10-02</b>
(21) <b>Rahvusvah reg jrk</b>	H200500007	
(15) <b>Registreeringu päev</b>	20.12.2004	
(22) <b>Esitamise päev</b>	20.12.2004	
(28) <b>Variantide arv</b>	1	
(72) <b>Autor</b>	Rossana BOFFI, Swatchlab, Via Archimede 6, 20129 Milano, IT	
(73) <b>Omanik</b>	SWATCH AG (SWATCH SA) (SWATCH LTD.), 94, Rue Jakob Stämpfli, CH-2502 BIENNE, CH	
<b>WIPO Rahvusvah Tööstusdisainilahenduste Bülletääni nr, kus registreering on avaldatud</b>	2004/12	

(54) **Nimetus** **Wristwatch**

(55) **Reproduktsoon**

DM/066158-01



(11) <b>Rahvusvah reg nr</b>	<b>DM/066159</b>	(51) Klass: <b>10-07</b>
(21) <b>Rahvusvah reg jrk</b>	H200500008	
(15) <b>Registreeringu päev</b>	20.12.2004	
(22) <b>Esitamise päev</b>	20.12.2004	
(28) <b>Variantide arv</b>	1	
(72) <b>Autor</b>	Theodora Quiriconi, DUPONT DESIGN SA, Rte des Jeunes 33, CH-1227 Carouge, CH	
(73) <b>Omanik</b>	SWATCH AG (SWATCH SA) (SWATCH LTD.), 94, Rue Jakob Stämpfli, CH-2502 BIENNE, CH	
<b>WIPO Rahvusvah Tööstusdisainilahenduste Bülletääni nr, kus registreering on avaldatud</b>	2004/12	

(54) **Nimetus** **Watch band**

(55) **Reproduktsoon**

DM/066159-01



(11) <b>Rahvusvah reg nr</b>	<b>DM/066178</b>	(51) Klass: <b>10-02</b>
(21) <b>Rahvusvah reg jrk</b>	H200500014	
(15) <b>Registreeringu päev</b>	20.12.2004	
(22) <b>Esitamise päev</b>	20.12.2004	
(28) <b>Variantide arv</b>	1	
(72) <b>Autor</b>	Arnaud Blaszyk, DUPONT DESIGN SA, Rte des Jeunes 33, CH-1227 Carouge, CH	
(73) <b>Omanik</b>	SWATCH AG (SWATCH SA) (SWATCH LTD.), 94, Rue Jakob Stämpfli, CH-2502 BIENNE, CH	
<b>WIPO Rahvusvah Tööstusdisainilahenduste Bülletääni nr, kus registreering on avaldatud</b>	2004/12	

(54) **Nimetus** **Wristwatch**

(55) **Reproduktsoon**

DM/066178-01



(11) <b>Rahvusvah reg nr</b>	<b>DM/066179</b>	(51) Klass: <b>10-02</b>
(21) <b>Rahvusvah reg jrk</b>	H200500015	
(15) <b>Registreeringu päev</b>	20.12.2004	
(22) <b>Esitamise päev</b>	20.12.2004	
(28) <b>Variantide arv</b>	1	
(72) <b>Autor</b>	Nicole DUPONT, Dupont Design SA, Rte des Jeunes 33, CH-1227 Carouge/Genève, CH	
(73) <b>Omanik</b>	SWATCH AG (SWATCH SA) (SWATCH LTD.), 94, Rue Jakob Stämpfli, CH-2502 BIENNE, CH	
<b>WIPO Rahvusvah Tööstusdisainilahenduste Bülletääni nr, kus registreering on avaldatud</b>	2004/12	

(54) **Nimetus** **Wristwatch**

(55) **Reproduksioon**

DM/066179-01



(11) <b>Rahvusvah reg nr</b>	<b>DM/066181</b>	(51) Klass: <b>10-02</b>
(21) <b>Rahvusvah reg jrk</b>	H200500017	
(15) <b>Registreeringu päev</b>	20.12.2004	
(22) <b>Esitamise päev</b>	20.12.2004	
(28) <b>Variantide arv</b>	1	
(72) <b>Autor</b>	Nicz RIPZ, A New Day GmbH, Laurenz-Sond. Str. 3b, CH-9436 Balgach, CH	
(73) <b>Omanik</b>	SWATCH AG (SWATCH SA) (SWATCH LTD.), 94, Rue Jakob Stämpfli, CH-2502 BIENNE, CH	
<b>WIPO Rahvusvah Tööstusdisainilahenduste Bülletääni nr, kus registreering on avaldatud</b>	2004/12	

(54) **Nimetus** **Wristwatch**

(55) **Reproduktsoon**

DM/066181-01



(11) <b>Rahvusvah reg nr</b>	<b>DM/066182</b>	(51) Klass: <b>10-02</b>
(21) <b>Rahvusvah reg jrk</b>	H200500018	
(15) <b>Registreeringu päev</b>	20.12.2004	
(22) <b>Esitamise päev</b>	20.12.2004	
(28) <b>Variantide arv</b>	1	
(72) <b>Autor</b>	Theodora Quiriconi, DUPONT DESIGN SA, Rte des Jeunes 33, CH-1227 Carouge, CH	
(73) <b>Omanik</b>	SWATCH AG (SWATCH SA) (SWATCH LTD.), 94, Rue Jakob Stämpfli, CH-2502 BIENNE, CH	

**WIPO Rahvusvah Tööstusdisainilahenduste  
Bülletääni nr, kus registreering on avaldatud** 2004/12

(54) **Nimetus** **Wristwatch**

(55) **Reproduksioon**

DM/066182-01



(11) <b>Rahvusvah reg nr</b>	<b>DM/066184</b>	(51) Klass: <b>10-02</b>
(21) <b>Rahvusvah reg jrk</b>	H200500020	
(15) <b>Registreeringu päev</b>	12.11.2004	
(22) <b>Esitamise päev</b>	12.11.2004	
(28) <b>Variantide arv</b>	1	
(72) <b>Autor</b>	Léonie COCQUIO, DUPONT DESIGN SA, Rte des Jeunes 33, CH-1227 Carouge/Genève, CH	
(73) <b>Omanik</b>	SWATCH AG (SWATCH SA) (SWATCH LTD.), 94, Rue Jakob Stämpfli, CH-2502 BIENNE, CH	

**WIPO Rahvusvah Tööstusdisainilahenduste  
Bülletääni nr, kus registreering on avaldatud** 2004/12

(54) **Nimetus** **Wristwatch**

(55) **Reproduksioon**

DM/066184-01





(11) <b>Rahvusvah reg nr</b>	<b>DM/066188</b>	(51) Klass: <b>10-02</b>
(21) <b>Rahvusvah reg jrk</b>	H200500022	
(15) <b>Registreeringu päev</b>	06.01.2005	
(22) <b>Esitamise päev</b>	06.01.2005	
(28) <b>Variantide arv</b>	1	
(72) <b>Autor</b>	Clara Baudet, DUPONT DESIGN SA, Route des Jeunes 33, CH-1227 CAROUGE, CH	
(73) <b>Omanik</b>	SWATCH AG (SWATCH SA) (SWATCH LTD.), 94, Rue Jakob Stämpfli, CH-2502 BIENNE, CH	

**WIPO Rahvusvah Tööstusdisainilahenduste  
Bülletääni nr, kus registreering on avaldatud** 2005/01

(54) **Nimetus** **Wristwatch**

(55) **Reproduksioon**

DM/066188-01



- (11) **Rahvusvah reg nr** **DM/066190** (51) Klass: **10-02**
- (21) **Rahvusvah reg jrk** H200500024
- (15) **Registreeringu päev** 28.12.2004
- (22) **Esitamise päev** 28.12.2004
- (28) **Variantide arv** 2
- (72) **Autor** 1 Katia De Conti, DUPONT DESIGN SA, Rte des Jeunes 33,  
CH-1227 Carouge, CH  
2 Nicole Dupont, DUPONT DESIGN SA, Route des Jeunes 33,  
CH-1227 CAROUGE, CH
- (73) **Omanik** SWATCH AG (SWATCH SA) (SWATCH LTD.), 94, Rue Jakob Stämpfli,  
CH-2502 BIENNE, CH
- WIPO Rahvusvah Tööstusdisainilahenduste**  
**Bülletääni nr, kus registreering on avaldatud** 2005/01

(54) **Nimetus** **Wristwatches**

(55) **Reproduktsoon**

DM/066190-01



DM/066190-02



(11) <b>Rahvusvah reg nr</b>	<b>DM/066191</b>	(51) Klass: <b>10-02</b>
(21) <b>Rahvusvah reg jrk</b>	H200500025	
(15) <b>Registreeringu päev</b>	28.12.2004	
(22) <b>Esitamise päev</b>	28.12.2004	
(28) <b>Variantide arv</b>	1	
(72) <b>Autor</b>	Rossana BOFFI, Swatchlab, Via Archimede 6, 20129 Milano, IT	
(73) <b>Omanik</b>	SWATCH AG (SWATCH SA) (SWATCH LTD.), 94, Rue Jakob Stämpfli, CH-2502 BIENNE, CH	
<b>WIPO Rahvusvah Tööstusdisainilahenduste Bülletääni nr, kus registreering on avaldatud</b>	2005/01	

(54) **Nimetus** **Wristwatch**

(55) **Reproduktsoon**

DM/066191-01



- (11) **Rahvusvah reg nr** DM/066192 (51) Klass: **10-07**
- (21) **Rahvusvah reg jrk** H200500026
- (15) **Registreeringu päev** 28.12.2004
- (22) **Esitamise päev** 28.12.2004
- (28) **Variantide arv** 1
- (72) **Autor** Fabrizio CUPPINI, SWATCHLAB, Via Archimede 6,  
IT-20129 MILANO, IT
- (73) **Omanik** SWATCH AG (SWATCH SA) (SWATCHLTD.), 94, Rue Jakob Stämpfli,  
CH-2502 BIENNE, CH

**WIPO Rahvusvah Tööstusdisainilahenduste  
Bülletääni nr, kus registreering on avaldatud** 2005/01

(54) **Nimetus** Watch strap

(55) **Reproduktsoon**

DM/066192-01



(11) <b>Rahvusvah reg nr</b>	<b>DM/066193</b>	(51) Klass: <b>10-02</b>
(21) <b>Rahvusvah reg jrk</b>	H200500027	
(15) <b>Registreeringu päev</b>	28.12.2004	
(22) <b>Esitamise päev</b>	28.12.2004	
(28) <b>Variantide arv</b>	2	
(72) <b>Autor</b>	1 Malcolm Dragotta, SWATCHLAB, Via Archimede 6, IT-20129 MILANO, IT 2 Nicole Dupont, DUPONT DESIGN SA, Route des Jeunes 33, CH-1227 CAROUGE, CH	
(73) <b>Omanik</b>	SWATCH AG (SWATCH SA) (SWATCH LTD.), 94, Rue Jakob Stämpfli, CH-2502 BIENNE, CH	
<b>WIPO Rahvusvah Tööstusdisainilahenduste Bülletääni nr, kus registreering on avaldatud</b>	2005/01	

(54) **Nimetus** **Wristwatches**

(55) **Reproduktsoon**

DM/066193-01



DM/066193-02



(11) <b>Rahvusvah reg nr</b>	<b>DM/066195</b>	(51) Klass: <b>10-02</b>
(21) <b>Rahvusvah reg jrk</b>	H200500029	
(15) <b>Registreeringu päev</b>	28.12.2004	
(22) <b>Esitamise päev</b>	28.12.2004	
(28) <b>Variantide arv</b>	1	
(72) <b>Autor</b>	Fabrizio CUPPINI, SWATCHLAB, Via Archimede 6, IT-20129 MILANO, IT	
(73) <b>Omanik</b>	SWATCH AG (SWATCH SA) (SWATCH LTD.), 94, Rue Jakob Stämpfli, CH-2502 BIENNE, CH	

**WIPO Rahvusvah Tööstusdisainilahenduste  
Bülletääni nr, kus registreering on avaldatud** 2005/01

(54) **Nimetus** **Wristwatch**

(55) **Reproduksioon**

DM/066195-01



(11) **Rahvusvah reg nr**

**DM/066196**

(51) Klass: **10-02**

(21) **Rahvusvah reg jrk**

H200500030

(15) **Registreeringu päev**

28.12.2004

(22) **Esitamise päev**

28.12.2004

(28) **Variantide arv**

1

(72) **Autor**

*Autori andmeid ei avalikustata*

(73) **Omanik**

TISSOT S.A., 17, chemin des Tourelles, CH-2400 Le Locle, CH

**WIPO Rahvusvah Tööstusdisainilahenduste**

**Bülletääni nr, kus registreering on avaldatud** 2005/01

(54) **Nimetus**

**Watch case with bracelet**

(55) **Reproduksioon**

DM/066196-01



(11) <b>Rahvusvah reg nr</b>	<b>DM/066197</b>	(51) <b>Klass: 10-02</b>
(21) <b>Rahvusvah reg jrk</b>	H200500031	
(15) <b>Registreeringu päev</b>	28.12.2004	
(22) <b>Esitamise päev</b>	28.12.2004	
(28) <b>Variantide arv</b>	1	
(72) <b>Autor</b>	Mireille GUINARD, 8 chemin du Grand Mont, FR-25500 MORTEAU, FR	
(73) <b>Omanik</b>	TISSOT S.A., 17, chemin des Tourelles, CH-2400 Le Locle, CH	
<b>WIPO Rahvusvah Tööstusdisainilahenduste</b>		
<b>Bülletääni nr, kus registreering on avaldatud</b>	2005/01	

(54) **Nimetus** **Watch case with bracelet**

(55) **Reproduksioon**

DM/066197-01

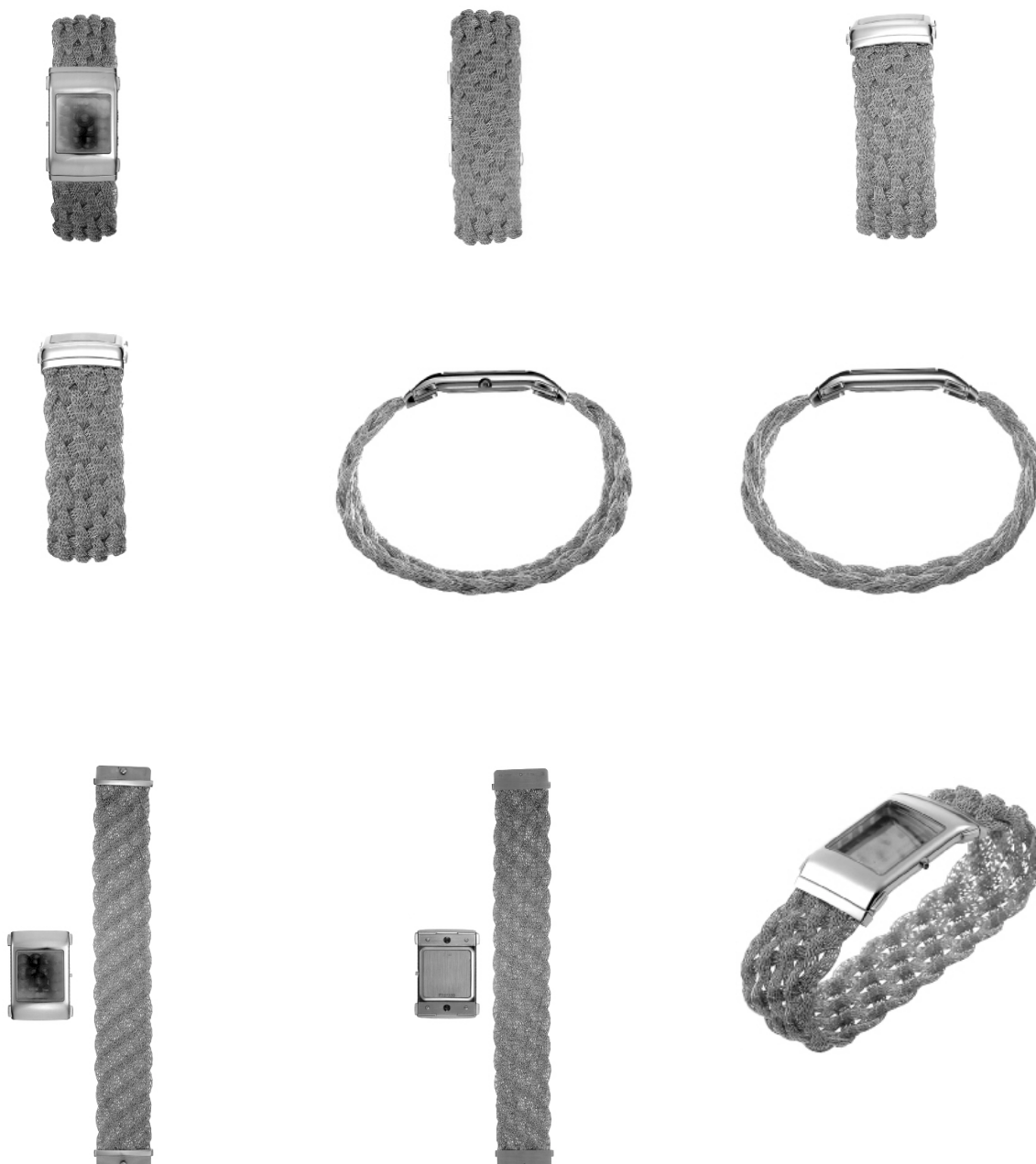



(11) <b>Rahvusvah reg nr</b>	<b>DM/066199</b>	(51) Klass: <b>11-01</b>
(21) <b>Rahvusvah reg jrk</b>	H200500033	
(15) <b>Registreeringu päev</b>	28.12.2004	
(22) <b>Esitamise päev</b>	28.12.2004	
(28) <b>Komplektide arv</b>	1	
(72) <b>Autor</b>	Nicolas Barth-Nussbaumer, Rue St-Honoré 10, CH-2000 NEUCHATEL, CH	
(73) <b>Omanik</b>	SWATCH AG (SWATCH SA) (SWATCH LTD.), 94, Rue Jakob Stämpfli, CH-2502 BIENNE, CH	

**WIPO Rahvusvah Tööstusdisainilahenduste**  
**Bülletääni nr, kus registreering on avaldatud** 2005/01

(54) **Nimetus** Jewellery, including ring and necklace

(55) **Reproduksioon**

DM/066199-01

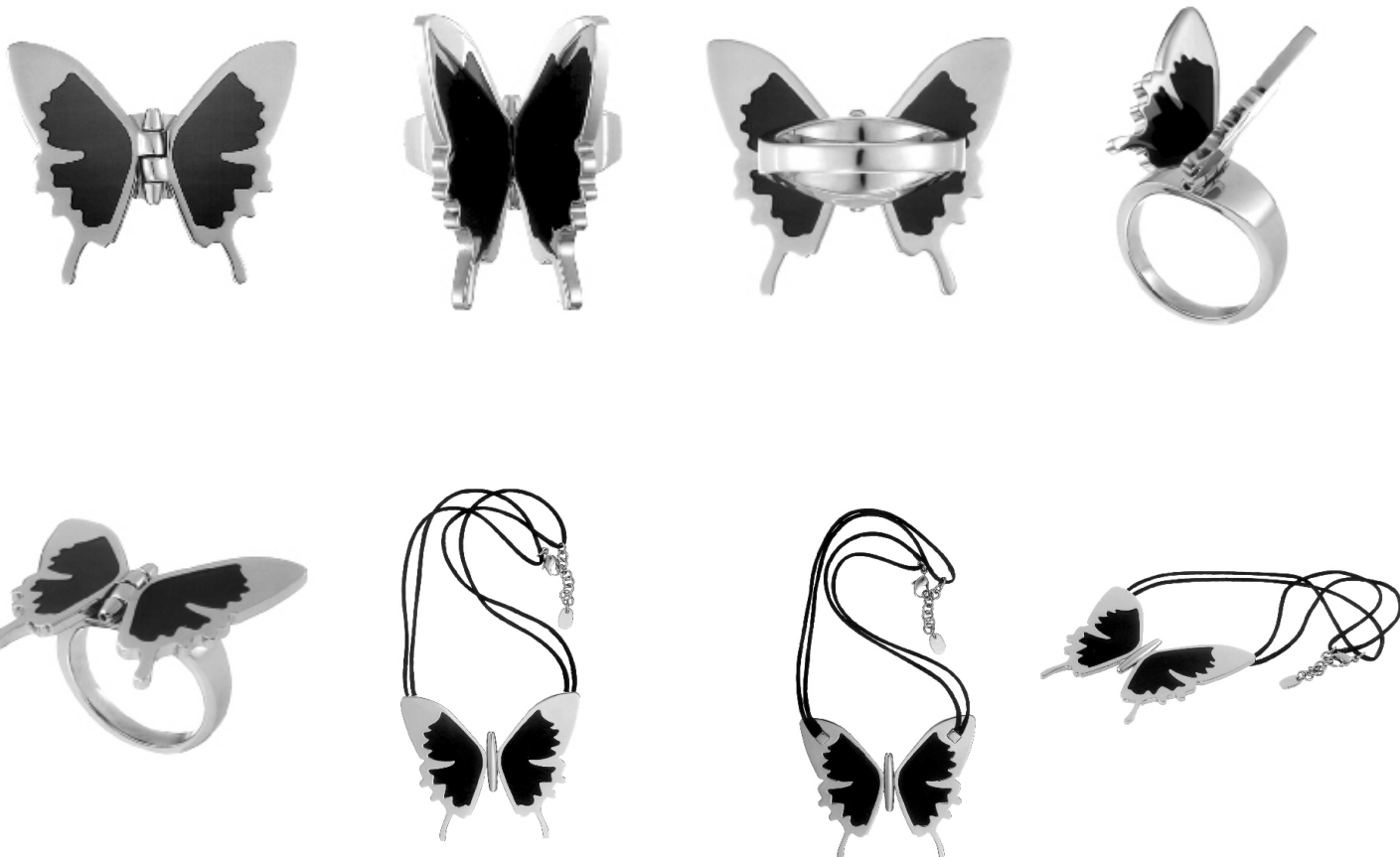

(11) <b>Rahvusvah reg nr</b>	<b>DM/066205</b>	(51) Klass: <b>10-02</b>
(21) <b>Rahvusvah reg jrk</b>	H200500035	
(15) <b>Registreeringu päev</b>	06.01.2005	
(22) <b>Esitamise päev</b>	06.01.2005	
(28) <b>Variantide arv</b>	1	
(72) <b>Autor</b>	Fabrizio CUPPINI, SWATCHLAB, Via Archimede 6, IT-20129 MILANO, IT	
(73) <b>Omanik</b>	SWATCH AG (SWATCH SA) (SWATCH LTD.), 94, Rue Jakob Stämpfli, CH-2502 BIENNE, CH	

**WIPO Rahvusvah Tööstusdisainilahenduste  
Bülletääni nr, kus registreering on avaldatud** 2005/01

(54) **Nimetus** **Wristwatch**

(55) **Reproduksioon**

DM/066205-01



(11) **Rahvusvah reg nr****DM/066245**(51) Klass: **20-02**(21) **Rahvusvah reg jrk**

H200500037

(15) **Registreeringu päev**

07.01.2005

(22) **Esitamise päev**

07.01.2005

(28) **Variantide arv**

1

(72) **Autor**

Luca Tonella, SWATCH SA, 94, rue Jakob-Stämpfli, CH-2502 Bienne, CH

(73) **Omanik**

SWATCH AG (SWATCH SA) (SWATCH LTD.), 94, Rue Jakob Stämpfli, CH-2502 BIENNE, CH

**WIPO Rahvusvah Tööstusdisainilahenduste  
Bülletääni nr, kus registreering on avaldatud**

2005/01

(54) **Nimetus****Display**(55) **Reproduksioon**

DM/066245-01

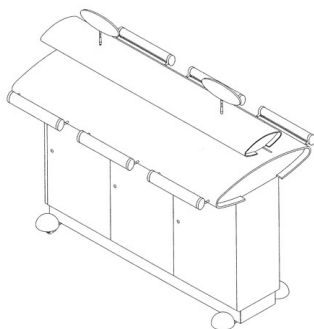
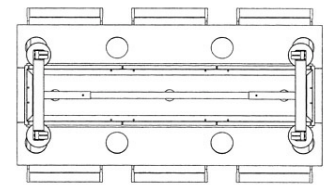
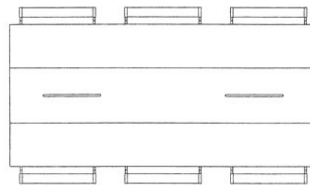
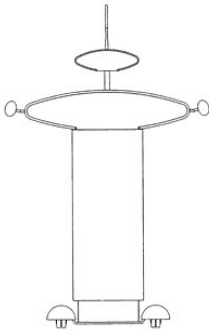
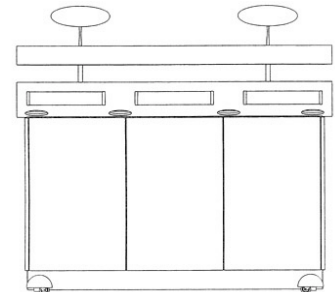
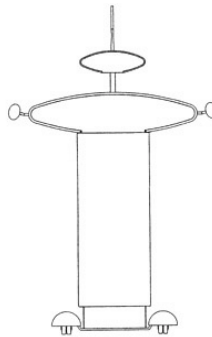
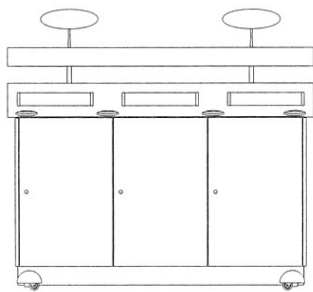

(11) <b>Rahvusvah reg nr</b>	<b>DM/066257</b>	(51) Klass: <b>11-01</b>
(21) <b>Rahvusvah reg jrk</b>	H200500039	
(15) <b>Registreeringu päev</b>	28.12.2004	
(22) <b>Esitamise päev</b>	28.12.2004	
(28) <b>Variantide arv</b>	2	
(72) <b>Autor</b>	Nicolas Barth Nussbaumer, Rue St. Honoré 10, CH-2000 NEUCHÂTEL, CH Nadja Zerunian, CALVIN KLEIN INC. LTD., 205 West 39th Street, 3rd Fl., NEW YORK, NY 10018, US THE SWATCH GROUP MANAGEMENT SERVICES AG (THE SWATCH GROUP MANAGEMENT SERVICES SA), (THE SWATCH GROUP MANAGEMENT SERVICES LTD), Seevorstadt 6, CH-2502 Biel/Bienne, CH	
(73) <b>Omanik</b>		

**WIPO Rahvusvah Tööstusdisainilahenduste  
Bülletääni nr, kus registreering on avaldatud** 2005/01

(54) **Nimetus** **Jewellery, including rings**

(55) **Reproduksioon**

DM/066257-01



DM/066257-02



- (11) **Rahvusvah reg nr** DM/066257 (51) Klass: **11-01**
- (21) **Rahvusvah reg jrk** H200500039A
- (15) **Registreeringu päev** 28.12.2004
- (22) **Esitamise päev** 28.12.2004
- (28) **Variantide arv** 1
- (72) **Autor** Nicolas Barth Nussbaumer, Rue St. Honoré 10, CH-2000 Neuchâtel, CH  
Nadja Zerunian, CALVIN KLEIN INC. LTD.,  
205 West 39th Street, 3rd Fl., NEW YORK, NY 10018, US  
THE SWATCH GROUP MANAGEMENT SERVICES AG  
(THE SWATCH GROUP MANAGEMENT SERVICES SA),  
(THE SWATCH GROUP MANAGEMENT SERVICES LTD.),  
Seevorstadt 6, CH-2502 BIENNE, CH

**WIPO Rahvusvah Tööstusdisainilahenduste**  
**Bülletääni nr, kus registreering on avaldatud** 2005/01

(54) **Nimetus** Ring

(55) **Reproduksioon**

DM/066257-01



(11) <b>Rahvusvah reg nr</b>	<b>DM/066257</b>	(51) <b>Klass: 11-01</b>
(21) <b>Rahvusvah reg jrk</b>	H200500039B	
(15) <b>Registreeringu päev</b>	28.12.2004	
(22) <b>Esitamise päev</b>	28.12.2004	
(28) <b>Variantide arv</b>	1	
(72) <b>Autor</b>	Nicolas Barth Nussbaumer, Rue St. Honoré 10, CH-2000 Neuchâtel, CH Nadja Zerunian, CALVIN KLEIN INC. LTD., 205 West 39th Street, 3rd Fl., NEW YORK, NY 10018, US THE SWATCH GROUP MANAGEMENT SERVICES AG (THE SWATCH GROUP MANAGEMENT SERVICES SA), (THE SWATCH GROUP MANAGEMENT SERVICES LTD.), Seevorstadt 6, CH-2502 BIENNE, CH	
(73) <b>Omanik</b>		

**WIPO Rahvusvah Tööstusdisainilahenduste  
Bülletääni nr, kus registreering on avaldatud** 2005/01

(54) **Nimetus** **Bracelet**

(55) **Reproduksioon**

DM/066257-01



(11) <b>Rahvusvah reg nr</b>	<b>DM/066257</b>	(51) Klass: <b>11-01</b>
(21) <b>Rahvusvah reg jrk</b>	H200500039C	
(15) <b>Registreeringu päev</b>	28.12.2004	
(22) <b>Esitamise päev</b>	28.12.2004	
(28) <b>Variantide arv</b>	1	
(72) <b>Autor</b>	Nicolas Barth Nussbaumer, Rue St. Honoré 10, CH-2000 Neuchâtel, CH Nadja Zerunian, CALVIN KLEIN INC. LTD., 205 West 39th Street, 3rd Fl., NEW YORK, NY 10018, US THE SWATCH GROUP MANAGEMENT SERVICES AG (THE SWATCH GROUP MANAGEMENT SERVICES SA), (THE SWATCH GROUP MANAGEMENT SERVICES LTD.), Seevorstadt 6, CH-2502 BIENNE, CH	
(73) <b>Omanik</b>		
<b>WIPO Rahvusvah Tööstusdisainilahenduste Bülletääni nr, kus registreering on avaldatud</b>	2005/01	

(54) **Nimetus** **Bracelet**

(55) **Reproduksioon**

DM/066257-01



(11) <b>Rahvusvah reg nr</b>	<b>DM/066257</b>	(51) Klass: <b>11-01</b>
(21) <b>Rahvusvah reg jrk</b>	H200500039D	
(15) <b>Registreeringu päev</b>	28.12.2004	
(22) <b>Esitamise päev</b>	28.12.2004	
(28) <b>Komplektide arv</b>	1	
(72) <b>Autor</b>	Nicolas Barth Nussbaumer, Rue St. Honoré 10, CH-2000 Neuchâtel, CH Nadja Zerunian, CALVIN KLEIN INC. LTD., 205 West 39th Street, 3rd Fl., NEW YORK, NY 10018, US THE SWATCH GROUP MANAGEMENT SERVICES AG (THE SWATCH GROUP MANAGEMENT SERVICES SA), (THE SWATCH GROUP MANAGEMENT SERVICES LTD.), Seevorstadt 6, CH-2502 BIENNE, CH	
(73) <b>Omanik</b>		

**WIPO Rahvusvah Tööstusdisainilahenduste  
Bülletääni nr, kus registreering on avaldatud** 2005/01

(54) **Nimetus** **Jewellery, including earrings, necklaces**

(55) **Reproduksioon**

DM/066257-01

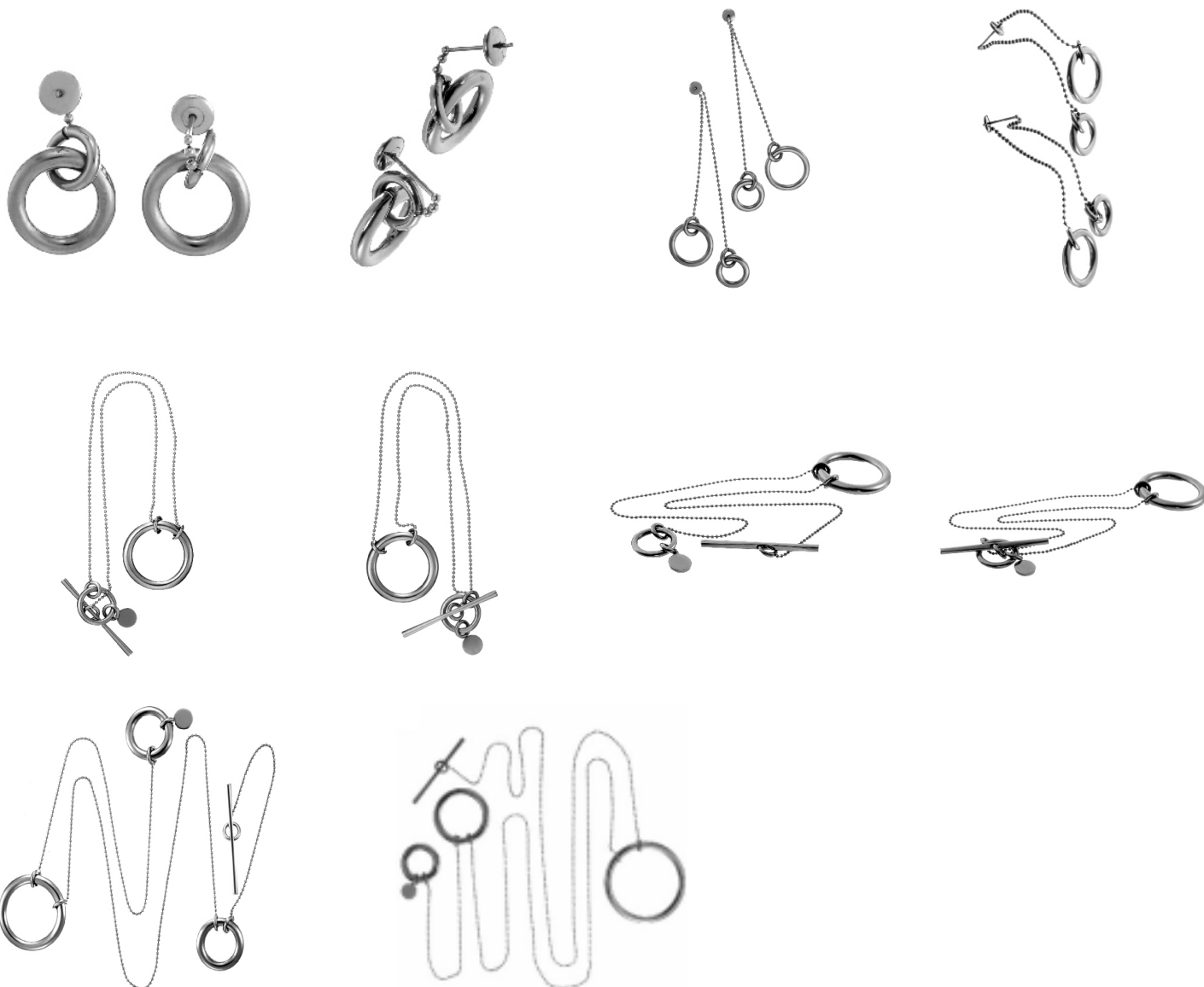



(11) <b>Rahvusvah reg nr</b>	<b>DM/066258</b>	(51) Klass: <b>10-02</b>
(21) <b>Rahvusvah reg jrk</b>	H200500040	
(15) <b>Registreeringu päev</b>	06.01.2005	
(22) <b>Esitamise päev</b>	06.01.2005	
(28) <b>Variantide arv</b>	1	
(72) <b>Autor</b>	Francesco Pastore, SWATCHLAB, Via Archimede 6, IT-20129 MILANO, IT	
(73) <b>Omanik</b>	SWATCH AG (SWATCH SA) (SWATCH LTD.), 94, Rue Jakob Stämpfli, CH-2502 BIENNE, CH	
<b>WIPO Rahvusvah Tööstusdisainilahenduste Bülletääni nr, kus registreering on avaldatud</b>	2005/01	

(54) **Nimetus** **Wristwatch**

(55) **Reproduktsoon**

DM/066258-01



(11) <b>Rahvusvah reg nr</b>	<b>DM/066259</b>	(51) Klass: <b>10-02</b>
(21) <b>Rahvusvah reg jrk</b>	H200500041	
(15) <b>Registreeringu päev</b>	06.01.2005	
(22) <b>Esitamise päev</b>	06.01.2005	
(28) <b>Variantide arv</b>	1	
(72) <b>Autor</b>	Malcolm DRAGOTTA, SWATCHLAB, Via Archimede 6, IT-20129 Milano, IT	
(73) <b>Omanik</b>	SWATCH AG (SWATCH SA) (SWATCH LTD.), 94, Rue Jakob Stämpfli, CH-2502 BIENNE, CH	
<b>WIPO Rahvusvah Tööstusdisainilahenduste Bülletääni nr, kus registreering on avaldatud</b>	2005/01	

(54) **Nimetus** **Wristwatch**

(55) **Reproduktsoon**

DM/066259-01



- (11) **Rahvusvah reg nr** DM/066281 (51) Klass: **10-07**
- (21) **Rahvusvah reg jrk** H200500043
- (15) **Registreeringu päev** 26.01.2005
- (22) **Esitamise päev** 26.01.2005
- (28) **Variantide arv** 1
- (72) **Autor** Malcolm DRAGOTTA, SWATCHLAB, Via Archimede 6,  
IT-20129 Milano, IT
- (73) **Omanik** SWATCH AG (SWATCH SA) (SWATCH LTD.), 94, Rue Jakob Stämpfli,  
CH-2502 BIENNE, CH

**WIPO Rahvusvah Tööstusdisainilahenduste  
Bülletääni nr, kus registreering on avaldatud** 2005/01

(54) **Nimetus** Watch strap

(55) **Reproduktsoon**

DM/066281-01

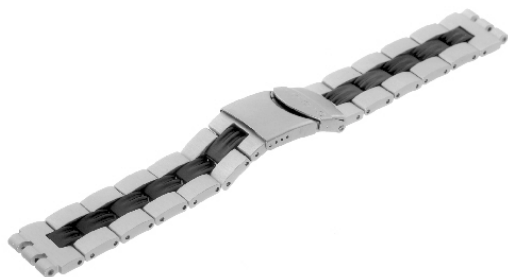

(11) <b>Rahvusvah reg nr</b>	<b>DM/066282</b>	(51) Klass: <b>10-02</b>
(21) <b>Rahvusvah reg jrk</b>	H200500044	
(15) <b>Registreeringu päev</b>	26.01.2005	
(22) <b>Esitamise päev</b>	26.01.2005	
(28) <b>Variantide arv</b>	1	
(72) <b>Autor</b>	Malcolm DRAGOTTA, SWATCHLAB, Via Archimede 6, IT-20129 Milano, IT	
(73) <b>Omanik</b>	SWATCH AG (SWATCH SA) (SWATCH LTD.), 94, Rue Jakob Stämpfli, CH-2502 BIENNE, CH	
<b>WIPO Rahvusvah Tööstusdisainilahenduste Bülletääni nr, kus registreering on avaldatud</b>	2005/01	

(54) **Nimetus** **Wristwatch**

(55) **Reproduksioon**

DM/066282-01



(11) <b>Rahvusvah reg nr</b>	<b>DM/066283</b>	(51) Klass: <b>10-02</b>
(21) <b>Rahvusvah reg jrk</b>	H200500045	
(15) <b>Registreeringu päev</b>	26.01.2005	
(22) <b>Esitamise päev</b>	26.01.2005	
(28) <b>Variantide arv</b>	1	
(72) <b>Autor</b>	Walter GARRO, SWATCHLAB, Via Archimede 6, IT-20129 MILANO, IT	
(73) <b>Omanik</b>	SWATCH AG (SWATCH SA) (SWATCH LTD.), 94, Rue Jakob Stämpfli, CH-2502 BIENNE, CH	

**WIPO Rahvusvah Tööstusdisainilahenduste  
Bülletääni nr, kus registreering on avaldatud** 2005/01

(54) **Nimetus** **Wristwatch**

(55) **Reproduksioon**

DM/066283-01



(11) <b>Rahvusvah reg nr</b>	<b>DM/066284</b>	(51) <b>Klass: 10-02</b>
(21) <b>Rahvusvah reg jrk</b>	H200500046	
(15) <b>Registreeringu päev</b>	26.01.2005	
(22) <b>Esitamise päev</b>	26.01.2005	
(28) <b>Variantide arv</b>	1	
(72) <b>Autor</b>	Andrea ARRIGONI, Swatchlab, Via Archimede 6, 20129 Milano, IT	
(73) <b>Omanik</b>	SWATCH AG (SWATCH SA) (SWATCH LTD.), 94, Rue Jakob Stämpfli, CH-2502 BIENNE, CH	
<b>WIPO Rahvusvah Tööstusdisainilahenduste Bülletääni nr, kus registreering on avaldatud</b>	2005/01	

(54) **Nimetus** **Wristwatch**

(55) **Reproduktsoon**

DM/066284-01



(11) <b>Rahvusvah reg nr</b>	<b>DM/066335</b>	(51) Klass: <b>10-07</b>
(21) <b>Rahvusvah reg jrk</b>	H200500050	
(15) <b>Registreeringu päev</b>	31.01.2005	
(22) <b>Esitamise päev</b>	31.01.2005	
(28) <b>Variantide arv</b>	1	
(72) <b>Autor</b>	Adelina BISSOLO, SWATCHLAB, Via Archimede 6, 20129 MILANO, IT	
(73) <b>Omanik</b>	SWATCH AG (SWATCH SA) (SWATCH LTD.), 94, Rue Jakob Stämpfli, CH-2502 BIENNE, CH	
<b>WIPO Rahvusvah Tööstusdisainilahenduste Bületääni nr, kus registreering on avaldatud</b>	2005/02	

(54) **Nimetus** **Watch strap decoration**

(55) **Reproduksioon**

DM/066335-01

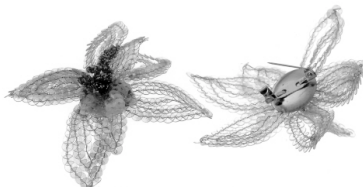
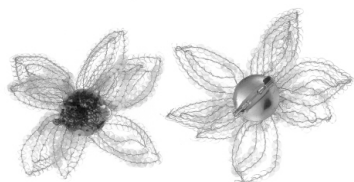

(11) <b>Rahvusvah reg nr</b>	<b>DM/066357</b>	(51) Klass: <b>10-02</b>
(21) <b>Rahvusvah reg jrk</b>	H200500053	
(15) <b>Registreeringu päev</b>	01.02.2005	
(22) <b>Esitamise päev</b>	01.02.2005	
(28) <b>Variantide arv</b>	2	
(72) <b>Autor</b>	Hakim EL KADIRI, Rue de Neuchâtel, CH-2072 ST-BLAISE, CH	
(73) <b>Omanik</b>	HAMILTON INTERNATIONAL AG (HAMILTON INTERNATIONAL SA)(HAMILTON INTERNATIONAL LTD.), Seevorstadt 6, CH-2502 Biel/Bienne, CH	

**WIPO Rahvusvah Tööstusdisainilahenduste**  
**Bülletääni nr, kus registreering on avaldatud** 2005/02

(54) **Nimetus** **Wristwatches**

(55) **Reproduksioon**

DM/066357-01





DM/066357-02



(11) <b>Rahvusvah reg nr</b>	<b>DM/066358</b>	(51) <b>Klass: 10-02</b>
(21) <b>Rahvusvah reg jrk</b>	H200500054	
(15) <b>Registreeringu päev</b>	01.02.2005	
(22) <b>Esitamise päev</b>	01.02.2005	
(28) <b>Variantide arv</b>	2	
(72) <b>Autor</b>	Monachon Jean-Claude, La Biche, CH-2054 LES VIEUX-PRÉS, CH	
(73) <b>Omanik</b>	OMEGA SA (OMEGA AG) (OMEGA LTD.), Jakob-Stämpfli-Strasse 96, CH-2502 Biel/Bienne, CH	

**WIPO Rahvusvah Tööstusdisainilahenduste**  
**Bülletääni nr, kus registreering on avaldatud** 2005/02

(54) **Nimetus** **Wristwatches**

(55) **Reproduktsoon**

DM/066358-01



DM/066358-02



(11) <b>Rahvusvah reg nr</b>	<b>DM/066380</b>	(51) Klass: <b>02-07</b>
(21) <b>Rahvusvah reg jrk</b>	H200500055	
(15) <b>Registreeringu päev</b>	28.02.2005	
(22) <b>Esitamise päev</b>	28.02.2005	
(28) <b>Variantide arv</b>	1	
(72) <b>Autor</b>	Arlette Elsa EMCH DUCOMMUN, rue des Mornets 31, CH-2520 LA NEUVEVILLE, CH	
(73) <b>Omanik</b>	OMEGA SA (OMEGA AG) (OMEGA LTD.), Jakob-Stämpfli-Strasse 96, CH-2502 Biel/Bienne, CH	
<b>WIPO Rahvusvah Tööstusdisainilahenduste Bülletääni nr, kus registreering on avaldatud</b>	2005/03	

(54) **Nimetus** **Cuff links**

(55) **Reproduksioon**

DM/066380-01



(11) **Rahvusvah reg nr****DM/066402**(51) Klass: **11-05**(21) **Rahvusvah reg jrk**

H200500060

(15) **Registreeringu päev**

25.01.2005

(22) **Esitamise päev**

25.01.2005

(28) **Komplektide arv**

1

(30) **Prioriteediandmed**

229406, 21.09.2004, EM

(72) **Autor***Autori andmeid ei avalikustata*(73) **Omanik**SWAROVSKI AKTIENGESELLSCHAFT, Dröschstrasse 15,  
FL-9495 Triesen, LI**WIPO Rahvusvah Tööstusdisainilahenduste****Bülletääni nr, kus registreering on avaldatud** 2005/03(54) **Nimetus****Christmas tree decorations**(55) **Reproduksioon**

DM/066402-01

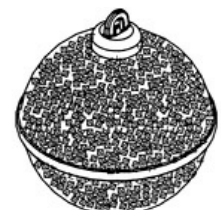
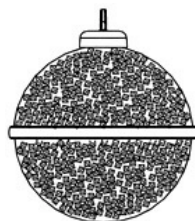
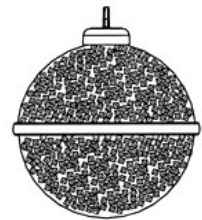
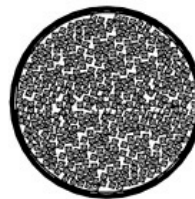

(11) <b>Rahvusvah reg nr</b>	<b>DM/066405</b>	(51) Klass: <b>10-02</b>
(21) <b>Rahvusvah reg jrk</b>	H200500061	
(15) <b>Registreeringu päev</b>	17.02.2005	
(22) <b>Esitamise päev</b>	17.02.2005	
(28) <b>Variantide arv</b>	1	
(72) <b>Autor</b>	Walter GARRO, SWATCHLAB, Via Archimede, 6, IT-20129 Milano, IT	
(73) <b>Omanik</b>	SWATCH AG (SWATCH SA) (SWATCH LTD.), 94, Rue Jakob Stämpfli, CH-2502 BIENNE, CH	
<b>WIPO Rahvusvah Tööstusdisainilahenduste Bülletääni nr, kus registreering on avaldatud</b>	2005/03	

(54) **Nimetus** **Wristwatch**

(55) **Reproduktsoon**

DM/066405-01



- (11) **Rahvusvah reg nr** DM/066406 (51) Klass: **11-01**
- (21) **Rahvusvah reg jrk** H200500062
- (15) **Registreeringu päev** 17.02.2005
- (22) **Esitamise päev** 17.02.2005
- (28) **Komplektide arv** 1
- (72) **Autor** Nicolas Barth Nussbaumer, Rue St. Honoré 10,  
CH-2000 NEUCHÂTEL, CH
- (73) **Omanik** SWATCH AG (SWATCH SA) (SWATCH LTD.), 94, Rue Jakob Stämpfli,  
CH-2502 BIENNE, CH

**WIPO Rahvusvah Tööstusdisainilahenduste**  
**Bülletääni nr, kus registreering on avaldatud** 2005/03

- (54) **Nimetus** Jewelry, particularly ring and brooch
- (55) **Reproduksioon**

DM/066406-01



(11) <b>Rahvusvah reg nr</b>	<b>DM/066425</b>	(51) Klass: <b>10-07</b>
(21) <b>Rahvusvah reg jrk</b>	H200500067	
(15) <b>Registreeringu päev</b>	16.03.2005	
(22) <b>Esitamise päev</b>	16.03.2005	
(28) <b>Variantide arv</b>	1	
(72) <b>Autor</b>	Manuel EMCH, MONTRES JAQUET DROZ SA (Montres Jaquet Droz AG)(Montres Jaquet Droz Ltd.), 5, rue Jaquet Droz, CH-2300 La Chaux-de-Fonds, CH	
(73) <b>Omanik</b>	MONTRES JAQUET DROZ SA (MONTRES JAQUET DROZ AG)(MONTRES JAQUET DROZ LTD.), 5, rue Jaquet Droz, CH-2300 La Chaux-de-Fonds, CH	
<b>WIPO Rahvusvah Tööstusdisainilahenduste Bülletääni nr, kus registreering on avaldatud</b>	2005/03	

(54) **Nimetus** **Watch dial**

(55) **Reproduktsoon**

DM/066425-01





(11) <b>Rahvusvah reg nr</b>	<b>DM/066466</b>	(51) <b>Klass: 11-01</b>
(21) <b>Rahvusvah reg jrk</b>	H200500072	
(15) <b>Registreeringu päev</b>	08.03.2005	
(22) <b>Esitamise päev</b>	08.03.2005	
(28) <b>Variantide arv</b>	1	
(72) <b>Autor</b>	Nicolas Barth Nussbaumer, Rue St. Honoré 10, CH-2000 Neuchâtel, CH	
(73) <b>Omanik</b>	SWATCH AG (SWATCH SA) (SWATCH LTD.), 94, Rue Jakob Stämpfli, CH-2502 BIENNE, CH	
<b>WIPO Rahvusvah Tööstusdisainilahenduste</b>		
<b>Bülletääni nr, kus registreering on avaldatud</b>	2005/03	

(54) **Nimetus** **Jewelry, particularly ring**

(55) **Reproduktsoon**

DM/066466-01



**III. REGISTREERINGU KEHTIVUSE PIKENDAMINE**

(11)	(18)
00466	25.02.2010
00481	19.07.2010
00485	14.08.2010
00486	06.09.2010
00503	16.10.2010
00505	30.10.2010
00507	29.09.2010
00508	20.11.2010
00509	21.11.2010
00552	24.11.2010
00558	26.09.2010

**VI. MUUD REGISTREERINGU ANDMETE MUUDATUSED**

Reg nr	Muudetud andmed	Registrikande jõustumise päev
00508	Glaxo Group Limited, Glaxo Wellcome House, Berkeley Avenue, Greenford, Middlesex UB6 0NN, GB	08.09.2005

**XI. TÖÖSTUSDISAINILAHENDUSE KUSTUTAMINE REGISTRIST**

"Tööstusdisaini kaitse seaduse" paragrahvi 77 lõike 1 alusel on registrist kustutatud järgmised tööstusdisainilahendused:

Reg nr	Kustutamise jõustumise päev
00456	10.04.2005
00457	10.04.2005
00460	02.03.2005
00461	02.03.2005
00479	31.01.2005
00504	08.03.2005

**XII. LOENDID****REGISTREERITUD TÖÖSTUSDISAINILAHENDUSTE SÜSTEMAATILINE LOEND**

Rahvusvahelise klassifikatsiooni klass ja alaklass(id)	Registreerimis-taotluse number	Registreeringu number
--	--------------------------------	-----------------------

02-05	D200500060	01117	14-03	D200500054	01115
05-05	D200500060	01117	14-03	D200500061	01118
13-02	D200500059	01116	14-03	D200500064	01119
13-02	D200500061	01118	23-02	D200500050	01114
14-01	D200500061	01118	24-01	D200500050	01114

**REGISTREERITUD TÖÖSTUSDISAINILAHENDUSTE REGISTREERIMISTAOTLUSTE NUMBRILINE LOEND**

Registreerimis-taotluse number	Registreeringu number	Rahvusvahelise klassifikatsiooni klass(id) ja alaklass(id)
--------------------------------	-----------------------	--

D200500050	01114	23-02	D200500060	01117	05-05
D200500050	01114	24-01	D200500061	01118	13-02
D200500054	01115	14-03	D200500061	01118	14-01
D200500059	01116	13-02	D200500061	01118	14-03
D200500060	01117	02-05	D200500064	01119	14-03

**AVALDATUD RAHVUSVAHELISE REGISTREERINGU REGISTREERIMISE OTSUSE TEADETE NUMBRILINE LOEND**

DM/065295	DM/065596	DM/066155	DM/066257
DM/065296	DM/065597	DM/066157	DM/066257
DM/065301	DM/065598	DM/066158	DM/066257
DM/065355	DM/065599	DM/066159	DM/066257
DM/065361	DM/065600	DM/066178	DM/066258
DM/065364	DM/065602	DM/066179	DM/066259
DM/065365	DM/065604	DM/066181	DM/066281
DM/065367	DM/065606	DM/066182	DM/066282
DM/065388	DM/065609	DM/066184	DM/066283
DM/065395	DM/065633	DM/066188	DM/066284
DM/065463	DM/065813	DM/066190	DM/066335
DM/065470	DM/065815	DM/066191	DM/066357
DM/065471	DM/065817	DM/066192	DM/066358
DM/065498	DM/065836	DM/066193	DM/066380
DM/065500	DM/065953	DM/066195	DM/066402
DM/065502	DM/065959	DM/066196	DM/066405
DM/065505	DM/066016	DM/066197	DM/066406
DM/065586	DM/066031	DM/066199	DM/066425
DM/065592	DM/066032	DM/066205	DM/066466
DM/065593	DM/066084	DM/066245	
DM/065595	DM/066154	DM/066257	

**XIII. TÖÖSTUSDISAINIALASED ÕIGUSAKTID JA MUU INFO****RIIKLIKUS PATENDIVOLNIKE REGISTRIS REGISTREERITUD PATENDIVOLNIKE NIMEKIRI**  
(seisuga 7. oktoober 2005)

Register on asutatud 1. septembril 2001. a Vabariigi Valitsuse 7. augusti 2001. a määrusega nr 271 "Riikliku patendivolinike registri asutamine ja registri pidamise põhimäärus" (RT I 2001, 70, 426) patendivoliniku seaduse § 21 alusel (RT I 2001, 27, 151).

**TEGEVUSVALDKOND: KAUBAMÄRK, TÖÖSTUSDISAINILAHENDUS JA GEOGRAAFILINE TÄHIS**

<b>Arno ANIJALG</b>	<b>OÜ USTERVALL</b> Raekoja plats 16 51004 Tartu pk 21, 50002 Tartu telefon: 744 1980 telefaks: 744 1785 e-post: anijalg@ustervall.ee <a href="http://www.ustervall.ee">http://www.ustervall.ee</a> võõrkeeled: saksa, vene	<b>Juhan HÄMMALOV</b>	<b>OÜ Intels</b> Riia 11-3 51010 Tartu telefon: 742 0401 telefaks: 742 0326 e-post: intelses@estpak.ee võõrkeeled: inglise, saksa, vene
<b>Aivo ARULA</b>	<b>Patendibüroo Käosaar &amp; Co OÜ</b> Tähe 94 50107 Tartu telefon: 738 3051 telefaks: 738 3055 e-post: info@kaosaar.ee <a href="http://www.kaosaar.ee">http://www.kaosaar.ee</a> võõrkeeled: inglise, vene	<b>Uno JÄÄGER</b>	<b>Inseneribüroo Uneko OÜ</b> Rüütli 51a, 80010 Pärnu telefon: 447 1021 telefaks: 447 1001 GSM: 515 1844 e-post: uno@estpak.ee võõrkeeled: inglise, soome, vene
<b>Martina BÖCKLER-LORVI</b>	<b>OÜ LASVET</b> Suurtüki 4a, 10133 Tallinn pk 3136, 10505 Tallinn telefon: 640 6600 telefaks: 640 6604 e-post: lasvet@lasvet.ee <a href="http://www.lasvet.ee">http://www.lasvet.ee</a> võõrkeeled: inglise, soome	<b>Sirje KAHU</b>	<b>OÜ USTERVALL</b> Raekoja plats 16 51004 Tartu pk 21, 50002 Tartu telefon: 744 1980 telefaks: 744 1785 e-post: skahu@ustervall.ee <a href="http://www.ustervall.ee">http://www.ustervall.ee</a> võõrkeeled: inglise, vene
<b>Indrek EELMETS</b>	<b>OÜ LASVET</b> Suurtüki 4a, 10133 Tallinn pk 3136, 10505 Tallinn telefon: 640 6600 telefaks: 640 6604 e-post: lasvet@lasvet.ee <a href="http://www.lasvet.ee">http://www.lasvet.ee</a> võõrkeeled: inglise, vene, soome	<b>Lembit KALEV</b>	<b>Patendibüroo ROOSILLA OÜ</b> Järveotsa tee 39-61 13520 Tallinn telefon: 657 1722, 657 5381 telefaks: 657 5381 GSM: 511 9951 e-post: roosilla@roosilla.ee <a href="http://www.roosilla.ee">http://www.roosilla.ee</a> võõrkeeled: inglise, vene
<b>Alla HÄMMALOV</b>	<b>OÜ Intels</b> Riia 11-3 51010 Tartu telefon: 742 0401 telefaks: 742 0326 e-post: intelses@estpak.ee võõrkeeled: inglise, poola, vene	<b>Anneli KANG</b>	<b>OÜ Synest</b> pk 977, 13402 Tallinn telefon: 660 9786 telefaks: 660 9787 e-post: anneli@synest.ee võõrkeeled: inglise, saksa, vene, prantsuse, soome, rootsi

- Urmas KAULER**      **Patendibüroo TURVAJA OÜ**  
 Liivalaia 22  
 10118 Tallinn  
 telefon: 640 3109  
 telefaks: 640 3105  
 e-post: kauler@turvaja.ee  
 http://www.turvaja.ee  
 võõrkeeled: inglise, vene, soome
- Urmas KERNU**      **AAA Patendibüroo OÜ**  
 Tartu mnt 16  
 10117 Tallinn  
 pk 3926, 10509 Tallinn  
 telefon: 660 5910, 660 5911  
 telefaks: 660 5912  
 e-post: aaa@aaa.ee  
 http://www.aaa.ee  
 võõrkeeled: inglise, saksa, soome, vene
- Ljubov KESSELMAN**      **OÜ Kesna**  
 Tedre 77-52  
 10616 Tallinn  
 telefon: 660 8068  
 telefaks: 660 8069  
 e-post: kesna@online.ee  
 võõrkeeled: inglise, vene
- Marina KESSELMAN**      **OÜ Kesna**  
 Tedre 77-52  
 10616 Tallinn  
 telefon: 660 8068  
 telefaks: 660 8069  
 e-post: kesna@online.ee  
 võõrkeeled: inglise, saksa, vene
- Heinu KOITEL**      **Patendi- & Kaubamärgibüroo Koitel OÜ**  
 Tartu mnt 65  
 10115 Tallinn  
 pk 1759, 10902 Tallinn  
 telefon: 603 3260  
 telefaks: 603 3261  
 e-post: koitel@koitel.ee  
 http://www.koitel.ee  
 võõrkeeled: inglise, soome, vene
- Raivo KOITEL**      **Patendi- & Kaubamärgibüroo Koitel OÜ**  
 Tartu mnt 65  
 10115 Tallinn  
 pk 1759, 10902 Tallinn  
 telefon: 603 3260  
 telefaks: 603 3261  
 e-post: koitel@koitel.ee  
 http://www.koitel.ee  
 võõrkeeled: inglise, soome, vene
- Mart Enn KOPPEL**      **Patendibüroo Koppel OÜ**  
 Kajaka 4-10  
 11317 Tallinn  
 telefon: 677 4136  
 telefaks: 677 4138  
 e-post: info@koppelpb.com  
 http://www.koppelpb.com  
 võõrkeeled: inglise, vene, soome
- Heinrich KRUPP**      **Patendibüroo TURVAJA OÜ**  
 Liivalaia 22  
 10118 Tallinn  
 telefon: 640 3109  
 telefaks: 640 3105  
 e-post: turvaja@turvaja.ee  
 http://www.turvaja.ee  
 võõrkeeled: saksa, vene
- Jüri KÄOSAAR**      **Patendibüroo Käosaar & Co OÜ**  
 Tähe 94  
 50107 Tartu  
 telefon: 738 3051  
 telefaks: 738 3055  
 e-post: info@kaosaar.ee  
 http://www.kaosaar.ee  
 võõrkeeled: inglise, vene
- Kalev KÄOSAAR**      **Patendibüroo Käosaar & Co OÜ**  
 Peterburi tee 46  
 11415 Tallinn  
 telefon: 637 9484  
 telefaks: 637 9485  
 e-post: kalev.kaosaar@kaosaar.ee  
 http://www.kaosaar.ee  
 võõrkeeled: inglise, vene
- Reet MAASIKAMÄE**      **OÜ Kaitsepurus**  
 Mulla 4-3  
 10611 Tallinn  
 telefon: 673 9097, 633 2798  
 telefaks: 677 4844  
 e-post: purus@online.ee  
 purus@hot.ee  
 http://www.hot.ee/purus/  
 võõrkeeled: inglise, vene
- Raivo MATSOO**      **RM Hirvela Patendibüroo OÜ**  
 Saku 15, 11314 Tallinn  
 telefon: 614 0816  
 telefaks: 614 0818  
 e-post: hirvela@hirvela.ee  
 võõrkeeled: inglise, vene

<b>Elle MELLIK</b>	<b>AAA Patendibüroo OÜ</b> Tartu mnt 16 10117 Tallinn pk 3926, 10509 Tallinn telefon: 660 5910, 660 5911 telefaks: 660 5912 e-post: aaa@aaa.ee http://www.aaa.ee võõrkeeled: inglise, vene	<b>Jaak OSTRAT</b>	<b>OÜ LASVET</b> Suurtüki 4a, 10133 Tallinn pk 3136, 10505 Tallinn telefon: 640 6600 telefaks: 640 6604 e-post: lasvet@lasvet.ee http://www.lasvet.ee võõrkeeled: inglise, saksa, soome, vene
<b>Lembit MITT</b>	<b>AAA Patendibüroo OÜ</b> Tartu mnt 16 10117 Tallinn pk 3926, 10509 Tallinn telefon: 660 5910, 660 5911 telefaks: 660 5912 e-post: aaa@aaa.ee http://www.aaa.ee võõrkeeled: inglise, vene	<b>Villu PAVELTS</b>	<b>OÜ LASVET</b> Suurtüki 4a, 10133 Tallinn pk 3136, 10505 Tallinn telefon: 640 6600 telefaks: 640 6604 e-post: lasvet@lasvet.ee http://www.lasvet.ee võõrkeeled: inglise, soome, vene
<b>Ott MOORLAT</b>	<b>OÜ Moorlat &amp; Ko Patendibüroo</b> pk 723, 12902 Tallinn telefon: 655 0450, 654 2844 telefaks: 654 2844 e-post: ott.moorlat@moorlat.ee http://www.moorlat.ee võõrkeeled: inglise, vene	<b>Toom PUNGAS</b>	<b>OÜ Synest</b> pk 977, 13402 Tallinn telefon: 660 9786 telefaks: 660 9787 e-post: toom@synest.ee võõrkeeled: inglise, saksa, soome, vene
<b>Anfia MORNA</b>	<b>Patendibüroo TURVAJA OÜ</b> Liivalaia 22, 10118 Tallinn telefon: 640 3109 telefaks: 640 3105 e-post: morna@turvaja.ee http://www.turvaja.ee võõrkeeled: inglise, vene	<b>Kaie PUUR</b>	<b>Patendibüroo Käosaar &amp; Co OÜ</b> Tähe 94 50107 Tartu telefon: 738 3051 telefaks: 738 3055 e-post: info@kaosaar.ee http://www.kaosaar.ee võõrkeeled: inglise, vene
<b>Tõnu NELNAS</b>	<b>AAA Patendibüroo OÜ</b> Tartu mnt 16 10117 Tallinn pk 3926, 10509 Tallinn telefon: 660 5910, 660 5911 telefaks: 660 5912 e-post: aaa@aaa.ee http://www.aaa.ee võõrkeeled: inglise, vene, soome	<b>Riina PÄRN</b>	<b>OÜ Intels</b> Riia 11-3 51010 Tartu telefon: 742 0401 telefaks: 742 0326 e-post: intelses@estpak.ee võõrkeeled: inglise, vene
<b>Jüri OLT</b>	<b>Patendibüroo Käosaar &amp; Co OÜ</b> Tähe 94, 50107 Tartu telefon: 738 3051 telefaks: 738 3055 e-post: info@kaosaar.ee http://www.kaosaar.ee võõrkeeled: inglise, saksa, soome, vene	<b>Tarmo ROSMAN</b>	<b>Rosman ja Partnerid OÜ</b> pk 652, 12602 Tallinn telefon: 656 1450 telefaks: 656 1450 e-post: tarman@cc.ttu.ee võõrkeeled: saksa, inglise, ungari, vene
		<b>Arvo SALUMÄE</b>	<b>OÜ Amende Patendibüroo</b> Raua 65 10152 Tallinn telefon: 648 6125 telefaks: 641 0174 e-post: amende@hot.ee võõrkeeled: inglise, saksa, soome, vene

**Almar SEHVER****AAA Patendibüroo OÜ**

Tartu mnt 16  
10117 Tallinn  
pk 3926, 10509 Tallinn  
telefon: 660 5910, 660 5911  
telefaks: 660 5912  
e-post: aaa@aaa.ee  
<http://www.aaa.ee>  
võõrkeeled: inglise, vene

**Olga TREUFELDT****Patendibüroo TURVAJA OÜ**

Liivalaia 22  
10118 Tallinn  
telefon: 640 3109  
telefaks: 640 3105  
e-post: olga@turvaja.ee  
<http://www.turvaja.ee>  
võõrkeeled: inglise, vene

**Harald TEHVER****Patendibüroo TURVAJA OÜ**

Liivalaia 22  
10118 Tallinn  
telefon: 640 3109  
telefaks: 640 3105  
e-post: tehver@turvaja.ee  
<http://www.turvaja.ee>  
võõrkeeled: inglise, saksa, vene

**Enn URGAS****Patendibüroo TURVAJA OÜ**

Liivalaia 22  
10118 Tallinn  
telefon: 640 3109  
telefaks: 640 3105  
e-post: urgas@turvaja.ee  
<http://www.turvaja.ee>  
võõrkeeled: inglise, vene

**Mari TOOMSOO****Patendibüroo Käosaar & Co OÜ**

Peterburi tee 46, 11415 Tallinn  
telefon: 637 9484  
telefaks: 637 9485  
e-post: mari.toomsoo@kaosaar.ee  
<http://www.kaosaar.ee>  
võõrkeeled: inglise, soome

**Juta-Maris UUSTALU****OÜ LASVET**

Suurtüki 4a, 10133 Tallinn  
pk 3136, 10505 Tallinn  
telefon: 640 6600  
telefaks: 640 6604  
e-post: lasvet@lasvet.ee  
<http://www.lasvet.ee>  
võõrkeeled: inglise, vene

**LIST OF PATENT ATTORNEYS, REGISTERED IN  
THE ESTONIAN STATE REGISTER OF PATENT ATTORNEYS**  
(by 7 October 2005)

Register is established on September 1<sup>st</sup> 2001

**FIELD OF ACTIVITY: TRADEMARKS, INDUSTRIAL DESIGNS AND GEOGRAPHICAL INDICATIONS**

<b>Arno ANIJALG</b>	<b>USTERVALL Ltd.</b> Raekoja plats 16 51004 Tartu, Estonia P.O. Box 21 50002 Tartu, Estonia Phone: +372 744 1980 Fax: +372 744 1785 E-mail: anijalg@ustervall.ee Http://www.ustervall.ee German, Russian, Estonian	<b>Juhan HÄMMALOV</b>	<b>Intels Ltd.</b> Riia Str. 11-3 51010 Tartu, Estonia Phone: +372 742 0401 Fax: +372 742 0326 E-mail: intelses@estpak.ee English, German, Russian, Estonian
<b>Aivo ARULA</b>	<b>Patent Agency Käosaar &amp; Co</b> Tähe Str. 94 50107 Tartu, Estonia Phone: +372 738 3051 Fax: +372 738 3055 E-mail: info@kaosaar.ee Http://www.kaosaar.ee English, Russian, Estonian	<b>Uno JÄÄGER</b>	<b>Inseneribüroo Uneko Ltd.</b> Rüütli 51a 80010 Pärnu, Estonia Phone: +372 447 1021 Fax: +372 447 1001 GSM: +372 515 1844 E-mail: uno@estpak.ee English, Finnish, Russian, Estonian
<b>Martina BÖCKLER-LORVI</b>	<b>Lasvet Ltd.</b> P.O. Box 3136 10505 Tallinn, Estonia Phone: +372 640 6600 Fax: +372 640 6604 E-mail: lasvet@lasvet.ee Http://www.lasvet.ee English, Finnish, Estonian	<b>Sirje KAHU</b>	<b>USTERVALL Ltd.</b> Raekoja plats 16 51004 Tartu, Estonia P.O. Box 21 50002 Tartu, Estonia Phone: +372 744 1980 Fax: +372 744 1785 E-mail: skahu@ustervall.ee Http://www.ustervall.ee English, Russian, Estonian
<b>Indrek EELMETS</b>	<b>Lasvet Ltd.</b> P.O. Box 3136 10505 Tallinn, Estonia Phone: +372 640 6600 Fax: +372 640 6604 E-mail: lasvet@lasvet.ee Http://www.lasvet.ee English, Finnish, Russian, Estonian	<b>Lembit KALEV</b>	<b>Patent Bureau ROOSILLA Ltd.</b> Järveotsa Road 39-61 13520 Tallinn, Estonia Phone: +372 657 1722 +372 657 5381 Fax: +372 657 5381 GSM: +372 511 9951 E-mail: roosilla@roosilla.ee Http://www.roosilla.ee English, Russian, Estonian
<b>Alla HÄMMALOV</b>	<b>Intels Ltd.</b> Riia Str. 11-3 51010 Tartu, Estonia Phone: +372 742 0401 Fax: +372 742 0326 E-mail: intelses@estpak.ee English, Polish, Russian, Estonian	<b>Anneli KANG</b>	<b>Synest Ltd.</b> P.O. Box 977 13402 Tallinn, Estonia Phone: +372 660 9786 Fax: +372 660 9787 E-mail: anneli@synest.ee English, German, Russian, French, Finnish, Swedish, Estonian



- Urmast KAULER**      **Patendibüroo TURVAJA OÜ**  
 Liivalaia 22  
 10118 Tallinn, Estonia  
 Phone: +372 640 3109  
 Fax: +372 640 3105  
 E-mail: kauler@turvaja.ee  
 Http://www.turvaja.ee  
 English, Russian, Finnish,  
 Estonian
- Urmast KERNU**      **AAA Legal Services**  
 Tartu Road 16  
 10117 Tallinn, Estonia  
 P.O. Box 3926  
 10509 Tallinn, Estonia  
 Phone: +372 660 5910  
 +372 660 5911  
 Fax: +372 660 5912  
 E-mail: aaa@aaa.ee  
 Http://www.aaa.ee  
 English, German, Finnish,  
 Russian, Estonian
- Marina KESSELMAN**      **Kesna Ltd.**  
 Tedre Str. 77-52  
 10616 Tallinn, Estonia  
 Phone: +372 660 8068  
 Fax: +372 660 8069  
 E-mail: kesna@online.ee  
 English, German, Russian,  
 Estonian
- Ljubov KESSELMAN**      **Kesna Ltd.**  
 Tedre Str. 77-52  
 10616 Tallinn, Estonia  
 Phone: +372 660 8068  
 Fax: +372 660 8069  
 E-mail: kesna@online.ee  
 English, Russian, Estonian
- Heinu KOITEL**      **Patent- & Trademark Office  
 Koitel Ltd.**  
 Tartu Road 65  
 10115 Tallinn, Estonia  
 P.O. Box 1759  
 10902 Tallinn, Estonia  
 Phone: +372 603 3260  
 Fax: +372 603 3261  
 E-mail: koitel@koitel.ee  
 Http://www.koitel.ee  
 English, Finnish, Russian,  
 Estonian
- Raivo KOITEL**      **Patent- & Trademark Office  
 Koitel Ltd.**  
 Tartu Road 65  
 10115 Tallinn, Estonia  
 P.O. Box 1759  
 10902 Tallinn, Estonia  
 Phone: +372 603 3260  
 Fax: +372 603 3261  
 E-mail: koitel@koitel.ee  
 Http://www.koitel.ee  
 English, Finnish, Russian,  
 Estonian
- Mart Enn KOPPEL**      **Patent Bureau Koppel**  
 Kajaka 4-10  
 11317 Tallinn, Estonia  
 Phone: +372 677 4136  
 Fax: +372 677 4138  
 E-mail: info@koppelpb.com  
 Http://www.koppelpb.com  
 English, Russian, Finnish,  
 Estonian
- Heinrich KRUPP**      **Patendibüroo TURVAJA OÜ**  
 Liivalaia 22  
 10118 Tallinn, Estonia  
 Phone: +372 640 3109  
 Fax: +372 640 3105  
 E-mail: turvaja@turvaja.ee  
 Http://www.turvaja.ee  
 German, Russian, Estonian
- Jüri KÄOSAAR**      **Patent Agency Käosaar & Co**  
 Tähe Str. 94  
 50107 Tartu, Estonia  
 Phone: +372 738 3051  
 Fax: +372 738 3055  
 E-mail: info@kaosaar.ee  
 Http://www.kaosaar.ee  
 English, Russian, Estonian
- Kalev KÄOSAAR**      **Patent Agency Käosaar & Co**  
 Peterburi Road 46  
 11415 Tallinn, Estonia  
 Phone: +372 637 9484  
 Fax: +372 637 9485  
 E-mail:  
 kalev.kaosaar@kaosaar.ee  
 Http://www.kaosaar.ee  
 English, Russian, Estonian

- Reet MAASIKAMÄE Patent Bureau Kaitsepurus Ltd.**  
Mulla Str. 4-3  
10611 Tallinn, Estonia  
Phone: +372 673 9097  
+372 633 2798  
Fax: +372 677 4844  
E-mail: purus@online.ee  
purus@hot.ee  
Http://www.hot.ee/purus/  
English, Russian, Estonian
- Raivo MATSOO RM Hirvela Patent Bureau Ltd**  
Saku 15, 11314 Tallinn, Estonia  
Phone: +372 614 0816  
Fax: +372 614 0818  
E-mail: hirvela@hirvela.ee  
English, Russian, Estonian
- Elle MELLIK AAA Legal Services**  
Tartu Road 16  
10117 Tallinn, Estonia  
P.O. Box 3926  
10509 Tallinn, Estonia  
Phone: +372 660 5910  
+372 660 5911  
Fax: +372 660 5912  
E-mail: aaa@aaa.ee  
Http://www.aaa.ee  
English, Russian, Estonian
- Lembit MITT AAA Legal Services**  
Tartu Road 16  
10117 Tallinn, Estonia  
P.O. Box 3926  
10509 Tallinn, Estonia  
Phone: +372 660 5910  
+372 660 5911  
Fax: +372 660 5912  
E-mail: aaa@aaa.ee  
Http://www.aaa.ee  
English, Russian, Estonian
- Ott MOORLAT Moorlat & Co Ltd. Patent Bureau**  
P.O. Box 723  
12902 Tallinn, Estonia  
Phone: +372 655 0450  
+372 654 2844  
Fax: +372 654 2844  
E-mail: ott.moorlat@moorlat.ee  
Http://www.moorlat.ee  
English, Russian, Estonian
- Anfia MORNA**
- Tõnu NELSAS**
- Jüri OLT**
- Jaak OSTRAT**
- Villu PAVELTS**
- Toom PUNGAS**
- Patendibüroo TURVAJA OÜ**  
Liivalaia 22  
10118 Tallinn, Estonia  
Phone: +372 640 3109  
Fax: +372 640 3105  
E-mail: morna@turvaja.ee  
Http://www.turvaja.ee  
English, Russian, Estonian
- AAA Legal Services**  
Tartu Road 16  
10117 Tallinn, Estonia  
P.O. Box 3926  
10509 Tallinn, Estonia  
Phone: +372 660 5910  
+372 660 5911  
Fax: +372 660 5912  
E-mail: aaa@aaa.ee  
Http://www.aaa.ee  
English, Russian, Finnish, Estonian
- Patent Agency Käosaar & Co**  
Tähe Str. 94  
50107 Tartu, Estonia  
Phone: +372 738 3051  
Fax: +372 738 3055  
E-mail: info@kaosaar.ee  
Http://www.kaosaar.ee  
English, German, Finnish, Russian, Estonian
- Lasvet Ltd.**  
P.O. Box 3136  
10505 Tallinn, Estonia  
Phone: +372 640 6600  
Fax: +372 640 6604  
E-mail: lasvet@lasvet.ee  
Http://www.lasvet.ee  
English, German, Finnish, Russian, Estonian
- Lasvet Ltd.**  
P.O. Box 3136  
10505 Tallinn, Estonia  
Phone: +372 640 6600  
Fax: +372 640 6604  
E-mail: lasvet@lasvet.ee  
Http://www.lasvet.ee  
English, Finnish, Russian, Estonian
- Synest Ltd.**  
P.O. Box 977  
13402 Tallinn, Estonia  
Phone: +372 660 9786  
Fax: +372 660 9787  
E-mail: toom@synest.ee  
English, German, Finnish, Russian, Estonian

- Kaie PUUR**      **Patent Agency Käosaar & Co**  
Tähe Str. 94  
50107 Tartu, Estonia  
Phone: +372 738 3051  
Fax: +372 738 3055  
E-mail: info@kaosaar.ee  
Http://www.kaosaar.ee  
English, Russian, Estonian
- Harald TEHVER**      **Patendibüroo TURVAJA OÜ**  
Liivalaia 22  
10118 Tallinn, Estonia  
Phone: +372 640 3109  
Fax: +372 640 3105  
E-mail: tehver@turvaja.ee  
Http://www.turvaja.ee  
English, German, Russian,  
Estonian
- Riina PÄRN**      **Intels Ltd.**  
Riia Str. 11-3  
51010 Tartu, Estonia  
Phone: +372 742 0401  
Fax: +372 742 0326  
E-mail: intelses@estpak.ee  
English, Russian,  
Estonian
- Mari TOOMSOO**      **Patent Agency Käosaar & Co**  
Peterburi Str. 46  
11415 Tallinn, Estonia  
Phone: +372 637 9484  
Fax: +372 637 9485  
E-mail: mari.toomsoo@kaosaar.ee  
Http://www.kaosaar.ee  
English, Finnish, Estonian
- Tarmo ROSMAN**      **Rosman and Partners Ltd.**  
P.O. Box 652  
12602 Tallinn, Estonia  
Phone: +372 656 1450  
Fax: +372 656 1450  
E-mail: tarman@cc.ttu.ee  
German, English, Hungarian,  
Russian, Estonian
- Olga TREUFELDT**      **Patendibüroo TURVAJA OÜ**  
Liivalaia 22  
10118 Tallinn, Estonia  
Phone: +372 640 3109  
Fax: +372 640 3105  
E-mail: olga@turvaja.ee  
Http://www.turvaja.ee  
English, Russian, Estonian
- Arvo SALUMÄE**      **AMENDE Patent Agency Ltd.**  
Raua 65, 10152 Tallinn, Estonia  
Phone: +372 648 6125  
Fax: +372 641 0174  
E-mail: amende@hot.ee  
English, German, Finnish,  
Russian, Estonian
- Enn URGAS**      **Patendibüroo TURVAJA OÜ**  
Liivalaia 22  
10118 Tallinn, Estonia  
Phone: +372 640 3109  
Fax: +372 640 3105  
E-mail: urgas@turvaja.ee  
Http://www.turvaja.ee  
English, Russian, Estonian
- Almar SEHVER**      **AAA Legal Services**  
Tartu Road 16  
10117 Tallinn, Estonia  
P.O. Box 3926  
10509 Tallinn, Estonia  
Phone: +372 660 5910  
+372 660 5911  
Fax: +372 660 5912  
E-mail: aaa@aaa.ee  
Http://www.aaa.ee  
English, Russian, Estonian
- Juta-Maris UUSTALU**      **Lasvet Ltd.**  
P.O. Box 3136  
10505 Tallinn, Estonia  
Phone: +372 640 6600  
Fax: +372 640 6604  
E-mail: lasvet@lasvet.ee  
Http://www.lasvet.ee  
English, Russian, Estonian